

AHRI Standard 210/240 with Addendum 1

2017 Standard for

**Performance Rating
of Unitary Air-conditioning
& Air-source Heat Pump
Equipment**



**AIR-CONDITIONING, HEATING,
& REFRIGERATION INSTITUTE**

we make life better®

2311 Wilson Boulevard, Suite 400
Arlington, VA 22201, USA

www.ahrinet.org

PH 703.524.8800

FX 703.562.1942

AHRI STANDARD 210/240-2017 WITH ADDENDUM 1,

Performance Rating of Unitary Air-conditioning & Air-source Heat Pump Equipment

April 2019

Addendum 1 (dated April 2019) of AHRI Standard 210/240-2017, “Changes to AHRI Standard 210/240-2017” is provided as follows. To avoid confusion, the following changes have been incorporated into the already published 2017 version of AHRI Standard 210/240. Addendum deletions are shown with ~~strikethrough~~ and addendum additions are shown by shading in gray.

The changes are to the sections listed below.

1. Revisions to Section 3. Definitions and Acronyms

3.1.23 *Indoor Unit.* A separate assembly of a Split System that includes both an arrangement of refrigerant-to-air heat transfer coil(s) for transfer of heat between the refrigerant and the indoor air and a condensate drain pan. An Indoor Unit may or may not include sheet metal or plastic parts not part of external cabinetry to direct/route airflow over the coil(s), a cooling mode expansion device, external cabinetry, air temperature sensing device and an integrated indoor blower (i.e. a device to move air including its associated motor). A separate designated air mover that may be a furnace or a Modular Blower may be considered to be part of the Indoor Unit. A Service Coil is not an Indoor Unit.

3.1.25 *Latent Cooling Capacity.* The rate, expressed in Btu/h, at which the equipment removes latent heat (reduces the moisture content) of the air passing through it under specified conditions of operation.

3.1.27 *Multiple Capacity (Multiple Stage) Compressor.* A compressor having three or more pre-determined discrete stages of capacity ~~that has neither an inverter nor variable frequency drive~~ or a group of compressors with three or more stages of capacity.

3.1.36 *Oil Recovery Mode.* An automatic system operation that returns oil to the compressor crank case when the control system determines that the oil level in the Outdoor Unit is low.

3.1.44 *Sensible Cooling Capacity.* The rate, expressed in Btu/h, at which the equipment lowers the dry-bulb temperature (removes sensible heat) of the air passing through it under specified conditions of operation.

3.1.54 *System Controls.* These devices may include but are not limited to:

3.1.54.1 An integral network operations and communications system with sensors to monitor the status of items such as temperature, pressure, oil, refrigerant levels and fan speed.

3.1.54.2 A micro-processor, algorithm-based control scheme to: (1) communicate with a managed variable capacity compressor, fan speed of Indoor Units, fan speed of the Outdoor Unit, solenoids,

various accessories; (2) manage metering devices; and (3) concurrently operate various parts of the system.

3.1.54.3 Regulation of system efficiency and refrigerant flow through an engineered distributed refrigerant system to conduct zoning operations, matching capacity to the load in each of the zones.

3.1.59 *Total Cooling Capacity.* The sum of Sensible and Latent Capacity the equipment can remove from the conditioned space in a defined interval of time in Btu/h (Net Capacity in the cooling mode).

3.1.60 *Total Heating Capacity.* The amount of Sensible Capacity the equipment can add to the conditioned space in a defined interval of time in Btu/h (Net Capacity in the heating mode).

3.1.61 *Total Power.* The sum of the power consumed by all components of a system, including the power consumed by the compressor(s), indoor supply fan motor(s), outdoor condenser fan motor(s), System Controls, factory installed condensate pumps and other devices required for normal operating modes.

3.1.70.5 *Nominal Compressor Speed (Nom).* A heating mode compressor speed equivalent to no lower than Full Compressor Speed in cooling, under the condition that H12 rated capacity is less than A2 rated Cooling Capacity.

Note: Nominal Compressor Speed is not directly connected to Nominal Capacity.

2. Revisions to Section 5. Test Requirements

5.1.1 Air-cooled units shall be tested in accordance with ANSI/ASHRAE Standard 37 as amended by Appendix D and Appendix E and ANSI/ASHRAE Standard 116 as amended by Appendix F. Water-cooled and Evaporatively-cooled Air-conditioner shall be tested in accordance with ANSI/ASHRAE Standard 37 as amended by Appendix E. In ANSI/ASHRAE Standards 37 and 116, wherever terms “may” or “should” are used, they shall be taken to be mandatory requirements.

5.1.2 *Variable Speed Equipment.* A means to override the controls of the Variable Speed System under test shall be provided by the manufacturer that claims the performance of the particular system, when needed, prior to initial set-up during laboratory testing.

Piping length beyond the requirement (X), ft	Cooling Capacity Correction Factor, F _{CCC}
3.3 < X ≤ 20	1.01
20 < X ≤ 40	1.02
40 < X ≤ 60	1.03
60 < X ≤ 80	1.04
80 < X ≤ 100	1.05
100 < X ≤ 120	1.06

Note:

- Due to the refrigerant line lengths required in the test setup as determined by laboratory personnel, a correction factor shall be applied to normalize the measured cooling capacity
- The piping length X is the additional refrigerant piping length above the minimum described in Section 5.1.6.1 that has been applied to at least 33% (minimum of 2) of the Indoor Units in the testing configuration.
- In all cases, the absolute minimum length necessary to physically connect the system shall be used.
- Average piping length in addition to the minimum in Table 4 (X), ft for at least 33% (minimum of 2) of the Indoor Units. (the length (X) is the differential distance between the actual piping length between the Outdoor Unit and the Indoor Unit and the minimum requirement)

Table 4. Refrigerant Line Length Correction Factors^{1, 2, 3} (Continued)

- ~~2. The piping length X is the cumulative additional line length above the minimum as specified in Section 5.1.6.1.~~
- ~~3. If tubing is not provided by the manufacturer, the absolute minimum length necessary to physically connect the system shall be used~~

5.1.7.1 Except for mix-matched systems covered in Section 5.1.7.2 and Multi-split Systems, in the event of conflicting information between charging instructions, the Outdoor Unit label prevails, followed by Installation Instructions of the Outdoor Unit, followed by the Installation Instructions of the Indoor Unit. For Multi-split systems, the hierarchy is Outdoor Unit installation instructions prevail, followed by the Outdoor Unit label, followed by the Indoor Units' installation instructions. Conflicting information is defined as multiple conditions given for charge adjustment where all conditions specified cannot be met. In such instances of conflicting information, follow the hierarchy in Table 5 for priority. Unless the manufacturer specifies a different charging tolerance, the tolerances specified in Table 5 shall be used for all products.

Table 5. Test Condition Tolerance for Charging Hierarchy

Fixed Orifice			Expansion Valve		
Priority	Method	Tolerance	Priority	Method	Tolerance
1	Super-heat	± 2.0 °F	1	Sub-cooling	10% of the Target Value; No less than ± 0.5 °F, No more than ± 2.0 °F
2	High Side Pressure or Saturation Temperature	± 4.0 psi or ± 1.0 °F	2	High Side Pressure or Saturation Temperature	± 4.0 psi or ± 1.0 °F
3	Low Side Pressure or Saturation Temperature	± 2.0 psi or ± 0.8 °F	3	Low Side Pressure or Saturation Temperature	± 2.0 psi or ± 0.8 °F
4	Low Side Temperature	± 2.0 °F	4	Approach Temperature	± 1.0 °F
5	High Side Temperature	± 2.0 °F	5	Charge Weight	0.5% or 1.0 oz, whichever is greater ± 2.0 oz
6	Charge Weight	± 2.0 oz			

5.4 Oil Recovery. The Oil Recovery Mode shall be activated during testing. If Oil Recovery prevents a Steady-state test use the transient test procedure as described in Section 8.8.3 (except Section 8.8.3.3) of ANSI/ASHRAE Standard 37, with the revisions in the following section:

5.4.1 For tests that cannot reach Steady-state because of Oil Recovery, Section 8.8.3 (except Section 8.8.3.3) of ANSI/ASHRAE Standard 37 shall be modified by replacing all mentions of “defrost” with “Oil Recovery”, replacing all mentions of “Heat Pump” with “system” and replacing all mentions of “heating” with “conditioning”. The test tolerances specified in Table 2 of ANSI/ASHRAE Standard 37 for “heat portion” under “heat with frost” shall be satisfied when conducting the tests. The test tolerance parameters included in Table 2 of ANSI/ASHRAE Standard 37 shall be sampled throughout the preconditioning and data collection period. For the purpose of evaluating compliance with the specified test tolerances, the dry bulb temperature of the air entering the indoor side and the outdoor side, and the water vapor content of the air entering the outdoor side shall be sampled at least every minute. All other parameters shall be sampled at equal intervals that span five minutes or less.

3. Revisions to Section 6. Rating Requirements

Table 7. Required Tests ¹										
Test Name				Product Type						
New Version	Former Version			Air-cooled					Evaporatively-cooled Air-conditioner	Water-cooled Air-conditioner
	Single	Two	Variable	Single Stage System	Two-stage System	Two-stage Northern	Variable Stage System	Triple-capacity Northern		
Cooling Mode ²										
A _{Full}	A	A ₂	A ₂	R	R	R	R	R	R	R
B _{Full}	B	B ₂	B ₂	R	R	R	R	R		
B _{Low}	-	B ₁	B ₁		R ⁴		R	R ⁴		
C _{Full}	C	C ₂	C ₂	O ³	O ³	O ³		O ³		
C _{Low}	-	C ₁	C ₁		O ³			O ³		
D _{Full}	D	D ₂	D ₂	O ³	O ³	O ³		O ³		
D _{Low}	-	D ₁	D ₁		O ³			O ³		
E _{Int}	-	-	E _V				R			
F _{Low}	-	F ₁	F ₁		R		R	R		
G _{Low}	-	-	G ₁				O ³			
I _{Low}	-	-	I ₁				O ³			
Cooling Mode Operation Tests ^{2,4,6}										
Voltage Tolerance				R	R	R	R	R	R	R
Low Temperature Cooling				R	R	R	R	R	R	R
Insulation Efficiency				R	R	R	R	R	R	R
Condensate Disposal				R	R	R	R	R	R	R
Maximum Operating Conditions				R	R	R	R	R	R	R
Heating Mode ⁵										
H0 _{Low}	-	H0 ₁	H0 ₁		R	R	R	R		
H0C _{Low}	-	-	H0C ₁				O ⁶			
H1 _{Full}	H1	H1 ₂	H1 ₂	R	R	R	O	R		
H1 _{Low}	-	H1 ₁	H1 ₁		R	R	R	R		
H1C _{Full}	H1C	H1C ₂	H1C ₂	O ⁶	O ⁶	O ⁶	O ⁶	O ⁶		
H1C _{Low}	-	H1C ₁	H1C ₁		O ⁶	O ⁶	O ⁶	O ⁶		
H1 _{Nom}	-	-	H1 _N				R			
H2 _{Boost}	-	-	-					O		
H2 _{Full}	H2	H2 ₂	H2 ₂	R	R	R	O	R		
H2 _{Low}	-	H2 ₁	H2 ₁		O ⁷	O ⁷		O ⁷		
H2 _{Int}	-	-	H2 _V				R			
H3 _{Full}	H3	H3 ₂	H3 ₂	R	R	R	R	R		
H3 _{Low}	-	H3 ₁	H3 ₁		R ⁸	R ⁸		R ⁸		
H3 _{Boost}	-	-	-					R		
H3C _{Boost}								O		
H4 _{Boost}	-	-	-					R		
Heating Mode Operation Tests ^{3,4,6}										
Voltage Tolerance				R	R	R	R	R		
Maximum Operating Conditions				R	R	R	R	R		
Notes:										
1. "R" means Required, "O" means Optional, and a blank cell indicates test is not applicable for the given product type.										
2. Required for any unit that has a cooling mode function.										
3. Refer to Section 6.1.3.1.										
4. See AHRI Unitary Small Equipment Operation Manual for details.										
5. Required for any unit that has a heating mode function.										
6. Refer to Section 6.1.3.2.										

Table 7. Required Tests¹ (Continued)

7. Not necessary if low-capacity compressor heat pump performance at outdoor temperatures less than 37.0°F is not needed to calculate the HSPF per Section 11. Also, instead of testing, the H2Low capacity and electrical power may be approximated based on H1Low and H3Low tests per Section 6.1.3.4.
8. Required only if the heat pumps performance when operating at low compressor capacity and outdoor temperatures less than 37.0°F is needed to complete the HSPF calculation per Section 11.

Table 8. Test Conditions for Air-cooled Products (Continued)

Notes:

1. Test condition tolerances are defined within ASHRAE Standard 37, ASHRAE Standard 116 Table 3b for cyclic, and Section 8.7 of this standard.

4. Revisions to Section 7. Minimum Data Requirements for Published Ratings

7.3 Latent Cooling Capacity Designation. The Latent Cooling Capacity used in published specifications, literature or advertising, controlled by the manufacturer, for equipment rated under this standard, total or Sensible Cooling Capacity shall be expressed consistently in either Gross Capacity or Net Capacity in one or more of the following forms:

- 7.3.1 Sensible Cooling Capacity / total Net Capacity ratio and total Net Capacity
- 7.3.2 Latent Cooling Capacity and total Net Capacity
- 7.3.3 Sensible Cooling Capacity and total Net Capacity

5. Revisions to Section 11. Calculations

11.1 Individual Test Calculations. For this section subscript lowercase “x” is used for the individual test measurement. For example, the symbol for Total Cooling Capacity for the A_{Full} test is $q_{\text{tc},A,\text{Full}}$, in this calculation section q_x is used, where “x” is equal to A_{Full}. For all capacities calculated in Section 11, round the calculated value to the nearest integer. For all Degradation Coefficients, round the calculated value to the nearest 0.01. If the calculated Degradation Coefficient is negative, set the Degradation Coefficient equal to zero.

11.1.1 Cooling Steady State Net ~~Total~~ Capacity.

11.1.1.1 Total Cooling Capacity (Indoor Air Enthalpy Method). The Net ~~total~~ Capacity for all steady state cooling tests shall be calculated using Equation 11.2 for Blower Coil Systems or using Equation 11.3 for Coil-only Systems.

11.1.1.2 Total Cooling Capacity (Outdoor Air Enthalpy Method). The Net ~~total~~ Capacity for all steady state cooling tests shall be calculated using Equation 11.7 for units that do re-evaporate drained condensate from the indoor coil or Equation 11.8 for units that do not re-evaporate drained condensate from the indoor coil.

11.1.1.3 Total Cooling Capacity (Refrigerant Enthalpy Method). The Net ~~total~~ Capacity for all steady state cooling tests shall be calculated as follows. See Section D6.3.2 of this Standard for information about mass flow ratio, x .

11.1.4 Cooling Cyclic Net ~~Total~~ Capacity. The Net ~~total~~ Capacity for all cyclic cooling tests (tests D and I) shall be calculated as follows. $Q_{\text{mi},c,\text{pa}}$, $[\dot{v}]_{\text{n}}$, $P_{\text{(fan,x)}}$, and W_{n} shall be the average values recorded during the corresponding dry coil steady state tests (tests C and G).

11.1.7 Heating Steady State Net ~~Total~~ Capacity.

11.1.7.2 Total Heating Capacity (Outdoor Air Enthalpy Method). The Net total Capacity for all steady state heating tests shall be calculated as follows.

11.1.7.3 Total Heating Capacity (Refrigerant Enthalpy Method). The Net total Capacity for all steady state heating tests shall be calculated as follows.

11.1.10 Heating Cyclic Net Total Capacity. The Net total Capacity for all cyclic heating tests shall be calculated using Equation 11.39. Q_{mi, c_pa} , $[\dot{v}]_n$, and W_n shall be the values recorded during the corresponding steady state tests.

$$P_{Low}(t_j) = P_{F,Low} + \left\{ \frac{\dot{P}_{B,Low} P_{B,Low} - P_{F,Low}}{82-67} \right\} \cdot (t_j - 67) \quad 11.63$$

$$P_{Full}(t_j) = P_{B,Full} + \left\{ \frac{\dot{P}_{A,Full} P_{A,Full} - P_{B,Full} \dot{P}_{B,Full}}{95-82} \right\} \cdot (t_j - 82) \quad 11.65$$

$$q(t_j) = CLF^{Low}(t_j) \cdot \dot{q}_{Low}(t_j) \cdot n_j \quad 11.66$$

$$E(t_j) = \frac{CLF^{Low}(t_j) \cdot P_{Low}(t_j) \cdot n_j}{PLF^{Low}(t_j)} \quad 11.67$$

$$CLF^{Low}(t_j) = \frac{BL(t_j)}{\dot{q}_{Low}(t_j)} \quad 11.68$$

$$PLF^{Low}(t_j) = 1 - C_D^{c,Low} \cdot [1 - CLF^{Low}(t_j)] \quad 11.69$$

The Total Cooling Capacity and energy at an intermediate speed for each bin temperature shall be calculated as follows, for individual bin calculation (see Section 11.2.3.1.2).

$$q(t_j) = BL(t_j) \cdot n_j \quad 11.91$$

$$E(t_j) = \frac{\dot{q}_{Int-Bin}(t_j)}{EER_{Int-Bin}(t_j)} \cdot n_j \quad 11.92$$

Intermediate steady state capacity for each bin temperature, $\dot{q}_{Int-Bin}(t_j)$, shall be calculated as follows, for intermediate compressor speed capacity rate, power and efficiency (Equations 11.93 to 11.106).

$$EER_{Int-Bin}(t_j) = a + b \cdot t_j + c \cdot t_j^2 \quad 11.99$$

$$a = EER_{FullLow}(t_{II}) - b \cdot t_{II} - c \cdot t_{II}^2 \quad 11.100$$

$$b = \frac{EER_{Low}(t_I) - EER_{Full}(t_{II}) - d \cdot [EER_{Low}(t_I) - EER_{Int-Bin}(t_{vc})]}{t_I - t_{II} - d \cdot [t_I - t_{vc}]} \quad 11.101$$

11.2.1.3.2 Case II - Building load can be matched by modulating the compressor speed between low speed and full speed, $\dot{q}_{Low}(t_j) < BL(t_j) < \dot{q}_{Full}(t_j)$, where $(t_I < t_j < t_{II})$. Use Equations 11.91 and 11.92 to calculate the Total Cooling Capacity and energy calculations for each bin.

11.2.1.3.3 *Case III - Building load is equal to or greater than unit capacity at full stage.* $BL(t_j) \geq \dot{q}_{Full}(t_j)$, where $(t_j \geq t_{II})$. Use the equations in Section 11.2.1.2.4 to calculate the Total Cooling Capacity and energy for each bin.

$$\text{For } t_j > t_{ON} \text{ and } \frac{\dot{q}_{Full}(t_j)}{3.412 \cdot P_{Full}(t_j)} \geq 1$$

$$\delta(t_j) = 1 \quad 11.122$$

$$\text{For } t_j \geq t_{ON} \text{ and } \frac{\dot{q}_{Full}(t_j)}{3.412 \cdot P_{Full}(t_j)} \geq 1$$

$$\delta''(t_j) = 1 \quad 11.161$$

11.2.2.3 *Variable Speed System.* HSPF for a Variable Speed System shall be calculated using Equation 11.133, except as noted below, substituting \dot{q}_x^{calc} for \dot{q}_x and P_x^{calc} for P_x and substituting $\dot{q}_{H1,Nom}$ for $\dot{q}_{H1,Full}$ in Equations 11.111 to 11.114. See Figure 10 for a graphical representation.

$$\text{For } t_j \geq -45^\circ F \text{ or } t_j \leq 17^\circ F$$

$$P_{Full}(t_j) = P_{H3,Full} + [P_{H1,Full} - P_{H3,Full}] \cdot \frac{t_j - 17}{47 - 17} \quad 11.189$$

$$\dot{q}_{Full}(t_j) = \dot{q}_{H3,Full} + [\dot{q}_{H1,Full} - \dot{q}_{H3,Full}] \cdot \frac{t_j - 17}{47 - 17} \quad 11.190$$

$$\frac{P_{Full}(t_j) \dot{P}_{Full}(t_j)}{35 - 17} = P_{H3,Full} + [P_{H2,Full} P_{H2,Full} - P_{H3,Full} \dot{P}_{H3,Full}] \cdot \frac{t_j - 17}{35 - 17} \quad 11.191$$

6. Revisions to Section 12. Symbols, Subscripts and Superscripts

$\dot{q}_{thi,x}$	Heating Steady State Net Total Heating Capacity for test x – indoor side, Btu/h
$\dot{q}_{tho,x}$	Heating Steady State Net Total Heating Capacity for test x – outdoor side, Btu/h

7. Revisions to APPENDIX C. CERTIFICATION OF LABORATORY FACILITIES USED TO DETERMINE PERFORMANCE OF UNITARY AIR-CONDITIONING & AIR-SOURCE HEAT PUMP EQUIPMENT – INFORMATIVE

C5.1.6.1 *Sensible Cooling Capacity Energy Balance.* B_{SH} , the Sensible Cooling Capacity energy balance, is defined as follows:

C5.1.6.2.2.4 The instrument induced latent capacity shall be calculated using ANSI/ASHRAE Standard 37 Section 7.3.3.1. The value shall be reported and the Instrument Induced Latent/Sensible Cooling Capacity Ratio shall be calculated, L/S, and reported as a percentage. If this ratio exceeds 5% an investigation into the humidity measurement error should take place.

8. Revisions to APPENDIX D. SECONDARY CAPACITY CHECK REQUIREMENTS – NORMATIVE

D5.1.1.1 Excluded from Section D5.1.1 requirements is any Split System with an expansion device located upstream of the liquid line mass flow meter (i.e. systems with a cooling expansion device in the Outdoor Unit).

D5.1.1.2 This method shall not be used on specific tests if ANSI/ASHRAE Standard 37 Section 7.5 cannot be met. The air enthalpy method shall be substituted in these cases.

D5.1.2 The absolute value of HB shall be 4.0% or less on all steady state tests utilizing the refrigerant mass flow method, except for H3 or any inverter at other than full speed which is exempt from this requirement if:

D5.1.2.1 The absolute values of HB for Tests B_{Full} and H1_{Full} are 3.0% or less, and

~~**D5.1.3** Excluded from Section D5.1.1 requirements is any Split System with an expansion device located upstream of the liquid line mass flow meter (i.e. systems with a cooling expansion device in the Outdoor Unit).~~

~~**D5.1.4** This method shall not be used on specific tests if ANSI/ASHRAE Standard 37 Section 7.5 cannot be met. The air enthalpy method shall be substituted in these cases.~~

D7.2.4 When thermocouples (TCs) are used for measurement of refrigerant temperature by application to the outside of tubing, the requirements of Section D6.2.3 shall be met.

9. Revisions to APPENDIX E. ANSI/ASHRAE STANDARD 37 CLARIFICATIONS/EXCEPTIONS – NORMATIVE

E7.2.1 Install an interconnecting duct between the indoor coil outlet plenum and the airflow measuring apparatus. The cross-sectional flow area of the interconnecting duct shall be equal to or greater than the flow area of the outlet plenum or the common duct used when testing Non-ducted Systems having multiple indoor coils. If needed, use adaptor plates or transition duct sections to allow the connections. To minimize leakage, tape joints within the interconnecting duct (and the outlet plenum). Construct or insulate the entire flow section with thermal insulation having a nominal overall resistance (R-value) of at least ~~25~~19 hr·ft²·°F/Btu.

E8.1 Add the following section: “*Indoor coil inlet and outlet duct connections.* Insulate and/or construct the outlet plenum and the inlet plenum with thermal insulation having a nominal overall resistance (R-value) of at least ~~25~~19 hr·ft²·°F/Btu”.

E13.2.1 *Air Sampling Device.* A combination of Air Sampling Tree(s), conduit, fan and Aspirating Psychrometer or Dew-point Hygrometer used to determine dry-bulb temperature and moisture content of an air sample from critical locations.

E13.2.1.1 *Air Sampling Tree.* The Air Sampling Tree is an assembly consisting of a manifold with several branch tubes with multiple sampling holes that draws an air sample from a critical location from the unit under test (e.g. indoor air inlet, indoor air outlet, outdoor air inlet, etc.). See Section E4.4 for design requirements.

E13.2.1.2 *Aspirating Psychrometer.* A piece of equipment with a monitored airflow section that draws uniform airflow through the measurement section and has probes for measurement of air temperature and humidity. See Section E4.5 for design requirements.

E13.2.1.3 *Dew-point Hygrometer.* An instrument used to determine the humidity of air by detecting visible condensation of moisture on a cooled surface.

10. New appendix: APPENDIX K. DOE APPENDIX M1 – INFORMATIVE:

The new Appendix K has been added for information only to the user of this version of AHRI Standard 210/240, several changes to the federal test procedure will become effective January 1, 2023. Content of Appendix K can be found in pages 129 through 131 of this standard.

IMPORTANT

SAFETY DISCLAIMER

AHRI does not set safety standards and does not certify or guarantee the safety of any products, components or systems designed, tested, rated, installed or operated in accordance with this standard/guideline. It is strongly recommended that products be designed, constructed, assembled, installed and operated in accordance with nationally recognized safety standards and code requirements appropriate for products covered by this standard/guideline.

AHRI uses its best efforts to develop standards/guidelines employing state-of-the-art and accepted industry practices. AHRI does not certify or guarantee that any tests conducted under its standards/guidelines will be non-hazardous or free from risk.

Note:

This standard supersedes AHRI Standard 210/240-2017.

AHRI CERTIFICATION PROGRAM PROVISIONS

Scope of the Certification Program

The Certification Program includes all Unitary Air-conditioning and Unitary Air-source Heat Pump equipment rated below 65,000 Btu/h at AHRI Standard Rating Conditions (Cooling).

Certified Ratings

The following Certification Program ratings are verified by test:

Unitary Air-Conditioners

- A. Air-cooled
 - 1. AHRI Standard Rating Cooling Capacity, Btu/h
 - 2. Energy Efficiency Ratio (EER_{A,Full}), Btu/(W·h)
 - 3. Seasonal Energy Efficiency Ratio (SEER), Btu/(W·h)
- B. Water-cooled and Evaporatively-cooled
 - 1. AHRI Standard Rating Cooling Capacity, Btu/h
 - 2. Energy Efficiency Ratio (EER), Btu/(W·h)
 - 3. Integrated Energy Efficiency Ratio (IEER), Btu/(W·h)

Unitary Air-source Heat Pumps

Air-cooled

- 1. AHRI Standard Rating Cooling Capacity, Btu/h
- 2. Energy Efficiency Ratio (EER_{A,Full}), Btu/(W·h)
- 3. Seasonal Energy Efficiency Ratio (SEER), Btu/(W·h)
- 4. High Temperature Heating Standard Rating Capacity, Btu/h
- 5. Region IV Heating Seasonal Performance Factor, HSPF, using minimum Design Heating Requirement, Btu/(W·h)

Conformance to the requirements of the Maximum Operating Conditions Test, Voltage Tolerance Test, Low-Temperature Operation Test (Cooling), Insulation Effectiveness Test (Cooling), and Condensate Disposal Test (Cooling), as outlined in Section 8, are also verified by test. Refer to the USAC/USHP Certification Program Operation Manual for more information regarding the AHRI Certification Program.

FOREWORD

AHRI issued a call for members (AHRI Update, August 15, 2013) to join the Unitary Small Equipment Engineering Committee Technical Committee (USE EC TC) to revise AHRI Standard 210/240. Over the course of years and many meetings, the USE EC TC suggested many substantive changes to the standard with three primary intentions. The first intention is to improve the repeatability and accuracy of the psychrometric testing, the second to implement changes addressing technology improvements in both product and laboratories and finally to make the standard more readable and user friendly. Several of these changes were submitted to the U.S. Department of Energy (DOE) in the docket for test procedure rulemaking EERE-2009-TP-0004.

Several steps are being taken to improve testing, starting with Informative Appendix C is added as a reference for calibration of laboratory sub-systems. This process is currently mandatory for any independent laboratory which conducts tests for the AHRI USAC or USHP Certification Programs. The intention is to make this process normative with the next revision of AHRI Standard 210/240. Further, normative Appendix D is added for improvement in consistency of refrigerant enthalpy and outdoor air enthalpy secondary capacity checks. Additions and modifications of ASHRAE Standard 37 and ASHRAE Standard 116 Methods of Test (MOT) are provided in normative Appendices E and F. These changes add clarification and specification where both independent and manufacturer testing laboratories have found needed revisions and are a holding spot until the current ASHRAE SPC 37 Committee can complete its work to revise and combine those MOTs. It is expected these two appendices will be removed in the next revision cycle after the next update of ASHRAE Standard 37 (with ASHRAE Standard 116 rolled in), which is expected in 2018.

As product and testing laboratory technology has advanced, the USE EC TC found the need to provide clarification on several issues addressing new technology such as variable speed compressors, variable speed air moving systems, laboratory measurement processes, etc. Further, some changes in this 2017 version of the standard are intended to be more representative of product as it operates today. This 2017 version is modified to implement modifications, including those mentioned above, that have been adopted by the U.S. Department of Energy (DOE) in their final rules for test procedures, published June 2016 (81 FR 36991), August 2016 (81 FR 55111) and January 2017 (82 FR 1426). The user of AHRI Standard 210/240 is cautioned that the DOE has not removed the following change, removed from this version of AHRI Standard 210/240:

- ✦ Three test variations were removed as there were no known products being manufactured. One variation was for “triple split” air-conditioners or heat pumps, the other was for single speed product having variable airflow rates based on outdoor ambient, and constant RPM indoor fans.

As the standard grew to address new technologies over the years (primarily two-stage and variable-stage systems), for many users the standard had become cumbersome and confusing. As an example, the same test conditions (95 °F outdoor dry bulb, 80 °F indoor dry bulb and 67 °F indoor wet bulb) existed for multiple types of systems, but was known by different names and acronyms depending upon the system type. The USE EC TC combined test condition specifications from 11 different tables with differing names/symbols into 3 simplified tables with common names/symbols. The committee also chose to put all the necessary formulas for calculation of efficiency points into a common section of this standard (using the new harmonized symbols/nomenclature) so the user would not need to flip between multiple standards.

TABLE OF CONTENTS

SECTION	PAGE
Section 1. Purpose.....	1
Section 2. Scope.....	1
Section 3. Definitions and Acronyms	1
Section 4. Classifications	10
Section 5. Test Requirements	13
Section 6. Rating Requirements.....	18
Section 7. Minimum Data Requirements for Published Ratings	41
Section 8. Operating Requirements	42
Section 9. Marking and Nameplate Data	44
Section 10. Conformance Conditions	44
Section 11. Calculations.....	44
Section 12. Symbols, Subscripts and Superscripts	73

TABLES

Table 1. Classification of Unitary Air-conditioners.....	11
Table 2. Classification of Unitary Air-source Heat Pumps	12
Table 3. Classification of Multi-split Systems	13
Table 4. Refrigerant Line Length Correction Factors.....	14
Table 5. Test Condition Tolerance for Charging Hierarchy.....	16
Table 6. Informative Guidance for Using AHRI Standard 210/240	19
Table 7. Required Tests	20
Table 8. Test Conditions for Air-cooled Products	21

TABLES (Cont'd)

Table 9.	Test Conditions for Water-cooled and Evaporatively-cooled Air-conditioner Products	22
Table 10.	Values of Standard Capacity Ratings.....	22
Table 11.	Minimum External Static Pressure for Ducted Systems Tested with an Indoor AMS Installed	26
Table 12.	IEER Part Load Rating Conditions.....	32
Table 13.	Tolerance on Part Load Percent Load.....	34
Table 14.	Application Rating Conditions for I-P Standards	37
Table 15.	t Statistic	39
Table 16.	Fractional Bin Hours to Be Used in Calculation of SEER.....	52
Table 17.	Standardized Design Heating Requirements (Btu/h)	59
Table 18.	Distribution of Fractional Heating Hours in Temperature Bins, Heating Load Hours, and Outdoor Design Temperature for Different Climatic Regions.....	59

FIGURES

Figure 1.	Example Revised Part Load Ambient Conditions for Interpolation.....	33
Figure 2.	Voltage Tolerance Test Power Interrupt Procedure.....	43
Figure 3.	Schematic of a Single-speed System Operation in the Cooling Mode	51
Figure 4.	Cooling Load Hours (CLH _A) for the United States	52
Figure 5.	Schematic of a Two-speed System Operation in the Cooling Mode.....	53
Figure 6.	Schematic of a Variable Speed System Operation in the Cooling Mode	56
Figure 7.	Heating Load Hours (HLH _A) for the United States	60
Figure 8.	Schematic of a Single-speed Heat Pump Operation	63
Figure 9.	Schematic of a Two-speed Heat Pump Operation	64
Figure 10.	Schematic of a Variable Speed Heat Pump Operation	68

APPENDICES

Appendix A.	References – Normative.....	79
Appendix B.	References – Informative	80
Appendix C.	Certification of Laboratory Facilities Used to Determine Performance of Unitary Air-conditioning & Air-source Heat Pump Equipment – Informative.....	81
Appendix D.	Secondary Capacity Check Requirements - Normative	98
Appendix E.	ANSI/ASHRAE Standard 37-2009 Clarifications/Exceptions – Normative	105
Appendix F.	ANSI/ASHRAE Standard 116-2010 Clarifications/Exceptions – Normative	114
Appendix G.	Unit Configuration for Standard Efficiency Determination - Normative	120
Appendix H.	Examples of IEER Calculations - Informative	123
Appendix I.	Off-mode Testing - Normative	124
Appendix J.	Verification Testing - Normative.....	128
Appendix K.	DOE Appendix M1 – Informative	129

FIGURES FOR APPENDICES

Figure C1.	Passive Pressure Drop Device	92
Figure E1.	Configurations for Manifolding the Static Pressure Taps.....	107
Figure E2.	Typical Air Sampling Tree	111
Figure E3.	Aspirating Psychrometer.....	111

TABLES FOR APPENDICES

Table C1.	Nozzle Combination Tests.....	85
Table C2.	Nominal Dimensions for Passive Pressure Drop Device.....	91
Table E1.	Pressure Measurement Location.....	109
Table J1.	Acceptance Criteria.....	128

Table K1. New Table 18. Generalized Climate Region Information 130

PERFORMANCE RATING OF UNITARY AIR-CONDITIONING AND AIR-SOURCE HEAT PUMP EQUIPMENT

Section 1. Purpose

1.1 Purpose. The purpose of this standard is to establish the following for Unitary Air-conditioners and Unitary Air-source Heat Pumps: definitions, classifications, test requirements, rating requirements, operating requirements, minimum data requirements for Published Ratings, marking and nameplate data, and conformance conditions.

1.1.1 Intent. This standard is intended for the guidance of the industry, including manufacturers, engineers, installers, contractors and users.

1.1.2 Review and Amendment. This standard is subject to review and amendment as technology advances.

Section 2. Scope

2.1 Scope. This standard applies to factory-made Unitary Air-conditioners and Unitary Air-source Heat Pumps with capacities less than 65,000 Btu/h as defined in Section 3.

2.1.1 Energy Source. This standard applies only to electrically operated, vapor compression refrigeration systems.

2.2 Exclusions. This standard does not apply to the rating and testing of:

2.2.1 Heat operated air-conditioning/heat pump equipment.

2.2.2 Packaged Terminal Air-conditioners/Heat Pumps, as defined in AHRI Standard 310/380 · CSA C744.

2.2.3 Room air-conditioners/heat pumps.

2.2.4 Unitary Air-conditioners and Unitary Air-source Heat Pumps as defined in AHRI Standard 340/360 with capacities of 65,000 Btu/h or greater.

2.2.5 Water-source Heat Pumps, Ground Water-source Heat Pumps, or ground-source closed-loop Heat Pumps as defined in ISO/ANSI/ASHRAE/AHRI Standards 13256-1 and 13256-2.

2.2.6 Water heating heat pumps.

2.2.7 Units equipped with desuperheater/water heating devices in operation.

2.2.8 Variable Refrigerant Flow Air Conditioners and Heat Pumps as defined in AHRI Standard 1230 with capacities of 65,000 Btu/h and greater.

2.2.9 Single Packaged Vertical Units as defined in ANSI/AHRI Standard 390.

Section 3. Definitions and Acronyms

All terms in this document will follow the standard industry definitions in the *ASHRAE Terminology* website (<https://www.ashrae.org/resources--publications/free-resources/ashrae-terminology>) unless otherwise defined in this section. Further definitions are found in Appendices C, D and E. For reference purposes, the user of this standard is informed there are also pertinent definitions in Title 10, *Code of Federal Regulations*, Part 430, Subpart 430.2. Throughout the standard defined terms are capitalized.

3.1 *Definitions.*

3.1.1 *Air-cooled Air-conditioner.* An air-conditioner which uses air as the medium to absorb heat in order to condense refrigerant.

3.1.2 *Airflow-control Setting(s).* Programmed or wired control system configurations that control a fan to achieve discrete, differing ranges of airflow—often designated for performing a specific function (e.g., cooling, heating, or constant circulation)—without manual adjustment other than interaction with a user-operable control (i.e., a thermostat) that meets the manufacturer specifications for installed-use. For the purposes of this standard, manufacturer specifications for installed-use are those found in the product literature shipped with the unit.

3.1.3 *Airflow Prevention Device.* A device that prevents airflow via natural convection by mechanical means, such as an air damper box, or by means of changes in duct height, such as an upturned duct.

3.1.4 *Air Moving System (AMS).*

3.1.4.1 *Constant-volume AMS.* A fan system that varies its operating speed to provide a fixed air-volume-rate from a Ducted System.

3.1.4.2 *Constant-torque AMS.* A fan system that maintains constant motor shaft torque over a broad range of loads.

3.1.4.3 *Permanent Split Capacitor (PSC) AMS.* A fan system connected to an induction motor that develops motor shaft torque proportional to the RPM slip from synchronous speed.

3.1.5 *Approach Temperature.* The refrigerant temperature at the outdoor liquid service port minus the outdoor ambient temperature.

3.1.6 *Blower Coil System.* A Split System that includes one or more Blower Coil Indoor Units.

3.1.7 *Coefficient of Performance (COP).* A ratio of the cooling/heating capacity in watts to the power input values in watts at any given set of Rating Conditions expressed in watt/watt (a dimensionless quantity). For heating COP, supplementary resistance heat shall be excluded.

3.1.8 *Coil-only System (Coil-only Air-conditioner or Coil-only Heat Pump).* A system that includes only (one or more) coil only Indoor Units.

3.1.9 *Crankcase Heater.* Any electrically powered device or mechanism for intentionally generating heat within and/or around the compressor sump volume. Crankcase Heater control may be achieved using a timer or may be based on a change in temperature or some other measurable parameter, such that the Crankcase Heater is not required to operate continuously. A Crankcase Heater without controls operates continuously when the compressor is not operating.

3.1.10 *Cyclic Test.* A test where the unit's compressor is cycled on and off for specific time intervals. A Cyclic Test provides half the information needed to calculate a Degradation Coefficient.

3.1.11 *Defrost Control System.*

3.1.11.1 *Demand-defrost Control System.* A system that defrosts the heat pump Outdoor Coil when measuring a predetermined degradation of performance. The heat pump's controls monitor one or more parameters that always vary with the amount of frost accumulated on the Outdoor Coil (e.g., coil to air differential temperature, coil differential air pressure, outdoor fan power or current, optical sensors, etc.) at least once for every ten minutes of compressor ON-time when space heating. One acceptable alternative to the criterion given in the prior sentence is a feedback system that measures the length of the defrost period and adjusts defrost frequency accordingly. In all cases, when the frost parameter(s) reaches a predetermined value, the system initiates a defrost. In a Demand-defrost Control System, defrosts are terminated based on monitoring a parameter(s) that indicates that frost has been eliminated from the coil.

Note: Systems that vary defrost intervals according to outdoor dry-bulb temperature are not demand defrost systems.

A Demand-defrost Control System, which otherwise meets the above requirements, shall allow time-initiated defrosts if, and only if, such defrosts occur after 6 hours of compressor operating time.

3.1.11.2 Time Adaptive Defrost Control System. A Demand-defrost Control System that measures the length of the prior defrost period(s) and uses that information to automatically determine when to initiate the next defrost cycle.

3.1.11.3 Time-temperature Defrost Control System. A control system that initiates or evaluates initiating a defrost cycle only when a predetermined cumulative compressor ON-time is obtained. This predetermined ON-time is generally a fixed value (e.g., 30, 45, 90 minutes) although it may vary based on the measured outdoor dry-bulb temperature. The ON-time counter accumulates if controller measurements (e.g., outdoor temperature, evaporator temperature) indicate that frost formation conditions are present, and it is reset/remains at zero at all other times. In one application of the control scheme, a defrost is initiated whenever the counter time equals the predetermined ON-time. The counter is reset when the defrost cycle is completed.

In a second application of the control scheme, one or more parameters are measured (e.g., air and/or refrigerant temperatures) at the predetermined, cumulative, compressor ON-time. A defrost is initiated only if the measured parameter(s) falls within a predetermined range. The ON-time counter is reset regardless of whether a defrost is initiated. If systems of this second type use cumulative ON-time intervals of 10 minutes or less, then the heat pump may qualify as having a Demand-defrost Control System.

3.1.12 Degradation Coefficient (C_D). A parameter used in calculating the Part Load Factor, which is a measure of the efficiency loss due to the cycling of the units. The Degradation Coefficient for cooling is denoted by C_D^c . The Degradation Coefficient for heating is denoted by C_D^h .

3.1.13 Design Heating Requirement (DHR). The amount of heating required to maintain a given indoor temperature at a particular outdoor design temperature. DHR predicts the space heating load of a structure when subjected to outdoor design conditions.

3.1.14 Double-duct System. Double-duct Air-conditioner or Heat Pump means air-cooled commercial package air-conditioning and heating equipment that is either a horizontal Single Package Unit or Split System; or a vertical unit that consists of two components that shall be shipped or installed either connected or split; is intended for indoor installation with ducting of outdoor air from the building exterior to and from the unit, where the unit and/or all of its components are non-weatherized and are not marked (or listed) as being in compliance with UL 1995/CSA C22.2 No.236 or equivalent requirements for outdoor use; if it is a horizontal unit, the complete unit shall have a maximum height of 35 in or the unit shall have components that do not exceed a maximum height of 35 in; if it is a vertical unit, the complete (split, connected, or assembled) unit shall have components that do not exceed maximum depth of 35 in; and, a rated cooling capacity less than 65,000 Btu/h.

3.1.15 Ducted System. An air-conditioner or heat pump that is designed to be permanently installed and delivers all conditioned air through ductwork. The air-conditioner or heat pump may be either a Split System unit or a Single Package Unit.

3.1.16 Energy Efficiency Ratio (EER). A ratio of the cooling capacity in Btu/h to the Total Power in watts at any given set of Rating Conditions expressed in Btu/(W·h).

3.1.16.1 $EER_{A,Full}$. The EER at A_{Full} test conditions.

3.1.16.2 Integrated Energy Efficiency Ratio (IEER). A single number cooling part load efficiency figure of merit calculated per the method described in Section 6.2.2 expressed in Btu/(W·h).

3.1.17 Evaporatively-cooled Air-conditioner. An air-conditioner which uses an external water source to enhance heat rejection from the condenser coil.

3.1.18 Gross Capacity. The calculated system capacity that results when not accounting for the heat generated from an indoor supply fan.

3.1.19 Heat Comfort Controller. A heat pump control that regulates the operation of the electric resistance elements to assure that the air temperature leaving the indoor section does not fall below a specified temperature even if the heat pump capacity exceeds the building load. This specified temperature is usually field adjustable and the temperature

shall be specified by the manufacturer as part of the equipment rating. Heat pumps that actively regulate the rate of electric resistance heating when operating below the balance point (as the result of a second stage call from the thermostat) but do not operate to maintain a minimum delivery temperature are not considered as having a heat controller.

3.1.20 Heating Season. The months of the year that require heating, e.g., typically, and roughly, October through April.

3.1.21 Heating Seasonal Performance Factor (HSPF). The total space heating required during the space heating season, Btu, divided by the total electrical energy, W·h, consumed by the heat pump system during the same season, Btu/(W·h). HSPF will vary depending on the region and Design Heating Requirement (refer to Section 11).

3.1.22 Independent Coil Manufacturer (ICM). A company that manufactures Indoor Units but does not manufacture Single Package Units or Outdoor Units.

3.1.23 Indoor Unit. A separate assembly of a Split System that includes both an arrangement of refrigerant-to-air heat transfer coil(s) for transfer of heat between the refrigerant and the indoor air and a condensate drain pan. An Indoor Unit may or may not include sheet metal or plastic parts not part of external cabinetry to direct/route airflow over the coil(s), a cooling mode expansion device, external cabinetry, air temperature sensing device and an integrated indoor blower (i.e. a device to move air including its associated motor). A separate designated air mover that may be a furnace or a Modular Blower may be considered to be part of the Indoor Unit. A Service Coil is not an Indoor Unit.

3.1.23.1 Blower Coil Indoor Unit. An Indoor Unit with either a) an indoor blower housed with the coil or b) a separate designated air mover such as a furnace or Modular Blower.

3.1.23.2 Air Handler. An arrangement of refrigerant-to-air heat transfer coil(s), condensate drain pan, sheet metal or plastic parts to direct/route airflow over the coil(s), air moving device, and external cabinetry. An Air Handler may or may not include a cooling mode expansion device and/or supplemental resistive heating elements.

3.1.23.2.1 Modular Blower. A product which only uses single-phase electric current, and which:

3.1.23.2.1.1 Is designed to be the principal air circulation source for the living space of a residence;

3.1.23.2.1.2 Is not contained within the same cabinet as a furnace or central air-conditioner; and

3.1.23.2.1.3 Is designed to be paired with HVAC products that have a heat input rate of less than 225,000 Btu per hour and cooling capacity less than 65,000 Btu per hour.

3.1.23.3 Coil-only Indoor Unit. An Indoor Unit that is distributed in commerce without an indoor blower or separate designated air mover. A Coil-only Indoor Unit installed in the field relies on a separately-installed furnace or a Modular Blower for indoor air movement.

3.1.23.3.1 Cased Coil. A Coil-only Indoor Unit with external cabinetry.

3.1.23.3.2 Uncased Coil. A Coil-only Indoor Unit without external cabinetry.

3.1.23.4 Service Coil. An arrangement of refrigerant-to-air heat transfer coil(s), condensate drain pan, sheet metal or plastic parts to direct/route airflow over the coil(s), sold specifically for the intent of replacing an Uncased Coil or Cased Coil that has already been placed into service and that has been labeled “for indoor coil replacement only” on the nameplate and in manufacturer technical and product literature. The model number for any Service Coil shall include some mechanism (e.g., an additional letter or number) for differentiating a Service Coil from a coil intended for an Indoor Unit. A Service Coil may or may not include external cabinetry and/or a cooling mode expansion device.

3.1.24 Installation Instructions. Manufacturer’s documentation that come packaged with or appear in the labels applied to the unit. This does not include online manual.

3.1.25 Latent Cooling Capacity. The rate, expressed in Btu/h, at which the equipment removes latent heat (reduces the moisture content) of the air passing through it under specified conditions of operation.

3.1.26 *Multiple-circuit (or Multi-circuit) System.* A Split System that has one Outdoor Unit and that has two or more Indoor Units installed on two or more refrigeration circuits such that each refrigeration circuit serves a compressor and one and only one Indoor Unit, and refrigerant is not shared from circuit to circuit.

3.1.27 *Multiple Capacity (Multiple Stage) Compressor.* A compressor having three or more pre-determined discrete stages of capacity that has neither an inverter nor variable frequency drive or a group of compressors with three or more stages of capacity.

3.1.27.1 *Full Compressor Stage (Full).* The staging of compressor(s) as specified by the manufacturer at which the unit operates at full load test conditions. The Full Compressor Stage for heating mode tests may be the same or different from the cooling mode value.

3.1.27.2 *Intermediate Compressor Stage (Int).*

3.1.27.2.1 *For Multi-split Systems.* The staging of compressor(s) as specified by the manufacturer that falls within one-fourth and three-fourths of the difference between the Low Compressor Stage and Full Compressor Stage for both cooling and heating, separately.

3.1.27.2.2 *For All Other Multiple Stage Compressors.* The stage within a 5% tolerance of the Low Compressor Stage plus one-third of the difference between Low Compressor Stage and Full Compressor or the next higher stage.

3.1.27.3 *Low Compressor Stage (Low).* The staging of compressor(s) as specified by the manufacturer at which the unit operates at low load test conditions. The Low Compressor Stage for heating mode tests may be the same or different from the cooling mode value.

3.1.27.4 *Nominal Compressor Stage (Nom).* A heating mode compressor stage equal to or higher than Full Compressor Stage in cooling.

3.1.28 *Net Capacity.* The calculated system capacity that results when accounting for the heat generated from an indoor supply fan.

3.1.29 *Nominal Capacity.* The capacity that is claimed by the manufacturer on the product name plate.

3.1.29.1 *Nominal Cooling Capacity.* A capacity approximately equal to the air conditioner cooling capacity tested at A or A2 condition.

As used in the definition for “Tested Combination” in 10 CFR, part 430, subpart B, appendix M, (a) for Indoor Units, the highest cooling capacity listed in published product literature for 95°F outdoor dry bulb temperature and 80°F dry bulb, 67°F wet bulb indoor conditions, and (b) for Outdoor Units, the lowest cooling capacity listed in published product literature for these conditions. If incomplete or no operating conditions are published, the highest (for Indoor Units) or lowest (for Outdoor Units) such cooling capacity available for sale shall be used.

3.1.29.2 *Nominal Heating Capacity.* A capacity approximately equal to the heat pump heating capacity tested in H1_{Nom} test or the optional H1_{Full} test.

3.1.30 *Non-ducted Indoor Unit.* An Indoor Unit designed to be permanently installed, mounted to/in ceilings and/or room walls, and/or to floors, and that directly heats or cools air within the conditioned space.

3.1.31 *Non-ducted System.* A Split System with one or more Non-ducted Indoor Units. The system components may be of a modular design.

3.1.32 *Non-tested Combination (NTC).* Any manufacturer approved combination of an Outdoor Unit(s) with one or more Indoor Units whose Certified Ratings are based on an AEDM.

3.1.33 *Normalized Gross Indoor Fin Surface (NGIFS).* The gross fin surface area of the indoor unit coil divided by the cooling capacity measured for the A or A2 Test, whichever applies.

- 3.1.34** *Off-mode Power Consumption.* The power consumption when the unit is connected to its main power source but is neither providing cooling nor heating to the building it serves.
- 3.1.35** *Off-mode Season.* For central air-conditioners other than heat pumps, the Shoulder Season and the entire Heating Season; and for heat pumps, the Shoulder Season only.
- 3.1.36** *Oil Recovery Mode.* An automatic system operation that returns oil to the compressor crank case when the control system determines that the oil level in the Outdoor Unit is low.
- 3.1.37** *Outdoor Coil.* A heat exchange surface that transfers heat between outdoor air and the refrigerant. The Outdoor Coil may be located internal or external to the building.
- 3.1.38** *Outdoor Unit.* A separate assembly of a Split System that transfers heat between the refrigerant and the outdoor air, and consists of an Outdoor Coil, compressor(s), an air moving device, and in addition for heat pumps, may include a heating mode expansion device, reversing valve, and/or defrost controls.
- 3.1.39** *Outdoor Unit Manufacturer (OUM).* A manufacturer of Single Package units, Outdoor Units, and/or both Indoor Units and Outdoor Units.
- 3.1.40** *Part Load Factor (PLF).* The ratio of the cyclic EER (or COP for heating) to the steady-state EER (or COP), where both EERs (or COPs) are determined based on operation at the same ambient conditions.
- 3.1.41** *Published Rating.* A statement of the assigned values of those performance characteristics, under stated Rating Conditions, by which a unit may be chosen to fit its application. These values apply to all units of like Nominal Capacity and type (identification) produced by the same manufacturer. As used herein, the term Published Rating includes the rating of all performance characteristics shown on the unit or published in specifications, advertising, or other literature controlled by the manufacturer, at stated Rating Conditions.
- 3.1.41.1** *Application Rating.* A rating based on tests performed at Application Rating Conditions (other than Standard Rating Conditions).
- 3.1.41.2** *Certified Rating(s).* A Published Rating of certified data as defined by Section 3.9 of the AHRI Unitary Small Equipment Operations Manual which is verified by audit testing.
- 3.1.41.3** *Standard Rating.* A rating based on tests performed at Standard Rating Conditions.
- 3.1.42** *Rating Conditions.* Any set of operating conditions under which a single level of performance results and which causes only that level of performance to occur.
- 3.1.42.1** *Standard Rating Conditions.* Rating Conditions used as the basis of comparison for performance characteristics.
- 3.1.43** *Seasonal Energy Efficiency Ratio (SEER).* The total heat removed from the conditioned space during the annual cooling season, Btu, divided by the total electrical energy, W·h, consumed by the air-conditioner or heat pump during the same season, Btu/(W·h).
- 3.1.44** *Sensible Cooling Capacity.* The rate, expressed in Btu/h, at which the equipment lowers the dry-bulb temperature (removes sensible heat) of the air passing through it under specified conditions of operation.
- 3.1.45** *"Shall" or "Should".* "Shall" or "should" shall be interpreted as follows:
- 3.1.45.1** *Shall.* Where "shall" or "shall not" is used for a provision specified, that provision is mandatory if compliance with the standard is claimed.
- 3.1.45.2** *Should.* "Should" is used to indicate provisions which are not mandatory but which are desirable as good practice.
- 3.1.46** *Shoulder Season.* The months of the year in between those months that require cooling and those months that require heating, e.g., typically, and roughly, April through May, and September through October.

3.1.47 *Single Package Unit (Single Package Air-conditioner or Single Package Heat Pump).* Any central air-conditioner or heat pump that has all major assemblies enclosed in one cabinet.

3.1.48 *Single Stage System (Single Stage Air-conditioner or Single Stage Heat Pump).* An air-conditioner or heat pump that has a single, fixed capacity compressor.

3.1.49 *Small-duct, High-velocity System.* A Split System for which all Indoor Units are Blower Coil Indoor Units that produce at least 1.2 in (of water column) of external static pressure when operated at the full-load air volume rate certified by the manufacturer of at least 220 scfm per rated ton of cooling.

3.1.50 *Space Constrained Product.* A central air-conditioner or heat pump:

3.1.50.1 that has rated cooling capacities no greater than 30,000 Btu/h;

3.1.50.2 that has an outdoor or Indoor Unit having at least two overall exterior dimensions or an overall displacement that:

3.1.50.2.1 is substantially smaller than those of other units that are:

3.1.50.2.1.1 currently usually installed in site built single family homes; and

3.1.50.2.1.2 of a similar cooling, and, if a heat pump, heating capacity; and

3.1.50.2.2 if increased, would certainly result in a considerable increase in the usual cost of installation or would certainly result in a significant loss in the utility of the product to the consumer; and

3.1.50.3 of a product type that was available for purchase in the United States as of December 1, 2000.

3.1.51 *Split System (Split System Air-conditioner or Split System Heat Pump).* Any air-conditioner or heat pump that has at least two separate assemblies that are connected with refrigerant piping when installed. At least one of these assemblies is an Indoor Unit and at least one of these assemblies is an Outdoor Unit. Split Systems may be either Blower Coil System or Coil-only Systems.

3.1.51.1 *Multi-head Mini-split System.* A Split System that has one Outdoor Unit and that has two or more Indoor Units connected with a single refrigeration circuit. The Indoor Units operate in unison in response to a single indoor thermostat.

3.1.51.2 *Multi-split System (Multi-split Air-conditioner or Multi-split Heat Pump).* A Split System that has one Outdoor Unit and having two or more Indoor Units connected with a single refrigeration circuit. The Indoor Units operate independently and can be used to condition multiple zones in response to at least two indoor thermostats or temperature sensors. The Outdoor Unit operates in response to independent operation of the Indoor Units based on control input of at least two indoor thermostats or temperature sensors, and/or based on refrigeration circuit sensor input.

3.1.51.3 *Single-split System (Single-split Air-conditioner or Single-split Heat Pump).* A Split System that has one Outdoor Unit and one Indoor Unit connected with a single refrigeration circuit.

3.1.52 *Standard Air.* Dry air having a mass density of 0.075 lb/ft³.

3.1.53 *Steady-state Test.* A test where the controlled test parameters are regulated to remain constant within the specified tolerances while the unit operates continuously in the same mode.

3.1.54 *System Controls.* These devices may include but are not limited to:

3.1.54.1 An integral network operations and communications system with sensors to monitor the status of items such as temperature, pressure, oil, refrigerant levels and fan speed.

3.1.54.2 A micro-processor, algorithm-based control scheme to: (1) communicate with a managed variable capacity compressor, fan speed of Indoor Units, fan speed of the Outdoor Unit, solenoids, various accessories;

(2) manage metering devices; and (3) concurrently operate various parts of the system.

3.1.54.3 Regulation of system efficiency and refrigerant flow through an engineered distributed refrigerant system to conduct zoning operations, matching capacity to the load in each of the zones.

3.1.55 *Temperature Bin.* The 5 °F increments used to partition the outdoor dry-bulb temperature ranges of the cooling (≥ 65 °F) and heating (< 65 °F) seasons.

3.1.56 *Test Condition Tolerance.* The maximum permissible difference between the average value of the measured test parameter and the specified test condition.

3.1.57 *Test Operating Tolerance.* The maximum permissible range a measurement may vary over the specified test interval. When expressed as a percentage, the maximum allowable variation is the specified percentage of the average value. The difference between the maximum and minimum sampled values shall be less than or equal to the specified Test Operating Tolerance.

3.1.58 *Tested Combination.* A specific combination of an Outdoor Unit(s) with one or more Indoor Units having measured performance in a laboratory psychrometric facility.

3.1.58.1 *Single-split Tested Combination.* A specific combination of an Outdoor Unit with either one Indoor Unit or multiple Indoor Units which operate in unison. See Section 6.5.3.

3.1.58.2 *Multi-split Tested Combination.* A specific combination of an Outdoor Unit with between two and five Indoor Units. See Section 6.5.3.

3.1.59 *Total Cooling Capacity.* The sum of Sensible and Latent Capacity the equipment can remove from the conditioned space in a defined interval of time in Btu/h (Net Capacity in the cooling mode).

3.1.60 *Total Heating Capacity.* The amount of Sensible Capacity the equipment can add to the conditioned space in a defined interval of time in Btu/h (Net Capacity in the heating mode).

3.1.61 *Total Power.* The sum of the power consumed by all components of a system, including the power consumed by the compressor(s), indoor supply fan motor(s), outdoor condenser fan motor(s), System Controls, factory installed condensate pumps and other devices required for normal operating modes.

3.1.62 *Triple-capacity, Northern Heat Pump.* a heat pump that provides two stages of cooling and three stages of heating. The two common stages for both the cooling and heating modes are the low capacity stage and the high capacity stage. The additional heating mode stage is the booster capacity stage, which offers the highest heating capacity output for a given set of ambient operating conditions.

3.1.63 *Two-capacity (or Two-stage) Compressor.* A compressor or group of compressors operating with only two stages of capacity.

3.1.63.1 *Full Compressor Stage (Full).* The staging of compressor(s) as specified by the manufacturer at which the unit operates at full load test conditions.

3.1.63.2 *Low Compressor Stage (Low).* The staging of compressor(s) as specified by the manufacturer at which the unit operates at low load test conditions. The Low Compressor Stage for heating mode tests may be the same or different from the cooling mode value.

3.1.64 *Two-capacity Northern Heat Pump.* A heat pump that has a factory or field-selectable lock-out feature to prevent space cooling at high-capacity. Two-capacity heat pumps having this feature will typically have two sets of ratings, one with the feature disabled and one with the feature enabled. The heat pump is a Two-capacity Northern Heat Pump only when this feature is enabled at all times. The certified indoor coil model number shall reflect whether the ratings pertain to the lockout enabled option via the inclusion of an extra identifier, such as "+LO". When testing as a Two-capacity, Northern Heat Pump, the lockout feature shall remain enabled for all tests.

3.1.65 *Two-capacity (or Two-stage) System (Two-stage Air-conditioner or Two-stage Heat Pump).* An air - conditioner(s) or heat pump(s) that use a Two-capacity Compressor or two single stage Outdoor Units connected to a single Indoor Unit, where each Outdoor Unit can operate independently or jointly.

3.1.66 *Unitary Air-conditioner (Air-conditioner)*. One or more factory-made assemblies which normally include an indoor coil(s), compressor(s), Outdoor Coil(s), indoor fan(s), outdoor fan(s), and expansion device(s). When such equipment is provided in more than one assembly, the separated assemblies shall be designed to be used together, and the requirements of rating outlined in the standard are based upon the use of matched assemblies.

3.1.66.1 *Functions*. Air-conditioners shall provide the function of air-circulation, air cleaning, cooling with controlled temperature and dehumidification, and may optionally include the function of heating and/or humidifying.

3.1.67 *Unitary Air-source Heat Pump (Heat Pump)*. One or more factory-made assemblies which normally include an indoor coil(s), compressor(s), Outdoor Coil(s), indoor fan(s), outdoor fan(s), and expansion device(s) including means to provide a heating function. When such equipment is provided in more than one assembly, the separated assemblies shall be designed to be used together, and the requirements of rating outlined in the standard are based upon the use of matched assemblies.

3.1.67.1 *Functions*. Heat Pumps shall provide the function of air heating with controlled temperature, and may include the functions of air-cooling, air-circulating, air-cleaning, dehumidifying or humidifying.

3.1.67.2 *Heat pump having a Heat Comfort Controller*. A heat pump with controls that can regulate the operation of the electric resistance elements to assure that the air temperature leaving the indoor section does not fall below a specified temperature. Heat pumps that actively regulate the rate of electric resistance heating when operating below the balance point (as the result of a second stage call from the thermostat) but do not operate to maintain a minimum delivery temperature are not considered as having a Heat Comfort Controller.

3.1.68 *Variable Capacity (or Variable Stage or Variable Speed) System (Variable Stage Air-conditioner or Variable Stage Heat Pump)*. Air-conditioner(s) or heat pump(s) that has either a Variable Speed Compressor or a Multiple Capacity Compressor.

3.1.69 *Variable Refrigerant Flow (VRF) System*. A Multi-split System with at least three compressor capacity stages, distributing refrigerant through a piping network to multiple indoor blower coil units each capable of individual zone temperature control, through proprietary zone temperature control devices and a common communications network.

Note: Single-phase VRF systems less than 65,000 Btu/h are central air-conditioners and central air conditioning heat pumps, also referred to as Unitary Air-conditioners and Unitary Air-source Heat Pumps.

3.1.70 *Variable Speed Compressor*. A compressor that has capability of varying its rotational speed in non-discrete stages or steps from low to full using an inverter or variable frequency drive.

3.1.70.1 *Boost Compressor Speed (Boost)*. A speed faster than Full Compressor Speed, as specified by the manufacturer, at which the unit will operate to achieve increased capacity. The Boost Compressor Speed for heating mode tests may be the same or different from the cooling mode value.

3.1.70.2 *Full Compressor Speed (Full)*. The speed as specified by the manufacturer at which the unit operates at full load test conditions. The Full Compressor Speed for heating mode tests may be the same or different from the cooling mode value.

3.1.70.3 *Intermediate Compressor Speed (Int)*.

3.1.70.3.1 *For Multi-split Systems*. The speed as specified by the manufacturer that falls within one-fourth and three-fourths of the difference between the Low Compressor Speed and Full Compressor Speed for both cooling and heating, separately.

3.1.70.3.2 *For All Other Variable Stage Systems*. Low Compressor Speed plus one-third of the difference between Low Compressor Speed and Full Compressor Speed with a tolerance of plus 5% or the next higher inverter frequency step.

3.1.70.4 *Low Compressor Speed (Low)*. The speed as specified by the manufacturer at which the unit operates at low load test conditions. The Low Compressor Speed for heating mode tests may be the same or different from the cooling mode value.

3.1.70.5 *Nominal Compressor Speed (Nom)*. A heating mode compressor speed equivalent to no lower than Full Compressor Speed in cooling, under the condition that H12 rated capacity is less than A2 rated Cooling Capacity.

Note: Nominal Compressor Speed is not directly connected to Nominal Capacity.

3.1.71 *Water-cooled Air-conditioner*. An air-conditioner which uses water as the medium to absorb heat in order to condense refrigerant.

3.1.72 *Wet-coil Test*. A test conducted at test conditions that typically cause water vapor to condense on the test unit evaporator coil.

3.2 *Acronyms.*

3.2.1 *AEDM*. Alternative Efficiency Determination Method.

3.2.2 *AHRI*. Air-Conditioning, Heating, and Refrigeration Institute.

3.2.3 *ASHRAE*. American Society of Heating, Refrigerating and Air-Conditioning Engineers.

3.2.4 *CFR*. Code of Federal Regulations.

Section 4. Classifications

4.1 *Classifications*. Equipment covered within the scope of this standard shall be classified as shown in Tables 1, 2 and 3.

Table 1. Classification of Unitary Air-conditioners

Designation	AHRI Type ^{1,2}	Arrangement - ID	Arrangement - OD
Single Package Unit	SP-A ⁷ SP-E ⁷ SP-W ^{7,8}		ELEC HEAT ³ OD FAN or PUMP
			ID FAN COMP
			EVAP COND
Year-Round Single Package Unit	SPY-A ^{5,7} SPY-E ^{5,7} SPY-W ^{5,7,8}		GAS HEAT ⁴ OD FAN or PUMP
			ID FAN COMP
			EVAP COND
Remote Condenser	RC-A RC-E RC-W ⁸	ID FAN	OD FAN or PUMP COND
		EVAP	
		COMP	
Split System Air-conditioner with Coil-only	RCU-A-C RCU-E-C RCU-W-C ⁸	EVAP	OD FAN or PUMP COMP COND
Split System Air-conditioner with Coil Blower	RCU-A-CB ^{6,7} RCU-E-CB ⁶ RCU-W-CB ^{6,8}	ID FAN	OD FAN or PUMP COMP COND
		EVAP	
Year-Round Split System Air-conditioner with Coil Blower	RCUY-A-CB ^{5,6,7} RCUY-E-CB ^{5,6,7} RCUY-W-CB ^{5,6,7,8}	GAS HEAT ⁴	OD FAN or PUMP COMP COND
		ID FAN	
		EVAP	

Notes:

1. A suffix of "-O" following any of the above classifications indicates a Non-ducted System.
2. "-A" indicates air-cooled condenser, "-E" indicates evaporatively cooled condenser and "-W" indicates water-cooled condenser.
3. Optional component.
4. May also be other heat source except for electric strip heat.
5. For Space Constrained Products, insert "SCP-" at the beginning.
6. For Small-duct, High-velocity System, insert "SDHV-" at the beginning.
7. For Double-duct System, append "-DD", and outdoor arrangement moves from outdoor side to indoor side.
8. For water-cooled products, outdoor arrangement moves from outdoor side to indoor side.

Table 2. Classification of Unitary Air-source Heat Pumps			
Designation	AHRI Type ^{1,2}	Arrangement - ID	Arrangement - OD
Single Package Unit	HSP-A ^{5,7}		ELEC HEAT ³ OD FAN or PUMP
			ID FAN COMP
			EVAP COND
Year-Round Single Package Unit	HSPY-A ^{5,7}		GAS HEAT ⁴ OD FAN or PUMP
			ID FAN COMP
			EVAP COND
Remote Outdoor Coil	HRC-A-CB ^{2,7}	ID FAN	OD FAN or PUMP
		EVAP	
		COMP	
Remote Outdoor Coil, Coil-only	HRC-A-C ^{2,7}	EVAP	OD FAN or PUMP
		COMP	
		COND	
Year Round Split System Heat Pump with Coil Blower	HRCUY-A-CB	ELEC HEAT ⁴	OD FAN or PUMP
		ID FAN	
		EVAP	
Split System Heat Pump with Coil Blower	HRCU-A-CB ^{6,7}	ELEC HEAT ³	OD FAN or PUMP
		ID FAN	
		EVAP	
Split System Heat Pump with Coil-only	HRCU-A-C ^{6,7}	EVAP	OD FAN or PUMP
		COMP	
		COND	

Notes:

1. A suffix of "-O" following any of the above classifications indicates a Non-ducted System.
2. For Heating Only, change the initial "H" to "HO"
3. Optional component
4. May also be other heat source except for electric strip heat.
5. For Space Constrained Products, insert "SCP-" at the beginning.
6. For Small-duct, High-velocity System, insert "SDHV-" at the beginning.
7. For Double-duct System, append "-DD", and outdoor arrangement moves from outdoor side to indoor side.

Table 3. Classification of Multi-split Systems

System Identification		Multi-split	Heat Recovery Multi-split
Attribute			
Refrigerant Circuits		One shared to all Indoor Units	One shared to all Indoor Units
Compressors		One or more variable speed or alternative method resulting in three or more steps of capacity	One or more variable speed or alternative method resulting in three or more steps of capacity
Indoor Units	Quantity	Greater than one Indoor Unit	Greater than one Indoor Unit
	Operation	Individual Zones/Temperature	Individual Zones/Temperature
Outdoor Unit/s	Quantity	One Outdoor Unit or multiple manifolded Outdoor Units with a specific model number.	One Outdoor Unit or multiple manifolded Outdoor Units with a specific model number.
	Steps of Control	Three or More	Three or More
	Mode of Operation	Cooling, Heating	Cooling, Heating, Heat Recovery
	Heat Exchanger	One or more circuits of shared refrigerant flow	One or more circuits of shared refrigerant flow
Classification ^{1, 2}	Air-conditioner (air-to-air)	MSV-A-CB	
	Heat Pump (air-to-air)	HMSV-A-CB	HMSR-A-CB
Notes:			
1. A suffix of "-O" following any of the above classifications indicates a Non-ducted System.			
2. "-A" indicates air-cooled condenser, and may be substituted with "-E" to indicate an evaporatively cooled condenser, or "-W" to indicate a water-cooled condenser.			

Section 5. Test Requirements

5.1 All testing for Standard Ratings shall be conducted in accordance with the test methods and procedures as described in this standard and its appendices.

5.1.1 Air-cooled units shall be tested in accordance with ANSI/ASHRAE Standard 37 as amended by Appendix D and Appendix E and ANSI/ASHRAE Standard 116 as amended by Appendix F. Water-cooled and Evaporatively-cooled Air-conditioner shall be tested in accordance with ANSI/ASHRAE Standard 37 as amended by Appendix E. In ANSI/ASHRAE Standards 37 and 116, wherever terms “may” or “should” are used, they shall be taken to be mandatory requirements.

5.1.1.1 Units shall be installed per Installation Instructions. For ICM Split Systems follow the Installation Instructions provided with the Indoor Unit. For products in a certification program, additional information required for testing shall be submitted through the certification process.

5.1.2 *Variable Speed Equipment.* A means to override the controls of the Variable Speed System under test shall be provided by the manufacturer that claims the performance of the particular system, when needed, prior to initial set-up during laboratory testing.

5.1.2.1 The means for overriding the controls of the test unit shall necessitate ability to control the compressor, outdoor fan, indoor blower and expansion device(s) such that the compressor(s) operates at the specified speed or capacity, the outdoor fan operates per the manufacturer specification, the indoor blower operates at the specified speed or delivers the specified air volume rate, and the expansions device(s) operate per manufacturer specification.

5.1.2.2 Power used for any override controls that would not normally be installed in the field shall not be included in Total Power.

5.1.3 Break-in. If an initial break-in period is required to achieve performance, the break-in conditions and duration shall be specified by the manufacturer, but shall not exceed 20 hours in length. No testing per Section 6 shall commence until the specified break-in period is completed.

5.1.4 Test Unit Installation Requirements. For units designed for both horizontal and vertical installation or for both up-flow and down-flow vertical installations, the manufacturer shall specify the orientation used for testing. Conduct testing with the following installed:

5.1.4.1 Factory installed supplementary resistance heat; and

5.1.4.2 Other equipment specified as part of the unit, including all hardware used by a Heat Comfort Controller if so equipped. For Small-duct, High-velocity Systems, configure all balance dampers or restrictor devices on or inside the unit to fully open or lowest restriction.

5.1.5 Defrost controls shall be set for region IV (refer to Section 11.2.2), or left at manufacturer’s factory settings if the published Installation Instructions provided with the equipment do not specify a Region IV selection. For heat pumps that use a Time-temperature Defrost Control System, this may require changing the time setting. For heat pumps that use a Time Adaptive Defrost Control System, the manufacturer shall specify the frosting interval to be used during frost accumulation tests and provide the procedure for manually initiating the defrost at the specified time. The manufacturer shall provide information and any necessary hardware to manually initiate a defrost cycle.

5.1.6 Requirements for Separated Assemblies. All Standard Ratings for Split Systems shall be determined with at least 25 ft of interconnecting tubing on each line of the size recommended by the manufacturer. Equipment in which the interconnecting tubing is furnished as an integral part of the system not recommended for cutting to length shall be tested with the complete length of tubing furnished, or with 25 ft of tubing, whichever is greater. At least 10 ft of the interconnecting tubing shall be exposed to the outside conditions. The line sizes, insulation, and details of installation shall be in accordance with the manufacturer’s published recommendation.

5.1.6.1 When testing Multi-split Systems, connect each indoor fan-coil to the Outdoor Unit using: (a) 25 feet of tubing, or (b) tubing furnished by the manufacturer, whichever is longer, per Indoor Unit. If a branching device is used, the common piping between the Outdoor Unit and the branching device shall be included in the overall length between indoor and outdoor sections.

5.1.6.1.1 Multi-split Line Length Correction. For test setups where the laboratory’s physical limitations require use of more than the required line length, refer to Table 4 for Cooling Capacity correction factors that shall be used when the refrigerant line length exceeds the minimum as specified in Section 5.1.6.1. Cooling capacity correction factor, F_{CC} , is used in Section 11.1 to adjust cooling capacity.

Piping length beyond the requirement (X), ft	Cooling Capacity Correction Factor, F_{CC}
$3.3 < X \leq 20$	1.01
$20 < X \leq 40$	1.02
$40 < X \leq 60$	1.03
$60 < X \leq 80$	1.04
$80 < X \leq 100$	1.05
$100 < X \leq 120$	1.06
Note: 1. Due to the refrigerant line lengths required in the test setup as determined by laboratory personnel, a correction factor shall be applied to normalize the measured cooling capacity 2. The piping length X is the additional refrigerant piping length above the minimum described in Section 5.1.6.1 that has been applied to at least 33% (minimum of 2) of the Indoor Units in the testing configuration. 3. In all cases, the absolute minimum length necessary to physically connect the system shall	

Table 4. Refrigerant Line Length Correction Factors^{1, 2, 3} (Continued)

<p>be used.</p> <p>4. Average piping length in addition to the minimum in Table 4 (X), ft for at least 33% (minimum of 2) of the Indoor Units. (the length (X) is the differential distance between the actual piping length between the Outdoor Unit and the Indoor Unit and the minimum requirement).</p> <p>2. The piping length X is the cumulative additional line length above the minimum as specified in Section 5.1.6.1.</p> <p>3. If tubing is not provided by the manufacturer, the absolute minimum length necessary to physically connect the system shall be used</p>

5.1.6.2 *Outdoor Unit with No Match.* An Outdoor Unit intended for use with R22 or R22-like refrigerants shall be deemed an Outdoor Unit with No Match (OUWNM). An OUWNM shall be tested with an indoor coil having nominal tube diameter of 0.375 in and an NGIFS of 1.0 or less (as determined in Section 5.1.6.3). An R22-like refrigerant is any refrigerant that has a 95 °F midpoint saturation absolute pressure that is ± 18% of the 95°F midpoint saturation absolute pressure of R22.

5.1.6.2.1 *Dry-ship Units.* Any Outdoor Unit shipped without a specified refrigerant from the point of manufacture, or if the unit is shipped such that more than two pounds of refrigerant is required to be added for testing to this standard shall be tested as an OUWNM. This shall not apply if either a) the factory charge is equal to or greater than 70% of the Outdoor Unit internal volume times the liquid density of refrigerant at 95°F or b) an A2L refrigerant is approved for use.

5.1.6.3 *Indoor Coil NGIFS.* The Normalized Gross Indoor Fin Surface (NGIFS) shall be calculated as follows:

$$NGIFS = 2 \cdot L_f \cdot W_f \cdot N_f / \dot{q}_{A,Full} \quad 5.1$$

5.1.7 *Refrigerant Charging.* All test samples shall be charged at Standard Rating Conditions (or condition at which the manufacturer indicates in the Installation Instructions) in accordance with the Installation Instructions or labels applied to the unit. If the Installation Instructions give a specified range for superheat, sub-cooling, or refrigerant pressure, the average of the range shall be used to determine the refrigerant charge. Perform charging of near-azeotropic and zeotropic refrigerants only with refrigerant in the liquid state.

If there are no Installation Instructions and/or the Installation Instructions do not provide parameters and target values, set superheat to a target value of 12 °F for fixed orifice systems or set subcooling to a target value of 10 °F for expansion valve systems.

5.1.7.1 Except for mix-matched systems covered in Section 5.1.7.2 and Multi-split Systems, in the event of conflicting information between charging instructions, the Outdoor Unit label prevails, followed by Installation Instructions of the Outdoor Unit, followed by the Installation Instructions of the Indoor Unit. For Multi-split systems, the hierarchy is Outdoor Unit installation instructions prevail, followed by the Outdoor Unit label, followed by the Indoor Units' installation instructions. Conflicting information is defined as multiple conditions given for charge adjustment where all conditions specified cannot be met. In such instances of conflicting information, follow the hierarchy in Table 5 for priority. Unless the manufacturer specifies a different charging tolerance, the tolerances specified in Table 5 shall be used for all products.

The refrigerant charge obtained at the Standard Rating Condition shall then be used to conduct all cooling cycle and heating cycle tests unless an adjustment is required based on the sections below. Once the correct refrigerant charge is determined, all tests shall run until completion without further modification.

Informative Note: After completion of all required tests, it is good laboratory practice to achieve A_{Full} test conditions for 30 continuous minutes and compare results to the previous set of A_{Full} tests. When comparing results, measured charge parameters outside of those listed in Table 5 is an indication refrigerant charge or other parameters may have changed and analysis shall be performed and corrective actions shall be made.

Table 5. Test Condition Tolerance for Charging Hierarchy					
Fixed Orifice			Expansion Valve		
Priority	Method	Tolerance	Priority	Method	Tolerance
1	Super-heat	± 2.0 °F	1	Sub-cooling	10% of the Target Value; No less than ± 0.5 °F, No more than ± 2.0 °F
2	High Side Pressure or Saturation Temperature	± 4.0 psi or ± 1.0 °F	2	High Side Pressure or Saturation Temperature	± 4.0 psi or ± 1.0 °F
3	Low Side Pressure or Saturation Temperature	± 2.0 psi or ± 0.8 °F	3	Low Side Pressure or Saturation Temperature	± 2.0 psi or ± 0.8 °F
4	Low Side Temperature	± 2.0 °F	4	Approach Temperature	± 1.0 °F
5	High Side Temperature	± 2.0 °F	5	Charge Weight	0.5% or 1.0 oz, whichever is greater ± 2.0 oz
6	Charge Weight	± 2.0 oz			

5.1.7.2 *Mix-Matched Systems.* For systems consisting of an OUM Outdoor Unit and an ICM Indoor Unit with differing charging procedures the refrigerant charge shall be adjusted per the ICM Installation Instructions. If instructions are provided only with the Outdoor Unit or are provided only with an ICM Indoor Unit, then use the provided instructions.

5.1.7.3 *Heat Pumps.* Refrigerant charge shall be set at the A_{Full} conditions or as specified by the manufacturer. The initial heating test shall be H1_{Full} test, charge parameters shall be checked per the Installation Instructions (if provided). If conditions are within the range specified by Installation Instructions continue with the remainder of the tests.

5.1.7.3.1 If heating refrigerant charge parameters are not within the range specified by the Installation Instructions then the smallest adjustment to refrigerant charge to get within the heating refrigerant charge parameters shall be made. After making this adjustment in the H1_{Full} test, refrigerant charge shall be verified in the cooling mode to be within the greater of the installation instruction tolerances or the tolerances listed in the Table 5 above before re-running the cooling tests.

5.1.7.4 *Single Package Unit.* Unless otherwise directed by the Installation Instructions, install one or more refrigerant line pressure gauges during the setup of the unit, located depending on the parameters used to verify or set charge, as described in this section:

5.1.7.4.1 Install a pressure gauge at the location of the service valve on the liquid line if charging is on the basis of subcooling, or high side pressure or corresponding saturation or dew point temperature;

5.1.7.4.2 Install a pressure gauge at the location of the service valve on the suction line if charging is on the basis of superheat, or low side pressure or corresponding saturation or dew point temperature.

Use methods for installing pressure gauge(s) at the required location(s) as indicated in Installation Instructions if specified.

5.2 *Cyclic Test Requirements.*

5.2.1 Inlet plenum may include a damper section or Airflow Prevention Device.

5.2.1.1 When using an upturned duct Airflow Prevention Device, place a dry bulb temperature sensor near the inlet opening of the indoor duct at a centerline location not higher than the lowest elevation of the duct

edges at the inlet, and ensure that the variation of the dry bulb temperature at this location, measured at least every minute during the compressor OFF period of the Cyclic Test, does not exceed 1.0 °F.

5.2.1.2 The inlet and outlet damper leakage rate shall not exceed a combined 20 cfm when a negative pressure of 1.0 in H₂O is maintained at the plenum’s inlet.

5.2.1.3 The outlet plenum, minimum of 9 individual temperature sensors, shall not exceed a difference of 1.5 °F during the ON cycle. Use of mixers and/or perforated screen shall be used to meet this requirement.

5.2.2 *Electrical Voltage, Power and Energy Measurement.*

5.2.2.1 The supply voltage at the terminals on the test unit, using a voltage meter that provides a reading that is accurate to within ±1.0% of the measured quantity shall be used. During the ON and OFF cycle the voltage total observed range, excluding the 30 seconds after compressor startup and shutdown, shall not exceed 2.0% and the set-point average error shall not exceed 1.5%.

5.2.2.2 Watt hour measurement system shall be accurate within ±0.5% or 0.5 W/h, whichever is greater, for both ON and OFF cycles. If two measurement systems are used, then the meters shall be switched within 15 seconds of the start of the OFF cycle and switched within 15 seconds prior to the start of the ON cycle.

5.2.3 *Grid Differential Temperature.*

5.2.3.1 While conducting the steady state test associated with the Cyclic Test, observe the difference between the entering dry bulb and leaving dry bulb temperature using both the grid/thermopile and the primary psychrometer sensors. Sample values from all sensors one minute apart for 6 minutes, total of 7 readings. Determine the value of F_{CD} .

$$F_{CD} = \frac{1}{7} \sum_{i=6}^i \frac{\Delta T_{RTD}}{\Delta T_{TC}} \tag{5.2}$$

ΔT_{RTD} shall be the temperature differential between inlet air stream and outlet air stream as measured by RTDs, or equivalent, meeting the accuracy requirements for steady state testing. ΔT_{TC} shall be the temperature differential between inlet air stream and outlet air stream as measured by thermocouple grid, thermocouple thermopile, or equivalent, meeting the response requirements for cyclic testing.

5.2.3.2 If any F_{CD} calculated throughout the steady state test (total of 5 values) is outside the range of 0.94 to 1.06 then stop the test and recalibrate the temperature sensors.

5.2.3.3 The final value of the F_{CD} ratio shall be set to F_{CD}^* . Use F_{CD}^* as a correction factor applied to the grid or thermopile measurement during the Cyclic Test. If the temperature sensors used to provide the primary measurement of the indoor-side dry bulb temperature difference during the steady-state dry-coil test and the subsequent cyclic dry-coil test are the same, set $F_{CD}^* = 1$.

5.2.4 *Cycle Stability Requirements.* Conduct three complete compressor OFF/ON cycles with the test tolerances given in Table 11 satisfied. Calculate the degradation coefficient C_D for each complete cycle. If all three C_D values are within 0.02 of the average C_D then stability has been achieved, and the highest C_D value of these three shall be used. If stability has not been achieved, conduct additional cycles, up to a maximum of eight cycles total, until stability has been achieved between three consecutive cycles. Once stability has been achieved, use the highest C_D value of the three consecutive cycles that establish stability. If stability has not been achieved after eight cycles, use the highest C_D from cycle one through cycle eight, or the default C_D , whichever is lower.

5.3 For reference purposes only, Table 6 is provided summarizing the various sections of this standard that are applicable to different types of equipment.

5.4 *Oil Recovery.* The Oil Recovery Mode shall be activated during testing. If Oil Recovery prevents a Steady-state test use the transient test procedure as described in Section 8.8.3 (except Section 8.8.3.3) of ANSI/ASHRAE Standard 37, with the revisions in the following section:

5.4.1 For tests that cannot reach Steady-state because of Oil Recovery, Section 8.8.3 (except Section 8.8.3.3) of ANSI/ASHRAE Standard 37 shall be modified by replacing all mentions of “defrost” with “Oil Recovery”, replacing all mentions of “Heat Pump” with “system” and replacing all mentions of “heating” with “conditioning”. The test tolerances specified in Table 2 of ANSI/ASHRAE Standard 37 for “heat portion” under “heat with frost” shall be satisfied when conducting the tests. The test tolerance parameters included in Table 2 of ANSI/ASHRAE Standard 37 shall be sampled throughout the preconditioning and data collection period. For the purpose of evaluating compliance with the specified test tolerances, the dry bulb temperature of the air entering the indoor side and the outdoor side, and the water vapor content of the air entering the outdoor side shall be sampled at least every minute. All other parameters shall be sampled at equal intervals that span five minutes or less.

Section 6. Rating Requirements

6.1 *Standard Ratings.* Standard Ratings shall be established at the Standard Rating Conditions specified per Tables 7, 8, and 9. Standard Ratings shall be established for all refrigerants listed on the nameplate of product.

Standard Ratings relating to cooling or heating capacities shall be net values, including the effects of circulating-fan heat, but not including supplementary electric heat. Power input used for calculating efficiency shall be the Total Power. Supplementary electric heat is used in HSPF calculations as noted in Section 11.

Standard Ratings of units which do not have indoor air-circulating fans furnished as part of the model, i.e., Coil-only System, shall be established by subtracting from the total cooling capacity 1,250 Btu/h per 1,000 scfm, and by adding the same amount to the heating capacity. Total Power for both heating and cooling shall be increased by 365 W per 1,000 scfm of indoor air circulated.

Standard Ratings of water-cooled units shall include a total allowance for cooling tower fan motor and circulating water pump motor power inputs to be added in the amount of 10.0 W per 1,000 Btu/h cooling capacity.

Table 6. Informative Guidance for Using AHRI Standard 210/240

		General Testing and Set-up Issues	Rating Procedure Issues			Calculations			
			General	Cooling	Heating	General	Cooling	Heating	
Requirements for all units		5.1.1, 5.1.3, 5.1.4, 5.1.7, 5.2, Section 5, Section 6, Appendix D, Appendix E, E1, E3, E4, E7, E8, E9, E11, E13, E14, E15.2, E17, E18, F1, F2, F3.2, F4, F5, F7, F8, F9, F10, F14, Appendix I	5.1.1, 6.1, Table 7, Table 8, 6.1.1, 6.1.2, 6.1.3, 6.1.4, 6.1.5.1, Table 11, 6.1.8, 6.5, 6.5.2, 6.5.3, 6.5.4, 6.5.5,	6.1.5	6.1.5.5, 6.1.5.7	11.3	11.1.1 to 11.1.6, 11.2.1	11.1.7 to 11.1.15, 11.2.2	
Requirements for all Heat Pumps		5.1.5, 5.1.7.3, E16, F11	6.1.6, 6.1.7, 6.1.8.4, 6.5.1.4	F12	F11, F13				
Additional Requirements	System Configurations (more than one may apply)	Blower Coil System	5.1.6, E5, D4.5, D5.1.1, D7.1.2.1						
		Coil-only System	5.1.6, D4.4, D5.1.1, D7.1.2.1,	6.1	6.1.5.3.1				
		Non-ducted System	E12, F3.1, F3.3, F6		6.1.5.1.4, 6.1.5.3.4, F12.9	6.1.5.6.4			
		Outdoor Unit with no match	5.1.6.2, 5.1.6.3	6.1.8.6, 6.5.1.6	6.1.3.1.4				
		Single-package	5.1.7.4, E5, D5.2.1,	6.1.8.7, 6.5.1.1					
		Heat pump Heating-only heat pump				6.1.5.5.5, 6.1.5.6.6, 6.1.5.6.7			
		Water-cooled and Evaporatively-cooled		6.1, Table 9, 6.2, Appendix G					
		Two-capacity Northern Heat Pump			6.1.5.3	6.1.3.4, 6.1.5.5.4, 6.1.5.6.5			
		Triple-capacity Northern Heat Pump			6.1.5.3, 6.1.5.4	6.1.3.4, 6.1.5.5.4, 6.1.5.6.5			
		SDHV	E6	Table 11, 6.5.3.3.3					
	Multi-split	5.1.6.1, E10	6.1.8.5, 6.5.1.7, 6.5.3.3						
	Modulation	Single speed compressor		6.1.8.1, 6.5.1.2	6.1.3.1.1	6.1.3.2.1		11.2.1.1	11.2.2.1
		Two-capacity compressor		6.1.8.2, 6.5.1.2	6.1.3.1.2, 6.1.5.3,	6.1.3.2.2, 6.1.3.4, 6.1.5.6		11.2.1.2	11.2.2.2
		Variable Speed Compressor	5.1.2, E2		6.1.3.1.3, 6.1.5.4	6.1.3.2.3, 6.1.5.7, 6.1.5.8		11.2.1.3	11.2.2.3
	Special	Heat Pump with Heat Comfort Controller							11.2.2.4
		Units with a Multi-speed Outdoor Fan	E15.1						
Single Indoor Unit Having Multiple Indoor Blowers									
ICM		5.1.1.1, , 5.1.7.2	6.1.8.3, 6.5.1.4, 6.5.1.5						

Table 7. Required Tests¹

Test Name				Product Type						
New Version	Former Version			Air-cooled					Evaporatively-cooled Air-conditioner	Water-cooled Air-conditioner
	Single	Two	Variable	Single Stage System	Two-stage System	Two-stage Northern	Variable Stage System	Triple-capacity Northern		
Cooling Mode²										
A _{Full}	A	A ₂	A ₂	R	R	R	R	R	R	R
B _{Full}	B	B ₂	B ₂	R	R	R	R	R		
B _{Low}	-	B ₁	B ₁		R ⁴		R	R ⁴		
C _{Full}	C	C ₂	C ₂	O ³	O ³	O ³		O ³		
C _{Low}	-	C ₁	C ₁		O ³			O ³		
D _{Full}	D	D ₂	D ₂	O ³	O ³	O ³		O ³		
D _{Low}	-	D ₁	D ₁		O ³			O ³		
E _{Int}	-	-	E _V				R			
F _{Low}	-	F ₁	F ₁		R		R	R		
G _{Low}	-	-	G ₁				O ³			
I _{Low}	-	-	I ₁				O ³			
Cooling Mode Operation Tests^{2,4,6}										
Voltage Tolerance				R	R	R	R	R	R	R
Low Temperature Cooling				R	R	R	R	R	R	R
Insulation Efficiency				R	R	R	R	R	R	R
Condensate Disposal				R	R	R	R	R	R	R
Maximum Operating Conditions				R	R	R	R	R	R	R
Heating Mode⁵										
H0 _{Low}	-	H0 ₁	H0 ₁		R	R	R	R		
H0C _{Low}	-	-	H0C ₁				O ⁶			
H1 _{Full}	H1	H1 ₂	H1 ₂	R	R	R	O	R		
H1 _{Low}	-	H1 ₁	H1 ₁		R	R	R	R		
H1C _{Full}	H1C	H1C ₂	H1C ₂	O ⁶	O ⁶	O ⁶	O ⁶	O ⁶		
H1C _{Low}	-	H1C ₁	H1C ₁		O ⁶	O ⁶	O ⁶	O ⁶		
H1 _{Nom}	-	-	H1 _N				R			
H2 _{Boost}	-	-	-					O		
H2 _{Full}	H2	H2 ₂	H2 ₂	R	R	R	O	R		
H2 _{Low}	-	H2 ₁	H2 ₁		O ⁷	O ⁷		O ⁷		
H2 _{Int}	-	-	H2 _V				R			
H3 _{Full}	H3	H3 ₂	H3 ₂	R	R	R	R	R		
H3 _{Low}	-	H3 ₁	H3 ₁		R ⁸	R ⁸		R ⁸		
H3 _{Boost}	-	-	-					R		
H3C _{Boost}								O		
H4 _{Boost}	-	-	-					R		
Heating Mode Operation Tests^{3,4,6}										
Voltage Tolerance				R	R	R	R	R		
Maximum Operating Conditions				R	R	R	R	R		

- Notes:
1. "R" means Required, "O" means Optional, and a blank cell indicates test is not applicable for the given product type.
 2. Required for any unit that has a cooling mode function.
 3. Refer to Section 6.1.3.1.
 4. See AHRI Unitary Small Equipment Operation Manual for details.
 5. Required for any unit that has a heating mode function.
 6. Refer to Section 6.1.3.2.
 7. Not necessary if low-capacity compressor heat pump performance at outdoor temperatures less than 37.0°F is not needed to calculate the HSPF per Section 11. Also, instead of testing, the H2 Low capacity and electrical power may be approximated based on H1Low and H3Low tests per Section 6.1.3.4.
 8. Required only if the heat pumps performance when operating at low compressor capacity and outdoor temperatures less than 37.0°F is needed to complete the HSPF calculation per Section 11.

Table 8. Test Conditions for Air-cooled Products

Test Name	Air Entering Outdoor Unit ² (°F)	Air Entering Indoor Unit ² (°F)	Compressor Speed ³	Indoor Airflow ⁴
Cooling Mode				
A _{Full}	95.0 / 75.0 ^{5,6}	80.0 / 67.0	Full _C ¹²	Full _C ¹²
B _{Full}	82.0 / 65.0 ^{5,6}	80.0 / 67.0	Full _C	Full _C
B _{Low}	82.0 / 65.0 ^{5,6}	80.0 / 67.0	Low _C	Low _C
C _{Full}	82.0 / 58.0 ^{5,6}	80.0 / 57.0 ⁷	Full _C	Full _C
C _{Low}	82.0 / 58.0 ^{5,6}	80.0 / 57.0 ⁷	Low _C	Low _C
D _{Full}	82.0 / 58.0 ^{5,6}	80.0 / 57.0 ⁷	Full _C	Full _C ⁸
D _{Low}	82.0 / 58.0 ^{5,6}	80.0 / 57.0 ⁷	Low _C	Low _C ⁸
E _{Int}	87.0 / 69.0 ^{5,6}	80.0 / 67.0	Int _C	Int _C
F _{Low}	67.0 / 53.5 ^{5,6}	80.0 / 67.0	Low _C	Low _C
G _{Low}	67.0 / 58.0 ^{5,6}	80.0 / 57.0 ⁷	Low _C	Low _C
I _{Low}	67.0 / 58.0 ^{5,6}	80.0 / 57.0 ⁷	Low _C	Low _C ⁸
Cooling Mode Operation Tests				
Voltage Tolerance	95.0 / 75.0 ⁵	80.0 / 67.0	Full _C	Full _C
Low Temperature	67.0 / 57.0	67.0 / 57.0	Full _C	Full _C
Insulation Efficiency	80.0 / 75.0	80.0 / 75.0	Full _C	Full _C
Condensate Disposal	80.0 / 75.0	80.0 / 75.0	Full _C	Full _C
Maximum Operation	115.0 / --	80.0 / 67.0	Full _C	Full _C
Extra High Maximum Operation (Optional)	125.6 / --	80.0 / 67.0	Full _C	Full _C
Heating Mode				
H0 _{Low}	62.0 / 56.5	70.0 / 60.0 ⁹	Low _H	Low _H
H0C _{Low}	62.0 / 56.5	70.0 / 60.0 ⁹	Low _H	Low _H
H1 _{Full}	47.0 / 43.0	70.0 / 60.0 ⁹	Full _H	Full _H
H1 _{Low}	47.0 / 43.0	70.0 / 60.0 ⁹	Low _H	Low _H
H1C _{Full}	47.0 / 43.0	70.0 / 60.0 ⁹	Full _H	Full _H ⁸
H1C _{Low}	47.0 / 43.0	70.0 / 60.0 ⁹	Low _H	Low _H ⁸
H1 _{Nom}	47.0 / 43.0	70.0 / 60.0 ⁹	Nom _H ¹⁵	Nom _H ¹⁰
H2 _{Boost}	35.0 / 33.0	70.0 / 60.0 ⁹	Boost _H	Full _H
H2 _{Full}	35.0 / 33.0	70.0 / 60.0 ⁹	Full _H	Full _H
H2 _{Low}	35.0 / 33.0	70.0 / 60.0 ⁹	Low _H	Low _H
H2 _{Int}	35.0 / 33.0	70.0 / 60.0 ⁹	Int _H	Int _H
H3 _{Full}	17.0 / 15.0	70.0 / 60.0 ⁹	Full _H	Full _H
H3 _{Low}	17.0 / 15.0	70.0 / 60.0 ⁹	Low _H	Low _H
H3 _{Boost}	17.0 / 15.0	70.0 / 60.0 ⁹	Boost _H	Full _H
H3C _{Boost}	17.0 / 15.0	70.0 / 60.0 ⁹	Boost _H	Full _H
H4 _{Boost}	5.0 / 3.0 ¹¹	70.0 / 60.0 ⁹	Boost _H	Full _H
Heating Mode Operation Tests				
Voltage Tolerance	47.0 / 43.0	70.0 / 60.0 ⁹	Full _H	Full _H
Maximum Operation	75.0 / 65.0	80.0 / --	Full _H	Full _H

Notes:

1. Test condition tolerances are defined within ASHRAE Standard 37, ASHRAE Standard 116 Table 3b for cyclic, and Section 8.7 of this standard.
2. Values listed are dry bulb temperature / wet bulb temperature, °F.
3. Refer to Section 3 for definition of “Full”, “Low”, “Int” and “Boost” for each compressor type.
4. Refer Section 6.1.5 for airflow details.
5. Wet-bulb required only if unit rejects condensate to Outdoor Coil.
6. For Single Package Units that do not reject condensate to the Outdoor Coil, where all or part of the equipment is located in the outdoor room, run a wet bulb such that the dew point is 60.5 ± 3.0 °F.
7. The entering air must have a low enough moisture content so no condensate forms on the indoor coil (It is recommended that an indoor wet-bulb temperature of 57.0 °F or less be used.)

Table 8. Test Conditions for Air-cooled Products (Continued)

8. For Cyclic Tests use the same airflow as steady state test which is defined as the same static pressure difference or velocity pressures across the nozzle(s) during the ON period.
9. Maximum value for all tests. If outdoor air enthalpy method is used for Single Package Heat Pumps, then the wet bulb shall be adjusted to match as close as reasonably possibly to the dew point of the outdoor entering air. Applies only to wet-bulb.
10. Refer to Section 6.1.5.8.
11. 3.0 Maximum.
12. For Two-stage Northern Heat Pump, Full_C is low stage compressor & airflow.
13. For Three-stage Northern Heat Pump, Full_C is middle stage compressor/airflow, Low_C is lowest stage compressor and airflow. Note: Tests D_{Full}, D_{Low}, I_{Low}, H1C_{Full}, and H1C_{Low} are cyclic in nature. Some heating tests, particularly H2_{Full} and H2_{Low} will be transient in nature. All other tests are Steady State Tests.
14. For Single Package Units that do not reject condensate to the Outdoor Coil, where all or part of the equipment is located in the outdoor room, run a wet bulb less than 58 °F.
15. For a cooling/heating heat pump, the Nominal Compressor Speed used for the H1_{Nom} test shall be at a speed, measured by RPM or power input frequency (Hz), no lower than the speed used in the A_{Full} test if the tested H1_{Full} heating capacity is less than the tested cooling capacity in A_{Full} test.

Table 9. Test Conditions for Water-cooled and Evaporatively-cooled Air-conditioner Products^{1,2}

Test Name	Air Entering Outdoor Unit ^{3,5} , °F	Air Entering Indoor Unit ³ , °F	Evaporatively-cooled	Water-cooled		Compressor Speed ⁴	Indoor Airflow or Water Flow Rate ⁴
			Make-up Water, °F	Condenser Inlet, °F	Condenser Outlet, °F		
Cooling Mode							
A _{Full}	95.0 / 75.0	80.0 / 67.0	85.0	85.0	95.0	Full _C	Full _C
IEER Part Load	Varies ⁶	80.0 / 67.0	77.0	Varies ⁶		Varies ⁶	Varies ⁶
Cooling Mode Operation Tests							
Voltage Tolerance	95.0 / 75.0	80.0 / 67.0	67.0		70.0	Full _C	Full _C
Low Temperature	67.0 / 57.0	67.0 / 57.0	67.0		70.0	Full _C	Full _C
Insulation Efficiency	80.0 / 75.0	80.0 / 75.0	85.0		80.0	Full _C	Full _C
Condensate Disposal	80.0 / 75.0	80.0 / 75.0	85.0		80.0	Full _C	Full _C
Maximum Operation	100.0 / 80.0	80.0 / 67.0	90.0	90.0	100.0	Full _C	Full _C

Notes:

1. Test condition tolerances are defined within ASHRAE Standard 37 and Section 8.7 of this standard.
2. A blank cell indicates test is not applicable for the given product type.
3. Values listed are dry bulb temperature / wet bulb temperature, °F.
4. Refer to Section 3 for definition of “Full” for the compressor type
5. Not required for Water-cooled Air-conditioners.
6. Varies with load, see Table 12.

6.1.1 Values of Standard Capacity Ratings. These ratings shall be expressed only in terms of Btu/h as shown in Table 10.

Table 10. Values of Standard Capacity Ratings

Capacity Ratings, Btu/h	Multiples, Btu/h
< 20,000	100
≥ 20,000 and < 38,000	200
≥ 38,000 and < 65,000	500

6.1.2 Values of Measures of Energy Efficiency and Power. Standard measures of energy efficiency, whenever published, shall be expressed in multiples of the nearest 0.02 W/W for COP, 0.05 Btu/(W·h) for EER, SEER and HSPF,

and 0.10 Btu/(W·h) for IEER. Standard measures of Off-mode Power Consumption, $P_{W,Off}$, shall be rounded to the nearest watt.

6.1.3 *Standard Rating Tests.*

6.1.3.1 *Default Cooling Degradation Coefficient.*

6.1.3.1.1 For Single Stage Systems, if the optional C_{Full} and D_{Full} tests are not performed, a default value of 0.20 shall be used for the cooling Degradation Coefficient, C_D^c .

6.1.3.1.2 For Two-capacity Systems, if the optional C_{Low} and D_{Low} tests are not performed, a default value of 0.20 shall be used for the low stage cooling Degradation Coefficient, $C_D^{c,Low}$. In this case, if using default value for $C_D^{c,Low}$, use default value for $C_D^{c,Full}$. For Two-capacity Systems that lock out low capacity operation at high outdoor temperatures, if the optional C_{Full} and D_{Full} tests are not performed, the default value for high stage shall be the value used for low stage.

6.1.3.1.3 For Variable Capacity Systems, if the optional G_{Low} and I_{Low} tests are not performed, a default value of 0.25 shall be used for the cooling Degradation Coefficient, C_D^c .

6.1.3.1.4 For OUWNM, if the optional C_{Full} and D_{Full} tests are not performed, a default value of 0.25 shall be used for the cooling Degradation Coefficient, C_D^c .

6.1.3.2 *Default Heating Degradation Coefficient.*

6.1.3.2.1 For Single Stage Systems, if the optional $H1C_{Full}$ test is not performed, a default value of 0.25 shall be used for the heating Degradation Coefficient, C_D^h .

6.1.3.2.2 For Two-capacity Systems and Triple-capacity Northern Heat Pumps, if the optional $H1C_{Full}$ and $H1C_{Low}$ tests are not performed, a default value of 0.25 shall be used for the low stage heating Degradation Coefficient, $C_D^{h,Low}$. In this case, if using default value for $C_D^{h,Low}$, use default value for $C_D^{h,Full}$. For Two-capacity Systems that lock out low capacity operation at low outdoor temperatures, if the optional $H1C_{Full}$ test is not performed, the default value for high stage shall be the value used for low stage. Additionally, for Triple-capacity Northern Heat Pumps if the optional $H3C_{Boost}$ is not performed, the default value 0.25 shall be used.

6.1.3.2.3 For Variable Capacity Systems, if the optional $H0C_{Full}$ and $H0C_{Low}$ tests are not performed, a default value of 0.25 shall be used for the heating Degradation Coefficient, C_D^h .

6.1.3.3 *Test Sequence.* When testing a Ducted System (except if a heating-only heat pump), conduct the A_{Full} test first to establish the cooling full-load air volume rate. For ducted heat pumps where the heating and cooling full-load air volume rates are different, make the first heating mode test one that requires the heating full-load air volume rate. For ducted heating-only heat pumps, conduct the $H1_{Full}$ Test first to establish the heating full-load air volume rate. When conducting a Cyclic Test, always conduct it immediately after the Steady State Test that requires the same test conditions. For Variable Speed Systems, the first test using the cooling minimum air volume rate shall precede the E_{Int} test, and the first test using the heating minimum air volume rate shall precede the $H2_{Int}$ test. The test laboratory makes all other decisions on the test sequence.

6.1.3.4 *Low-Capacity Heating Tests in 35 °F Conditions for Two-Stage Heat Pumps and Northern Two-stage and Triple-capacity Northern Heat Pumps.* Instead of conducting the $H2_{Low}$ test, capacity and power for this condition shall be calculated per Equation 11.36 and Equation 11.42.

6.1.4 *Electrical Conditions.* For products with a single nameplate rated voltage, Standard Rating tests shall be performed at the nameplate rated voltage. For dual nameplate voltage equipment where 230 V or 240 V is the higher of the dual nameplate voltages, Standard Rating tests shall be performed at 230 V. For all other dual nameplate voltage equipment covered by this standard, the Standard Rating tests shall be performed at both voltages or at the lower of the two voltages if only a single Standard Rating is to be published. For Split Systems, if the Indoor Unit has a different nameplate voltage than the Outdoor Unit, use the Indoor Unit nameplate voltage for the operation of the Indoor Unit. However, if either the indoor or the Outdoor Unit has a 208 V or 200 V nameplate voltage and the other unit has a 230 V nameplate rating, select the voltage supply on the Outdoor Unit for testing. Otherwise, supply each unit with its own nameplate voltage.

6.1.4.1 Frequency. For equipment which is 60 Hz only or 50 Hz only, Standard Ratings shall be provided at rated frequency. For equipment which can be operated at both 50 and 60 Hz, Standard Ratings shall be provided for each frequency, but tests shall be performed, at a minimum, at 60 Hz.

6.1.5 Airflow Through The Indoor Coil.

6.1.5.1 General Indoor Airflow Concerns.

6.1.5.1.1 Airflow-control Setting. Airflow-control Setting(s) shall be determined before testing begins. Unless otherwise specified within Section 6.1.5 or its subsections, no changes shall be made to the Airflow-control Setting(s) after initiation of testing.

6.1.5.1.2 Ducted Systems with a PSC AMS or a Constant-torque AMS Operating on Intermediate or Low Stage. For any test other than A_{Full} , the specified airflow rate for a given test shall not cause the external static pressure during any test calling for low or intermediate airflow rate to go below the minimum external static pressure values specified in Equation 6.1.

$$\Delta P_{st_i} = \Delta P_{st_{A,Full}} \cdot \left[\frac{\dot{Q}_{i,x}}{\dot{Q}_{A,Full}} \right]^2 \quad 6.1$$

6.1.5.1.3 Constant-volume AMS Static Settings. For any Steady-State Test using a Constant-volume AMS, if attempts to achieve the minimum external static pressure causes either air volume rate variations Q_{var} (as defined by Equation 6.2) of more than 10% or an automatic shutdown of the indoor blower, then the following procedure shall be used. These additional test steps are required if the measured external static pressure exceeds the target value by more than 0.03 in H_2O .

$$Q_{var} = \left[\frac{\dot{Q}_{max} - \dot{Q}_{min}}{\left(\frac{\dot{Q}_{max} + \dot{Q}_{min}}{2} \right)} \right] \cdot 100 \quad 6.2$$

6.1.5.1.3.1 Measure and record the average power consumption of the indoor fan motor ($\dot{E}_{fan,1}$) and record the corresponding external static pressure (ESP_1) at the ambient conditions for the given test at the lowest external static pressure where the unit will run with stability (Q_{var} remains below 10%) for a minimum of 5 minutes.

6.1.5.1.3.2 After completing the 5-minute minimum interval and while maintaining the same test conditions, adjust the exhaust fan of the airflow measuring apparatus until the external static pressure increases to approximately the value defined by Equation 6.3:

$$ESP_2 \approx ESP_1 + (ESP_1 - ESP_{min}) \quad 6.3$$

6.1.5.1.3.3 Upon achieving steady state at the higher external static pressure ESP_2 condition, record average power consumption and average external static pressure.

6.1.5.1.3.4 Calculate the average power consumption of the indoor fan motor at ESP_{min} using linear extrapolation. For all Steady-state Tests, the Total Power consumption shall be adjusted by P_{adj} as calculated per Equation 6.4. The adjustments are as shown in Section 11 equations.

$$P_{adj} = \frac{(P_{fan,2} - P_{fan,1})}{(ESP_2 - ESP_1)} \cdot (ESP_{min} - ESP_1) \quad 6.4$$

6.1.5.1.3.5 For all Steady-state Tests, total cooling capacity shall be increased and total heating capacity shall be decreased by \dot{q}_{adj} as calculated per Equation 6.5, as shown in Section 11.

$$\dot{q}_{adj} = 3.412 \cdot P_{adj} \quad 6.5$$

6.1.5.1.4 *Non-ducted Systems.* All airflow rates shall be the air volume rate that results during each test when the unit is operated at an external static pressure of 0.00 in H₂O.

6.1.5.1.5 *Overspeeding.* If a unit’s controls allow for overspeeding the indoor blower (usually on a temporary basis), take the necessary steps to prevent overspeeding during all tests.

6.1.5.1.6 *Full Airflow Adjustment to Meet Minimum External Static Pressure.* For cooling full airflow rate, or for heating full airflow rate on heating-only heat pumps, if external static pressure is lower than the minimum values specified in Table 11 at the manufacturer’s specified cooling full airflow rate or heating full airflow rate, the external static pressure shall be increased by reducing the airflow rate of the airflow measuring apparatus. If increasing external static pressure reduces airflow of the unit under test to less than 90% of rated airflow rate and the minimum external static pressure is still not achieved, then the next higher Airflow-control Setting (if available) shall be utilized to obtain rated airflow. If a higher Airflow-control Setting is not available, continue to decrease airflow rate of the airflow measuring apparatus until the required minimum external static pressure is achieved and use the resulting airflow of the unit under test as the cooling full airflow rate or heating full airflow rate as appropriate. Any manual Airflow-control Setting shall remain unchanged for all other tests.

6.1.5.1.7 *Other Airflow Adjustment to Meet Minimum External Static Pressure.* During a Low Stage or Intermediate Stage test, if the external static pressure is lower than the minimum values calculated per Equation 6.1 at manufacturer specified airflow rate, the external static pressure shall be increased by reducing the airflow rate of the airflow measuring apparatus. If increasing external static pressure reduces airflow of the unit under test to less than 90% of rated manufacturer specified airflow rate and the minimum external static pressure is still not achieved, then the next higher Airflow-control Setting (if available) shall be utilized to obtain rated airflow. If a higher Airflow-control Setting is not available, continue to decrease airflow rate of the airflow measuring apparatus until the required minimum external static pressure is achieved and use the resulting airflow of the unit under test as the cooling full airflow rate. Manual adjustments of Airflow-control Settings are not permitted.

6.1.5.1.8 *Units That Control To Different Constant Airflow At Each Test Condition Using The Same Blower Setting.* Use full-load, intermediate, and minimum air volume rates at each test condition that represent normal installation. Additionally, if conducting the dry-coil tests on variable speed equipment, operate the unit in the same control mode as used for the F1 Test. If performed, conduct the steady-state C Test and the cyclic D Test with the single speed or two speed unit operating in the same control mode as used for the B or B1 Test.

The target external static pressure, $\Delta P_{st,i}$, for any test “i” with a measured air volume rate not equal to the Cooling full-load air volume rate is determined as follows:

$$\Delta P_{st_i} = \Delta P_{st_{Full}} \cdot \left[\frac{Q_i}{Q_{Full}} \right]^2 \quad 6.6$$

External static pressure shall be controlled within -0.00 to +0.03 in H₂O of the target minimum external static pressure.

6.1.5.2 *Cooling Full Airflow Rate.* The manufacturer shall specify the cooling full airflow rate, $Q_{A,Full}$. The specified cooling full airflow rate value shall be utilized for all tests that call for cooling full airflow rate, unless otherwise modified by the following subsections. If modified, that same modified value shall be utilized for all tests that call for cooling full airflow rate. Static pressure requirements only apply to the A_{Full} test unless otherwise indicated.

6.1.5.2.1 *Coil-only Systems.* The specified cooling full airflow rate shall not cause air static pressure drop across the Indoor Unit during the A_{Full} test to exceed 0.30 in H₂O. If this maximum static is exceeded, reduce the airflow rate with no minimum until the maximum static is achieved.

6.1.5.2.2 *PSC AMS or Constant-torque AMS Ducted Systems.* The specified cooling full airflow rate shall not cause the external static pressure during the A_{Full} to go below the minimum values specified in Table 11. See Section 6.1.5.1.6.

Table 11. Minimum External Static Pressure for Ducted Systems Tested with an Indoor AMS Installed		
Rated Cooling ¹ or Heating ² Capacity, Btu/h	Minimum External Resistance ³ , in H ₂ O	
	All Other Systems	Small-duct, High-velocity Systems ⁴
Up Through 28,800	0.10	1.10
29,000 to 42,500	0.15	1.15
43,000 to 65,000	0.20	1.20

Note:

- 1 For air-conditioners and heat pumps, the value cited by the manufacturer in published literature for the unit's capacity when operated at the A_{Full} Test conditions.
- 2 For heating-only heat pumps, the value the manufacturer cites in published literature for the unit's capacity when operated at the HI_{Full} Test conditions.
- 3 For Ducted Systems tested without an air filter installed, increase the applicable tabular value by 0.08 in H₂O.
- 4 If a closed-loop, air-enthalpy test apparatus is used on the indoor side, limit the resistance to airflow on the inlet side of the Indoor Unit to a maximum value of 0.1 in H₂O. Impose the balance of the airflow resistance on the outlet side of the Indoor Unit.

6.1.5.2.3 *Constant-volume AMS Ducted Systems.* All tests requiring cooling full airflow rate shall be performed at the minimum external static pressure values specified in Table 11, with a tolerance of 0.00 to +0.03 in H₂O using the manufacturer's specified Airflow-control Setting. If the manufacturer does not specify an Airflow-control Setting, the manufacturer's airflow tables shall be used to determine the appropriate Airflow-control Setting.

6.1.5.3 *Cooling Low Airflow Rate.* The manufacturer shall specify the cooling low airflow rate. The specified cooling low airflow rate value shall be utilized for all tests that call for cooling low airflow rate, unless otherwise modified by the following subsections. If modified, that same modified value shall be utilized for all tests that call for cooling full airflow rate.

6.1.5.3.1 *Coil-only Systems.* The manufacturer specified cooling low airflow rate shall not be less than 75% of the cooling full airflow rate. This cooling low airflow rate shall be utilized regardless of the pressure drop across the indoor coil assembly.

6.1.5.3.2 *PSC AMS or Constant-torque AMS Ducted Systems.* The specified cooling low airflow rate shall not cause the external static pressure during any test calling for cooling low airflow rate to go below the minimum values calculated by Equation 6.1. Refer to Section 6.1.5.1.7. For products that do not have automatic control of Airflow-control Settings, the manual Airflow-control Setting from cooling full airflow rate shall remain unchanged.

For products that allow independent Airflow-control Settings, all low stage cooling tests shall be performed at cooling low airflow rate at the lowest Airflow-control Setting that meets the low stage minimum external static pressure per Equation 6.1. Refer to Section 6.1.5.1.7.

6.1.5.3.3 *Constant-volume AMS Ducted Systems.* All tests requiring cooling low airflow rate shall be performed at the minimum external static pressure values specified in Equation 6.1, with a tolerance of 0.00 to +0.03 in H₂O using the manufacturer's specified Airflow-control Setting. If the manufacturer does not specify an Airflow-control Setting, the manufacturer's airflow tables shall be used to determine the appropriate Airflow-control Setting. If the static pressure setting causes air volume rate variations (Q_{var}) more than 10% or an automatic shutdown of the indoor blower, the procedure from Section 6.1.5.1.3 shall be used.

6.1.5.3.4 *Non-ducted Systems.* The cooling low airflow rate is the air volume rate that results during each test when the unit is operated at an external static pressure of 0.00 in H₂O and at the indoor fan setting used at Low Compressor Stage (Two-capacity System) or OUM's Minimum Compressor Speed (Variable Capacity System). For units having a single speed compressor and a Constant-volume AMS or a Constant-torque AMS, use the lowest Airflow-control Setting allowed for cooling.

6.1.5.4 *Cooling Intermediate Airflow Rate.* The manufacturer shall specify the cooling intermediate airflow rate. The specified cooling intermediate airflow rate value shall be utilized for all tests that call for cooling intermediate airflow rate, unless otherwise modified by subsections of Section 6.1.3.3.3. If modified, that same modified value shall be utilized for all tests that call for cooling intermediate airflow rate.

6.1.5.4.1 *Coil-only Systems.* Variable speed Coil-only Systems are not addressed by this Standard. A manufacturer seeking to utilize variable speed in a Coil-only System shall apply to DOE for a test procedure waiver per 10 CFR §430.27.

6.1.5.4.2 *PSC AMS or Constant-torque AMS Ducted Systems.* The specified cooling intermediate airflow rate shall not cause the external static pressure during any test calling for cooling intermediate airflow rate to go below the minimum values calculated by Equation 6.1. Refer to Section 6.1.5.1.7. For products that do not have automatic control of Airflow-control Settings, the manual Airflow-control Setting from cooling full airflow rate shall remain unchanged.

For products that allow independent Airflow-control Setting selection, all intermediate stage cooling tests shall be performed at cooling intermediate airflow rate at the lowest Airflow-control Setting that meets the intermediate stage minimum external static pressure in Equation 6.1. Refer to Section 6.1.5.1.7.

6.1.5.4.3 *Constant-volume AMS Ducted Systems.* All tests requiring cooling intermediate airflow rate shall be performed at the minimum external static pressure values calculated using Equation 6.1, with a tolerance of 0.00 to +0.03 in H₂O.

6.1.5.5 *Heating Full Airflow Rate.* The manufacturer shall specify a heating full airflow rate, $\dot{Q}_{H1,Full}$, except as required by 6.1.5.5.1. The specified heating full airflow rate value shall be utilized for all tests that call for heating full airflow rate, unless otherwise modified by the following subsections. If modified, that same modified value shall be utilized for all tests that call for heating full airflow rate. Unless otherwise indicated, static pressure requirements only apply to the H1_{Full} test.

6.1.5.5.1 *Ducted Heat Pumps where the Heating Full Airflow Rate and Cooling Full Airflow Rate are the Same.* Use the cooling full airflow rate as the heating full airflow Rate for:

6.1.5.5.1.1 Coil-only Heat Pumps (except Two-capacity Northern Heat Pumps tested only at low capacity in cooling – see Section 6.1.5.5.5), or

6.1.5.5.1.2 PSC AMS or Constant-torque AMS ducted heat pumps which operate at the same indoor Airflow-control Setting during both A_{Full} and H1_{Full} tests, or

6.1.5.5.1.3 Constant-volume AMS ducted heat pumps which deliver the same air volume rate during both the A_{Full} and H1_{Full} tests.

No external static pressure requirements apply for heat pumps of Sections 6.1.5.5.1.1 and 6.1.5.5.1.2. Use the final indoor blower control settings as determined when setting the cooling full airflow rate, and readjust the exhaust fan of the airflow measuring apparatus if necessary to reset to the cooling full airflow rate. For heat pumps where the last bullet is applicable, test at the minimum external static pressure specified in Table 11 (0.00 to +0.03 in H₂O). If the static pressure setting causes air volume rate variations (Q_{var}) more than 10% or an automatic shutdown of the indoor blower, then use procedure from Section 6.1.5.1.3.

6.1.5.5.2 *PSC AMS or Constant-torque AMS Ducted Heat Pumps where the Heating Full Airflow Rate and Cooling Full Airflow Rates are Different Due to Automatic Indoor Fan or Controls Operation.* The specified heating full airflow rate shall not cause the external static pressure during any test calling for heating full airflow rate to go below the minimum values specified in Equation 6.1. Refer to Section 6.1.5.1.7.

6.1.5.5.3 *Constant-volume AMS Ducted Heat Pumps where the Heating Full Airflow Rate and Cooling Full Airflow Rates are Different Due to Automatic Indoor Fan or Controls Operation.* All tests shall be performed at the minimum external static pressure values specified in Equation 6.1, with a tolerance of 0.00 to +0.03 in H₂O.

6.1.5.5.4 *Ducted Two-capacity and Triple-capacity Northern Heat Pumps.* Select the appropriate approach from 6.1.5.5.2 or 6.1.5.5.3 cases above for units that are tested with an indoor fan installed. For coil-only northern heat pumps, the heating full airflow rate is the lesser of the rate specified by the manufacturer or 133% of the cooling full airflow rate. For this latter case, obtain the heating full airflow rate regardless of the pressure drop across the indoor coil assembly.

6.1.5.5.5 *Heating Only Coil-only Heat Pumps.* The manufacturer specified heating full airflow rate shall not cause the pressure drop across the indoor coil during the $H1_{Full}$ to exceed 0.30 in H_2O . If the maximum static is exceeded, reduce airflow rate until maximum static is achieved.

6.1.5.5.6 *PSC AMS or Constant-torque AMS Ducted Heating-Only Heat Pumps.* The manufacturer specified heating full airflow rate shall not cause the external static pressure during the $H1_{Full}$ to go below the minimum values specified in Table 11. See Section 6.1.5.1.6.

6.1.5.5.7 *Constant-volume AMS Ducted Heating-Only Heat Pumps.* The manufacturer specified heating full airflow rate shall be performed at the minimum values specified in Table 11, with a tolerance of 0.00 to +0.03 in H_2O .

6.1.5.6 *Heating Low Airflow Rate.* The manufacturer shall specify a heating low airflow rate except as required by Section 6.1.5.6.1. The specified heating low airflow rate value shall be utilized for all tests that call for heating low airflow rate, unless otherwise modified by the following subsections. If modified, that same modified value shall be utilized for all tests that call for heating low airflow rate.

6.1.5.6.1 *Ducted Heat Pumps where the Heating Low Airflow Rate and Cooling Low Airflow Rate are the Same.* Use the cooling low airflow rate as the heating low airflow rate for:

6.1.5.6.1.1 *Coil-only Heat Pumps, or*

6.1.5.6.1.2 *PSC AMS or Constant-torque AMS ducted heat pumps which operate at the same Airflow-control Setting during both A_{Low} and $H1_{Low}$ tests, or*

6.1.5.6.1.3 *Constant-volume AMS ducted heat pumps which deliver the same air volume rate during both the A_{Low} and $H1_{Low}$ tests.*

No external static pressure requirements apply to the minimum static pressure for heat pumps that apply to the first two bullets. For heat pumps where the last bullet is applicable, test at the minimum external static pressure specified in Table 11 (0.00 to +0.03 in H_2O). If the static pressure setting causes air volume rate variations (Q_{var}) more than 10% or an automatic shutdown of the indoor blower, then use the procedure from Section 6.1.5.1.3.

6.1.5.6.2 *PSC AMS or Constant-torque AMS Ducted Heat Pumps where the Heating Low Airflow Rate and Cooling Low Airflow Rates are Different Due to Automatic Indoor Fan or Controls Operation.* For the initial test requiring the heating low airflow rate, the specified heating low airflow rate shall not cause the external static pressure to go below the minimum values specified in Equation 6.1. Refer to Section 6.1.5.1.7. For all subsequent tests requiring the heating low airflow rate, use the same heating low airflow rate from the initial test requiring the heating low airflow rate.

6.1.5.6.3 *Constant-volume AMS Ducted Heat Pumps where the Heating Low Airflow Rate and Cooling Low Airflow Rates are Different Due to Automatic Indoor Fan or Controls Operation.* All tests requiring heating low airflow rate shall be performed at the minimum external static pressure values specified in Equation 6.1, with a tolerance of 0.00 to +0.03 in H_2O .

6.1.5.6.4 *Non-ducted Heat Pumps, Including Non-ducted Heating-only Heat Pumps.* The heating low airflow rate is the air volume rate that results during each test when the unit operates at an external static pressure of 0.00 in H_2O and at the Airflow-control Setting used at Low Compressor Stage (Two-capacity System) or Low Compressor Speed (Variable Speed System). For units having a single speed compressor and a Constant-volume AMS or a Constant-torque AMS, use the lowest Airflow-control Setting permitted in the Installation Instructions.

6.1.5.6.5 *Ducted Two-capacity and Triple Capacity Northern Heat Pumps.* Select the appropriate approach from 6.1.5.6.2 or 6.1.5.6.3 cases above for units that are tested with an indoor fan installed. For Two-capacity Northern Heat Pumps which are Coil-only Heat Pumps, the heating low airflow rate is the higher of cooling full airflow rate or 75% of the heating full airflow rate. For *Coil-only Heat Pumps*, obtain the heating low airflow rate regardless of the pressure drop across the indoor coil assembly.

6.1.5.6.6 *Heating Only Coil-only Heat Pumps.* The manufacturer specified heating low airflow rate shall not be less than 75% of the heating full airflow rate.

6.1.5.6.7 *PSC AMS or Constant-torque AMS Ducted Heating-Only Heat Pumps.* The manufacturer specified heating low airflow rate shall not cause the external static pressure during any low stage heating test to go below the minimum values calculated from Equation 6.1.

6.1.5.6.8 *Constant-volume AMS Ducted Heating-Only Heat Pumps.* The manufacturer specified heating low airflow rate shall be performed at the minimum values calculated from Equation 6.1 with a tolerance of 0.00 to +0.03 in H₂O.

6.1.5.7 *Heating Intermediate Airflow Rate.* The manufacturer shall specify a heating intermediate airflow rate except as required by 6.1.5.7.1. The specified heating intermediate airflow rate value shall be utilized for all tests that call for heating intermediate airflow rate, unless otherwise modified by subsections of Section 6.1.5.7. If modified, that same modified value shall be utilized for all tests that call for heating intermediate airflow rate.

6.1.5.7.1 *Coil-only Heat Pumps where the Heating Intermediate Airflow Rate and Cooling Intermediate Airflow Rate are the Same.* See Section 6.1.5.4.1.

6.1.5.7.2 *PSC AMS or Constant-torque AMS Ducted Systems.* The specified heating intermediate airflow rate shall not cause the external static pressure during any test calling for heating intermediate airflow rate to go below the minimum values specified in Equation 6.1. See Section 6.1.5.1.7.

6.1.5.7.3 *Constant-volume AMS Ducted Systems.* All tests requiring heating intermediate airflow rate shall be performed at the minimum external static pressure values specified by Equation 6.1, with a tolerance of 0.00 to +0.03 in H₂O.

6.1.5.8 *Heating Nominal Airflow Rate.* The manufacturer shall specify a heating nominal airflow rate. the specified heating nominal airflow rate value shall be utilized for all tests that call for heating nominal airflow rate, except as noted below. If modified, that same modified value shall be utilized for all tests that call for heating nominal airflow rate.

The specified heating nominal airflow rate shall not cause the external static pressure during any test calling for heating nominal airflow rate to go below the minimum values specified in Equation 6.1.

6.1.6 *Outdoor-Coil Airflow Rate.* All Standard Ratings shall be determined at the outdoor coil airflow rate specified by the manufacturer where the fan drive is adjustable. Where the fan drive is non-adjustable, performance shall be determined at the outdoor coil airflow rate inherent in the equipment when operated with all of the resistance elements associated with inlets, louvers, and any ductwork and attachments considered by the manufacturer as normal installation practice, as determined by the manufacturer literature. Once established, the Outdoor Coil air circuit of the equipment shall remain unchanged throughout all tests prescribed herein.

6.1.6.1 *Double-duct System.* For product intended to be installed with the outdoor airflow ducted, the unit shall be installed with Outdoor Coil ductwork installed per the Installation Instructions and shall operate between 0.10 and 0.15 in H₂O external static pressure. External static pressure measurements shall be made in accordance with ASHRAE Standard 37 Sections 6.4 and 6.5.

6.1.7 *Control of Auxiliary Resistive Heating Elements.* Except as noted, disable heat pump resistance elements used for heating indoor air at all times, including during defrost cycles and non-defrost tests for units with a Heat Comfort Controller. For heat pumps equipped with a Heat Comfort Controller, enable the heat pump resistance elements only during the below-described, short test. The short test follows the H1_{Full} test or, if conducted, the H1C_{Full} test. Set the

Heat Comfort Controller to provide the maximum supply air temperature. With the heat pump operating and while maintaining $Q_{HI-Full}$, measure the temperature of the air leaving the indoor-side beginning 5 minutes after activating the Heat Comfort Controller. Sample the outlet dry-bulb temperature at regular intervals that span 5 minutes or less. Collect data for 10 minutes, obtaining at least 3 samples. Calculate the average outlet temperature (T_{cc}), °F, over the 10-minute interval.

6.1.8 *Tested Combinations or Tested Units.* As a minimum, Tested Combinations of Split Systems or tested samples of Single Package Unit shall include the following combination for the specific types of equipment listed. Unless otherwise specified below, there is no restriction on the Tested Combination (i.e., single split air conditioners and heat pumps not listed below shall be tested as a Coil-only System or a Blower Coil System).

6.1.8.1 *Single Stage Air Conditioner (Distributed in commerce by an OUM).* Any Single Stage Air Conditioner (including space-constrained and SDHV) shall be tested, as a minimum, as a Coil-only System.

6.1.8.2 *Two-stage Air Conditioner (Distributed in commerce by an OUM).* Any Two-stage Air Conditioner (including space-constrained and SDHV) shall be tested, as a minimum, as a Coil-only System.

6.1.8.3 *Single Split System Air Conditioner (Distributed in Commerce by an ICM).* Manufacturers shall test a model of Indoor Unit with the least efficient model of Outdoor Unit with which it shall be paired where the least efficient model of Outdoor Unit is the model of Outdoor Unit in the lowest SEER combination as certified by the OUM. If there are multiple models of Outdoor Unit with the same lowest SEER represented value, the ICM shall select one for testing purposes.

6.1.8.4 *Single Split System Heat Pump (Distributed in Commerce by an ICM).* Does not need to be tested as long as an equivalent air conditioner basic model has been tested. If an equivalent model has not been tested, manufacturers shall test a model of Indoor Unit with a model of Outdoor Unit meeting the same requirements listed as in Section 6.1.8.3 for Single-split Air-conditioner distributed in commerce by an ICM.

6.1.8.5 *Multi-split, Multi-Head Mini-Split, or Multi-Circuit System (including space-constrained and SDHV).* (See also Section 6.5.1.1.). An arrangement of Indoor Units and Outdoor Units that are production units, or are representative of production units and provides representative performance values, having the following features:

6.1.8.5.1 The system consists of one Outdoor Unit with one or more compressors matched with at least two but no more than five Indoor Units;

6.1.8.5.2 The Indoor Units shall:

6.1.8.5.2.1 Collectively, have a Nominal Cooling Capacity greater than or equal to 95% and less than or equal to 105% of the Nominal Cooling Capacity of the Outdoor Unit;

6.1.8.5.2.2 Each represent the highest sales volume model family (at the time the rating is established), if this is possible while meeting all the requirements of this section. If this is not possible, one or more of the Indoor Units shall represent another indoor model family in order that all the other requirements of this section are met.

6.1.8.5.2.3 Individually not have a Nominal Cooling Capacity greater than 50% of the Nominal Cooling Capacity of the Outdoor Unit, unless the Nominal Cooling Capacity of the Outdoor Unit is 24,000 Btu/h or less;

6.1.8.5.2.4 Operate at fan speeds consistent with manufacturer's specifications; and

6.1.8.5.2.5 All be subject to the same minimum external static pressure requirement while able to produce the same external static pressure at the exit of each outlet plenum when connected in a manifold configuration as required by the test procedure.

6.1.8.6 *Outdoor Unit with No Match.* The model of Outdoor Unit shall be tested with a model of Coil-only Indoor Unit meeting the requirements of Section 5.1.6.2.

6.1.8.7 *Single Package Air Conditioners and Heat Pumps (including space-constrained) Selected for Testing.* Manufacturers shall test the individual model with the lowest SEER.

6.2 *Part Load Rating.* All unitary Water-cooled and Evaporatively-cooled Air-conditioners rated in accordance with this standard (not applicable to Unitary Air-cooled Air-conditioners or Unitary Air-source Heat Pumps) shall include an Integrated Energy Efficiency Ratio (IEER), even if they have only one stage of cooling capacity control.

6.2.1 *IEER Background (Informative).* The IEER was developed to represent a single metric for the annualized performance of the mechanical cooling system. It is based on a volume weighted average of 3 building types and 17 climate zones and includes 4 rating points at 100%, 75%, 50%, and 25% load at condenser conditions seen during these load points. It includes all mechanical cooling energy, fan energy and other energy required to deliver the mechanical cooling, but excludes operating hours seen for just ventilation, economizer operation and does not include system options like demand ventilation, supply air reset, energy recovery and other system options that might be applied on a job. The purpose of the metric is to allow for comparison of mechanical cooling systems at a common industry metric set of conditions. It is not intended to be a metric for prediction of building energy use for the HVAC systems.

Building energy consumption varies significantly based on many factors including, but not limited to, local occupancy schedules, ambient conditions, building construction, building location, ventilation requirements and added features like economizers, energy recovery, evaporative cooling, etc. IEER is a comparative metric representing the integrated full load and part load annualized performance of the mechanical cooling of the air-conditioning unit over a range of operating conditions. It does not include performance of hybrid system features like economizers, energy recovery and heat reclaim. IEER is not intended to be a predictor of the annual energy consumption of a specific building in a given climate zone. To more accurately estimate energy consumption of a specific building an energy analysis using an hour-by-hour analysis program should be performed for the intended building using the local weather data.

6.2.2 *IEER Requirements.* The general equations used for calculation of the IEER are defined in Section 6.2.3.

To help in the application of the general equations, specific step by step procedures have been included in the following sections for various product classifications.

6.2.2.1 IEER for Fixed Capacity Control Units – See Section 6.2.4.

6.2.2.2 IEER for Staged Capacity Controlled Units – See Section 6.2.5.

6.2.2.3 IEER for Proportionally Controlled Units – See Section 6.2.6.

For examples showing the procedures for calculating the IEER see Appendix H.

6.2.3 *General IEER Equations.* For units covered by this standard, the IEER shall be calculated using test derived data and the following formula.

$$IEER = (0.020 \cdot A) + (0.617 \cdot B) + (0.238 \cdot C) + (0.125 \cdot D) \quad 6.7$$

The IEER rating requires that the unit efficiency be determined at 100%, 75%, 50%, and 25% percent load at the conditions specified in Table 12 and at the part load airflow rate, if different than the full load airflow rate.

The EER at 100% Net Capacity is the Standard Energy Efficiency Ratio. No additional test at 100% Net Capacity is required.

Table 12. IEER Part Load Rating Conditions^{1, 2, 3}

Indoor Air Return Air Dry-bulb Temperature Return Air Wet-bulb Temperature Indoor Airflow Rate	80.0 °F 67.0 °F Note 1
Condenser (Water-Cooled) Entering Condenser Water Temperature (EWT) Condenser Water Flow Rate, gpm	100% Load = 85 °F 75% Load = 73.5 °F 50% Load = 62.0 °F 25% load = 55.0 °F full load flow
Condenser (Evaporatively-cooled) Entering Wet-bulb Temperature (EWB)	100% Load = 74.5 °F 75% load = 66.2 °F 50% Load = 57.5 °F 25% Load = 52.8 °F
Note: <ol style="list-style-type: none"> 1. For fixed speed indoor fans the airflow rate shall be held constant at the full load Standard Air airflow rate ±3%. For VAV units the airflow rate at part load shall be adjusted to maintain the full load measured leaving air dry-bulb temperature and the external static pressure shall be reduced per the following equation. The tolerance for the leaving air dry-bulb temperature on VAV units is ±0.3 °F. For units using discrete step fan speed control, the fan speed shall be adjusted as specified by the controls and the external static pressure shall be reduced per the following equation based on Part Load Rated Airflow and shall be maintained at the value 0.00 to 0.05 in H₂O. For SZVAV units, the fan speed shall be adjusted as specified by the controls and the minimum external static shall be reduced per the equation below based on Part Load Rated Airflow. $ESP_{PL} = ESP_{FL} \cdot \left(\frac{scfm_{PL}}{scfm_{FL}} \right)^2$ Variable Speed MZVAV Fan Control - For MZVAV units, the airflow rate at part load shall be adjusted to maintain the supply air dry bulb temperature measured at full load within a tolerance of ±0.5°F and the minimum external static shall be reduced per the equation below based on the resulting part load airflow. If the full load measured leaving air dry-bulb cannot be met at part load rating conditions due to controls limitations of the unit capacity and airflow modulation, then the part load rating point shall be run at the minimum step of unloading and minimum fan speed allowed by the controls, and the external static per Equation above. 2. Condenser airflow shall be adjusted as required by Section 6.1.6. 3. For a valid test, the atmospheric pressure shall be 13.7 psia minimum. 	

6.2.4 Rating Adjustments. The IEER shall be determined at the 4 ratings loads and condenser conditions as defined in Table 12. If the unit is not capable of running at the 75%, 50%, or 25% load then Section 6.2.4.1 or Section 6.2.4.2 shall be followed to determine the rating at the required load.

6.2.4.1 Interpolation. If the units cannot run at the 75%, 50%, or 25% points within a tolerance of ±3% but is capable of running at load above and below the rating load of 75%, 50%, or 25% interpolation of the test points shall be used to determine the EER rating at the 75%, 50%, or 25% loads.

Note: In this edition of AHRI Standard 210/240, the part load rating condenser temperatures have been fixed at the 100%, 75%, 50%, and 25% values shown in Table 12. In the 2008 standard these were a function of the actual load. It does not impact the units that can run at the 75%, 50%, and 25% load conditions; however, for interpolating ratings the condenser temperature is now fixed at the 75%, 50%, and 25% rating points. As a result, two tests at different loads above and below the rating point shall be used for interpolating ratings. For example, if the unit is a water-cooled unit and the rating at a 75% load is being determined, but the unit can only run at 80% load and 60% load, then the unit can be run at those percent part loads at the same outdoor air temperature and the 75% rating can be interpolated (see Figure 1).

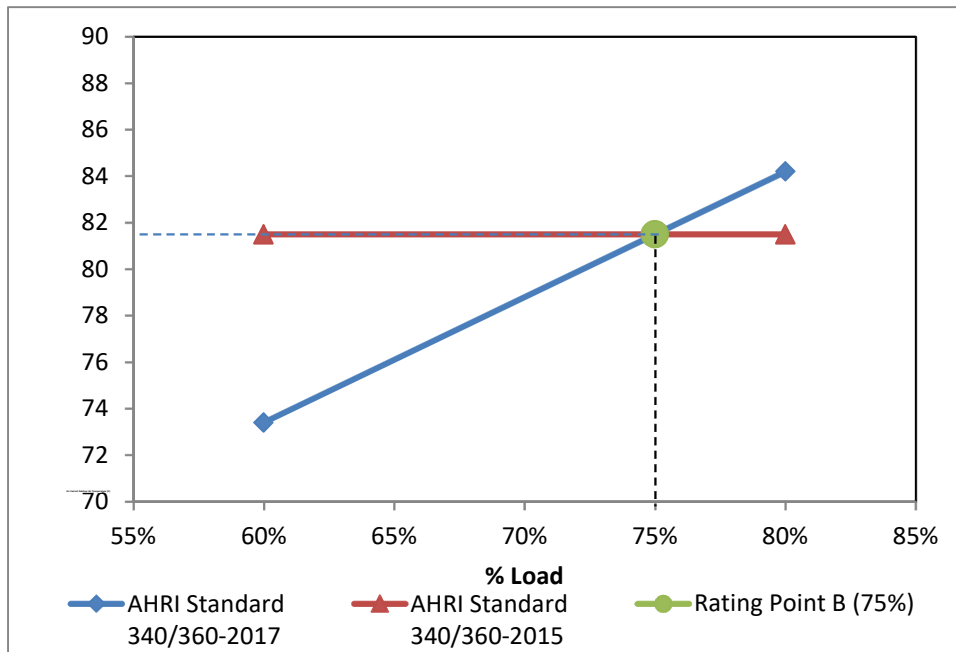

Figure 1. Example Revised Part Load Ambient Conditions for Interpolation

6.2.4.2 Degradation. If the unit cannot be unloaded to the 75%, 50%, or 25% load then the unit shall be run at the minimum step of unloading and minimum indoor airflow rate at the condenser conditions defined for each of the rating percent load IEER points listed in Table 12 and then the part load EER shall be adjusted for cyclic performance using the following equation

$$EER_x = \frac{LF \cdot \dot{Q}}{LF \cdot [C_D \cdot (P_C + P_{CD})] + P_{IF} + P_{CT}} \quad 6.8$$

C_D shall be determined using Equation 6.9.

$$C_D = (-0.13 \cdot LF) + 1.13 \quad 6.9$$

Where:

$$LF = \frac{\left(\frac{PL}{100}\right) \cdot \dot{q}_{A,Full}}{\dot{q}_{i,x}} \quad 6.10$$

6.2.5 Procedure for IEER Calculations for Fixed Capacity Control Units. For fixed capacity control units (Single Stage Systems), the IEER shall be calculated using data and Equation 6.7 and the following procedures.

The following sequential steps shall be followed:

6.2.5.1 Step 1. Each of the three part load rating point for 75%, 50% and 25% load shall be determined at the part load rating condenser entering temperature defined in Table 12 within tolerances defined in ANSI/ASHRAE Standard 37 Table 2b.

Note: Because the unit only has a single stage of capacity the actual percent load will be greater than the required rating percent load and will be adjusted cyclic performance using the degradation calculations as per step 3. Part load rated airflow, if different than full load airflow, shall be used as defined by the manufacturer, and with an external static pressure as specified in Table 12.

6.2.5.2 Step 2. The rating shall be adjusted for cyclic degradation using the procedures in Section 6.2.4.

6.2.5.3 *Step 3.* The test results including adjustments for cyclic degradation from step 3 shall then be used to calculate the IEER using the procedures defined in Section 6.2.3. For example calculations, see Appendix H.

6.2.6 *IEER for Staged Capacity Controlled Units.* For staged capacity controlled units covered by this standard, the IEER shall be calculated using Equation 6.7 and the following procedures.

Staged capacity controlled units, for test purposes, shall be provided with the manual means to adjust the stages of refrigeration capacity and the indoor fan speed to obtain the rated airflow with the tolerance defined in Table 12.

The following sequential steps shall be followed.

6.2.6.1 *Step 1.* For part load rating points, the unit shall be configured per the manufacturer’s instructions, including setting of stages of refrigeration for each part load rating point. The stages of refrigeration that result in capacity closest to the desired IEER part load rating EER point shall be used.

The condenser entering temperature shall be adjusted per the requirements of Table 12 within the tolerances defined in ANSI/ASHRAE Standard 37 Table 2b.

The indoor airflow rate and external static pressure shall be adjusted per the requirements of Table 12.

If the measured part load rating capacity ratio is within three percentage points, based on the full load measured test Net Capacity, above or below the part load rated capacity point, the EER at each load point shall be used to determine IEER without any interpolation (see Table 13).

Required Percent Load Point	Minimum Allowable Percent Load	Maximum Allowable Percent Load
75%	72%	78%
50%	47%	53%
25%	22%	28%

If the unit, due to its capacity control logic cannot be operated at the 75%, 50%, or 25% percent load within 3% tolerance, then an additional rating point is required and the 75%, 50%, or 25% EER is determined by using linear interpolation. Data shall not be extrapolated to determine EER.

The additional test point(s) for interpolations shall be run as follows:

6.2.6.1.1 The ambient test conditions shall be within tolerances defined in ANSI/ASHRAE Standard 37 Table 2b for the specified ambient in Table 12 for the required IEER part load rating of 75%, 50%, or 25%. Two tests points are required at the fixed temperature for the desired IEER part load point, one test point at a capacity stage above required load point and a second test point at a capacity stage below required load point. The data from the two test points shall then be used to interpolate the rating for the required load rating point. For example, a unit being tested to determine the EER rating at 50% load with a capacity stage at 60% and 30% displacement shall require one test at 60% displacement at a 68°F ambient and a second test at 30% displacement at a 68°F ambient. The test results are then interpolated to determine the 50% load rating point.

The indoor Standard Air airflow rate and static shall be adjusted per the requirements of Table 12.

6.2.6.1.2 The stages of refrigeration capacity are to be increased or decreased within the limit of the controls and until the measured part load is closest to the IEER percent part load rating point is obtained. It is not acceptable to use capacity for a stage of capacity that is higher or lower than the closest stage of capacity to the desired IEER rating point.

6.2.6.1.3 The measured part load capacity of the second test point shall be less than the part load rating capacity point if the measured capacity of the first test is greater than the part load rated capacity point.

6.2.6.1.4 The measured part load capacity of the second test point shall be more than the part load rating capacity point if the measured capacity of the first is less than the part load rated capacity point.

If the unit cannot be unloaded to the 75%, 50%, or 25% load points at the minimum stage of unloading then the rating shall be determined at the minimum stage of unloading and part load rating condenser entering temperature defined in Table 12 with a tolerance of $\pm 0.5^\circ\text{F}$.

Note: The actual percent load will be greater than the required percent load and shall be adjusted cyclic performance using the degradation calculations as per step 3. Part load rated airflow, if different than full load airflow, shall be used as defined by the manufacturer, and at an external static pressure as specified in Table 12.

6.2.6.2 *Step 2.* If the corrected rating points are within 3% of the desired IEER rating point of 75%, 50%, and 25%, they shall be used directly. If there are corrected ratings points above and below the desired IEER rating of 75%, 50%, and 25% then the rating data for the IEER rating point shall be determined using linear interpolation. If the corrected rated percent load is greater than the IEER rating for 75%, 50%, or 25% by more than 3% then the ratings data at the condenser temperature required for the rating point shall be used along with the degradation procedure defined in Section 6.2.

6.2.6.3 *Step 3.* The corrected rating point data from step 3 shall then be used to calculate the IEER using the procedures defined in Section 6.2.3.

6.2.7 *IEER for Proportionally Controlled Units.* For proportionally controlled units covered by this standard, the IEER shall be calculated using data and Equation 6.7 and the following procedures.

Proportionally controlled units, for test purposes, shall be provided with manual means to adjust the unit refrigeration capacity in steps no greater than 5% of the full load rated capacity by adjusting variable capacity compressor(s) capacity and or the stages of refrigeration capacity.

The following sequential steps shall be followed.

6.2.7.1 *Step 1.* For part load rating tests, the unit shall be configured per the manufacturer's instructions, including setting of stages of refrigeration and variable capacity compressor loading percent for each of the part load rating points. The stages of refrigeration and variable capacity compressor loading percent that result in capacity closest to the desired part load rating point of 75%, 50%, or 25%.

The condenser entering temperature shall be adjusted per the requirements of Table 12 and be within tolerance as defined in ANSI/ASHRAE Standard 37 Table 2b.

The indoor airflow and static shall be adjusted per Table 12.

If the measured part load rating capacity ratio is within $\pm 3\%$, based on the full load measured test Net Capacity, above or below the part load rated capacity point, the EER at each load point shall be used to determine IEER without any interpolation.

If the unit, due to its capacity control logic cannot be operated at the 75%, 50%, or 25% load within 3%, then an additional rating point(s) is required and the 75%, 50%, or 25% EER is determined by using linear interpolation. Extrapolation of the data is not allowed.

The additional test point(s) for interpolations shall be run as follows:

6.2.7.1.1 The ambient test conditions shall be within tolerances defined in ANSI/ASHRAE Standard 37 of the specified ambient in Table 12 based on the IEER rating point of 75%, 50%, or 25%.

Note: The condenser temperature shall be fixed for the two interpolation rating points at the values listed in Table 12.

6.2.7.1.2 The indoor airflow shall be set as specified by the manufacturer and as required by Table 12.

6.2.7.1.3 The stages of refrigeration capacity are to be increased or decreased within the limit of the controls and until the measured part load is closest to the IEER percent part load rating point. It is not acceptable to use capacity for a stage of capacity that is higher or lower than the closest stage of capacity to the desired IEER rating point.

6.2.7.1.4 The measured part load capacity of the second test point shall be less than the part load rating capacity point if the measured capacity of the first test is greater than the part load rated capacity point.

6.2.7.1.5 The measured part load capacity of the second test point shall be more than the part load rating capacity point if the measured capacity of the first test is less than the part load rated capacity point.

If the unit cannot be unloaded to the 75%, 50%, or 25% load points at the minimum stage of unloading then the rating shall be determined at the minimum stage of unloading and part load rating condenser entering temperature defined in Table 12 within tolerances defined in ANSI/ASHRAE Standard 37.

Note: The actual percent load will be greater than the required percent load and will be adjusted cyclic performance using the degradation calculations as per step 3. Part load rated airflow and external static pressure, if different than full load airflow, shall be used as defined by the manufacturer and as required by Table 12.

6.2.7.2 *Step 2.* If any of the corrected rating points are within 3% of the desired IEER rating point of 75%, 50%, and 25%, they shall be used directly. If there are corrected ratings points above and below the desired IEER rating of 75%, 50%, and 25%, then the rating data the IEER rating point shall be determined using linear interpolation. If the corrected rated percent load is greater than the IEER rating for 75%, 50%, or 25% by more than 3%, then the ratings data at the condenser temperature required for the rating point shall be used along with the degradation procedure defined in Section 6.2.

6.2.7.3 *Step 3.* The rating point data from step 3 shall then be used to calculate the IEER using the procedures defined in Section 6.2.3.

6.2.8 *Example Calculations.* Appendix H contains several examples that explain the calculation of IEER and calculation of tolerances. The examples are grouped by the three rating categories defined in Section 6.2.

6.3 *Application Ratings.* Ratings at conditions of temperature or airflow rate other than those specified in Sections 6.1.3 and 6.2.1 may be published as Application Ratings, and shall be based on data determined by the methods prescribed in Section 6.5.1 or Section 6.5.2. Application Ratings in the defrost region shall include Net Capacity and COP based upon a complete defrost cycle (instantaneous capacity may be provided as long as Net Capacity is also provided).

6.3.1 *International Ratings.*

6.3.1.1 *Cooling Temperature Conditions.*

6.3.1.1.1 The T1, T2, and T3 temperature conditions specified in Table 14 shall be considered Rating Conditions for the determination of cooling capacity and energy efficiency.

6.3.1.1.2 Equipment manufactured for use only in a moderate climate similar to that specified in Column T1 of Table 14 shall have ratings at T1 conditions and shall be designated type T1 equipment.

6.3.1.1.3 Equipment manufactured for use only in a cool climate similar to that specified in Column T2 of Table 14 shall have ratings at T2 conditions and shall be designated type T2 equipment.

6.3.1.1.4 Equipment manufactured for use only in a hot climate similar to that specified in Column T3 of Table 14 shall have ratings at T3 conditions and shall be designated type T3 equipment.

6.3.1.1.5 Equipment manufactured for use in more than one of the climates defined in Table 14

shall have marked on the nameplate the designated type (T1, T2, and/or T3). The corresponding ratings shall be determined by the Rating Conditions specified in Table 14.

6.3.1.2 Heating Temperature Conditions.

6.3.1.2.1 The H1, H2, and H3 temperature conditions specified in Table 14 shall be considered Rating Conditions for the determination of heating capacity and energy efficiency.

6.3.1.2.2 All heat pumps shall be rated at the H1 temperature conditions.

6.3.1.2.3 Equipment manufactured for use in more than one of the climates defined in Table 14 shall have marked on the nameplate the designated type (H1, H2, and/or H3). The corresponding ratings shall be determined by the Rating Conditions specified in Table 14.

Table 14. Application Rating Conditions for I-P Standards¹

Cooling – Standard Temperature Conditions	T1 (Moderate Climates)	T2 (Cool Climates)	T3 (Hot Climates)
Indoor	80.6°F DB & 66.2°F WB	69.8°F DB & 59.0°F WB	84.2°F DB & 66.2°F WB
Outdoor	95.0°F DB & 75.2°F WB	80.6°F DB & 66.2°F WB	114.8°F DB & 75.2°F WB
Cooling – Maximum Temperature Conditions	T1 (Moderate Climates)	T2 (Cool Climates)	T3 (Hot Climates)
Indoor	89.6°F DB & 73.4°F WB	80.6°F DB & 66.2°F WB	89.6°F DB & 73.4°F WB
Outdoor	109.4°F DB & 78.8°F WB	95.0°F DB & 75.2°F WB	125.6°F DB & 73.4°F WB
Heating – Standard Temperature Conditions	H1 – (Warm Climates)	H2 – (Moderate Climates)	H3 – (Cold Climates)
Indoor	68.0°F DB and 59.0°F WB max.	68.0°F DB & 59.0°F WB max.	68.0°F DB and 59.0°F WB max.
Outdoor	44.6°F DB and 42.8°F WB	35.6°F DB & 33.8°F WB	19.4°F DB & 17.6°F WB
Heating – Maximum Temperature Conditions	H1 – (Warm Climates)	H2 – (Moderate Climates)	H3 – (Cold Climates)
Indoor	75.2°F DB and 64.4°F WB		
Outdoor	80.6°F DB		

Note 1: DB = dry-bulb and WB = wet-bulb.

6.4 Publication of Ratings. Wherever Application Ratings are published or printed, they shall include, or be accompanied by the Standard Ratings, plus the IEER (where applicable), shall be clearly designated as Application Ratings, including a statement of the conditions at which the ratings apply.

6.4.1 Capacity Designation. The capacity designation used in published specifications, literature or advertising, controlled by the manufacturer, for equipment rated under this standard, shall be expressed only in Btu/h at the Standard Rating Conditions specified in 6.1.3 and in the terms described in 6.1.1 and 6.1.2. Horsepower, tons or other units shall not be used as capacity designation.

6.5 Ratings. Standard Ratings for capacity, EER, IEER, SEER, HSPF or P_{w,Off} shall be based either on test data or computer simulation.

6.5.1 Note that DOE requires represented values for individual models, individual combinations, and Tested Combinations as specified in 10 CFR 429.16(a)(1). For consistency, this also applies to Standard Ratings:

6.5.1.1 Single-package Air Conditioners and Single-package Heat Pumps (Including Space-constrained). Manufacturers shall determine represented values for every individual model distributed in commerce.

6.5.1.2 Single-split Air-conditioners with Single-stage or Two-stage Compressors (Including Space-constrained and SDHV) Distributed in Commerce by an OUM. Manufacturers shall determine represented values for every individual combination distributed in commerce. For each model of Outdoor Unit, this shall include at least one Coil-only System that is representative of the least efficient combination distributed in commerce with that particular model of Outdoor Unit. Additional representations for Blower Coil Systems are allowed for any applicable individual combinations, if distributed in commerce.

6.5.1.3 *Single-split Air-conditioners with Other Than Single-stage or Two-stage Compressors (Including Space-constrained and SDHV) Distributed In Commerce By An OUM.* Manufacturers shall determine represented values for every individual combination distributed in commerce, including all Coil-only Systems and Blower Coil System.

6.5.1.4 *Single-split Heat Pumps (including space-constrained and SDHV) distributed in commerce by an OUM.* Manufacturers shall determine represented values for every individual combination distributed in commerce. If a manufacturer offers combinations of both Coil-only Systems and Blower Coil Systems, represented values shall be required for both.

6.5.1.5 *Single-split Air-Conditioners and Single-split Heat Pumps (including space-constrained and SDHV) distributed in commerce by an ICM.* Manufacturers shall determine represented values for every individual combination distributed in commerce.

6.5.1.6 *Outdoor Unit With No Match.* Manufacturers shall determine represented values for every model of Outdoor Unit distributed in commerce (tested with a model of Coil-only Indoor Unit as specified in 10 CFR 429.16(b)(2)(i)).

6.5.1.7 *Multi-split, Multi-circuit System or Multi-head Mini-split (including SDHV and space-constrained).* See section 6.5.3.3.

6.5.2 *Refrigerants.*

6.5.2.1 If a model of Outdoor Unit (used in a Single-split System, Multi-split System, Multi-circuit System, Multi-head Mini-split System, and/or Outdoor Unit with no match system) is distributed in commerce and approved for use with multiple refrigerants, a manufacturer shall determine Standard Ratings for that model using each refrigerant that can be used in an individual combination of the basic model (including Outdoor Units with no match or “Tested Combinations”). This requirement shall apply across the listed categories in the table in paragraph (a)(1) of 10 CFR 429.16. A refrigerant is considered approved for use if it is listed on the nameplate of the Outdoor Unit. If any of the refrigerants approved for use is HCFC-22 or has a 95 °F midpoint saturation absolute pressure that is ± 18% of the 95 °F saturation absolute pressure for HCFC-22, or if there are no refrigerants designated as approved for use, a manufacturer shall determine represented values (including SEER, EER, HSPF, P_{W,Off}, cooling capacity, and heating capacity, as applicable) for, at a minimum, an Outdoor Unit with no match. If a model of Outdoor Unit is not charged with a specified refrigerant from the point of manufacture or if the unit is shipped requiring the addition of more than two pounds of refrigerant to meet the charge required for the A_{Full} test per Table 8 when charged per Section 5.1.7 (unless either (a) the factory charge is equal to or greater than 70% of the Outdoor Unit internal volume times the liquid density of refrigerant at 95 °F or (b) an A2L refrigerant is approved for use and listed in the certification report), a manufacturer shall determine Standard Ratings (including SEER, EER, HSPF, P_{W,Off}, cooling capacity, and heating capacity, as applicable) for, at a minimum, an Outdoor Unit with no match.

6.5.2.2 If a model is approved for use with multiple refrigerants, Standard Ratings shall be either a) multiple Standard Ratings, with one Standard Rating provided for the performance of the model with each individual refrigerant or b) if a single Standard Rating is to be provided the least-efficient refrigerant shall be used to create the Standard Rating. A single Standard Rating made for multiple refrigerants may not include equipment in multiple categories or equipment subcategories listed in the table in paragraph 10 CFR 429.16(a)(1).

6.5.3 *Ratings Generated by Test Data.*

6.5.3.1 *Ratings Where Higher Values are Favorable.* Any capacity, EER, IEER, SEER or HSPF rating of a system generated by test data shall be based on the results of at least two unique production or production representative samples tested in accordance with all applicable portions of this standard. The capacity, EER, IEER, SEER or HSPF or ratings shall not be higher than the lower of a) the test sample mean (\bar{x}), or b) the lower 90% confidence limit (LCL) divided by 0.95 (as defined by the formulas below), rounded per Sections 6.1.1 and 6.1.2.

$$\bar{x} = \frac{\sum_{i=1}^n x_i}{n} \tag{6.11}$$

$$LCL = \bar{x} - t_{.90} \left(\frac{s}{\sqrt{n}} \right) \tag{6.12}$$

For $t_{.90}$ see Table 15 (See also Appendix A of Subpart B of 10 CFR §429).

Table 15. t Statistic	
Number of Systems Tested ¹	$t_{.90}$
2	3.078
3	1.886
4	1.638
5	1.533
6	1.476
Note 1. from Appendix A of Subpart B of 10 CFR §429	

6.5.3.2 *Ratings Where Lower Values are Favorable.* Any $P_{w,Off}$ rating, or other measure of Off-mode Power Consumption for which consumers would favor lower values, generated by test data shall be based on the results of at least two unique production or production representative samples tested in accordance with all applicable portions of this standard. The $P_{w,Off}$ ratings shall not be lower than the higher of a) the test sample mean (\bar{x}) per Equation 6.11, or b) the upper 90% confidence limit (UCL) divided by 1.05 (as defined by the formulas below), rounded per Sections 6.1.1 and 6.1.2.

$$UCL = \bar{x} + t_{.90} \left(\frac{s}{\sqrt{n}} \right) \tag{6.13}$$

6.5.3.3 *Multi-split, Multi-circuit and Multi-head Mini-split System Ratings Determined by Test.*

6.5.3.3.1 For manufacturers that offer only non-ducted combinations, ratings for each model of Outdoor Unit shall be determined by testing at least two complete system samples of the same Tested Combination of Non-ducted Indoor Units (following the sampling plan in 10 CFR 429.16).

6.5.3.3.1.1 In general, this rating applies to all combinations of a Multi-split system having the same Outdoor Unit and only Non-ducted Indoor Units, including those Non-tested Combinations (NTCs) unless a manufacturer wants to represent the rating of a specific combination.

6.5.3.3.1.2 A manufacturer shall choose to make representations for other individual combinations of models of Non-ducted Indoor Units for the same model of Outdoor Unit, but these shall be rated as separate basic models, following the sampling plan in 10 CFR 429.16.

6.5.3.3.2 Manufacturers, offering both non-ducted combinations and non-SDHV ducted combinations of Indoor Units, shall determine ratings for each model of Outdoor Unit by test according to the sampling plan in 10 CFR 429.16. Non-ducted system ratings and ducted systems ratings shall each be determined by testing two or more complete system samples of each system with all samples for each system type having the same Tested Combination.

6.5.3.3.2.1 In general, these ratings apply to all combinations of a Multi-split system having the same Outdoor Unit and using only Non-ducted Indoor Units and all combinations of a Multi-split system having the same Outdoor Unit and using only ducted Indoor Units, respectively, including those NTCs unless a manufacturer wants to represent the rating of a specific combination.

6.5.3.3.2.2 The rating given to any NTCs of Multi-split System having the same Outdoor Unit and a mix of non-ducted and ducted Indoor Units shall be set equal to the average of the ratings for the two required Tested Combinations.

6.5.3.3.2.3 A manufacturer shall choose to make representations for other individual combinations of models of Indoor Units for the same model of Outdoor Unit, but these shall be rated as separate basic models, following the sampling plan in 10 CFR 429.16

6.5.3.3.3 For manufacturers that offer SDHV combinations, ratings for each model of Outdoor Unit shall be determined by testing at least two complete system samples of the same Tested Combination of SDHV Indoor Units (following the sampling plan in 10 CFR 429.16). For Independent Coil Manufacturers, the Outdoor Unit is the least efficient model of Outdoor Unit with which the SDHV Indoor Unit shall be paired. The least efficient model of Outdoor Unit is the model of Outdoor Unit in the lowest SEER combination. If there are multiple models of Outdoor Unit with the same lowest SEER represented value, the ICM shall select one for testing purposes.

6.5.3.3.3.1 In general, this rating applies to all combinations of a Multi-split system having the same Outdoor Unit and using only SDHV Indoor Units, including those NTCs.

6.5.3.3.3.2 For basic models composed of both SDHV and non-ducted or ducted combinations, the represented value for the mixed SDHV/non-ducted or SDHV/ducted combination is the mean of the represented values for the SDHV, non-ducted, or ducted combinations, as applicable, as determined in accordance with the sampling plan in 10 CFR 429.16.

6.5.3.3.3.3 A manufacturer shall choose to make representations for other individual combinations of models of Indoor Units for the same model of Outdoor Unit, but these shall be rated as separate basic models, following the sampling plan in 10 CFR 429.16.

6.5.3.3.4 *External Static Pressure.* For Non-ducted Systems, all Indoor Units shall be subject to the same external static pressure (i.e., 0.00 in H₂O). For ducted, all Indoor Units shall be subject to the same minimum external static pressure (see Table 11) while being configurable to produce the same static pressure at the exit of each outlet plenum.

6.5.3.4 *P_{w,off}.* If individual models of Single Package Units or individual combinations (or “Tested Combinations”) of Split System that are otherwise identical are offered with multiple options for off-mode-related components, determine the represented value for the individual model/combination with the Crankcase Heater and controls that are the most consumptive. A manufacturer may also determine represented values for individual models/combinations with less consumptive off-mode options; however, all such options shall be identified with different model numbers for single-package systems or for Outdoor Units (in the case of Split Systems).

6.5.4 *Ratings Generated by Computer Simulation.* Any capacity, EER, IEER, SEER or HSPF rating of a system generated by the results of an Alternative Efficiency Determination Method (AEDM) shall be no higher than the result of the AEDM (after rounding per Sections 6.1.1 and 6.1.2). Any P_{w,off} rating of a system generated by the results of an AEDM shall be no lower than or equal to the output of the AEDM. Any AEDM used shall be created in compliance with the regulations specified in 10 CFR §429.70.

6.5.4.1 No model of OUWNM shall be rated by computer simulation. All models of OUWNM shall be rated by test.

6.5.5 *Documentation.* As required by federal law (10 CFR §429.71), supporting documentation of all Published Ratings subject to federal control shall be appropriately maintained.

6.5.6 *Multiple Standard Ratings.* A single product may have more than one Standard Rating. If multiple Standard Ratings exist, the conditions for each Standard Rating shall be clearly identified for each individual Standard Rating (e.g. A Two-capacity Heat Pump may be rated as a Two-Capacity Northern Heat Pump by locking out high stage cooling).

6.6 *Uncertainty.* When testing a sample unit, there are uncertainties that shall be considered. All tests shall be conducted in a laboratory that meets the requirements referenced in this standard, ANSI/ASHRAE Standard 37 and ANSI/ASHRAE Standard 116. The uncertainty for Standard Ratings covered by this standard include the following.

6.6.1 *Uncertainty of Measurement.* When testing a unit, there are variations that result from instrumentation and laboratory constructed subsystems for measurements of temperatures, pressure, power, and flow rates.

6.6.2 *Uncertainty of Test Rooms.* The same unit tested in multiple rooms may not yield the same performance due to setup variations and product handling.

6.6.3 *Variability due to Manufacturing.* During the manufacturing of units, there are variations due to manufacturing production tolerances that will impact the performance of the unit.

6.6.4 *Uncertainty of Performance Simulation Tools.* Due to the large complexity of options, manufacturers may use performance prediction tools like an AEDM.

6.6.5 *Variability due to Environmental Conditions.* Changes to ambient conditions such as inlet temperature conditions and barometric pressure can alter the measured performance of the unit.

6.6.6 *Variability of System Under Test.* The system under test instability may not yield repeatable results.

Section 7. Minimum Data Requirements for Published Ratings

7.1 *Minimum Data Requirements for Published Ratings.* As a minimum, Published Ratings shall include all Standard Ratings shown below:

7.1.1 For Unitary Air-conditioners (air-cooled)

7.1.1.1 AHRI Standard Rating cooling capacity, Btu/h

7.1.1.2 Energy Efficiency Ratio (EER_{A,Full}), Btu/(W·h)

7.1.1.3 Seasonal Energy Efficiency Ratio (SEER), Btu/(W·h)

7.1.2 For Unitary Air-conditioners (Water-cooled and Evaporatively-cooled Air-conditioners)

7.1.2.1 AHRI Standard Rating cooling capacity, Btu/h

7.1.2.2 Energy Efficiency Ratio (EER), Btu/(W·h)

7.1.2.3 Integrated Energy Efficiency Ratio (IEER), Btu/(W·h)

7.1.3 For all Unitary Air-source Heat Pumps

7.1.3.1 AHRI standard rating cooling capacity, Btu/h

7.1.3.2 Energy Efficiency Ratio (EER_{A,Full}), Btu/(W·h)

7.1.3.3 Seasonal Energy Efficiency Ratio (SEER), Btu/(W·h)

7.1.3.4 High temperature heating Standard Rating capacity, Btu/h

7.1.3.5 Region IV Heating Seasonal Performance Factor, HSPF, using minimum Design Heating Requirement, Btu/(W·h)

7.2 For Split Systems, Standard Ratings shall be published for every refrigerant listed as permissible for use on the nameplate of the Outdoor Unit. If multiple refrigerants are listed as permissible for use on the nameplate of the Outdoor Unit and a single Standard Rating is applied for all refrigerants, a statement shall be included noting the single Standard Rating applies for all refrigerants.

7.3 *Latent Cooling Capacity Designation.* The Latent Cooling Capacity used in published specifications, literature or advertising, controlled by the manufacturer, for equipment rated under this standard, total or Sensible Cooling Capacity shall be expressed consistently in either Gross Capacity or Net Capacity in one or more of the following forms:

7.3.1 Sensible Cooling Capacity / total Net Capacity ratio and total Net Capacity

7.3.2 Latent Cooling Capacity and total Net Capacity

7.3.3 Sensible Cooling Capacity and total Net Capacity

7.4 All claims to ratings within the scope of this standard shall include the statement “Rated in accordance with AHRI Standard 210/240.” All claims to ratings outside the scope of this standard shall include the statement “Outside the scope of AHRI Standard 210/240.” Wherever Application Ratings are published or printed, they shall include a statement of the conditions at which the ratings apply.

Section 8. Operating Requirements

8.1 *Operating Requirements.* Unitary equipment shall comply with the provisions of this section such that any production unit shall meet the requirements detailed herein.

8.2 *Maximum Operating Conditions Test.* Unitary equipment shall pass the following maximum operating conditions test with indoor-coil airflow rate $\dot{Q}_{A,Full}$ as determined under Section 6.1.5.

8.2.1 *Temperature Conditions.* Temperature conditions shall be maintained as shown in Table 8 or Table 9, as applicable, in accordance with the unit's nameplate. For equipment marked for application for more than one Standard Rating condition the most stringent outdoor ambient conditions shall be used.

8.2.2 *Voltages.* The test shall be run at the Range A minimum utilization voltage from AHRI Standard 110, Table 1, based upon the unit's nameplate rated voltage(s). This voltage shall be supplied at the unit's service connection and at rated frequency. A lower minimum voltage shall be used, if listed on the nameplate.

8.2.3 *Procedure.* The equipment shall be operated for one hour at the temperature conditions and voltage specified.

8.2.4 *Requirements.* The equipment shall operate continuously without interruption for any reason for one hour.

8.2.4.1 Units with water-cooled condensers shall be capable of operation under these maximum conditions at a water- pressure drop not to exceed 15.0 psi, measured across the unit.

8.3 *Voltage Tolerance Test.* Unitary equipment shall pass the following voltage tolerance test with a cooling coil airflow rate as determined under Section 6.1.5.

8.3.1 *Temperature Conditions.* Temperature conditions shall be maintained at the standard cooling (and/or standard heating, as required) steady state conditions as shown in Table 8 or Table 9, as applicable, in accordance with the unit's nameplate. For equipment marked for applications for more than one Standard Rating condition (T1, T2, and/or T3) the most stringent outdoor ambient conditions shall be used.

8.3.2 *Voltages.*

8.3.2.1 *Steady State.* Two separate tests shall be performed, one test at the Range B minimum utilization voltage and one test at the Range B maximum utilization voltage from AHRI Standard 110, Table 1, based upon the unit's nameplate rated voltage(s). These voltages shall be supplied at the unit's service connection and at rated frequency. A lower minimum or a higher maximum voltage shall be used, if listed on the nameplate.

8.3.2.2 *Power Interrupt.* During the power interrupt portion of each test, the voltage supplied to the equipment (single phase and three phase) shall be adjusted just prior to the shut-down period (Section 8.3.3.2) such that the resulting voltage at the unit's service connection is 86% of nameplate rated voltage when the compressor motor is on locked-rotor. (For 200 V or 208 V nameplate rated equipment the restart voltage shall be set at 180 V when the compressor motor is on locked rotor). Open circuit voltage for three phase equipment shall not be greater than 90% of nameplate rated voltage.

8.3.2.3 *Resume Operation.* During the resume operation portion of the test, the voltage supplied to the equipment shall be the same as the voltage as per Section 8.3.2.1.

8.3.3 *Procedure.*

8.3.3.1 *Steady State.* The equipment shall be operated for one hour at the temperature conditions and each voltage specified in Sections 8.3.1 and 8.3.2.

8.3.3.2 *Power Interrupt.* All power to the equipment shall be shut off for a period sufficient to cause the compressor to stop (not to exceed five seconds) and then immediately restored.

8.3.3.3 *Resume Operation.* Within one minute after the equipment has resumed continuous operation (Section 8.3.4.3), the voltage shall be restored to the values specified in Section 8.3.2.1. During the remainder

of resume operations phase, voltage and temperature conditions shall be retained as specified in Section 8.3.3.1. Refer to Figure 2.

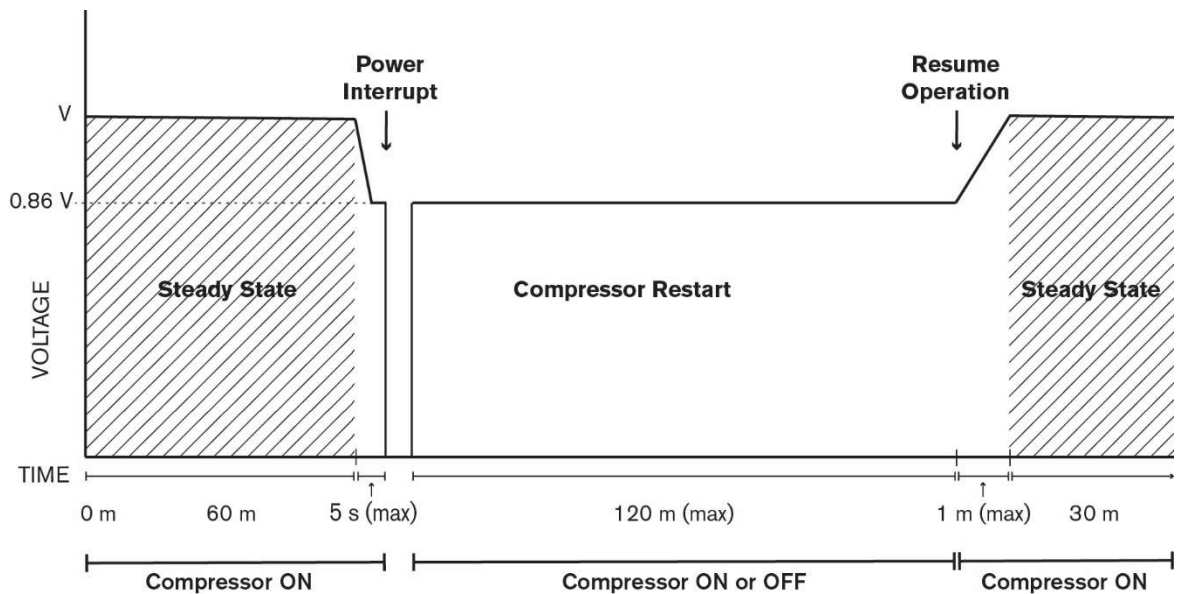

Figure 2. Voltage Tolerance Test Power Interrupt Procedure.

8.3.4 Requirements.

8.3.4.1 During the entire test, the equipment shall operate without damage or failure of any of its parts.

8.3.4.2 Steady State - During the steady state portion of the test, the equipment shall operate continuously without interruption for any reason.

8.3.4.3 Resume Operation - During the resume operation portion of the test, the unit shall resume continuous operation within two hours of restoration of power and shall then operate continuously for one half hour. Operation and automatic resetting of safety devices prior to re-establishment of continuous operation is permitted.

8.4 Low-Temperature Operation Test (Cooling) (Not Required For Heating-only Units). Unitary equipment shall pass the following low-temperature operation test when operating with initial airflow rate, $\dot{Q}_{A,Full}$, as determined in Section 6.1.5 and with controls and dampers set to produce the maximum tendency to frost or ice the evaporator, provided such settings are not contrary to the manufacturer's instructions to the user.

8.4.1 Temperature Conditions. Temperature Conditions shall be maintained as shown in Table 8 or Table 9.

8.4.2 Procedure. The test shall be continuous with the unit on the cooling cycle, for not less than four hours after establishment of the specified temperature conditions. The unit shall be permitted to start and stop under control of an automatic limit device, if provided.

8.4.3 Requirements.

8.4.3.1 During the entire test, the equipment shall operate without damage or failure of any of its parts.

8.4.3.2 During the entire test, the saturated evaporating temperature shall not be less than 32 °F + half of refrigerant temperature glide.

8.4.3.3 During the test and during the defrosting period after the completion of the test, all ice or meltage shall be caught and removed by the drain provisions.

8.5 Insulation Effectiveness Test (Cooling) (not required for heating-only units). Unitary equipment shall pass the following insulation effectiveness test when operating with airflow rate, $\dot{Q}_{A,Full}$, as determined in Sections 6.1.5 and 6.1.6 with controls,

fans, dampers, and grilles set to produce the maximum tendency to sweat, provided such settings are not contrary to the manufacturer's instructions to the user.

8.5.1 *Temperature Conditions.* Temperature conditions shall be maintained as shown in Table 8 or Table 9.

8.5.2 *Procedure.* After establishment of the specified temperature conditions, the unit shall be operated continuously for a period of four hours.

8.5.3 *Requirements.* During the test, no condensed water shall drop, run, or blow off from the unit casing.

8.6 *Condensate Disposal Test (Cooling)* (not required for heating-only units).* Unitary equipment which rejects condensate to the condenser air shall pass the following condensate disposal test when operating with airflow rates as determined in Section 6.1.5 and with controls and dampers set to produce condensate at the maximum rate, provided such settings are not contrary to the manufacturer's instructions to the user.

* This test may be run concurrently with the Insulation Effectiveness Test (Section 8.5).

8.6.1 *Temperature Conditions.* Temperature conditions shall be maintained as shown in Table 8 or Table 9.

8.6.2 *Procedure.* After establishment of the specified temperature conditions, the equipment shall be started with its condensate collection pan filled to the overflowing point and shall be operated continuously for four hours after the condensate level has reached equilibrium.

8.6.3 *Requirements.* During the test, there shall be no dripping, running-off, or blowing-off of moisture from the unit casing.

8.7 *Tolerances.* The room ambient conditions for the tests outlined in Section 8 are average values subject to tolerances of ± 1.0 °F for air wet-bulb and dry-bulb temperatures and $\pm 1.0\%$ of the reading for voltages.

Section 9. Marking and Nameplate Data

9.1 *Marking and Nameplate Data.* As a minimum, the nameplate shall display the manufacturer's name, model designation, electrical characteristics and refrigerants approved for use by the manufacturer.

Nameplate voltages for 60 Hz systems shall include one or more of the equipment nameplate voltage ratings shown in Table 1 of AHRI Standard 110. Nameplate voltages for 50 Hz systems shall include one or more of the utilization voltages shown in Table 1 of IEC Standard 60038.

Section 10. Conformance Conditions

10.1 *Conformance.* While conformance with this standard is voluntary, conformance shall not be claimed or implied for products or equipment within the standard's *Purpose* (Section 1) and *Scope* (Section 2) unless such product claims meet all of the requirements of the standard and all of the testing and rating requirements are measured and reported in complete compliance with the standard. Any product that has not met all the requirements of the standard shall not reference, state, or acknowledge the standard in any written, oral, or electronic communication.

10.2 *Verification Testing Criteria.* To comply with this standard, single sample production verification tests shall meet the certified Standard Rating performance metrics shown in Table J1 with the listed acceptance criteria.

Section 11. Calculations

All steady state capacity calculations in this standard are in principle the same as the capacity calculations in ANSI/ASHRAE Standard 37. In this standard the capacity subscripts are included for the individual tests. Seasonal efficiency calculations in this standard are in principle the same as the seasonal efficiency calculations in ANSI/ASHRAE Standard 116, except that they use the subscripted capacity nomenclature. The calculations in this standard shall take precedence over ASHRAE calculations.

Indoor air enthalpy method shall be the primary calculation used to determine system capacity. Outdoor enthalpy or refrigerant enthalpy method shall only be used for secondary calculation methods.

11.1 Individual Test Calculations. For this section subscript lowercase “x” is used for the individual test measurement. For example, the symbol for Total Cooling Capacity for the A_{Full} test is $q_{tci,A,Full}$, in this calculation section q_x is used, where “x” is equal to A_{Full}. For all capacities calculated in Section 11, round the calculated value to the nearest integer. For all Degradation Coefficients, round the calculated value to the nearest 0.01. If the calculated Degradation Coefficient is negative, set the Degradation Coefficient equal to zero.

For all Steady State Tests and for frost accumulation (H2 tests), air volume rate through the indoor coil, \dot{Q}_{mi} , and air volume rate through the Outdoor Coil, \dot{Q}_{mo} , shall be calculated per the equations specified in Sections 7.7.2.1 and 7.7.2.2 of ANSI/ASHRAE Standard 37. The standard airflow rate, \dot{Q}_s , shall be calculated from Section 7.7.2.3 of ANSI/ASHRAE Standard 37.

11.1.1 Cooling Steady State Net-Total Capacity.

11.1.1.1 Total Cooling Capacity (Indoor Air Enthalpy Method). The Net total Capacity for all steady state cooling tests shall be calculated using Equation 11.2 for Blower Coil Systems or using Equation 11.3 for Coil-only Systems.

$$\dot{q}_x = \frac{60 \cdot \dot{Q}_{mi}(h_{a1} - h_{a2})}{v'_n(1+W_n)} \quad 11.1$$

$$\dot{q}_{tci,x} = \dot{q}_x + \dot{q}_{duct,ci} \quad 11.2$$

$$\dot{q}_{tci,x} = \dot{q}_x + \dot{q}_{duct,ci} - \dot{q}_{sadj,x} \quad 11.3$$

Where Equation 11.4 shall be used when the Indoor Unit is in the indoor psychrometric chamber, Equation 11.5 shall be used when the indoor section is completely in the outdoor chamber. Equation 11.6 is shown for reference. Duct loss, $\dot{q}_{duct,ci}$, shall be set to 0 for steady state tests C and G.

$$\dot{q}_{duct,ci} = UA_{ID,si}(t_{a1} - t_{a2}) \quad 11.4$$

$$\dot{q}_{duct,ci} = UA_{ID,ro}(t_{a0} - t_{a1}) + UA_{ID,so}(t_{a0} - t_{a2}) + UA_{ID,si}(t_{a1} - t_{a2}) \quad 11.5$$

$$v'_n(1 + W_n) = v_n \quad 11.6$$

11.1.1.2 Total Cooling Capacity (Outdoor Air Enthalpy Method). The Net total Capacity for all steady state cooling tests shall be calculated using Equation 11.7 for units that do re-evaporate drained condensate from the indoor coil or Equation 11.8 for units that do not re-evaporate drained condensate from the indoor coil.

$$\dot{q}_{tco,x} = \frac{60 \cdot \dot{Q}_{mo}(h_{a4} - h_{a3})}{v'_n(1+W_n)} - 3.412 \cdot P_{tot,x} \quad 11.7$$

$$\dot{q}_{tco,x} = \frac{60 \cdot \dot{Q}_{mo}c_{pa4}(t_{a4} - t_{a3})}{v'_n(1+W_n)} - 3.412 \cdot P_{tot,x} \quad 11.8$$

11.1.1.3 Total Cooling Capacity (Refrigerant Enthalpy Method). The Net total Capacity for all steady state cooling tests shall be calculated as follows. See Section D6.3.2 of this Standard for information about mass flow ratio, x.

$$\dot{q}_{ref,x} = x\dot{m}_{ref,x}(h_{r2} - h_{r1}) - \dot{q}_{sadj,x} \quad 11.9$$

11.1.1.4 Indoor motor heat capacity adjustment, \dot{q}_{sadj} .

For Coil-only Systems:

$$\dot{q}s_{adj,x} = \frac{1250}{1000} \cdot \dot{Q}_s \quad 11.10$$

Where 1250 Btu/h is the heat generated from default blower power per 1000 scfm.

For all Blower Coil Systems:

$$\dot{q}s_{adj,x} = 3.412 \cdot P_{fan,x} \quad 11.11$$

11.1.1.5 Heat Balance. If using the outdoor enthalpy as an alternate method, use Equation 11.12, or if using refrigerant enthalpy as an alternate method, use Equation 11.13.

$$HB_x = \frac{\dot{q}_{tci,x} - \dot{q}_{tco,x}}{\dot{q}_{tci,x}} \quad 11.12$$

$$HB_x = \frac{\dot{q}_{tci,x} - \dot{q}_{ref,x}}{\dot{q}_{tci,x}} \quad 11.13$$

11.1.2 Cooling Steady State Power. The steady state power, $P_{tot,x}$, shall be as measured during test, adjusted as follows, using Equation 11.14 for Blower Coil Systems or using Equation 11.15 for Coil-only Systems.

$$P_{tot,x} = P_{m,x} + P_{adj} \quad 11.14$$

$$P_{tot,x} = P_{m,x} + PS_{adj,x} \quad 11.15$$

Where:

$$PS_{adj,x} = \frac{365}{1000} \cdot \dot{Q}_s \quad 11.16$$

Where 365 watts is a default power consumption per 1000 scfm, and P_{adj} only applies for Constant-volume AMS per Section 6.1.5.1.3 (P_{adj} is 0 for all other Blower Coil Systems).

11.1.3 Cooling Steady State Efficiency, EER. The steady state efficiency shall be calculated as follows.

$$EER_x = \frac{\dot{q}_{tci,x}}{P_{tot,x}} \quad 11.17$$

11.1.4 Cooling Cyclic Net Total Capacity. The Net total Capacity for all cyclic cooling tests (tests D and I) shall be calculated as follows. \dot{Q}_{mi} , c_{pa} , v'_n , $P_{fan,x}$, and W_n shall be the average values recorded during the corresponding dry coil steady state tests (tests C and G).

$$q'_{cyc,x} = \frac{60 \cdot \dot{Q}_{mi} c_{pa} \Gamma}{v'_n (1 + W_n)} - q_{cadj,x} \quad 11.18$$

Where:

$$\Gamma = F_{CD}^* \int_{\theta_1}^{\theta_2} [t_{a1}(\theta) - t_{a2}(\theta)] d\theta \quad 11.19$$

Where F_{CD}^* is calculated per Section 5.2.3.3 using values measured during C & D tests.

For Coil-only Systems:

$$qc_{adj,x} = \frac{1250}{1000} \cdot \dot{Q}_s [\theta_2 - \theta_1] \quad 11.20$$

For Blower Coil Systems with Constant-volume AMS or Constant-torque AMS which has the blower disabled for Cyclic Test:

$$qc_{adj,x} = 3.412 \cdot P_{fan,x} \cdot [\theta_2 - \theta_1] \quad 11.21$$

For all other Blower Coil Systems:

$$qc_{adj,x} = 0 \quad 11.22$$

For all other Non-ducted Systems:

$$qc_{adj,x} = 3.412 \cdot E_{fan,x} \quad 11.23$$

For Non-ducted Systems, subtract the electrical energy used by the indoor fan, E_{fan} , during the 3 minutes after compressor cutoff from the Non-ducted System's integrated cooling capacity, $q'_{cyc,x}$.

11.1.5 Cooling Cyclic Energy. The energy used during Cyclic Tests, $E_{tot,x}$, shall be as measured during test, adjusted as follows, using Equation 11.24 for Blower Coil Systems (except Blower Coil Systems with variable speed blower Constant-volume AMS or Constant-torque AMS which has the blower disabled for Cyclic Test) or using Equation 11.25 for Coil-only Systems and for Blower Coil Systems with Constant-volume AMS or Constant-torque AMS which has the blower disabled for Cyclic Test.

$$E_{cyc,x} = E_{m,x} \quad 11.24$$

$$E_{cyc,x} = E_{m,x} + E_{cadj,x} \quad 11.25$$

Where for Blower Coil Systems with Constant-volume AMS or Constant-torque AMS which has the blower disabled for Cyclic Test $E_{cadj,x}$ is calculated per Equation F1 and for Coil-only System $E_{cadj,x}$ is calculated per Equation 11.26.

$$E_{cadj,x} = \frac{365}{1000} \cdot \dot{Q}_s \cdot [\theta_2 - \theta_1] \quad 11.26$$

11.1.6 Cooling Cyclic Efficiency, EER. The cyclic efficiency shall be calculated as follows.

$$EER_x = \frac{q'_{cyc,x}}{E_{cyc,x}} \quad 11.27$$

11.1.7 Heating Steady State Net ~~Total~~ Capacity.

11.1.7.1 Total Heating Capacity (Indoor Air Enthalpy Method). The total Net Capacity, $\dot{q}_{thi,x}$, for all steady state heating tests shall be calculated using Equation 11.28 for Blower Coil Systems or using Equation 11.29 Coil-only Systems. For the purpose of calculation of degradation coefficient, C_D^h , duct loss shall not be considered, therefore capacity without duct loss, $\dot{q}'_{thi,x}$, shall be calculated using Equation 11.30 for Blower Coil Systems or using Equation 11.31 Coil-only Systems.

$$\dot{q}_{thi,x} = \frac{60 \cdot \dot{Q}_{mi} c_{paz} (t_{a2} - t_{a1})}{v'_n (1 + W_n)} + q_{duct,hi} \quad 11.28$$

$$\dot{q}_{thi,x} = \frac{60 \cdot \dot{Q}_{mi} c_{pa2} (t_{a2} - t_{a1})}{v'_n (1 + W_n)} + q_{duct,hi} + \dot{q}_{sadj,x} \quad 11.29$$

$$\dot{q}'_{thi,x} = \frac{60 \cdot \dot{Q}_{mi} c_{pa2} (t_{a2} - t_{a1})}{v'_n (1 + W_n)} \quad 11.30$$

$$\dot{q}'_{thi,x} = \frac{60 \cdot \dot{Q}_{mi} c_{pa2} (t_{a2} - t_{a1})}{v'_n (1 + W_n)} + \dot{q}_{sadj,x} \quad 11.31$$

Where:

$$c_{pa2} = 0.24 + 0.444W_n \quad 11.32$$

and where Equation 11.33 shall be used when the Indoor Unit is in the indoor psychrometric chamber, Equation 11.34 shall be used when the indoor section is completely in the outdoor chamber.

$$\dot{q}_{duct,hi} = UA_{ID,si} (t_{a2} - t_{a1}) \quad 11.33$$

$$\dot{q}_{duct,hi} = UA_{ID,ro} (t_{a1} - t_{a0}) + UA_{ID,so} (t_{a2} - t_{a0}) + UA_{ID,si} (t_{a2} - t_{a1}) \quad 11.34$$

For the heating mode Equation 11.35 applies.

$$W_n = W_1 = W_2 \quad 11.35$$

For only test H2_x, in lieu of conducting the test, the capacity shall be calculated per Equation 11.36, where $\dot{q}_{thi,H1_x}$ and $\dot{q}_{thi,H3_x}$ are determined by test. *x* may be either Full or Low.

$$\dot{q}_{thi,H2_x} = 0.90 \cdot \{ \dot{q}_{thi,H3_x} + 0.6 \cdot (\dot{q}_{thi,H1_x} - \dot{q}_{thi,H3_x}) \} \quad 11.36$$

11.1.7.2 Total Heating Capacity (Outdoor Air Enthalpy Method). The ~~Net total~~ Capacity for all steady state heating tests shall be calculated as follows.

$$\dot{q}_{tho,x} = \frac{60 \cdot \dot{Q}_{mo} (h_{a3} - h_{a4})}{v'_n (1 + W_n)} + 3.412 \cdot P_{tot,x} \quad 11.37$$

where for Equation 11.6

$$W_n = W_4 \quad 11.38$$

11.1.7.3 Total Heating Capacity (Refrigerant Enthalpy Method). The ~~Net total~~ Capacity for all steady state heating tests shall be calculated as follows.

$$\dot{q}_{ref,x} = x \dot{m}_{ref,x} (h_{r1} - h_{r2}) + \dot{q}_{sadj,x} \quad 11.39$$

11.1.8 Heating Steady State Power. The steady state power, $P_{tot,x}$, shall be as measured during test, adjusted as follows, using Equation 11.40 for Blower Coil Systems or using Equation 11.41 for Coil-only Systems.

$$P_{tot,x} = P_{m,x} + P_{adj} \quad 11.40$$

$$P_{tot,x} = P_{m,x} + P_{sadj,x} \quad 11.41$$

P_{adj} only applies for Constant-volume AMS per Section 6.1.5.1.3. For only test H2_x, in lieu of conducting the test, the power shall be calculated per Equation 11.42, where P_{H1_x} and P_{H3_x} are determined by test.

$$P_{H2_x} = 0.985 \cdot \{P_{H3_x} + 0.6 \cdot (P_{H1_x} - P_{H3_x})\} \quad 11.42$$

11.1.9 Heating Steady State Efficiency, COP. The steady state efficiency shall be calculated as follows.

$$COP_x = \frac{\dot{q}_{thi,x}}{3.412 \cdot P_{tot,x}} \quad 11.43$$

11.1.10 Heating Cyclic Net Total Capacity. The Net total Capacity for all cyclic heating tests shall be calculated using Equation 11.39. Q_{mi} , c_{pa} , v'_n , and W_n shall be the values recorded during the corresponding steady state tests.

$$q'_{cyc,x} = \frac{60 \cdot \dot{Q}_{mi} c_{pa} \Gamma}{v'_n (1+W_n)} + qC_{adj,x} \quad 11.44$$

Where:

$$\Gamma = F_{CD}^* \int_{\theta_1}^{\theta_2} [t_{a2}(\theta) - t_{a1}(\theta)] d\theta \quad 11.45$$

Where F_{CD}^* is calculated per Section 5.2.3.3 using values measured during H1 & H1C tests.

To determine $qC_{adj,x}$, for Coil-only Systems, see Equation 11.20. For Blower Coil Systems with Constant-volume AMS which has the blower disabled for Cyclic Test, see Equation 11.21. For all Blower Coil Systems, see Equation 11.22. For all other Non-ducted Systems, see Equation 11.23. For Non-ducted Heat Pumps, subtract the electrical energy used by the indoor fan, $E_{fan,x}$, during the 3 minutes after compressor cutoff from the Non-ducted Heat Pump's integrated heating capacity, $q_{eyc,x}$.

11.1.11 Heating Cyclic Energy. The energy used during heating Cyclic Tests, $E_{cyc,x}$, shall be as measured during test, adjusted using Equations 11.24 to 11.26.

11.1.12 Heating Cyclic Efficiency, COP. The cyclic efficiency shall be calculated as follows.

$$COP_{cyc,x} = \frac{q'_{cyc,x}}{3.412 \cdot E_{cyc,x}} \quad 11.46$$

11.1.13 Heating Frost Accumulation. The heating capacity for all frost accumulation tests shall be calculated as follows. Values in Equation 11.47 are averages from the defrost termination to defrost termination, unless otherwise specified.

$$q_{def,x} = \frac{60 \cdot \dot{Q}_{mi} \cdot c_{pa} \cdot \Gamma_{ON}}{v'_n \cdot (1+W_n)} + qC_{adj,x} \quad 11.47$$

where $qC_{adj,x}$ is calculated per Equations 11.20 to 11.23, as appropriate, and where

$$\Gamma_{ON} = \int_{\theta_3}^{\theta_4} [t_{a2}(\theta) - t_{a1}(\theta)] d\theta \quad 11.48$$

$$\dot{q}_{def,x} = \frac{q_{def,x}}{\theta_4 - \theta_3} \quad 11.49$$

11.1.14 Defrost Energy and Power. The energy, $E_{def,x}$, and power, $P_{def,x}$, used during defrost tests shall be as measured during test, adjusted as follows, using Equation 11.50 for Blower Coil Systems or using Equation 11.51 for Coil-only Systems.

$$E_{def,x} = E_{m,x} \quad 11.50$$

$$E_{def,x} = E_{m,x} + E_{cadj,x} \quad 11.51$$

Where:

$$E_{cadj,x} = \frac{365}{1000} \cdot \dot{Q}_s \cdot [\theta_4 - \theta_3] \quad 11.52$$

$$P_{def,x} = \frac{E_{def,x}}{\theta_4 - \theta_3} + P_{adj} \quad 11.53$$

Where P_{adj} only applies for Constant-volume AMS per Section 6.1.5.1.3.

11.1.15 Heating Frost Accumulation Efficiency, COP.

$$COP_{def,x} = \frac{\dot{q}_{def,x}}{3.412 \cdot P_{def,x}} \quad 11.54$$

11.2 Seasonal Efficiency Calculations. Seasonal efficiency descriptors, SEER, HSPF, shall be calculated per the equations in this section, using the results from the individual test calculations from Section 11.1. Throughout the seasonal efficiency calculations wherever the values 95, 82, 67, 62, 47, 35, and 17 °F are used, they are derived from the outdoor dry bulb temperatures, °F, at test conditions A, B, F, H0, H1, H2, and H3, respectively.

11.2.1 SEER.

11.2.1.1 Single Stage System. SEER for a Single Stage System shall be calculated as follows.

$$SEER = PLF(0.5) \cdot EER_{B,Full} \quad 11.55$$

Where:

$$PLF(0.5) = 1 - 0.5 \cdot C_D^{c,Full} \quad 11.56$$

$$C_D^{c,Full} = \frac{\left\{1 - \frac{EER_{D,Full}}{EER_{C,Full}}\right\}}{1 - CLF^{cyc,Full}} \quad 11.57$$

$$CLF^{cyc,Full} = \frac{q'_{cyc,D,Full}}{(\dot{q}_{C,Full} \cdot \theta_{cyc})} \quad 11.58$$

If the optional Tests C and D (refer to Table 7) are not performed, or the calculated result for $C_D^{c,Full}$ is greater than the default value of Section 6.1.3.1, the default value shall be used. See Figure 3 for a graphical representation of SEER.

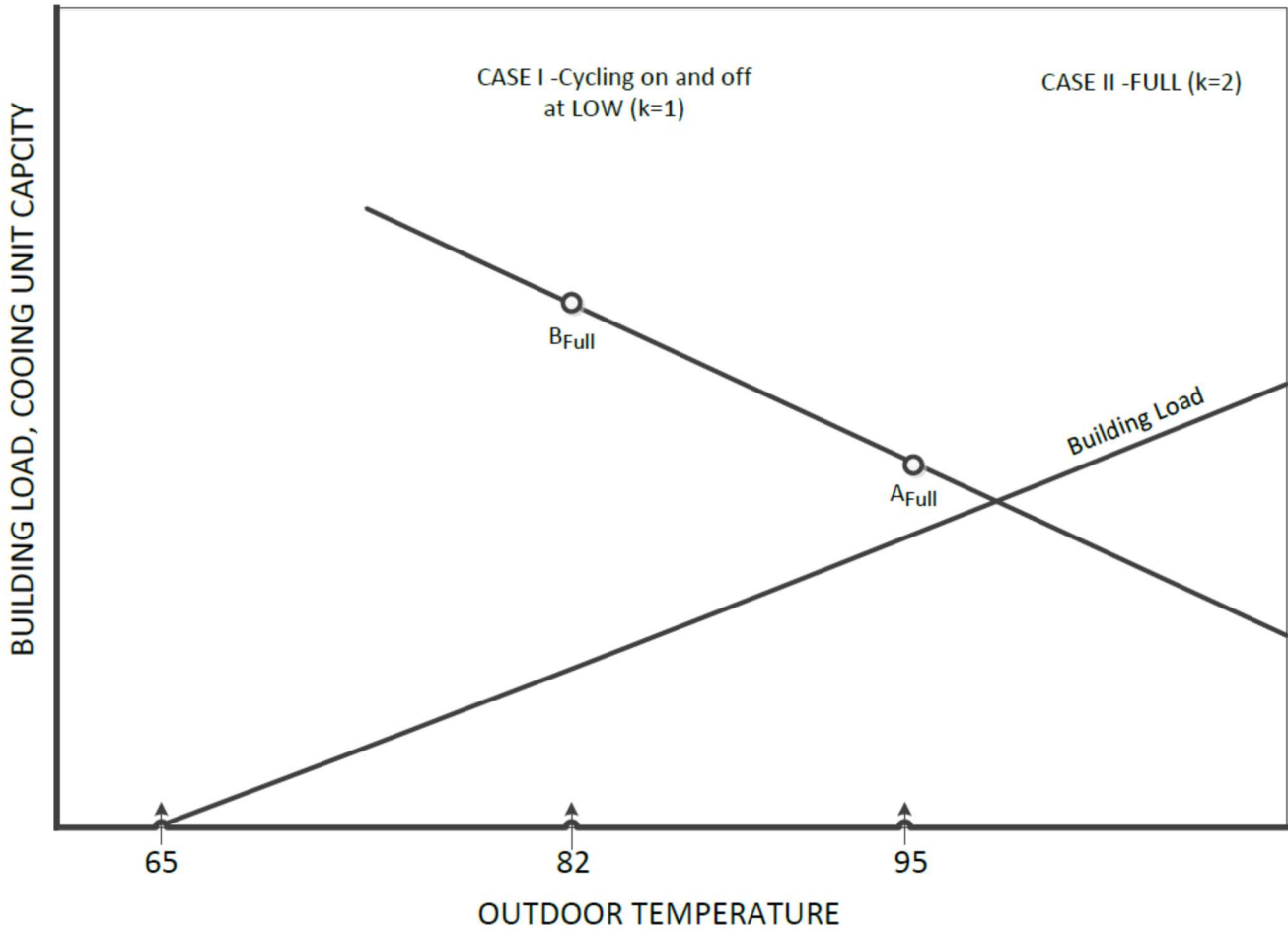

Figure 3. Schematic of a Single-speed System Operation in the Cooling Mode (See Tables 8 and 9 for Temperature References)

11.2.1.2 Two-stage System. SEER for a Two-stage System shall be calculated as follows.

$$SEER = \frac{\sum_{j=1}^8 q(t_j)}{\sum_{j=1}^8 E(t_j)} \tag{11.59}$$

The quantities $q(t_j)$ and $E(t_j)$ are calculated for each individual Temperature Bin using the appropriate formula for each bin depending on the operating characteristics of the system. Bin temperatures and bin hours shall be realized from Table 16. When the building load is less than low stage capacity use Section 11.2.1.2.1. When the building load is greater than the low stage capacity, but less than the high stage capacity, either Section 11.2.1.2.2 or is used, depending on the operating characteristics of the system.

Bin Number (j)	Bin Temperature (t _j), °F	Fractional Bin Hours (n _j)
1	67	0.214
2	72	0.231
3	77	0.216
4	82	0.161
5	87	0.104
6	92	0.052
7	97	0.018
8	102	0.004

When the building load is greater than the unit capacity use Section 11.2.1.2.4. Geographical map showing cooling load hours is shown in Figure 4. See Figure 5 for a graphical representation.

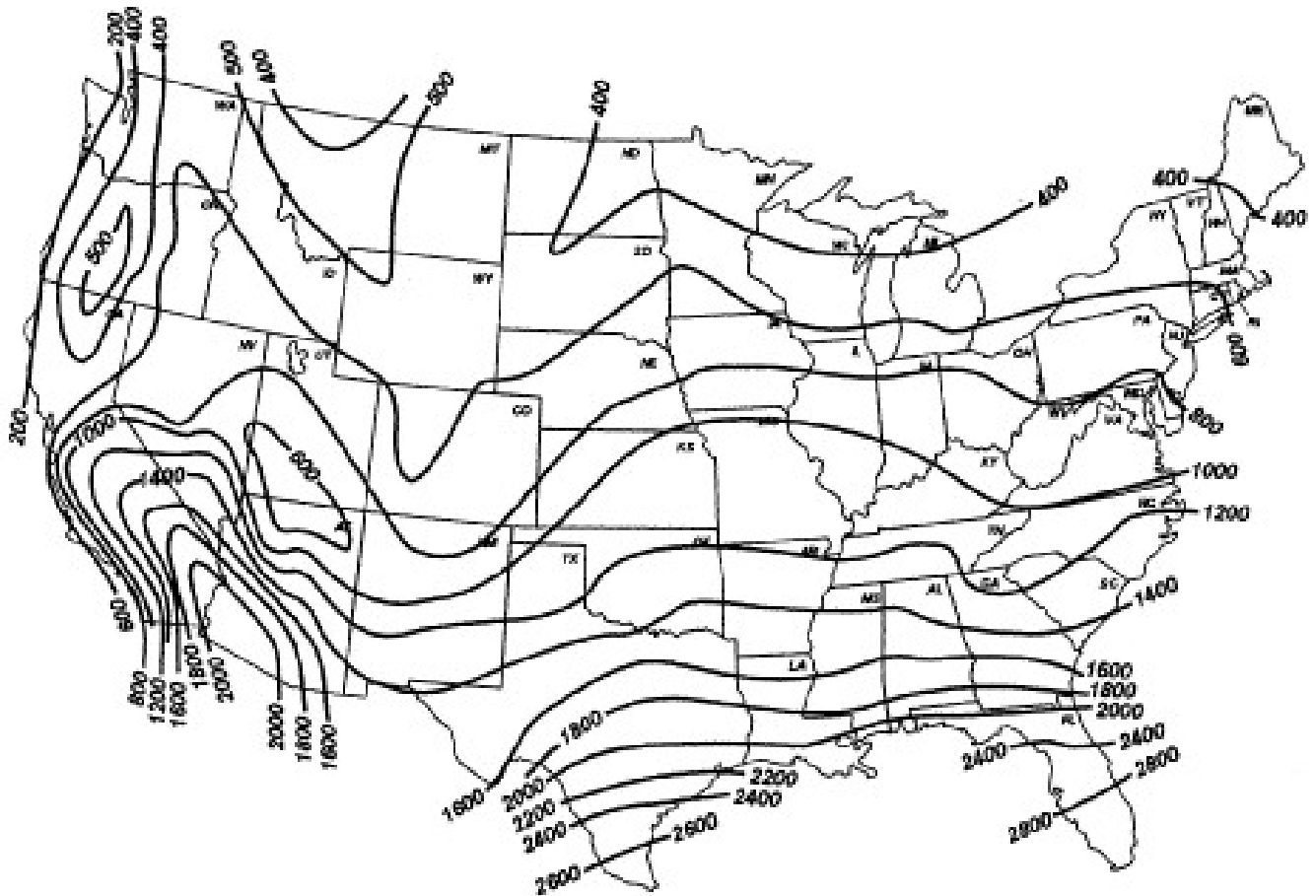

Figure 4. Cooling Load Hours (CLH_A) for the United States

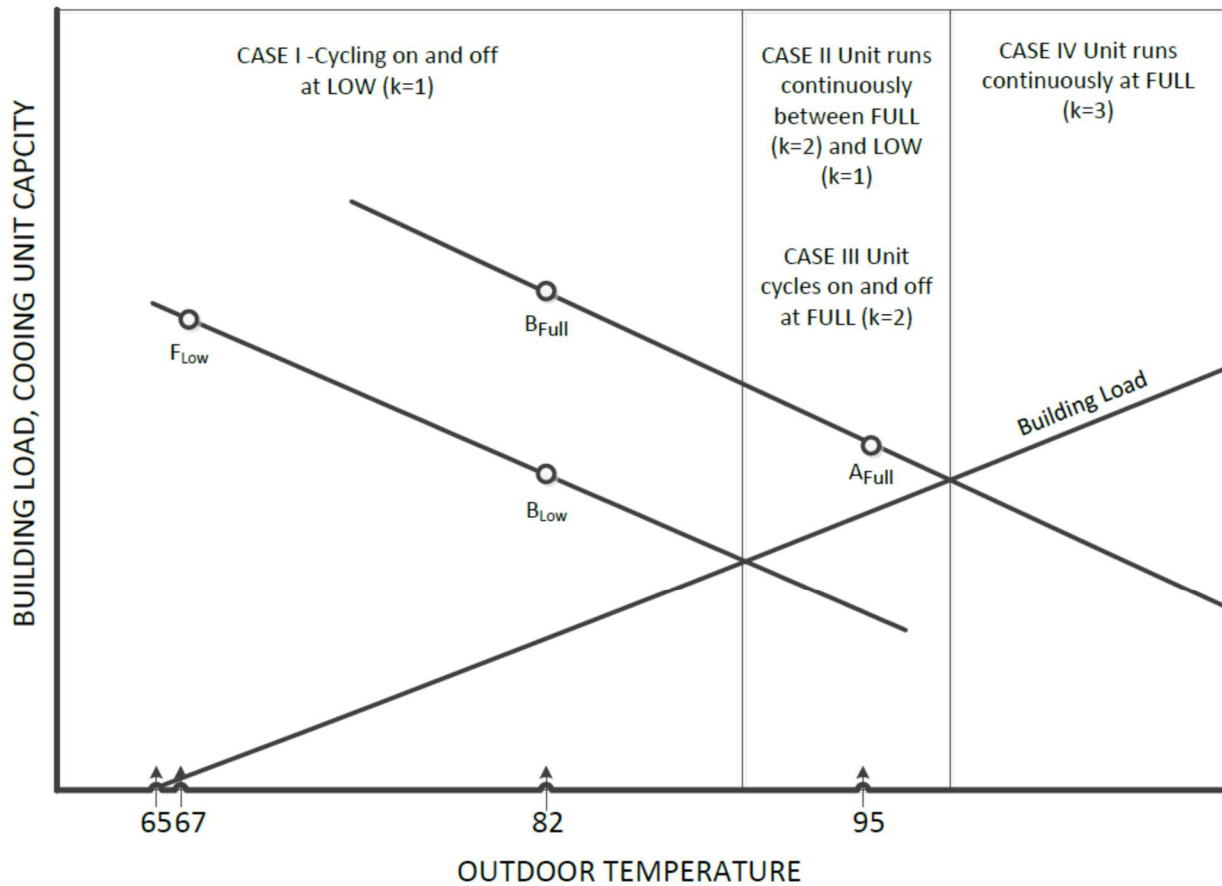

Figure 5. Schematic of a Two-speed System Operation in the Cooling Mode (See Tables 8 and 9 for Temperature References)

The estimated building load for each bin temperature shall be calculated using Equation 11.60.

$$BL(t_j) = \left(\frac{t_j - 65}{95 - 65} \right) \cdot \left(\frac{\dot{q}_{A,Full}}{SF} \right) \tag{11.60}$$

Where:

$$SF = 1.1 \tag{11.61}$$

The calculated low stage system capacity rate at each bin temperature shall be calculated by Equation 11.62.

$$\dot{q}_{Low}(t_j) = \dot{q}_{F,Low} + \left\{ \frac{\dot{q}_{B,Low} - \dot{q}_{F,Low}}{82 - 67} \right\} \cdot (t_j - 67) \tag{11.62}$$

The calculated low stage energy consumption at each bin temperature shall be calculated by Equation 11.63.

$$P_{Low}(t_j) = P_{F,Low} + \left\{ \frac{P_{B,Low} - P_{F,Low}}{82 - 67} \right\} \cdot (t_j - 67) \tag{11.63}$$

The calculated high stage system capacity at each bin temperature shall be calculated by Equation 11.64.

$$\dot{q}_{Full}(t_j) = \dot{q}_{B,Full} + \left\{ \frac{\dot{q}_{A,Full} - \dot{q}_{B,Full}}{95 - 82} \right\} \cdot (t_j - 82) \tag{11.64}$$

The calculated high stage energy consumption at each bin temperature shall be calculated by Equation 11.65.

$$P_{Full}(t_j) = P_{B,Full} + \left\{ \frac{P_{A,Full} P_{A,Full} - P_{B,Full} P_{B,Full}}{95-8} \right\} \cdot (t_j - 82) \quad 11.65$$

11.2.1.2.1 *Case I. Building load is less than low stage capacity, $BL(t_j) < \dot{q}_{Low}(t_j)$.* Calculate total bin capacity by using Equation 11.66 and total bin energy by using Equation 11.67.

$$q(t_j) = CLF^{Low}(t_j) \cdot \dot{q}_{Low}(t_j) \cdot n_j \quad 11.66$$

$$E(t_j) = \frac{CLF^{Low}(t_j) \cdot P_{Low}(t_j) \cdot n_j}{PLF^{Low}(t_j)} \quad 11.67$$

Where:

$$CLF^{Low}(t_j) = \frac{BL(t_j)}{\dot{q}_{Low}(t_j)} \quad 11.68$$

$$PLF^{Low}(t_j) = 1 - C_D^{c,Low} \cdot [1 - CLF^{Low}(t_j)] \quad 11.69$$

$$C_D^{c,Low} = \frac{\left\{ 1 - \frac{EER_{D,Low}}{EER_{C,Low}} \right\}}{1 - CLF^{cyc,Low}} \quad 11.70$$

Where:

$$CLF^{cyc,Low} = \frac{q_{cyc,D,Low}}{(\dot{q}_{C,Low} \cdot \theta_{cyc})} \quad 11.71$$

If the optional Tests C and D (refer to Table 7) are not performed, or the calculated result for $C_D^{c,Low}$ is greater than the default value of Section 6.1.3.1, the default value shall be used.

11.2.1.2.2 *Case II. Building load is greater than the low stage capacity, but less than the high stage capacity, $\dot{q}_{Low}(t_j) < BL(t_j) < \dot{q}_{Full}(t_j)$ and the unit cycles between low stage operation and high stage operation.* Calculate total bin capacity by using Equation 11.72 and total bin energy by using Equation 11.73.

$$q(t_j) = [CLF^{Low} \cdot \dot{q}_{Low}(t_j) + CLF^{Full} \cdot \dot{q}_{Full}(t_j)] \cdot n_j \quad 11.72$$

$$E(t_j) = [CLF^{Low} \cdot P_{Low}(t_j) + CLF^{Full} \cdot P_{Full}(t_j)] \cdot n_j \quad 11.73$$

Where:

$$CLF^{Low} = \frac{\dot{q}_{Full}(t_j) - BL(t_j)}{\dot{q}_{Full}(t_j) - \dot{q}_{Low}(t_j)} \quad 11.74$$

$$CLF^{Full} = 1 - CLF^{Low} \quad 11.75$$

11.2.1.2.3 *Case III. Building load is greater than the low stage capacity, but less than the high stage capacity, $\dot{q}_{Low}(t_j) < BL(t_j) < \dot{q}_{Full}(t_j)$ and the unit cycles between off and high stage operation.* Calculate total bin capacity by using Equation 11.76 and total bin energy by using Equation 11.77.

$$q(t_j) = CLF^{Full} \cdot \dot{q}_{Full}(t_j) \cdot n_j \quad 11.76$$

$$E(t_j) = \frac{CLF^{Full} \cdot P_{Full}(t_j) \cdot n_j}{PLF^{Full}} \quad 11.77$$

Where:

$$CLF^{Full} = \frac{BL(t_j)}{\dot{q}_{Full}(t_j)} \quad 11.78$$

$$PLF^{Full} = 1 - C_D^{c,Full} \cdot [1 - CLF^{Full}] \quad 11.79$$

If the optional C_{Full} and D_{Full} Tests (see Table 7) are not conducted, set $C_D^{c,Full}$ equal to the lower of a) the $C_D^{c,Low}$ value calculated as per Equation 11.70; or b) the default value specified in section 6.1.3.1. If this optional test is conducted, set $C_D^{c,Full}$ to the value calculated as per Equation 11.80.

$$C_D^{c,Full} = \frac{\left\{ 1 - \frac{EER_{D,Full}}{EER_{C,Full}} \right\}}{1 - CLF^{cyc,Full}} \quad 11.80$$

Where $CLF^{cyc,Full}$ is calculated per Equation 11.58.

11.2.1.2.4 Case IV. Building load is greater than or equal to the unit capacity, $BL(t_j) \geq \dot{q}_{Full}(t_j)$. Calculate total bin capacity by using Equation 11.81 and total bin energy by using Equation 11.82.

$$q(t_j) = \dot{q}_{Full}(t_j) \cdot n_j \quad 11.81$$

$$E(t_j) = P_{Full}(t_j) \cdot n_j \quad 11.82$$

11.2.1.3 Variable Speed System. SEER for a Variable Speed System shall be calculated using Equation 11.59 where the quantities $q(t_j)$ and $E(t_j)$ are calculated for each individual Temperature Bin using the appropriate formula for each bin depending on the operating characteristics of the Variable Speed System as defined in this section. Bin temperatures and bin hours shall be realized from Table 16. When the building load is less than the unit capacity at low speed use Section 11.2.1.3.1. When the building load is greater than the unit capacity at low speed, but less than the unit capacity at full speed, use Section 11.2.1.3.2. When the building load is greater than the unit capacity at full speed use Section 11.2.1.3.3. See Figure 6 for a graphical representation.

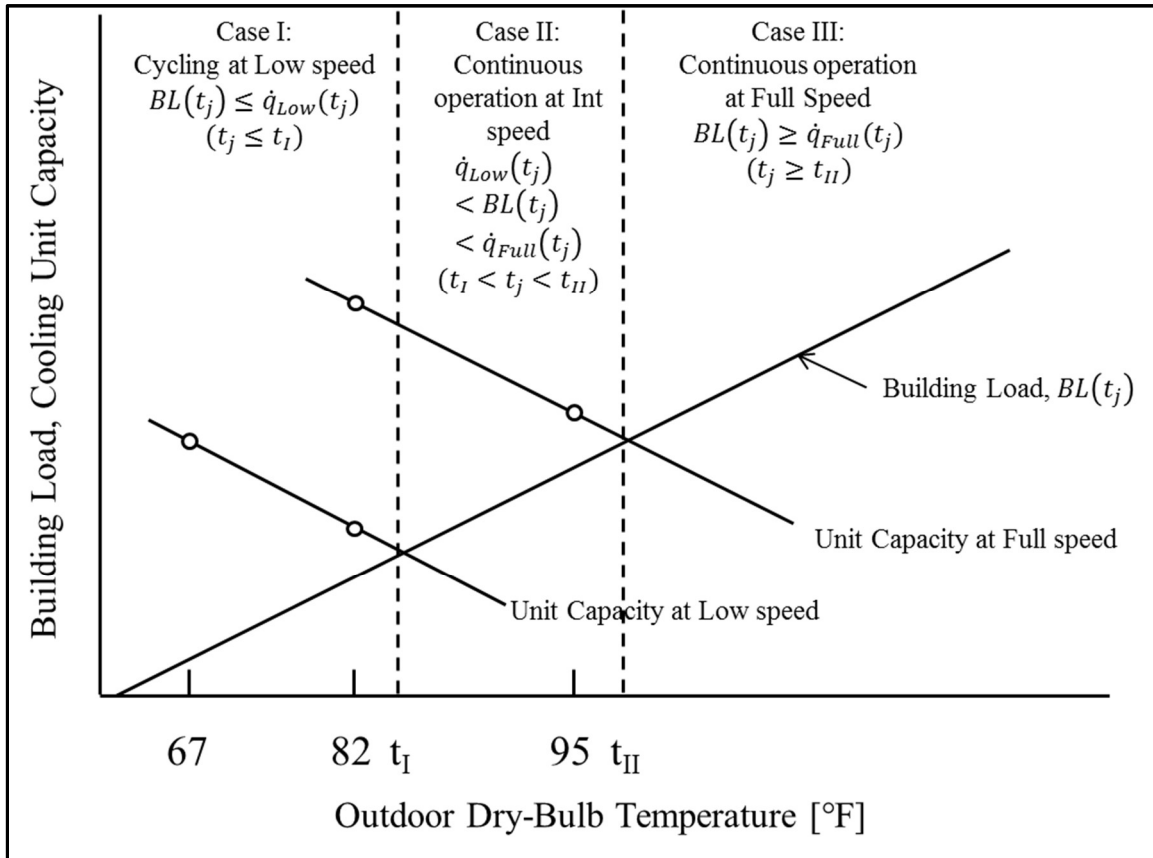

Figure 6. Schematic of a Variable Speed System Operation in the Cooling Mode

t_I is the outdoor ambient condition at which the building load equals the system capacity with the compressor operating at low speed. t_I shall be calculated as follows.

$$t_I = \frac{\dot{q}_{F,Low} + 6 \cdot F_1 - 67 \cdot F_2}{F_1 - F_2} \text{ (see Equation 11.86 and 11.87 for } F_1 \text{ and } F_2) \tag{11.83}$$

t_{vc} is the outdoor ambient condition at which the building load equals the system capacity with the compressor operating at intermediate speed. t_{vc} shall be calculated as follows.

$$t_{vc} = \frac{33 \cdot \dot{q}_{E,Int} - 2871 \cdot M_{Cq} + 6 \cdot \dot{q}_{A,Full}}{\dot{q}_{A,Full} - 33 \cdot M_{Cq}} \text{ (see Equation 11.94 for } M_{Cq}) \tag{11.84}$$

t_{II} is the outdoor ambient condition at which the building load equals the system capacity with the compressor operating at full speed. t_{II} shall be calculated as follows.

$$t_{II} = \frac{\dot{q}_{B,Full} + 65 \cdot F_1 - 82 \cdot F_3}{F_1 - F_3} \tag{11.85}$$

Where:

$$F_1 = \frac{\dot{q}_{A,Full}}{(95 - 6) \cdot SF} \text{ (see Equation 11.61 for SF)} \tag{11.86}$$

$$F_2 = \frac{\dot{q}_{B,Low} - \dot{q}_{F,Low}}{82 - 6} \tag{11.87}$$

$$F_3 = \frac{\dot{q}_{A,Full} - \dot{q}_{B,Full}}{95 - 8} \tag{11.88}$$

For each bin temperature, the building load, $BL(t_j)$, shall be calculated per Equation 11.60.

The calculated steady state capacity and energy consumption at the Full Compressor Speed for each bin temperature shall be calculated per Equations 11.64 and 11.65.

The calculated steady state capacity and energy consumption at the Low Compressor Speed for each bin temperature shall be calculated as follows.

$$\dot{q}_{Low}(t_j) = \dot{q}_{F,Low} + [\dot{q}_{B,Low} - \dot{q}_{F,Low}] \cdot \left[\frac{t_j - 67}{82 - 67} \right] \quad 11.89$$

$$P_{Low}(t_j) = P_{F,Low} + [P_{B,Low} - P_{F,Low}] \cdot \left[\frac{t_j - 67}{82 - 67} \right] \quad 11.90$$

The Total Cooling Capacity and energy at an intermediate speed for each bin temperature shall be calculated as follows, for individual bin calculation (see Section 11.2.3.1.2).

$$q(t_j) = BL(t_j) \cdot n_j \quad 11.91$$

$$E(t_j) = \frac{\dot{q}_{Int-Bin}(t_j)}{EER_{Int-Bin}(t_j)} \cdot n_j \quad 11.92$$

Intermediate steady state capacity for each bin temperature, $\dot{q}_{Int-Bin}(t_j)$, shall be calculated as follows, for intermediate compressor speed capacity rate, power and efficiency (Equations 11.93 to 11.106).

$$\dot{q}_{Int-Bin}(t_j) = \dot{q}_{E,Int} + M_{Cq}[t_j - 87] \quad 11.93$$

Where:

$$M_{Cq} = F_2 \cdot (1 - N_{Cq}) + F_3 \cdot N_{Cq} \quad 11.94$$

$$N_{Cq} = \frac{\dot{q}_{E,Int} - \dot{q}_{Low}(87)}{\dot{q}_{Full}(87) - \dot{q}_{Low}(87)} \quad 11.95$$

$\dot{q}_{Low}(87)$ shall be calculated per Equation 11.89.

Intermediate steady state power for each bin temperature, $P_{Int-B}(t_j)$, shall be calculated as follows.

$$P_{Int-B}(t_j) = P_{E,Int} + M_{CE}[t_j - 87] \quad 11.96$$

Where:

$$M_{CE} = \frac{P_{B,Low} - P_{F,Low}}{82 - 67} \cdot (1 - N_{CE}) + \frac{P_{A,Full} - P_{B,Full}}{95 - 82} \cdot N_{CE} \quad 11.97$$

$$N_{CE} = \frac{P_{E,Int} - P_{Low}(87)}{P_{Full}(87) - P_{Low}(87)} \quad 11.98$$

$P_{Low}(87)$ shall be calculated per Equation 11.90.

Intermediate efficiency, $EER_{Int-Bin}(t_j)$, shall be calculated as follows.

$$EER_{Int-Bin}(t_j) = a + b \cdot t_j + c \cdot t_j^2 \quad 11.99$$

Where:

$$a = EER_{FullLow}(t_{II}) - b \cdot t_{II} - c \cdot t_{II}^2 \quad 11.100$$

$$b = \frac{EER_{Low}(t_I) - EER_{Full}(t_{II}) - d \cdot [EER_{Low}(t_I) - EER_{Int=Bin}(t_{vc})]}{t_I - t_{II} - d \cdot [t_I - t_{vc}]} \quad 11.101$$

$$c = \frac{EER_{Low}(t_I) - EER_{Full}(t_{II}) - b \cdot [t_I - t_{II}]}{t_I^2 - t_{II}^2} \quad 11.102$$

$$d = \frac{t_{II}^2 - t_I^2}{t_{vc}^2 - t_I^2} \quad 11.103$$

$$EER_{Full}(t_{II}) = \frac{\dot{q}_{Full}(t_{II})}{P_{Full}(t_{II})} \quad 11.104$$

$$EER_{Low}(t_I) = \frac{\dot{q}_{Low}(t_I)}{P_{Low}(t_I)} \quad 11.105$$

$$EER_{Int}(t_{vc}) = \frac{\dot{q}_{Int}(t_{vc})}{P_{Int}(t_{vc})} \quad 11.106$$

11.2.1.3.1 *Case I - Building load is no greater than unit capacity at low speed, $BL(t_j) \leq \dot{q}_{Low}(t_j)$, where $(t_j \leq t_I)$. Equations from Section 11.2.1.2.1 shall be used to calculate capacity and energy consumption for each bin temperature using Equations 11.66 and 11.67 for the calculated system capacity and energy consumption at the Low Compressor Speed for each bin temperature and calculate $C_D^{c,Low}$ per Equation 11.107.*

$$C_D^{c,Low} = \frac{\left\{1 - \frac{EER_{I,Low}}{EER_{G,Low}}\right\}}{1 - CLF^{cyc,Low}} \quad 11.107$$

Use Equation 11.71 to calculate $CLF^{cyc,low}$ except substitute Tests G and I for Test C and D. If the optional Tests G and I (refer to Table 7) are not performed, or the calculated result for $C_D^{c,Low}$ is greater than the default value of Section 6.1.3.1, the default value shall be used.

11.2.1.3.2 *Case II - Building load can be matched by modulating the compressor speed between low speed and full speed, $\dot{q}_{Low}(t_j) < BL(t_j) < \dot{q}_{Full}(t_j)$, where $(t_I < t_j < t_{II})$. Use Equations 11.91 and 11.92 to calculate the Total Cooling Capacity and energy calculations for each bin.*

11.2.1.3.3 *Case III - Building load is equal to or greater than unit capacity at full stage. $BL(t_j) \geq \dot{q}_{Full}(t_j)$, where $(t_j \geq t_{II})$. Use the equations in Section 11.2.1.2.4 to calculate the Total Cooling Capacity and energy for each bin.*

11.2.2 *HSPF.*

11.2.2.1 *Single Stage System.* HSPF for a Single Stage System shall be calculated using Equation 11.108.

$$HSPF = \frac{\sum_{j=1}^{18} n_j BL(t_j)}{\sum_{j=1}^{18} \frac{n_j HLF(t_j) \delta(t_j) E(t_j)}{PLF(t_j)} + \sum_{j=1}^{18} RH(t_j)} \cdot F_{def} \quad 11.108$$

Where:

$$BL(t_j) = \left\{ \frac{65 - t_j}{65 - t_{OD}} \right\} \cdot C \cdot DHR_{min} \quad 11.109$$

$$C = 0.77 \quad 11.110$$

For Regions I, II, III, IV, and VI:

$$DHR_{min} = \frac{\dot{q}_{H1,Full}[65-t_{OD}]}{60} \tag{11.111}$$

$$DHR_{max} = \frac{2 \cdot \dot{q}_{H1,Full}[65-t_{OD}]}{60} \tag{11.112}$$

For Region V:

$$DHR_{min} = \dot{q}_{H1,Full} \tag{11.113}$$

$$DHR_{max} = 2.2 \cdot \dot{q}_{H1,Full} \tag{11.114}$$

DHR_{min} and DHR_{max} , as calculated by Equations 11.111-11.114 shall be rounded to the closest value displayed in Table 17.

5,000	25,000	50,000	90,000
10,000	30,000	60,000	100,000
15,000	35,000	70,000	110,000
20,000	40,000	80,000	130,000

Note: The Standard Rating (federally regulated) shall be based on DHR_{min} . DHR_{max} may be substituted for DHR_{min} to obtain a modified HSPF for higher building loads, as needed.

Distribution of fractional heating hours per Temperature Bin, n_j , for each bin, j , shall be obtained from Table 18.

Region ¹	I	II	III	IV	V	VI	
Heating Load Hours (HLH)	750	1250	1750	2250	2750	2750	
Outdoor Design Temperature (T_{OD}) for the region, °F	37	27	17	5	-10	30	
Fractional Hours:							
Bin #	t_j , °F						
$j = 1$	62	0.291	0.215	0.153	0.132	0.106	0.113
2	57	0.239	0.189	0.142	0.111	0.092	0.206
3	52	0.194	0.163	0.138	0.103	0.086	0.215
4	47	0.129	0.143	0.137	0.093	0.076	0.204
5	42	0.081	0.112	0.135	0.100	0.078	0.141
6	37	0.041	0.088	0.118	0.109	0.087	0.076
7	32	0.019	0.056	0.092	0.126	0.102	0.034
8	27	0.005	0.024	0.047	0.087	0.094	0.008
9	22	0.001	0.008	0.021	0.055	0.074	0.003
10	17	0	0.002	0.009	0.036	0.055	0

Table 18. Distribution of Fractional Heating Hours in Temperature Bins, Heating Load Hours, and Outdoor Design Temperature for Different Climatic Regions (Continued)

Fractional Hours:							
Bin #	$t_j, ^\circ\text{F}$						
11	12	0	0	0.005	0.026	0.047	0
12	7	0	0	0.002	0.013	0.038	0
13	2	0	0	0.001	0.006	0.029	0
14	-3	0	0	0	0.002	0.018	0
15	-8	0	0	0	0.001	0.010	0
16	-13	0	0	0	0	0.005	0
17	-18	0	0	0	0	0.002	0
18	-23	0	0	0	0	0.001	0

Note 1. Heating domestic regions are shown in Figure 7.

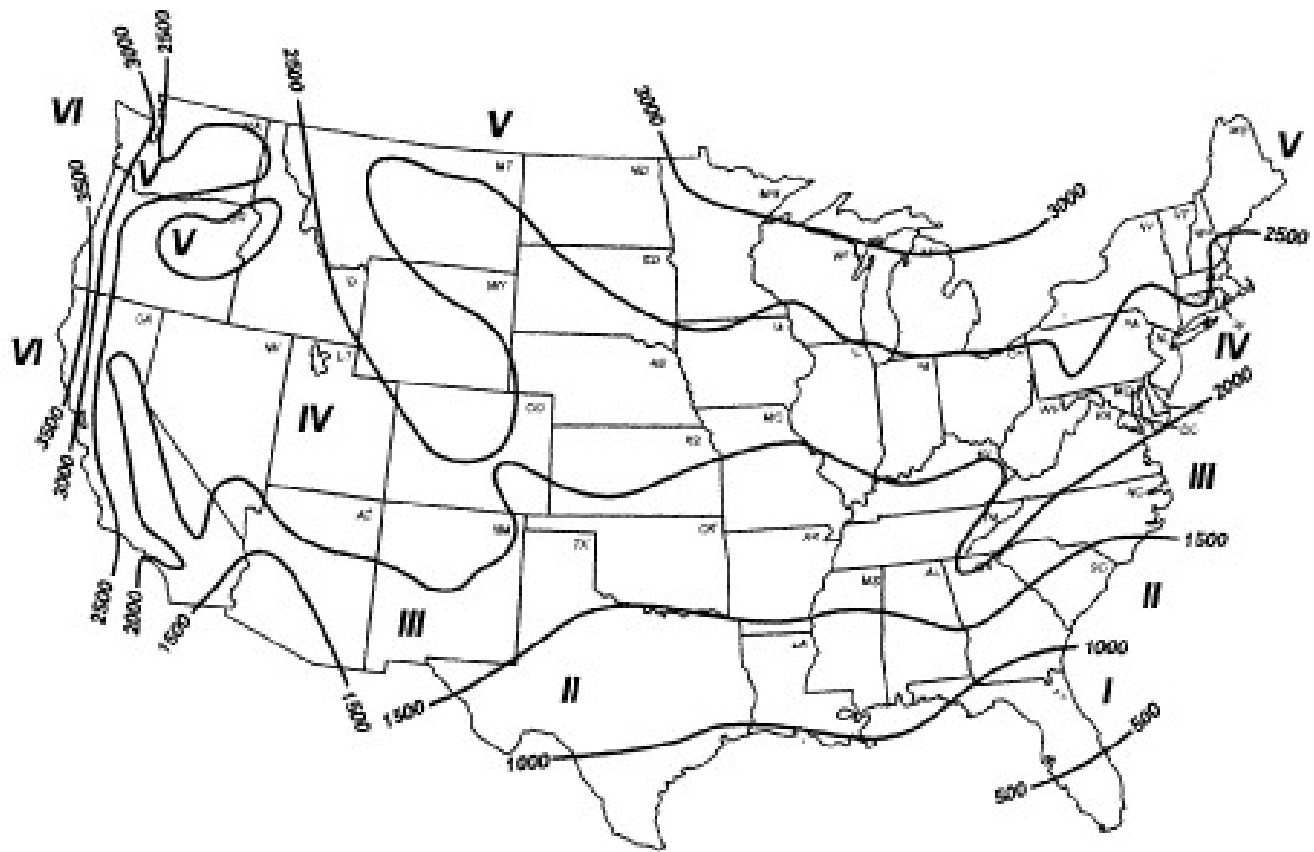

Figure 7. Heating Load Hours (HLH_A) for the United States

$HLF(t_j)$ shall be calculated depending upon the cases below

For $\dot{q}_{Full}(t_j) > BL(t_j)$

$$HLF^{Full}(t_j) = \frac{BL(t_j)}{\dot{q}_{Full}(t_j)}$$

11.115

For $\dot{q}_{Full}(t_j) \leq BL(t_j)$

$$HLF^{Full}(t_j) = 1 \quad 11.116$$

$\dot{q}_{Full}(t_j)$ shall be calculated depending upon the cases below

For $t_j \geq t_{OBO}$ or $t_j \leq 17$

$$\dot{q}_{Full}(t_j) = \dot{q}_{H3,Full} + [\dot{q}_{H1,Full} - \dot{q}_{H3,Full}] \cdot \frac{[t_j - 17]}{47 - 17} \quad 11.117$$

For $17 < t_j < t_{OBO}$

$$\dot{q}_{Full}(t_j) = \dot{q}_{H3,Full} + [\dot{q}_{H2,Full} - \dot{q}_{H3,Full}] \cdot \frac{[t_j - 17]}{35 - 17} \quad 11.118$$

Where the temperature at which frosting influence on full stage performance begins, t_{OBO} , is specified to be:

$$t_{OBO} = 45 \quad 11.119$$

$\delta(t_j)$ shall be calculated depending upon the cases below

For $t_j \leq t_{OFF}$ or $\frac{\dot{q}_{Full}(t_j)}{3.412 \cdot P_{Full}(t_j)} < 1$

$$\delta(t_j) = 0 \quad 11.120$$

For $t_{OFF} < t_j \leq t_{ON}$ and $\frac{\dot{q}_{Full}(t_j)}{3.412 \cdot P_{Full}(t_j)} \geq 1$

$$\delta(t_j) = 0.5 \quad 11.121$$

For $t_j > t_{ON}$ and $\frac{\dot{q}_{Full}(t_j)}{3.412 \cdot P_{Full}(t_j)} \geq 1$

$$\delta(t_j) = 1 \quad 11.122$$

The outdoor temperature below which the compressor ceases to operate, t_{OFF} , is defined by the controls of the manufacturer, as is the outdoor temperature at which the compressor reinitiates operation, t_{ON} . If the controls of the unit prohibit compressor operation based on outdoor temperature, the manufacturer shall specify in product literature t_{OFF} and t_{ON} values.

$P(t_j)$ shall be calculated depending upon the cases below

For $t_j \geq t_{OBO}$ or $t_j \leq 17$

$$P_{Full}(t_j) = P_{H3,Full} + [P_{H1,Full} - P_{H3,Full}] \cdot \frac{[t_j - 17]}{47 - 17} \quad 11.123$$

For $17 < t_j < t_{OBO}$

$$P_{Full}(t_j) = P_{H3,Full} + [P_{H2,Full} - P_{H3,Full}] \cdot \frac{[t_j - 17]}{35 - 17} \quad 11.124$$

$$PLF^{Full}(t_j) = 1 - C_D^{h,Full} [1 - HLF^{Full}(t_j)] \quad 11.125$$

$$RH(t_j) = \frac{[BL(t_j) - q_{Full}(t_j) HLF^{Full}(t_j) \delta(t_j)]}{3.412} \cdot n_j \quad 11.126$$

$$C_D^{h,Full} = \frac{\left\{ 1 - \frac{COP_{H1C,Full}}{COP_{Cyc,H1,Full}} \right\}}{1 - HLF^{Cyc,Full}} \quad 11.127$$

$$HLF^{Cyc,Full} = \frac{\dot{q}'_{H1C,Full}}{(\dot{q}'_{H1,Full} \cdot \theta_{cyc})} \quad 11.128$$

If the optional Cyclic Test H1C_{Full} (refer to Table 7) is not performed, or the calculated result for $C_D^{h,Full}$ is greater than the default value of Section 6.1.3.2, the default value shall be used.

For systems with Demand-defrost Control System (see Definitions 3.14.1 and 3.14.2)

$$F_{def} = 1 + 0.03 \left(1 - \frac{T_{test} - 9}{T_{max} - 9} \right) \quad 11.129$$

For other systems

$$F_{def} = 1 \quad 11.130$$

Where:

$$T_{test} = \text{Time between defrost terminations in minutes, or 90, whichever is greater} \quad 11.131$$

$$T_{max} = \text{Maximum time between defrosts allowed by controls in minutes, or 720, whichever is smaller} \quad 11.132$$

Figure 8 shows a graphical representation of the operation of a Single-speed Heat Pump.

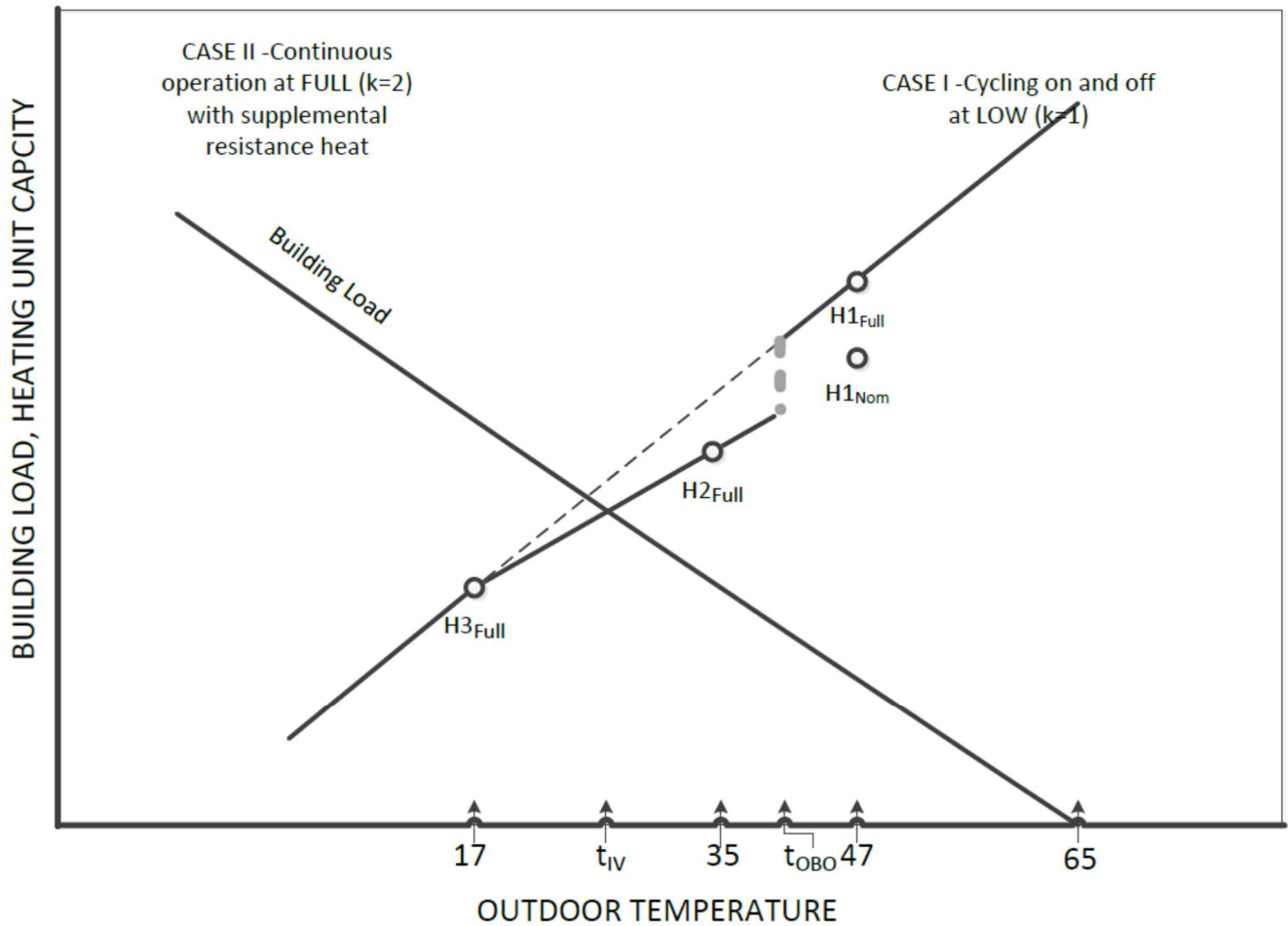

Figure 8. Schematic of a Single-speed Heat Pump Operation

11.2.2.2 Two-stage System. HSPF for a Two-stage System shall be calculated using Equation 11.133.

$$HSPF = \frac{\sum_{j=1}^{18} n_j BL(t_j)}{\sum_{j=1}^{18} E(t_j) + \sum_{j=1}^{18} RH(t_j)} \cdot F_{def} \quad 11.133$$

HSPF for Two-stage System is calculated using the same method as for Single Stage Systems with the exception that the bin energy consumption, $E(t_j)$, is calculated based on the cases defined below. See Figure 9 for a graphical representation.

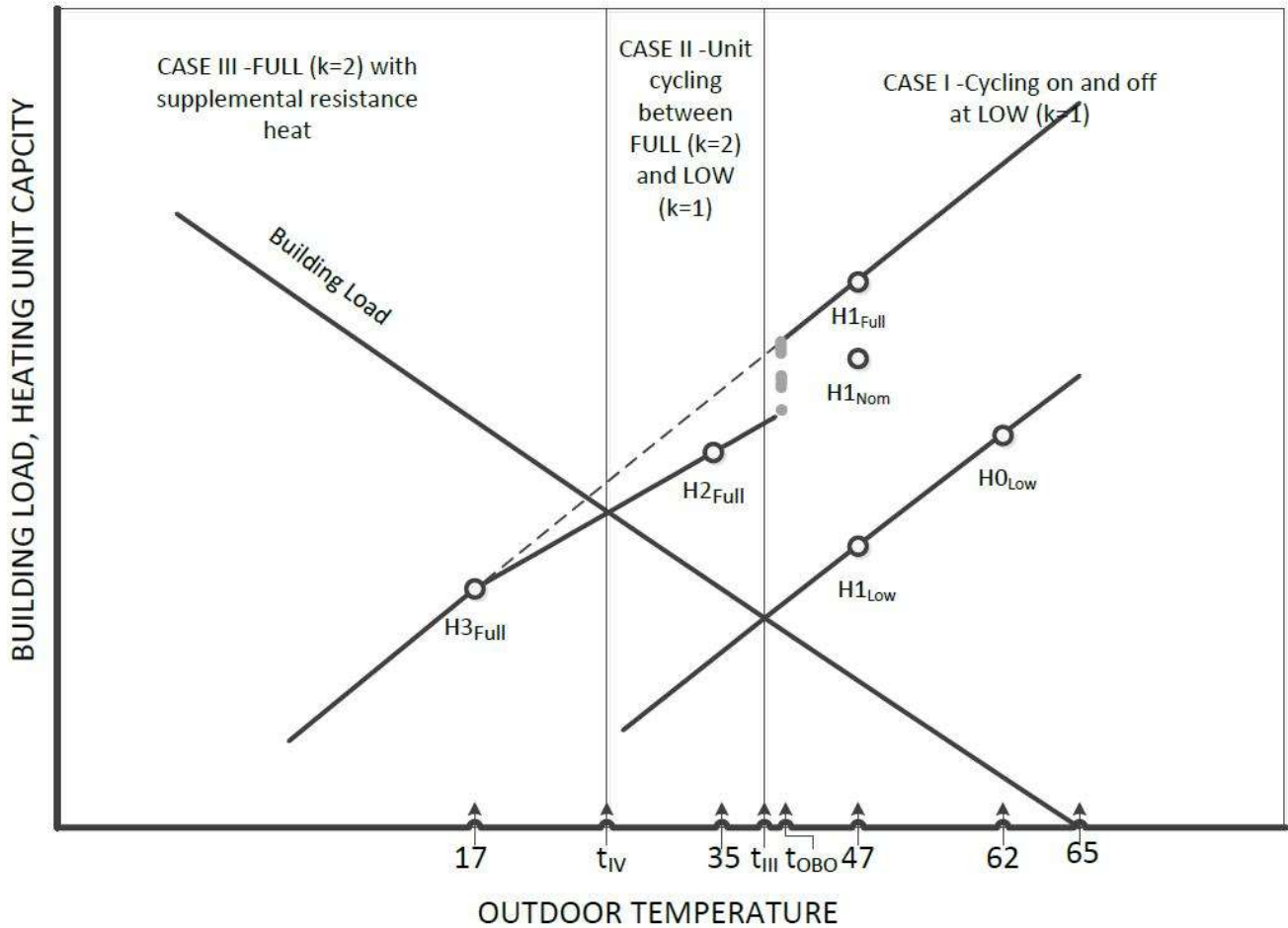

Figure 9. Schematic of a Two-speed Heat Pump Operation

For two speed heat pumps, the temperature at which frosting influence on low stage performance begins, t_{OB} , is specified to be:

$$t_{OB} = 40 \tag{11.134}$$

The calculated low stage system capacity at each bin temperature shall be calculated depending upon the cases below

For $t_j \geq t_{OB}$

$$\dot{q}_{Low}(t_j) = \dot{q}_{H1,Low} + [\dot{q}_{H0,Low} - \dot{q}_{H1,Low}] \cdot \frac{t_j - 47}{62 - 47} \tag{11.135}$$

For $17 < t_j < t_{OB}$

$$\dot{q}_{Low}(t_j) = \dot{q}_{H3,Low} + [\dot{q}_{H2,Low} - \dot{q}_{H3,Low}] \cdot \frac{t_j - 1}{35 - 17} \tag{11.136}$$

For $t_j \leq 17$

$$\dot{q}_{Low}(t_j) = \dot{q}_{H3,Low} + [\dot{q}_{H1,Low} - \dot{q}_{H3,Low}] \cdot \frac{t_j - 1}{47 - 17} \tag{11.137}$$

The calculated low stage system energy consumption rate at each bin temperature shall be calculated depending upon the cases below.

For $t_j \geq t_{OB}$

$$P_{Low}(t_j) = P_{H1,Low} + [P_{H0,Low} - P_{H1,Low}] \cdot \frac{t_j^{-4}}{62-47} \quad 11.138$$

For $17 < t_j < t_{OB}$

$$P_{Low}(t_j) = P_{H3,Low} + [P_{H2,Low} - P_{H3,Low}] \cdot \frac{t_j^{-1}}{35-17} \quad 11.139$$

For $t_j \leq 17$

$$P_{Low}(t_j) = P_{H3,Low} + [P_{H1,Low} - P_{H3,Low}] \cdot \frac{t_j^{-1}}{47-17} \quad 11.140$$

The calculated full stage system capacity at each bin temperature shall be calculated depending upon the cases per Equations 11.117 and 11.118.

11.2.2.2.1 *Case I. Building load is less than low stage capacity, $BL(t_j) \leq \dot{q}_{Low}(t_j)$.* Calculate total bin energy by using Equation 11.141.

$$E(t_j) = \frac{P_{Low}(t_j) \cdot HLF^{Low}(t_j) \delta'(t_j) n_j}{PLF^{Low}(t_j)} \quad 11.141$$

$$RH(t_j) = \frac{BL(t_j)[1-\delta'(t_j)]}{3.412} \cdot n_j \quad 11.142$$

$$HLF^{Low}(t_j) = \frac{BL(t_j)}{\dot{q}_{Low}(t_j)} \quad 11.143$$

$$PLF^{Low}(t_j) = 1 - C_D^{h,Low} [1 - HLF^{Low}(t_j)] \quad 11.144$$

Where:

$$C_D^{h,Low} = \frac{\left\{ 1 - \frac{COP_{H1C,Low}}{COP_{Cyc,H1,Low}} \right\}}{1 - HLF^{Cyc,Low}} \quad 11.145$$

$$HLF^{Cyc,Low} = \frac{q'_{H1C,Low}}{(q'_{H1,Low} \cdot \theta_{cyc})} \quad 11.146$$

$\delta'(t_j)$ shall be calculated depending upon the cases below.

$$\text{For } t_j \leq t_{OFF} \text{ or } \frac{\dot{q}_{Low}(t_j)}{3.412 \cdot P_{Low}(t_j)} < 1$$

$$\delta'(t_j) = 0 \quad 11.147$$

For $t_{OFF} < t_j \leq t_{ON}$

$$\delta'(t_j) = 0.5 \quad 11.148$$

For $t_j > t_{ON}$

$$\delta'(t_j) = 1 \quad 11.149$$

Use calculations from Section 11.2.2.3 for any bin where the heat pump locks out low capacity operation at low outdoor temperatures and t_j is below the lockout threshold temperature, t_{OFF} .

11.2.2.2.2 *Case II. Building load is greater than the low stage capacity, but less than the high stage capacity, $\dot{q}_{Low}(t_j) < BL(t_j) < \dot{q}_{High}(t_j)$ and the unit cycles between low stage operation and high stage operation. Calculate total bin energy by using Equation 11.150. $RH(t_j)$ is calculated using Equation 11.142.*

$$E(t_j) = [P_{Low}(t_j)HLF^{Low}(t_j) + P_{Full}(t_j)HLF^{Full}(t_j)] \cdot \delta'(t_j)n_j \quad 11.150$$

$$HLF^{Low}(t_j) = \frac{\dot{q}_{Full}(t_j) - BL(t_j)}{\dot{q}_{Full}(t_j) - \dot{q}_{Low}(t_j)} \quad 11.151$$

$$HLF^{Full}(t_j) = 1 - HLF^{Low}(t_j) \quad 11.152$$

$\delta'(t_j)$ shall be calculated per Equations 11.147, 11.148 and 11.149.

11.2.2.2.3 *Case III. Building load is greater than the low stage capacity, but less than the high stage capacity, $\dot{q}_{Low}(t_j) < BL(t_j) < \dot{q}_{High}(t_j)$ and the unit cycles between off and high stage operation. Calculate total bin energy by using Equation 11.153. $RH(t_j)$ is calculated using Equation 11.142.*

$$E(t_j) = \frac{P_{Full}(t_j) \cdot HLF^{Full}(t_j) \cdot \delta''(t_j) \cdot n_j}{PLF^{Full}(t_j)} \quad 11.153$$

$$HLF^{Full}(t_j) = \frac{BL(t_j)}{\dot{q}_{Full}(t_j)} \quad 11.154$$

$$PLF^{Full}(t_j) = 1 - C_D^{h,Full} [1 - HLF^{Low}(t_j)] \quad 11.155$$

$\delta''(t_j)$ shall be calculated per Equations 11.159, 11.160 and 11.161. If the optional $H1C_{Full}$ Test (see Table 7) is not conducted, set $C_D^{h,Full}$ equal to the default value specified in section 6.1.3.2. If this optional test is conducted, set $C_D^{h,Full}$ to the lower of a) the $C_D^{h,Full}$ value calculated as per Section 6.1.3.2; or b) the section 6.1.3.2 default value for $C_D^{h,Full}$.

11.2.2.2.4 *When the building load is greater than the unit capacity, $BL(t_j) \geq \dot{q}_{High}(t_j)$. Calculate total bin capacity by using Equation 11.81 and total bin energy by using Equation 11.156.*

$$E(t_j) = P_{Full}(t_j) \cdot HLF^{Full}(t_j) \cdot \delta''(t_j) \cdot n_j \quad 11.156$$

$$RH(t_j) = \frac{[BL(t_j) - \dot{q}_{Full}(t_j) \cdot HLF^{Full}(t_j) \cdot \delta''(t_j)]}{3.412} \cdot n_j \quad 11.157$$

$$HLF_{Full}(t_j) = 1.0 \quad 11.158$$

$\delta''(t_j)$ shall be calculated depending upon the cases below

$$\text{For } t_j \leq t_{OFF} \text{ or } \frac{\dot{q}_{Full}(t_j)}{3.412 \cdot P_{Full}(t_j)} < 1$$

$$\delta''(t_j) = 0 \tag{11.159}$$

$$\text{For } t_{OFF} < t_j \leq t_{ON} \text{ and } \frac{\dot{q}_{Full}(t_j)}{3.412 \cdot P_{Full}(t_j)} \geq 1$$

$$\delta''(t_j) = 0.5 \tag{11.160}$$

$$\text{For } t_j \geq t_{ON} \text{ and } \frac{\dot{q}_{Full}(t_j)}{3.412 \cdot P_{Full}(t_j)} \geq 1$$

$$\delta''(t_j) = 1 \tag{11.161}$$

11.2.2.3 Variable Speed System. HSPF for a Variable Speed System shall be calculated using Equation 11.133, except as noted below, substituting \dot{q}_x^{calc} for \dot{q}_x and P_x^{calc} for P_x and substituting $\dot{q}_{H1,Nom}$ for $\dot{q}_{H1,Full}$ in Equations 11.111 to 11.114. See Figure 10 for a graphical representation.

If the H1_{Full} test is conducted, set the capacity and power used for calculation of HSPF in Section 11.2.2.3 to be per Equations 11.162 and 11.163.

$$\dot{q}_{H1,Full}^{calc} = \dot{q}_{H1,Full} \tag{11.162}$$

$$P_{H1,Full}^{calc} = P_{H1,Full} \tag{11.163}$$

If the H1_{Nom} test is conducted using the same compressor speed as the H3_{Full} test, set the capacity and power used for calculation of HSPF in Section 11.2.2.3 to be per Equations 11.164 and 11.165.

$$\dot{q}_{H1,Full}^{calc} = \dot{q}_{H1,Nom} \tag{11.164}$$

$$P_{H1,Full}^{calc} = P_{H1,Nom} \tag{11.165}$$

If no H1 test is conducted at the same compressor speed as the H3_{Full} test, set the capacity and power used for calculation of HSPF in Section 11.2.2.3 to be per equations 11.166 and 11.167.

$$\dot{q}_{H1,Full}^{calc} = \dot{q}_{H3,Full} \cdot (1 + 30 \cdot CSF) \tag{11.166}$$

$$P_{H1,Full}^{calc} = P_{H3,Full} \cdot (1 + 30 \cdot PSF) \tag{11.167}$$

Where:

$CSF = 0.0204/^\circ F$, capacity slope factor for Split Systems
 $CSF = 0.0262/^\circ F$, capacity slope factor for Single Package Units
 $PSF = 0.00455/^\circ F$, power slope factor for all products

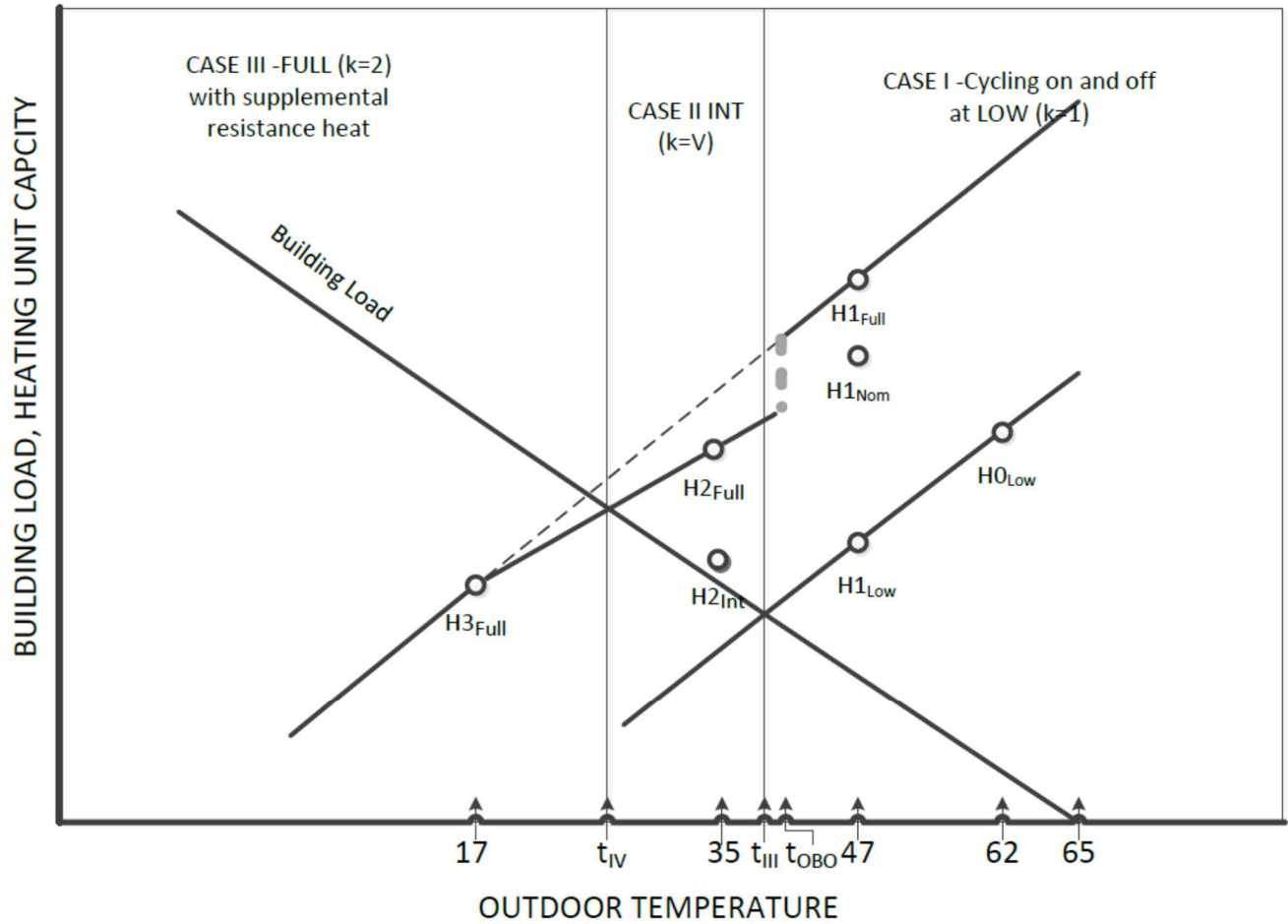

Figure 10. Schematic of a Variable Speed Heat Pump Operation

The outdoor temperature, t_{III} , at which the building load equals system capacity when the unit is operating at Low Compressor Speed, shall be calculated as follows.

$$t_{III} = \frac{65 \cdot F_1 + 47 \cdot F_2 - \dot{q}_{H1,Low}}{F_1 + F_2} \quad 11.168$$

Where:

$$F_1 = \frac{C \cdot DHR_{min}}{65 - t_{OD}} \quad 11.169$$

$$F_2 = \frac{\dot{q}_{H0,Low} - \dot{q}_{H1,Low}}{62 - 4} \quad 11.170$$

The outdoor temperature, t_{IV} , at which the building load equals system capacity when the unit is operating at Full Compressor Speed, shall be calculated per Equations 11.171 to 11.174. t_{IV} shall initially be calculated per Equation 11.171, however, if the result of t_{IV} is less than 17 then t_{IV} shall be calculated per Equation 11.173.

$$t_{IV} = \frac{65 \cdot F_1 + 17 \cdot F_3 - \dot{q}_{H3,Full}}{F_1 + F_3} \quad 11.171$$

Where:

$$F_3 = \frac{\dot{q}_{H2-Full} - \dot{q}_{H3,Full}}{35-1} \quad 11.172$$

$$t_{IV} = \frac{65 \cdot F_1 + 17 \cdot F_4 - \dot{q}_{H3,Full}}{F_1 + F_4} \quad 11.173$$

Where:

$$F_4 = \frac{\dot{q}_{H1,Full} - \dot{q}_{H3,Full}}{47-1} \quad 11.174$$

11.2.2.3.1 *Case I. Building Load is less than the capacity of the unit at the Low Compressor Speed, $\dot{q}_{Low}(t_j) \geq BL(t_j)$, where $(t_j \geq t_{III})$. Calculate $E(t_j)$ per Equation 11.141 and $RH(t_j)$ per Equation 11.142. Calculate bin capacity rate and bin energy rate at Low Compressor Speed by using Equations 11.175 and 11.176.*

$$\dot{q}_{Low}(t_j) = \dot{q}_{H1,Low} + [\dot{q}_{H0,Low} - \dot{q}_{H1,Low}] \cdot \frac{t_j - 47}{62 - 47} \quad 11.175$$

$$P_{Low}(t_j) = P_{H1,Low} + [P_{H0,Low} - P_{H1,Low}] \cdot \frac{t_j - 47}{62 - 47} \quad 11.176$$

11.2.2.3.2 *Case II. Building load can be matched by modulating the compressor speed between low speed and full speed, $\dot{q}_{Low}(t_j) < BL(t_j) < \dot{q}_{Full}(t_j)$, where $(t_{IV} < t_j < t_{III})$. Calculate total bin capacity by using Equation 11.177 and the total bin energy and by using Equation 11.178.*

$$\dot{q}(t_j) = \dot{q}_{Int-Bin}(t_j) \cdot n_j = BL(t_j) \cdot n_j \quad 11.177$$

$$E(t_j) = P_{Int-Bin}(t_j) \cdot n_j = \frac{\dot{q}_{Int-B}(t_j)}{3.412 \cdot COP_{Int-Bin}(t_j)} \quad 11.178$$

Where for $\dot{q}_{Low}(t_j) < BL(t_j) < \dot{q}_{Int-Bin}(t_j)$

$$COP_{Int-Bin}(t_j) = COP_{Low}(t_j) + \frac{COP_{Int}(t_j) - COP_{Low}(t_j)}{\dot{q}_{Int}(t_j) - \dot{q}_{Low}(t_j)} \cdot (BL(t_j) - \dot{q}_{Low}(t_j)) \quad 11.179$$

and for $\dot{q}_{Int-B}(t_j) < BL(t_j) < \dot{q}_{Full}(t_j)$

$$COP_{Int-Bin}(t_j) = COP_{Int}(t_j) + \frac{COP_{Full}(t_j) - COP_{Int}(t_j)}{\dot{q}_{Full}(t_j) - \dot{q}_{Int}(t_j)} \cdot (BL(t_j) - \dot{q}_{Int}(t_j)) \quad 11.180$$

Where $COP_{Low}(t_j)$ is calculated based on $\dot{q}_{Low}(t_j)$ from Equation 11.175 and $P_{Low}(t_j)$ from Equation 11.176, $COP_{Int}(t_j)$ is calculated based on $\dot{q}_{Int}(t_j)$ from Equation 11.181 and $P_{Int}(t_j)$ from Equation 11.184 and $COP_{Full}(t_j)$ is calculated based on $\dot{q}_{Full}(t_j)$ from Equations 11.190 or 11.192 and $P_{Full}(t_j)$ from Equations 11.189 or 11.191.

The integrated capacity of the unit at temperature t_j at Intermediate Compressor Speed, shall be calculated as follows.

$$\dot{q}_{Int-B}(t_j) = \dot{q}_{H2,Int} + M_{Hq}[t_j - 35] \quad 11.181$$

Where:

$$M_{Hq} = \frac{\dot{q}_{H0,Low} - \dot{q}_{H1,Low}}{62-47} \cdot (1 - N_{Hq}) + \frac{\dot{q}_{H2,Full} - \dot{q}_{H3,Full}}{35-1} \cdot N_{Hq} \quad 11.182$$

$$N_{Hq} = \frac{\dot{q}_{H2,Int} - \dot{q}_{H2,Low}}{\dot{q}_{H2,Full} - \dot{q}_{H2,Low}} \quad 11.183$$

The electrical power of the unit at temperature t_j at Intermediate Compressor Speed, shall be calculated as follows.

$$P_{Int}(t_j) = P_{H2,Int} + M_{HE}[t_j - 35] \quad 11.184$$

Where:

$$M_{HE} = \frac{P_{H0,Low} - P_{H1,Low}}{62-47} \cdot (1 - N_{HE}) + \frac{P_{H2,Full} - P_{H3,Full}}{35-17} \cdot N_{HE} \quad 11.185$$

$$N_{HE} = \frac{P_{H2,Int} - P_{H2,Low}}{P_{H2,Full} - P_{H2,Low}} \quad 11.186$$

The coefficient of performance of the unit at temperature t_{III} and t_{IV} , shall be calculated using Equations 11.187 and 11.188, respectively.

$$COP_{Low}(t_{III}) = \frac{\dot{q}_{Low}(t_{III})}{3.412 \cdot P_{Full}(t_{III})} \quad 11.187$$

$$COP_{Full}(t_{IV}) = \frac{\dot{q}_{Full}(t_{IV})}{3.412 \cdot P_{Full}(t_{IV})} \quad 11.188$$

11.2.2.3.3 *Case III. Building Load is greater than the capacity of the unit at the Full Compressor Speed, $\dot{q}_{Full}(t_j) \leq BL(t_j)$, where $(t_j \leq t_{IV})$. $E(t_j)$ shall be calculated using Equation 11.156, with Equations 11.189 or 11.191 used to determine the bin energy consumption rate when operating at Full Compressor Speed. $RH(t_j)$ shall be calculated using Equation 11.157, with Equations 11.190 or 11.192 used to determine the bin capacity rate when operating at Full Compressor Speed.*

For $t_j \geq 45^\circ F$ or $t_j \leq 17^\circ F$

$$P_{Full}(t_j) = P_{H3,Full} + [P_{H1,Full} - P_{H3,Full}] \cdot \frac{t_j - 17}{47 - 1} \quad 11.189$$

$$\dot{q}_{Full}(t_j) = \dot{q}_{H3,Full} + [\dot{q}_{H1,Full} - \dot{q}_{H3,Full}] \cdot \frac{t_j - 17}{47} \quad 11.190$$

For $17^\circ F < t_j \leq 45^\circ F$

$$P_{Full}(t_j) \dot{P}_{Full}(t_j) = P_{H3,Full} + [\dot{P}_{H2,Full} P_{H2,Full} - P_{H3,Full} \dot{P}_{H3,Full}] \cdot \frac{t_j - 17}{35 - 1} \quad 11.191$$

$$\dot{q}_{Full}(t_j) = \dot{q}_{H3,Full} + [\dot{q}_{H2,Full} - \dot{q}_{H3,Full}] \cdot \frac{t_j - 17}{35 - 17} \quad 11.192$$

11.2.2.4 *Heat Comfort Controller.* Heat pumps having a Heat Comfort Controller, the equations under Section 11.2.2.1-11.2.2.3 shall be used with the additions noted in this Section 11.2.2.4.

11.2.2.4.1 *Additional Steps for Calculating the HSPF of a Heat Pump having a Single-Speed Compressor that was Tested with a Fixed-Speed Indoor Fan Installed, a Constant-Air-Volume-Rate Indoor Fan Installed, or with No Indoor Fan Installed.* Calculate the space heating capacity and electrical power of the heat pump without the Heat Comfort Controller being active as specified in Section 11.2.2.1 for each outdoor bin temperature, t_j , that is listed in Table 18. Denote these capacities and electrical powers by using the subscript “hp” instead of “h.” Calculate the mass flow rate (expressed in pounds-mass of dry air per hour) and the specific heat of the indoor air (expressed in Btu/lbm_{da} · °F) from the results of the H1 Test using:

$$\dot{m}_{da} = 60 \dot{Q}_s \cdot \rho_{da} = \frac{60 \cdot \dot{Q}_{mi}}{v'_n \cdot [1 + W_n]} = \frac{60 \cdot \dot{Q}_{mi}}{v_n} \quad 11.193$$

Where

$$\rho_{da} = 0.075 \frac{\text{lbm}_{da}}{\text{ft}^3} \text{ and } 60 \text{ is a conversion from minutes to hours.}$$

$$C_{p,da} = 0.24 + 0.444 \cdot W_n \quad 11.194$$

For each outdoor bin temperature listed in Table 18, calculate the nominal temperature of the air leaving the heat pump condenser coil using,

$$T_o(t_j) = 70^\circ\text{F} + \frac{\dot{q}_{hp}(t_j)}{\dot{m}_{da} \cdot C_{p,da}} \quad 11.195$$

Calculate the HSPF using the equations found in Section 11.2.2.1 with the exception of the bin calculations shown below substituting $\dot{q}_{CC}(t_j)$ for $\dot{q}(t_j)$ and $P_{CC}(t_j)$ for $P(t_j)$.

For $T_o(t_j) \geq T_{CC}$, calculate $\dot{q}(t_j)$ and $P(t_j)$ using Section 11.2.2.1. Note: Even though $T_o(t_j) \geq T_{CC}$, resistive heating may be required; evaluate $RH(t_j)$ for all bins using the equation in Section 11.2.2.1.

For $T_o(t_j) < T_{CC}$, calculate $\dot{q}(t_j)$ and $P(t_j)$ using Equations 11.196 and 11.197.

$$\dot{q}_{CC}(t_j) = \dot{q}_{hp}(t_j) + \dot{m}_{da} C_{p,da} [T_{CC} - T_o(t_j)] \quad 11.196$$

$$P_{CC}(t_j) = P_{hp}(t_j) + \frac{\dot{m}_{da} \cdot C_{p,da} \cdot [T_{CC} - T_o(t_j)]}{3.412} \quad 11.197$$

Note: Even though $T_o(t_j) \geq T_{CC}$, additional resistive heating may be required; evaluate $RH(t_j)$ for all bins using the equation in Section 11.2.2.1.

11.2.2.4.2 *Additional Steps for Calculating the HSPF of a Heat Pump Having a Two-capacity Compressor.* Calculate the space heating capacity and electrical power of the heat pump without the Heat Comfort Controller being active as specified in Section 11.2.2.2 for both high and low capacity and at each outdoor bin temperature, t_j , that is listed in Table 18. Denote these capacities and electrical powers by using the subscript “hp” instead of “h.” For the low capacity case, calculate the mass flow rate (expressed in pounds-mass of dry air per hour) and the specific heat of the indoor air (expressed in Btu/lbm_{da} · °F) from the results of the H1_{Low} Test using:

$$\dot{m}_{da,Low} = 60 \cdot \dot{Q}_s \rho_{da} = \frac{60 \cdot \dot{Q}_{mi}}{v'_n \cdot [1 + W_n]} = \frac{60 \cdot \dot{Q}_{mi}}{v_n} \quad 11.198$$

$$C_{p,da,Low} = 0.24 + 0.444 \cdot W_n \quad 11.199$$

For each outdoor bin temperature listed in Table 18, calculate the nominal temperature of the air leaving the heat pump condenser coil when operating at low capacity using,

$$T_{o,Low}(t_j) = 70^\circ\text{F} + \frac{\dot{q}_{hp,Low}(t_j)}{\dot{m}_{da,Low} \cdot C_{p,da,Low}} \quad 11.200$$

Repeat the above calculations to determine the mass flow rate ($\dot{m}_{da, Full}$) and the specific heat of the indoor air ($C_{p,da,Full}$) when operating at high capacity by using the results of the H1_{Full} Test. For each outdoor bin temperature listed in Table 18, calculate the nominal temperature of the air leaving the heat pump condenser coil when operating at high capacity using,

$$T_{o,Full}(t_j) = 70^\circ\text{F} + \frac{\dot{q}_{hp,Full}(t_j)}{\dot{m}_{da,Full} \cdot C_{p,da,Full}} \quad 11.201$$

Evaluate $E(t_j)$, $RH(t_j)$, $HLF^{Low}(t_j)$, and/or $HLF^{Full}(t_j)$, $PLF_x(t_j)$, and $\delta'(t_j)$ or $\delta''(t_j)$ as specified in Sections 11.2.2.2.1, 11.2.2.2.2, 11.2.2.2.3, 11.2.2.2.4, whichever applies, for each Temperature Bin. To evaluate these quantities, use the low-capacity space heating capacity and the low-capacity electrical power from Case 1 or Case 2, whichever applies; use the high-capacity space heating capacity and the high-capacity electrical power from Case 3 or Case 4, whichever applies.

For $T_{o,Low}(t_j) \geq T_{CC}$, calculate $\dot{q}_{h,Low}(t_j)$ and $P_{h,Low}(t_j)$ using Section 11.2.2.2 (*i.e.*, $\dot{q}_{h,Low}(t_j) = \dot{q}_{hp,Low}(t_j)$ and $P_{h,Low}(t_j) = P_{hp,Low}(t_j)$). Note: Even though $T_{o,Low}(t_j) \geq T_{CC}$, resistive heating may be required; evaluate $RH(t_j)$ for all bins.

For $T_{o,Low}(t_j) < T_{CC}$, calculate $\dot{q}_{h,Low}(t_j)$ and $\dot{E}_{h,Low}(t_j)$ using Equations 11.202 and 11.203.

$$\dot{q}_{h,Low}(t_j) = \dot{q}_{hp,Low}(t_j) + \dot{q}_{CC,Low}(t_j) \quad 11.202$$

$$P_{h,Low}(t_j) = P_{hp,Low}(t_j) + P_{CC,Low}(t_j) \quad 11.203$$

Where:

$$\dot{q}_{CC,Low}(t_j) = \dot{m}_{da,Low} \cdot C_{p,da,Low} \cdot [T_{CC} - T_{o,Low}(t_j)] \quad 11.204$$

$$P_{CC,Low}(t_j) = \frac{\dot{q}_{CC,Low}(t_j)}{3.412} \quad 11.205$$

Note: Even though $T_{o,Low}(t_j) \geq T_{CC}$, additional resistive heating may be required; evaluate $RH(t_j)$ for all bins.

For $T_{o,Full}(t_j) \geq T_{CC}$, calculate $\dot{q}_{h,Full}(t_j)$ and $P_{h,Full}(t_j)$ using Section 11.2.2.2 (*i.e.*, $\dot{q}_{h,Full}(t_j) = \dot{q}_{hp,Full}(t_j)$ and $P_{h,Full}(t_j) = P_{hp,Full}(t_j)$). Note: Even though $T_{o,Full}(t_j) < T_{CC}$, resistive heating may be required; evaluate $RH(t_j)$ for all bins.

For $T_{o,Full}(t_j) < T_{CC}$, calculate $\dot{q}_{h,Full}(t_j)$ and $P_{h,Full}(t_j)$ using Equations 11.206 and 11.207.

$$\dot{q}_{h,Full}(t_j) = \dot{q}_{hp,Full}(t_j) + \dot{q}_{CC,Full}(t_j) \quad 11.206$$

$$P_{h,Full}(t_j) = P_{hp,Full}(t_j) + P_{CC,Full}(t_j) \quad 11.207$$

Where:

$$\dot{q}_{CC,Full}(t_j) = \dot{m}_{da,Full} \cdot C_{p,da,Full} \cdot [T_{CC} - T_{o,Full}(t_j)] \quad 11.208$$

$$P_{CC,Full}(t_j) = \frac{\dot{q}_{CC,Full}(t_j)}{3.412} \quad 11.209$$

Note: Even though $T_{o,Full}(t_j) \geq T_{CC}$, additional resistive heating may be required; evaluate $RH(t_j)$ for all bins.

11.2.2.4.3 *Additional Steps for Calculating the HSPF of a Heat Pump Having a Variable Speed Compressor.* [Reserved]

11.3 *Calculations of Off-Mode Power Consumption.* For central air-conditioners and heat pumps, Off-mode Power Consumption ($P_{W,Off}$) is tested per Appendix I and calculated as follows.

11.3.1 *Cooling Capacity Less Than 36,000 Btu/h.*

$$P_{W,Off} = \frac{P1+P2}{2} \quad 11.210$$

11.3.2 *Cooling Capacity Great Than or Equal to 36,000 Btu/h.* Calculate the capacity scaling factor (F_{scale}) where $\dot{Q}_c(95)$ is the total cooling capacity at the A_{Full} test conditions.

$$F_{scale} = \frac{\dot{Q}_c(95)}{36000} \quad 11.211$$

Determine the off-mode represented value, $P_{W,Off}$ with the following equation, rounding to the nearest watt.

$$P_{W,Off} = \frac{P1+P2}{2 \cdot F_{scale}} \quad 11.212$$

Section 12. Symbols, Subscripts and Superscripts

12.1 Symbols

a	Coefficients for determining intermediate EER for variable speed product
A	(When used in the equation for IEER) EER at 100% Net Capacity at AHRI Standard Rating Conditions
b	Coefficients for determining intermediate EER for variable speed product
B	(When used in the equation for IEER) EER at 75% Net Capacity and reduced condenser temperature (see Table 12)
$BL(t_j)$	Building load at bin temperature t_j , Btu/h
c	Coefficients for determining intermediate EER for variable speed product
COP_x	Coefficient of performance for test x
$COP_{cyc,x}$	Coefficient of performance during cyclic
$COP_{def,x}$	Coefficient of performance during defrost
$COP(y)$	Coefficient of performance for bin y
$COP_x(y)$	Coefficient of performance at condition x, for bin y, where x equals “cyc,” “Full,” “Int” or “Low”
c_{pa}	Specific heat of air, Btu/lbm _{da} ·°F
c_{pa2}	Specific heat of air leaving the indoor side, Btu/lbm _{da} ·°F
c_{pa4}	Specific heat of air leaving the outdoor side, Btu/lbm _{da} ·°F
$c_{p,da,x}$	Specific heat of dry air for condition x, Btu/lbm _{da} ·°F
C	(When used in the equation for HSPF) an experience factor that tends to improve the agreement between calculated and measured building loads
C	(When used in the equation for IEER) EER at 50% Net Capacity and reduced condenser temperature (see Table 12)
C_D	The Degradation Coefficient to account for cycling of the compressor for capacity less than the minimum step of capacity
C_D^C	Cooling Degradation Coefficient, applies to both “Full” and “Low”
$C_D^{C,x}$	Cooling Degradation Coefficient, where x equals “Full” or “Low”

C_D^h	Heating Degradation Coefficient, applies to both “Full” and “Low”
$C_D^{h,x}$	Heating Degradation Coefficient, where x equals “Full” or “Low”
CLF^x	Cooling load factor for condition x , where x equals “cyc,” “Full” or “Low”
CLH_A	Cooling load hours, actual
d	Coefficients for determining intermediate EER for variable speed product
D	(when used in the equation for IEER) EER at 25% Net Capacity and reduced condenser temperature (see Table 12)
DHR_{max}	Maximum Design Heating Requirement
DHR_{min}	Minimum Design Heating Requirement
$E_x(t_j)$	Total bin energy for test x , W·h, where x is blank, “Full” or “Low”
$E_{def,x}$	Total electrical energy used by the system during defrost test x , W·h
$E_{fan,x}$	Electrical energy used by the indoor fan for test x , W·h
$E_{m,x}$	Electrical energy consumed during test x as directly measured by instrumentation, W·h
$E_{cyc,x}$	Total electrical energy consumed for test x , W·h
$E_{cadj,x}$	Electrical energy adjustment calculated for Cyclic or defrost Test x , W·h
EER_x	Energy efficiency ratio for test x , Btu/W·h
$EER_x(y)$	Energy efficiency ratio for condition x , at y , where y can be t_j , t_I , t_{II} , etc., Btu/W·h
ESP_1	Lowest external static pressure where the unit is run with stability, in H ₂ O
ESP_2	Higher measured external static pressure, in H ₂ O
ESP_{FL}	External static pressure at full load airflow, in H ₂ O, as specified in Table 11
ESP_{min}	Target or minimum external static pressure, in H ₂ O
ESP_{PL}	External static pressure at part load airflow, in H ₂ O
F_1	Multipliers or adjustment factors
F_2	Multipliers or adjustment factors
F_3	Multipliers or adjustment factors
F_4	Multipliers or adjustment factors
F_{CD}	Cyclic correction factor
F_{CD}^*	Cyclic correction factor applied to the grid or thermopile measurement during the Cyclic Test
F_{def}	Demand-defrost enhancement factor
F_{scale}	Capacity scaling factor
h_{a1}	Enthalpy, air entering indoor side, Btu/lbm _{da}
h_{a2}	Enthalpy, air leaving indoor side, Btu/lbm _{da}
h_{a3}	Enthalpy, air entering outdoor side, Btu/lbm _{da}
h_{a4}	Enthalpy, air leaving outdoor side, Btu/lbm _{da}
h_{r1}	Enthalpy, vapor refrigerant indoor side, Btu/lbm
h_{r2}	Enthalpy, liquid refrigerant indoor side, Btu/lbm
HB_x	Heat balance for test x
HLF	Heating load factor
$HLF^x(t_j)$	Heat pump heating load factor at condition x at Temperature Bin j
HLH_A	Heating load hours, actual
$HSPF$	Heating Seasonal Performance Factor, HSPF
$IEER$	Integrated energy efficiency rating, IEER
LCL	Lower 90% confidence limit
L_f	Indoor coil fin length in inches, also height of the coil transverse to the tubes
LF	Fractional ON time for last stage at the desired load point
M_{CE}	Energy adjustment factor in cooling mode
M_{HE}	Energy adjustment factor in heating mode
M_{Cq}	Capacity adjustment factor in cooling mode
M_{Hq}	Capacity adjustment factor in heating mode
$\dot{m}_{da,x}$	Mass flow of dry air for condition x , lb _m /h where x is blank, “Full” or “Low”
$\dot{m}_{ref,x}$	Mass flow of refrigerant-oil mixture for condition x , lb _m /h
n	Number of systems tested, number of bins
n_c	Number of compressors
n_s	Number of single stage compressors
n_v	Number of Variable Speed Compressors
n_j	Fractional bin hours in the j th Temperature Bin
N_{CE}	Energy adjustment factor in cooling mode

N_f	Number of fins
N_{HE}	Energy adjustment factor in heating mode
N_{Cq}	Capacity adjustment factor in cooling mode
N_{Hq}	Capacity adjustment factor in heating mode
$NGIFS$	Normalized gross indoor fin surface
$P1$	Off-mode power in Shoulder Season, per compressor, W
$P1_x$	Off-mode power in Shoulder Season, total, W
$P2$	Off-mode power in Heating Season, per compressor, W
$P2_x$	Off-mode power in Heating Season, total, W
P_x	Low voltage power, W
PL	The standard rating point i.e. 75%, 50%, 25%
PLF^x	Part Load Factor for condition x , where x is blank, “Full” or “Low”
$PLF(0.5)$	Part Load Factor for SEER
$PLF^x(t_j)$	Part Load Factor for condition x at Temperature Bin j , where x is blank, “Full” or “Low”
P_{adj}	Indoor fan power adjustment, W
P_C	Compressor power at the lowest machine unloading point operating at the desired part load rating condition, W
$P_{C,x}$	Compressor power during test x , W
$P_{CC}(t_j)$	Power for Heat Comfort Controller at bin temperature t_j , W
P_{CD}	Condenser Section power, if applicable at the desired part load rating condition, W. For air-cooled and Evaporatively-cooled Air-conditioners this is the power of the fans and pumps.
P_{CT}	Control circuit power and any auxiliary loads, W
$P_{def,x}$	Power used during defrost test x , W
$P_{fan,1}$	Measured power input of the indoor fan at external static pressure 1, W
$P_{fan,2}$	Measured power input of the indoor fan at external static pressure 2, W
$P_{fan,x}$	Fan power during test x , W
P_{IF}	Indoor fan motor power at the fan speed for the minimum step of capacity, W
$P_{m,x}$	System power measured during test x , W
$P_{tot,x}$	Total power for test x , W
$P_{W,off}$	Off-mode power, W
P_x	When used with off-mode testing P_x is low voltage power, otherwise, power for test x
$P_x(y)$	Power at condition x , W , at temperature y , where x is blank, “Full,” “Int” or “Low” and y is any Temperature Bin
$PS_{adj,x}$	Power adjustment for steady state test x , W
q_x	Capacity, Btu
$\dot{q}_{A,Full}$	Rated full load Net Capacity, Btu/h
$\dot{q}_{CC}(t_j)$	Total bin capacity rate for Heat Comfort Controller, Btu/h
\dot{q}_x	Indoor capacity for test x before any duct or blower adjustments, Btu/h
$\dot{q}_{i,x}$	Part load Net Capacity, Btu/h
$q_x(t_j)$	Total bin capacity for speed x , Btu, where x is blank, “Full” or “Low”
$\dot{q}_x(t_j)$	Total bin capacity rate for condition x , Btu/h, where x is blank, “Full” or “Low”
$q_{def,x}$	Heating capacity during defrost test x , Btu
$\dot{q}_{def,x}$	Heating capacity rate during defrost test x , Btu/h
$\dot{q}_{duct,ci}$	Indoor duct loss rate in cooling, Btu/h
$\dot{q}_{duct,hi}$	Indoor duct loss rate in heating, Btu/h
$\dot{q}_{ref,x}$	Total capacity as measured by the refrigerant enthalpy method, Btu/h
$\dot{q}_{Sadj,x}$	Capacity adjustment for indoor motor heat during Steady State Test x , Btu/h
\dot{q}_{Low}	Low stage capacity, Btu/h
$\dot{q}_{tci,x}$	Total cooling capacity for test x , indoor side data, Btu/h
$\dot{q}_{tco,x}$	Total cooling capacity for test x , outdoor side data, Btu/h
$\dot{q}_{thi,x}$	Heating Steady State Net Total Heating Capacity for test x – indoor side, Btu/h
$\dot{q}_{tho,x}$	Heating Steady State Net Total Heating Capacity for test x – outdoor side, Btu/h
$q'_{cyc,x}$	Cooling or Heating Cyclic Net Total Capacity for Test x , Btu
\dot{q}_{adj}	Capacity adjustment, Btu/h
$q_{Cadj,x}$	Capacity adjustment for indoor motor heat during Cyclic or defrost Test x , Btu
$\dot{Q}_C(95)$	Total cooling capacity of the A or A ₂ test conditions, Btu/h

$\dot{Q}_{A,Full}$	Cooling full airflow rate, scfm
\dot{Q}_{Full}	Cooling full airflow rate as measured after setting and/or the adjustment as described in Section 6.1.5.2, scfm
\dot{Q}	Net Capacity at the lowest machine unloading point operating at the desired part load rating condition, Btu/h
$\dot{Q}_{H1,Full}$	Heating full airflow rate, cfm
\dot{Q}_i	Airflow Rate for test i , scfm
$\dot{Q}_{i,x}$	Airflow Rate for test i , scfm
\dot{Q}_{max}	Maximum measured airflow value, cfm
\dot{Q}_{mi}	Airflow, indoor, measured, cfm
\dot{Q}_{mo}	Airflow, outdoor, measured, cfm
\dot{Q}_{mx}	Air volume rate of air mixture, cfm
\dot{Q}_{min}	Minimum measured airflow value, cfm
\dot{Q}_s	Standard airflow, indoor, cfm
Q_{var}	Airflow variance, percent
$RH(t_j)$	Supplementary resistance heat at temperature (t_j), W·h
s	Standard deviation
scfm _{FL}	Standard Supply Airflow at full load rated conditions, scfm
scfm _{PL}	Standard Supply Airflow at part load rated conditions, scfm
SEER	Seasonal energy efficiency ratio, Btu/W·h
SF	Sizing factor, by convention
$t_{.90}$	t statistic for a 90% one-tailed confidence interval with sample size n
t_{a0}	Temperature, outdoor ambient, dry bulb, °F
t_{a1}	Temperature, air entering indoor side, dry bulb, °F
$t_{a1}(\theta)$	Dry-bulb temperature of air entering the indoor coil at elapsed time τ , °F; only recorded when indoor airflow is occurring
t_{a12}	Temperature, air entering outdoor side, dry bulb, °F
t_{a2}	Temperature, air leaving indoor side, dry bulb, °F
$t_{a2}(\theta)$	Dry-bulb temperature of air leaving the indoor coil at elapsed time τ , °F; only recorded when indoor airflow is occurring
t_{a3}	Temperature, air entering outdoor side, dry bulb, °F
t_{a4}	Temperature, air leaving outdoor side, dry bulb, °F
t_I	Outdoor ambient condition at which the building load equals the system capacity with the compressor operating at low speed
t_{II}	Outdoor ambient condition at which the building load equals the system capacity with the compressor operating at full speed
t_{III}	Outdoor ambient condition at which the building load equals the system integrated capacity with the compressor operating at low speed in heating mode
t_{IV}	Outdoor ambient condition at which the building load equals the system integrated capacity with the compressor operating at full speed in heating mode
t_j	Bin reference temperature, °F
t_{OB} and t_{OBO}	Temperatures that are boundaries of a bin to which the frost influence is extended, 40 °F and 45 °F, respectively, °F
t_{OD}	Tudoor design temperature, °F
t_{OFF}	The outdoor temperature at which the compressor is automatically stopped. If the compressor is not automatically controlled, t_j is considered greater than what might be t_{OFF} and t_{ON} , °F
t_{ON}	The outdoor temperature at which the compressor is automatically turned ON (if applicable) if designed for low-temperature automatic shutoff, °F
T_{max}	Maximum time between defrosts allowed by controls in minutes, or 720, which ever is smaller, minutes
T_{test}	Time between defrost terminations in minutes, or 90, whichever is greater, minutes
T_{cc}	Maximum supply temperature allowed by the comfort controller, °F
$T_{o,x}(t_j)$	Nominal temperature of air leaving the heat pump coil for condition x , °F
t_{vc}	Temperature at which $\dot{q}_{Int}(t) = BL(t)$; °F
t_{vh}	Temperature at which building load is equal to the capacity when the unit is defrosting, °F
$UA_{ID,ro}$	Product of the overall heat transfer coefficient and surface area for the indoor coil return duct that is located in the outdoor test room, Btu/h·°F
$UA_{ID,si}$	Product of the overall heat transfer coefficient and surface area for the indoor coil supply duct that

	is located in the indoor test room, Btu/h·°F
$UA_{ID,so}$	Product of the overall heat transfer coefficient and surface area for the indoor coil supply duct that is located in the outdoor test room, Btu/h·°F
UCL	Upper 90% confidence limit
v_n	Specific volume of air at dry- and wet-bulb temperature conditions existing at nozzle but at standard barometric pressure, ft ³ /lb of dry air
v'_n	Specific volume of air at the nozzle, ft ³ /lbm of air-water vapor mixture
$W1$	Humidity ratio, air entering indoor side, kg water vapor per kg of dry air, lbm _{wv} /lbm _{da}
$W2$	Humidity ratio, air leaving indoor side, kg water vapor per kg of dry air, lbm _{wv} /lbm _{da}
$W4$	Humidity ratio, air entering outdoor side, kg water vapor per kg of dry air, lbm _{wv} /lbm _{da}
W_f	Number of fins
W_n	Humidity ratio at the nozzle, lbm _{wv} /lbm _{da}
x	Mass ratio, refrigerant to refrigerant/oil mixture
\bar{x}	Test sample mean
x_i	Test result value for test sample i

12.2 Greek Symbols.

Γ	The integrated (with respect to elapsed time) air temperature difference across the indoor coil, °F·h
Γ_{ON}	The integrated air temperature difference across the indoor coil during the defrost cycle, °F·h
θ	Time, hours
θ_{cyc}	Duration of time for one complete cycle consisting of one compressor ON time and one compressor OFF time, hours
θ_1	For Ducted Systems, the elapsed time when airflow is initiated through the Indoor Coil; for Non-ducted Systems, the elapsed time when the compressor is cycled on, h
θ_2	The elapsed time when indoor coil airflow ceases, h
θ_3	Time at the initial defrost termination, h
θ_4	Time at the successive defrost termination, h
$\delta(t_j)$	Heat pump low-temperature cutout factor
$\delta'(t_j)$	Heat pump low-temperature ON/OFF cutout factor (low stage only)
$\delta''(t_j)$	Heat pump low-temperature ON/OFF cutout factor (high stage only)
ρ_{da}	Density of dry air, lb _m /ft ³
$\Delta\theta_{FR}$	Elapsed time from defrost termination to defrost termination, hr
ΔP_{st_i}	Target minimum external static pressure for test i , in H ₂ O
$\Delta P_{st_{A,Full}}$	Minimum external static pressure target from A_{Full} test (Table 11), in H ₂ O
$\Delta P_{st_{Full}}$	Minimum external static pressure target for test A or A_{Full} (Table 11), in H ₂ O
ΔT_{RTD}	Temperature differential between inlet air stream and outlet air stream as measured by RTDs, or equivalent, meeting the accuracy requirements for steady state testing
ΔT_{TC}	Temperature differential between inlet air stream and outlet air stream as measured by thermo couple grid, thermos couple pile, or equivalent, meeting the response requirements for Cyclic Testing

12.3 Subscripts and Superscripts.

adj	Adjustment
a_0	Outdoor ambient
a_1	Air entering Indoor Unit
a_2	Air entering Indoor Unit
a_3	Air entering Outdoor Unit
a_4	Air entering Outdoor Unit
CE	Cooling mode, energy
Cq	Cooling mode, capacity
cyc	Cyclic
def	Defrost
$duct-ci$	Indoor duct loss during cooling
$duct-hi$	Indoor duct loss during heating
$Full$	Operation/compressor speed at full load test
HE	Heating mode, energy
Hq	Heating mode, capacity

<i>hp</i>	Performance provided by heat pump
<i>i</i>	Indoor
<i>ID-ro</i>	Indoor airflow, return side in outdoor room
<i>ID-si</i>	Indoor airflow, supply side in indoor room
<i>ID-so</i>	Indoor airflow, return side in outdoor room
<i>Int</i>	Operation/compressor speed at intermediate speed test
<i>Int-Bin</i>	Operation/compressor speed at part load bin condition
<i>j</i>	Bin number
<i>I</i>	Outdoor condition when low stage cooling capacity equals building load
<i>II</i>	Outdoor condition when high stage cooling capacity equals building load
<i>III</i>	Outdoor condition when low stage heating capacity equals building load
<i>IV</i>	Outdoor condition when high stage heating capacity equals building load
<i>Low</i>	Operation/compressor speed at low load test
<i>m</i>	Measured
<i>max</i>	Maximum
<i>mi</i>	Measured indoor
<i>min</i>	Minimum
<i>mo</i>	Measured outdoor
<i>ref</i>	Refrigerant
<i>r1</i>	Refrigerant vapor side of Indoor Unit
<i>r2</i>	Refrigerant liquid side of Indoor Unit
<i>s</i>	Standard
<i>ici</i>	Total cooling indoor
<i>tco</i>	Total cooling outdoor
<i>test</i>	Test
<i>thi</i>	Total heating indoor
<i>tho</i>	Total heating outdoor
<i>tot</i>	Total
<i>Var</i>	Variance
<i>x</i>	Variable for an individual test, measurement, or compressor set point. For example, x can be A_{Full} , B_{Low} , $H0_{Low}$, etc.

APPENDIX A. REFERENCES – NORMATIVE

A1 Listed here are all standards, handbooks and other publications essential to the formation and implementation of the standard. All references in this appendix are considered as part of this standard.

- A1.1** AHRI Standard 110-2016, *Air-Conditioning, Heating and Refrigerating Equipment Nameplate Voltages*, 2016, Air-Conditioning, Heating, and Refrigeration Institute, 2311 Wilson Boulevard, Suite 400, Arlington, VA 22201, U.S.A.
- A1.2** AHRI Standard 1230-2014 with Addendum 1, *Performance Rating of Variable Refrigerant Flow (VRF) Multi-Split Air-Conditioning and Heat Pump Equipment*, 2017, Air-Conditioning, Heating, and Refrigeration Institute, 2311 Wilson Boulevard, Suite 400, Arlington, VA 22201, U.S.A.
- A1.3** AHRI/CSA Standard 310/380-2017, *Standard for Packaged Terminal Air-Conditioners and Heat Pumps (CSA.C744-14)*, 2017, Air-Conditioning, Heating, and Refrigeration Institute, 2311 Wilson Boulevard, Suite 400, Arlington, VA 22201, U.S.A.
- A1.4** AHRI Standard 340/360-2015, *Performance Rating of Commercial and Industrial Unitary Air-Conditioning and Heat Pump Equipment*, 2015, Air-Conditioning, Heating, and Refrigeration Institute, 2311 Wilson Boulevard, Suite 400, Arlington, VA 22201, U.S.A.
- A1.5** AHRI Unitary Small Equipment Operations Manual – January 2017, *Unitary Small Air-Conditioners and Air-Source Heat Pumps (Includes Mixed-Match Coils) (Rated Below 65,000 Btu/H) Certification Program*, Air-Conditioning, Heating, and Refrigeration Institute, 2311 Wilson Boulevard, Suite 400, Arlington, VA 22201, U.S.A.
- A1.6** ANSI/ASHRAE Standard 116-2010 (RA2015), *Methods of Testing for Rating Seasonal Efficiency of Unitary Air Conditioners and Heat Pumps*, 2010, American Society of Heating, Refrigerating and Air-Conditioning Engineers, Inc., 1791 Tullie Circle, N.E., Atlanta, GA 30329, U.S.A.
- A1.7** ANSI/ASHRAE Standard 37-2009 (RA2015), *Methods of Testing for Rating Electrically Driven Unitary Air-Conditioning and Heat Pump Equipment*, 2009, American Society of Heating, Refrigerating and Air-Conditioning Engineers, Inc., 1791 Tullie Circle, N.E., Atlanta, GA 30329-5478, U.S.A.
- A1.8** ANSI/AHRI Standard 390-2003, *Performance Rating of Single Package Vertical Air-Conditioners and Heat Pumps*, 2003, Air-Conditioning, Heating, and Refrigeration Institute, 2111 Wilson Boulevard, Suite 500, Arlington, VA 22201, U.S.A.
- A1.9** ANSI/ASHRAE Standard 41.1-2013, *Standard Method for Temperature Measurement*, 2013, American Society of Heating, Refrigerating and Air-Conditioning Engineers, Inc., 1791 Tullie Circle, N.E., Atlanta, GA 30329, U.S.A.
- A1.10** ANSI/ASHRAE Standard 41.4-2015, *Standard Method for Measuring the Proportion of Lubricant in Liquid Refrigerant*, 2013, American Society of Heating, Refrigerating and Air-Conditioning Engineers, Inc., 1791 Tullie Circle, N.E., Atlanta, GA 30329, U.S.A.
- A1.11** ANSI/ASHRAE Standard 41.6-2014, *Standard Method for Humidity Measurement*, 2014, American Society of Heating, Refrigerating and Air-Conditioning Engineers, Inc., 1791 Tullie Circle, N.E., Atlanta, GA 30329, U.S.A.
- A1.12** ANSI/ASHRAE Standard 41.9-2011, *Standard Methods for Volatile-Refrigerant Mass Flow Measurements Using Calorimeters*, 2011, American Society of Heating, Refrigerating and Air-Conditioning Engineers, Inc., 1791 Tullie Circle, N.E., Atlanta, GA 30329, U.S.A.
- A1.13** ANSI/ASHRAE/AMCA Standard 51-2016, *Laboratory Methods of Testing Fans for Aerodynamic Performance Rating* (ANSI/AMCA Standard 210-16), 2016, American Society of Heating, Refrigerating and Air-Conditioning Engineers, Inc., 1791 Tullie Circle, N.E., Atlanta, GA 30329-5478, U.S.A., Air Movement and Control Association International, Inc., 30 West University Drive, Arlington Heights, IL 60004-1893. U.S.A.

- A1.14** ASHRAE Handbook Fundamentals - 2017, *Fundamentals*, 2017, American Society of Heating, Refrigerating and Air-Conditioning Engineers, Inc., 1791 Tullie Circle, N.E., Atlanta, GA 30329, U.S.A.
- A1.15** ASHRAE Standard 41.2-1987 (RA 1992), *Standard Methods for Laboratory Airflow Measurement*, 1992, American Society of Heating, Refrigerating and Air-Conditioning Engineers, Inc., 1791 Tullie Circle, N.E., Atlanta, GA 30329, U.S.A.
- A1.16** ASHRAE, *Terminology*, <https://www.ashrae.org/resources--publications/free-resources/ashrae-terminology>, 2019, American Society of Heating, Refrigerating and Air-Conditioning Engineers, Inc., 1791 Tullie Circle, N.E., Atlanta, GA 30329, U.S.A.
- A1.17** ASTM Standard B117-2016, *Standard Practice for Operating Salt Spray (Fog) Apparatus*, 2011, American Society for Testing and Materials, 100 Barr Harbor Drive, P.O. Box C700, West Conshohocken, PA, 19428-2959, USA.
- A1.18** ASTM Standard G85-2011, *Standard Practice for Modified Salt Spray (Fog) Testing*, 2011, American Society for Testing and Materials, 100 Barr Harbor Drive, P.O. Box C700, West Conshohocken, PA, 19428-2959, USA.
- A1.19** IEC Standard 60038, *IEC Standard Voltages*, 2009, International Electrotechnical Commission, 3, rue de Varembe, P.O. Box 131, 1211 Geneva 20, Switzerland.
- A1.20** ISO/ANSI/AHRI/ASHRAE 13256-1, *Water-source heat pumps – Testing and rating for performance – Part 1: Water-to-air and Brine-to-air heat pumps*, 2012, International Organization for Standardization, Case Postale 56, CH-1211, Geneva 21 Switzerland.
- A1.21** ISO/ANSI/AHRI/ASHRAE 13256-2, *Water-source heat pumps – Testing and rating for performance – Part 2: Water-to-water and Brine-to-water heat pumps*, 2012, International Organization for Standardization, Case Postale 56, CH-1211, Geneva 21 Switzerland.
- A1.22** ISO/IEC 17025-2005, *General Requirements for the Competence of Testing and Calibration Laboratories*, 2005, International Organization for Standardization, Case Postale 56, CH-1211, Geneva 21 Switzerland.
- A1.23** NIST Standard Reference Database 23, *Reference Fluid Thermodynamic and Transport Properties – REFPROP Version 9.1*, 2010, National Institute of Standards and Technology, 100 Bureau Drive, Gaithersburg, Md. 20899.
- A1.24** Title 10, *Code of Federal Regulations (CFR)*, Part 429 and 430, U.S. National Archives and Records Administration, 8601 Adelphi Road, College Park, MD 20740-6001 or www.ecfr.gov.
- A1.25** UL Standard 555, *Standard for Fire Dampers*, 2006, Underwriters Laboratories, Inc., 333 Pfingsten Road, Northbrook, IL, U.S.A.
- A1.26** UL Standard 555S, *Standard for Smoke Dampers*, 2014, Underwriters Laboratories, Inc., 333 Pfingsten Road, Northbrook, IL, U.S.A.

APPENDIX B. REFERENCES – INFORMATIVE

B1 Listed here are standards, handbooks and other publications which may provide useful information and background but are not considered essential. References in this appendix are not considered part of the standard.

None.

APPENDIX C. CERTIFICATION OF LABORATORY FACILITIES USED TO DETERMINE PERFORMANCE OF UNITARY AIR-CONDITIONING & AIR-SOURCE HEAT PUMP EQUIPMENT – INFORMATIVE

Foreword: This appendix to the AHRI Standard 210/240 is the “LEAP Process” referred to in Section 3.2.2 of the AHRI Unitary Small Equipment (USE) Operations Manual (OM).

Preamble

Laboratory Evaluation and Adjustment Plan (LEAP) is based on scientific principles and the tolerances of individual tests are considered achievable by a test facility that is common to the industry. The LEAP is designed to normalize different laboratories with the goal of reducing variability between laboratory setups and locations. This appendix is informative but can be used within any organization to improve laboratory correlation. The plan is unique in that it attempts to calibrate using absolutes rather than the usual relative standard associated with round robin correlation testing. It is important to use the same geometry and sampling techniques that shall be used in unitary testing to correctly correlate the facility. It is also important to run the testing in the order shown below and apply any corrections from the previous section before moving on to the next.

The first step (5.1) is to run electric heat tests in order to assure the sensible electric heat can be measured accurately psychrometrically. Adjustment factors are applied to the nozzle combinations that compensate for tunnel irregularities and sampling deficiencies. The change in temperature between entering and leaving allows an effective evaluation of humidity measurement errors. Improvements in sampling capability will typically reduce the correction factors to the nozzle combinations.

The second step (5.2) is to determine the thermal mass effects in the supply duct prior to the measurement plane. This test runs electric heat for six minutes and then turns it off. The heat stored in the duct work, mixer and sampler will appear in the air stream when the heater is turned off. By measuring the temperature of the largest mass from the time the heater is turned off until it is turned on again along with the integrated capacity measured during the off cycle provides a value for C_pM in ANSI/ASHRAE Standard 116 Section 7.4.3.4.5.

The third step (5.3) evaluates the integrity of the differential static pressure measurement. A static pressure box is used in three different configurations. The ideal situation is that the same result will occur in all three configurations. The first configuration is the ANSI/ASHRAE Standard 37 set up for Coil-Only Systems. The second is attaching the static pressure box to the inlet damper per the standard laboratory practice. The third is to compromise the return duct if a non-standard configuration is required for some testing Space Constrained Product. The static pressure shall be the same for all three tests, otherwise, the geometry shall be fixed.

The fourth step (5.4) uses a standard setup of a unit for an ‘A’ test. The ‘A’ test runs a rather long soak time followed by several ‘A’ tests in a row. Condensate is collected and compared to the psychrometric calculation. The tolerance for error determines if the unit is ready for the next step which is a modified round robin sequence.

The final step (5.5) is a modified round robin test. The main modification is that the system is charged in cooling and in heating. The difference in charge is an indication of facility consistency. The tolerances of the individual tests are quite tight and the relationship between the tests in each facility is tight.

Once LEAP is thoroughly completed the indoor facilities will be well vetted. Outdoor sampling has not been addressed except for the final step where the round robin results need to match from facility. If adjustments need to be made to pass the final step, then the outdoor sampling would be a place to start.

C1 Purpose. The purpose of this appendix is to establish, for laboratory facilities used to determine performance of Unitary Air-Conditioners and Unitary Air-source Heat Pumps, definitions, test requirements, certification requirements and documentation requirements that provide a uniform method to evaluate and adjust the quality of test data produced for the AHRI USE Certification Program.

C1.1 Intent.

C1.1.1 *Third Party Laboratories.* This appendix is intended to be the minimum requirement, along with ISO Standard 17025 accreditation, to qualify a Laboratory Facility for use as a third party partner in the AHRI USE Certification Program.

C1.1.2 *Original Equipment Manufacturer (OEM) Laboratories.* This appendix is intended to be a guideline, along with ISO Standard 17025 compliance, to qualify a test facility for use as an OEM in the AHRI USE Certification Program.

C1.2 *Review and Amendment.* This appendix is subject to review and amendment as technology advances.

C2 *Scope.* This standard applies to any laboratory facility that performs tests used to determine performance of Unitary Air-Conditioners and Unitary Air-source Heat Pumps within the AHRI USE Certification Program, as defined in Section 3.

C3 *Definitions.*

All terms in this Appendix will follow the standard industry definitions in the ASHRAE Terminology website (<https://www.ashrae.org/resources--publications/free-resources/ashrae-terminology>) and the definitions in Section 3 unless otherwise defined in this section.

C3.1 *Code Tester.* A chamber with one or more nozzles, diffusion baffles and mixing plates used to measure air flow rate (reference ASHRAE Standard 37 Section 6); sometimes referred to as a wind tunnel.

C3.2 *Laboratory Certification Tests.* Any test used in the determination of capacity and efficiency of a Unitary Air-Conditioner or Unitary Heat Pump; these tests are listed in AHRI Standard 210/240 Section 6.1.3. This includes tests during development of performance ratings or tests during auditing of performance ratings.

C3.3 *Laboratory Facility.* Any organization that has psychrometric test rooms, data acquisition, and other equipment necessary to determine the performance of a Unitary Air-Conditioner or Unitary Heat Pump, with the intent of using the facility for Laboratory Certification Tests or qualifying new product under the penalty mode in the latest edition of AHRI USE Operations Manual. An AHRI member, a non-AHRI member, or any other independent organization may be a Laboratory Facility.

C3.3.1 *Authorized Laboratory Facility.* A Laboratory Facility that has completed all tests in compliance with this appendix and has been provided with a letter of approval from AHRI for use of their facility for AHRI certification testing.

C3.3.2 *OEM Laboratory Facility.* A laboratory facility utilized by an Original Equipment Manufacturer to develop Certified Ratings.

C3.4 *Laboratory Evaluation & Adjustment Plan (LEAP).* A program to evaluate Laboratory Facilities used in performance testing of the AHRI USE Certification Program; the program provides the Laboratory with directions to adjust testing process and results in order to conform to the requirements of the AHRI USE Operations Manual.

C3.5 *Psychrometric Test Facility.* A pair of test chambers used to separately simulate indoor and outdoor ambient conditions, in which each chamber has the capability of separately controlling dry-bulb temperature and wet-bulb temperature within the chamber, and measuring various parameters of a unit under test.

C3.5.1 *Indoor Room.* A test chamber specifically intended for installation of an indoor section of a Unitary Air-Conditioner or Unitary Heat Pump, and designed to control ambient air in the range as specified in AHRI Standard 210/240 Section 6.1.4 indoor conditions.

C3.5.2 *Outdoor Room.* A test chamber specifically intended for installation of an outdoor section, or complete Single Package Unit, of a Unitary Air-Conditioner or Unitary Heat Pump, and designed to control ambient air in the range as specified in AHRI Standard 210/240 Section 6.1 outdoor conditions.

C3.6 *Test.* The time during which all required operating parameters are maintained within specification and measurements of the Psychrometric Test Facility ambient air conditions and Unit Under Test performance are recorded. For steady state operation Test time is typically 30 minutes. All Standard Tests prescribed in AHRI Standard 210/240 Section 6.1.3 are considered a Test.

C3.6.1 *Pre-conditioning Test.* The time during which all required operating parameters are brought within Standard Rating Conditions. For steady state operation, the last 30 minutes are typically required to have measured operating parameters within required operating tolerances.

C3.7 *Third Party Laboratory.* An independent, non-AHRI member; laboratory facility that operates under contract with AHRI to perform Laboratory Certification Tests on Unitary Air-Conditioners and Unitary Heat Pumps under the scope of the AHRI Unitary Small Equipment Section Operations Manual.

C3.8 *Unit Under Test (UUT).* The indoor section of a Split System with electric heat; the system used for round robin testing; or the static pressure reference device.

C4 *Test Requirements.* All Laboratory Certification Tests shall be conducted in accordance with modifications as dictated by the test methods and procedures as described in this appendix (Section 5 and Appendices). Each Psychrometric Test Facility that a Laboratory Facility is qualifying for use in the AHRI Standard 210/240 certification program shall be tested using Laboratory Certification Tests performed in accordance with the latest DOE test procedure, ANSI/ASHRAE Standard 37 and ANSI/ASHRAE Standard 116 unless expressly modified by this appendix.

C5 *Certification Requirements.*

C5.1 *Sensible Heat Capacity Evaluation of Code Tester.*

C5.1.1 *Purpose of the Test.* The purpose of the sensible heat capacity calibration of the code tester test is to compare the psychrometric measured sensible heat capacity to the total electrical energy input of the unit under test. This provides a Laboratory Facility with the ability to validate that its psychrometric measurement apparatus can measure the sensible heat capacity, prior to calibration, within 4% of the actual electrical energy input to the unit under test. After calibration, these tests shall allow for only nozzle selections for a given code tester that measure airflow rate within 2% after correction.

C5.1.2 *Selection of Equipment.*

C5.1.2.1 *Equipment Classification.* The UUT for sensible heat capacity evaluation shall be a production split system Air Handler with capability of having electric resistance heat installed internal to the UUT.

C5.1.2.2 *Equipment Size and Configuration.* The production equipment design shall be fitted with an electric heat module of at least 2 kW per maximum cooling ton. The heater shall be made of at least two separate elements, oriented side by side, and shall be located at the outlet of the Air Handler. The UUT wiring shall be modified so that electrical energy supplied to the heater may be varied separately from electrical energy supplied to the rest of the UUT. Typically, the psychrometric Outdoor Room power supply and measurement equipment will need to be used due to relatively high power requirements. Individual banks shall have the capability of being switched independently.

C5.1.3 *Test Setup.*

C5.1.3.1 The UUT shall be set up in the Indoor Room in accordance with ANSI/ASHRAE Standard 37 Section 6.4 through Section 6.6.

C5.1.3.2 All indoor electrical energy shall be measured with instrumentation which is in accordance with Section 5.4 of ANSI/ASHRAE Standard 37.

C5.1.3.3 If an indoor volatile refrigerant coil is present in the UUT it shall be void of refrigerant charge in order to eliminate any thermal siphoning.

C5.1.3.4 At the outlet sampler, nine individual thermocouples shall be placed in accordance with ANSI/ASHRAE Standard 116 Section 7.4.3.4.1 in order to assess the ability of the Code Tester to properly mix UUT outlet air. These thermocouples shall be out of the line of sight of the electric heat in order to avoid radiation effects. All thermocouples shall be compliant with ANSI/ASHRAE Standard 41.1 Section 10.

C5.1.4 *Test Procedure.*

C5.1.4.1 Indoor air inlet conditions shall be maintained at 70.0 ± 0.5 °F dry-bulb temperature and 65.0 ± 0.3 °F wet-bulb temperature.

C5.1.4.1.1 The Test Operating Tolerance for dry-bulb temperature shall not exceed 0.5 °F and for wet-bulb temperature shall not exceed 0.3 °F during the test.

C5.1.4.2 The Laboratory Facility shall select appropriate (commonly used) nozzle combinations to cover the airflow rate range for any foreseen Laboratory Certification Test (this range is typically 400 scfm to 2450 scfm for Unitary Small Equipment products). The selected nozzle combinations shall be referred to as the potential combinations, a subset of all nozzle combinations. Any such nozzle combination shall be in accordance with ANSI/ASHRAE Standard 37 Section 6.3.1.

C5.1.4.2.1 Prior to running any electric heat tests, it is necessary to verify that the entering and leaving RTD match when no load exists. Select an airflow between 1000 to 1400 range and allow the unit and facility to pre-condition for at least one hour. Run a test for 30 minutes using normal sample rates. Average the entering and leaving RTD temperatures and calculate the difference in the averages. If the difference exceeds 0.03 degrees then calibration of the facility RTDs or test setup investigation is required. An error at the upper end of this tolerance will result in heat balance errors of up to 0.25%.

C5.1.4.2.2 Over the various airflow rates to be tested, the voltage to the electric heat shall be varied in order to maintain a nominal 12 °F differential temperature across the Indoor Unit. Power to the heater shall be set within the range of 3.8 kW to 4.0 kW per 1000 SCFM measured.

C5.1.4.2.3 For each potential nozzle combination at least three airflow rates shall be tested, as described in Table C1. For the purpose of this Section C5.1, “test” shall be construed to be a single airflow rate for a given nozzle combination.

C5.1.4.3 Test data for each airflow rate shall be recorded at equal intervals, with a maximum interval period of one minute, over a 30 minute period. Upon completion of the Test, test data shall be averaged. For each airflow rate Test, there shall be a minimum 30 minute Pre-conditioning Test.

C5.1.4.4 For sensible heat balance calibration, the blower shall not be powered and the UUT shall have all joints and seams taped or sealed (internally and externally as required) for all tests to eliminate air from leaking past the heater.

C5.1.4.5 For each potential nozzle combination, at least one Test of a previously run airflow rate shall be retested with the blower energized.

C5.1.4.6 For each potential nozzle combination, at least one Test of a previously run airflow rate shall be retested with one bank of electric heaters turned off and one bank on.

Nozzle Delta P is limited between 0.6 and 3.0 inches of water column at Nozzle Plate		Target Nozzle Delta P*	Target DT	Nozzle Dia 1	Nozzle Dia 2	Nozzle Dia 3	Nozzle Dia 4	Nozzle Dia 5	Static Press Across Nozzle Plate	Static Press At Supply Inlet	Measured SCFM	Fan WATTS	Heater Watts	Total Watts	Electrical Heat BTUH Input	Delta T	Measured Sensible Capacity	Sensible Capacity	Heat Balance	Barometer
		~0.8	12																	
		~1.8	12																	
		~2.8	12																	
		~0.8	12																	
		~1.8	12																	
		~2.8	12																	
		~0.8	12																	
		~1.8	12																	
		~2.8	12																	

* Typical values required to evaluate full range of operation.

Table C1: Nozzle Combination Tests

C5.1.5 *Data to Collect.*

C5.1.5.1 The following data is the minimum to be collected for each test performed:

B_{SH}	=	Sensible heat energy balance, percent
E_i	=	Power input, indoor, W
E_h	=	Electric heat module power input, W
E_t	=	Power input total, W
L/S	=	Instrument induced latent to sensible capacity ratio, q_{li}/q_{shi}
P_a	=	Pressure, barometric, in Hg
P_n	=	Pressure at nozzle throat, in H ₂ O
P_v	=	Velocity pressure at nozzle throat or static pressure difference across the nozzle, in H ₂ O
R^2	=	Coefficient of determination
t_{a1}	=	Temperature, air entering indoor side, dry bulb, °F
t^*_{a1}	=	Temperature, air entering indoor side, wet bulb, °F
t_{a2}	=	Temperature, air leaving indoor side, dry bulb, °F
t^*_{a2}	=	Temperature, air leaving indoor side, wet bulb, °F
$t_{g(1-9)}$	=	Leaving grid individual thermocouples 1 through 9, °F
t_n	=	Nozzle temperature (if different than t_{a2}), °F
q_{li}	=	Instrument induced latent capacity, indoor, Btu/h
q_{shi}	=	Sensible heating capacity, indoor, Btu/h
q_{sri}	=	Electric heat module capacity, Btu/h
Q_i	=	Measured airflow, indoor, ACFM
Q_S	=	Measured airflow, scfm
Q_t	=	Target nozzle airflow rate, scfm
v'_n	=	Specific volume of air at the nozzle, ft ³ /lbm of air-water vapor mixture
Δt_a	=	Actual differential temperature, °F
Δt_t	=	Target differential temperature, °F

C5.1.5.2 The following data is the minimum to be collected for each nozzle chamber, for validation of conformance with Section 6.2, Section 6.3 and Figure 5 of ANSI/ASHRAE Standard 37:

$D_{1x,y}$	=	Distance from center of 1 st nozzle to inside edge of nozzle chamber, in both horizontal (x) and vertical (y) directions., in
$D_{2x,y}$	=	Distance from center of 2 nd nozzle to inside edge of nozzle chamber, in both horizontal (x) and vertical (y) directions., in
$D_{3x,y}$	=	Distance from center of 3 rd nozzle to inside edge of nozzle chamber, in both horizontal (x) and vertical (y) directions., in
$D_{4x,y}$	=	Distance from center of 4 th nozzle to inside edge of nozzle chamber, in both horizontal (x) and vertical (y) directions., in
$D_{5x,y}$	=	Distance from center of 5 th nozzle to inside edge of nozzle chamber, in both horizontal (x) and vertical (y) directions., in
$D_{i,j}$	=	Distance from center of nozzle i to center of nozzle j , in
D_1	=	1 st nozzle throat diameter for current nozzle combination, in*
D_2	=	2 nd nozzle throat diameter for current nozzle combination, in*
D_3	=	3 rd nozzle throat diameter for current nozzle combination, in*
D_4	=	4 th nozzle throat diameter for current nozzle combination, in*
D_5	=	5 th nozzle throat diameter for current nozzle combination, in*

* The nozzle diameter reported is the average of four separate nozzle throat diameter measurements (refer to ANSI/ASHRAE 37 Section 5.3.3).

C5.1.5.3 A data input template is located in Appendix C.

C5.1.6 *Interpretation and Application of the Data.*

C5.1.6.1 *Sensible Cooling Capacity Energy Balance.* B_{SH} , the Sensible Cooling Capacity energy balance, is defined as follows:

$$B_{SH} = \frac{q_{sri} - q_{thi}}{q_{sri}} \cdot 100 \quad C1$$

Where;

q_{thi} = Sensible capacity as calculated in ASHRAE Standard 37 (7.3.4.1)

If blower is not powered then q_{sri} is calculated as follows,

$$q_{sri} = E_h \cdot 3.412 \quad C2$$

If blower is powered then q_{sri} is calculated as follows,

$$q_{sri} = (E_i + E_h) \cdot 3.412 \quad C3$$

C5.1.6.2 *Application of Code Tester Correction Factors.* Each nozzle combination selection shall be evaluated per Section C5.1.4 with at least three unique airflow rates with the indoor blower off.

C5.1.6.2.1 If the energy balance, B_{SH} , for each airflow rate tested with a given nozzle combination is within $\pm 2.0\%$ then no nozzle combination airflow rate correction is required.

$$C_{nz} = 1 \quad C4$$

Where:

C_{nz} = Nozzle correction factor

C5.1.6.2.2 If the energy balance, B_{SH} , for each airflow rate tested with a given nozzle combination falls between either -2.1% and -4.0% or $+2.1\%$ and $+4.0\%$ then a nozzle combination airflow rate correction factor shall be assigned to that particular nozzle combination in that particular Room.

C5.1.6.2.2.1 If a first order trend line reasonably matches the data ($R^2 \geq 0.5$) and the slope is less than $0.0025\%/SCFM$ the correction shall be a single value at the mean of the test heat balances.

$$C_{nz} = 1 + (B_{SH} / 100) \quad C5$$

Where:

C_{nz} = Nozzle correction factor

$R^2 = 1 - (SS_{Residual} / SS_{Total})$

SS = Sum of the squares of the curve fit errors

C5.1.6.2.2.2 If a first order trend line reasonably matches the data ($R^2 \geq 0.5$) and the slope is greater than $0.0025\%/SCFM$ the correction shall be a first order equation with respect to the calculated airflow rate. This is not an iterative process.

$$C_{nz} = 1 + ((A + BQ_s) / 100) \quad C6$$

Where:

A = Intercept constant from first order trend line

B = Slope constant from first order trend line

C_{nz} = Nozzle correction factor

C5.1.6.2.2.3 If the first order trend line does not reasonably match the data ($R^2 < 0.5$) then a repeat of Section C5.1.4 shall be required.

If the retest demonstrates that the data is not repeatable (any retested point more than 1% different from the previously tested point) then the nozzle combination is disallowed from rating tests. Other combinations can be qualified to cover the disqualified range of airflows. No Laboratory Certification Tests shall be performed with a disqualified or un-calibrated nozzle combination.

C5.1.6.2.2.4 The instrument induced latent capacity shall be calculated using ANSI/ASHRAE Standard 37 Section 7.3.3.1. The value shall be reported and the Instrument Induced Latent/Sensible Cooling Capacity Ratio shall be calculated, L/S, and reported as a percentage. If this ratio exceeds 5% an investigation into the humidity measurement error should take place.

C5.1.6.2.2.5 No correction, either single or equations shall be allowed that exceeds a 4% correction. Nozzle combinations that have a B_{SH} greater than 4.0% shall not be used during Laboratory Certification Tests

C5.1.6.2.3 Corrective actions such as adding baffles, replacement or rearrangement of nozzles, or correction of instrumentation problems are acceptable practices. Any modification requires that Section C5.1.4 tests be re-run for all nozzle combinations and the analysis in this section be performed on the new test data.

C5.1.6.2.4 For the test where half of the heater banks is turned off and half is turned on, any of the nine grid thermocouples shall meet the following criteria (refer to ANSI/ASHRAE Standard 116 Section 7.4.3.4.2):

$$t_{g(1-9)} = t_{gaverage} \pm 0.75 \text{ } ^\circ\text{F} \tag{C7}$$

C5.1.6.2.5 For all Laboratory Certification Tests, airflow rates used in all calculations shall be with Q_{SC} substituted in place of Q_s or Q_{mi} , as appropriate.

$$\begin{aligned} Q_{mi} &= 775.9 \cdot (C_{nz} \cdot C) \cdot A_n \sqrt{2P_V v'_n} \\ &= 1097 \cdot (C_{nz} \cdot C) \cdot A_n \sqrt{P_V v'_n} \end{aligned} \tag{C8}$$

$$Q_{SC} = Q_s \cdot C_{nz} \tag{C9}$$

or

$$Q_{SC} = Q_{mi} \cdot C_{nz} \tag{C10}$$

Where:

Q_{SC} = Corrected airflow rate

C5.1.7 *Reporting and Retention of the Data.* All data identified in Section C5.1.5 and all calculations in Section C5.1.6 shall be reported for each test. Data shall be retained for a minimum of seven years.

C5.2 *Evaluation of Thermal Energy Storage Effect for C_D Testing.*

C5.2.1 *Purpose of the Test.* This Thermal Energy Storage Effect Test measures the thermal energy storage of the airflow rate measuring apparatus in order to accurately determine the cyclic capacity of the dry coil as specified in Section 9.2 of ANSI/ASHRAE Standard 116 (e.g. the Cyclic Test for Single Stage System in AHRI Standard 210/240).

C5.2.2 *Selection of Equipment.*

C5.2.2.1 *Equipment Classification.* The UUT for the Thermal Energy Storage Effect Test shall be the same split system Air Handler with electric heat capability used in Section C5.1 or the purpose built heater box.

C5.2.2.2 *Equipment Size and Configuration.* The production equipment design shall be fitted with an electric heat module of at least 2 kW per maximum cooling ton located at the outlet of the Air Handler. A purpose built heater box with the same electrical specification may be used. The UUT wiring shall be modified so that electrical energy supplied to the heater may be varied separately from electrical energy supplied to the rest of the UUT. Typically, the psychrometric Outdoor Room power supply and measurement equipment will need to be used due to relatively high power requirements. Individual banks shall have the capability of being switched ON and OFF independently.

C5.2.3 *Test Setup.*

C5.2.3.1 The UUT shall be set up in the Indoor Room in accordance with ANSI/ASHRAE Standard 37 Section 6.4 through Section 6.6.

C5.2.3.2 All indoor electrical energy shall be measured with instrumentation which is in accordance with Section 5.4 of ANSI/ASHRAE Standard 37.

C5.2.3.3 If an indoor volatile refrigerant coil is present in the UUT it shall be void of refrigerant charge in order to eliminate any thermal siphoning.

C5.2.3.4 The leaving thermocouple grid (or thermopile) must not be affected by the radiant energy coming from the heater element. Verified by the following:

C5.2.3.4.1 Set the room temperature to 90°F. Run the air through the apparatus with no electric heat energized and record the difference in temperatures between the leaving grids and RTDs in the psychrometers (four independent readings shall be taken).

C5.2.3.4.1.1 For thermocouple grids or thermopiles, set the room temperature to 70 °F. Apply power to the heater to raise the air temperature approximately 20 °F. If the difference between the grids and the RTDs vary by more than 1 °F, then shield or block the line of sight between the heater and thermocouples.

C5.2.3.5 At least one thermocouple shall be attached via solder method per ANSI/ASHRAE Standard 41.1 Section 7.2.10; or mechanically attach thermocouples to each potential large thermal mass between the outlet of the UUT and the grid of thermocouples specified in Section C5.2.3.4. Thermocouples shall be connected in parallel.

C5.2.4 *Running the Test Procedure.*

C5.2.4.1 The indoor blower motor shall be left unpowered throughout this Thermal Energy Storage Effect Test.

C5.2.4.2 Indoor air inlet conditions shall be maintained at 70.0 ±0.5 °F dry-bulb temperature and 65.0 ±0.3 °F wet-bulb temperature.

C5.2.4.2.1 The Test Operating Tolerance for dry-bulb temperature shall not exceed 0.5°F and for wet-bulb temperature shall not exceed 0.3 °F during the test.

C5.2.4.3 The airflow shall be set to 1,200 scfm and shall be maintained continuous throughout the test. The heater shall be powered to produce between 8 and 10 kW. The heater shall be cycled ON for 6 minutes then OFF for 6 minutes. Ten ON/OFF cycles (2 hours) shall constitute a complete test.

C5.2.4.4 Care shall be taken to assure the voltage to the heater remains constant at the level of the test described in Section C5.2.4.3. It is highly recommended that the active variac voltage control be disabled during the cyclic part of this test.

C5.2.4.5 The thermocouple or thermocouples attached to the largest thermal mass in the test facility, out of line of sight of the heater, shall be recorded on a minimum of ten-second intervals for the duration of the six-minute ON time. Note that if more than one large thermal mass is expected, then the temperature shall be monitored on each expected large thermal mass and proceed with calculations based on the experimentally determined largest thermal mass.

C5.2.5 *Data to Collect.*

C5.2.5.1 The following data is the minimum to be collected for Thermal Energy Storage Effect testing:

All of the data from Section C5.1.5 and the following additional data:

- t_m = Thermal mass of assembly, °F
- $t_m(0)$ = Temperature of largest thermal mass between the UUT and the measurement grid (likely the mixer) at the start of the OFF cycle, °F
- $t_m(\Theta_t)$ = Temperature of largest thermal mass between the UUT and the measurement grid (likely the mixer) at end of the integration time within the OFF cycle, °F
- $q_{cyc,h}$ = Integrated capacity based on the measured power of the heater, Btu/h
- $q_{cyc,hoff}$ = Integrated capacity based on the measured power of the heater during an off cycle, Btu/h
- q_{ts} = Cyclic thermal storage capacity correction, Btu/h
- mc_{pm} = Mass times the specific heat of the thermal storage device per ANSI/ASHRAE Standard 116, Section 9.2.2, Btu/°F

C5.2.6 *Interpretation and Application of the Data.*

Specifically, this Thermal Energy Storage Effect Test is measuring q_{ts} and the integrated thermal mass change in temperature of the cyclic cooling or heating capacity per ANSI/ASHRAE Standard 116 Section 9.2.2 to determine the mc_{pm} term.

C5.2.6.1 Since Thermal Energy Storage Effect Test is being performed with electric heaters as the source of capacity and electric heaters for all practical purposes are instantly ON, the OFF cycle integrated capacity (Btu/h) is the measure of heat storage in the thermal mass. Therefore:

$$q_{ts} = q_{cyc,hoff} \tag{C11}$$

C5.2.6.2 The integrated change in temperature of the thermal mass, from the beginning of the Thermal Energy Storage Effect test to the end of the six-minute ON cycle shall be considered thermal storage potential.

C5.2.6.3 Record the integrated cyclic single or multiple thermocouple average temperature, representative of the bulk temperature of the largest thermal mass of the test equipment (usually the mixer).

C5.2.6.4 Determine mc_{pm} from ANSI/ASHRAE Standard 116 Sections 7.4.3.4.5, and 9.2.2, for each of the last 6 to 8 cycles.

$$mc_{pm} = q_{ts} / [t_m(0) - t_m(\Theta_t)] \tag{C12}$$

C5.2.6.5 Report mc_{pm} as the mean of mc_{pm} for last 6 to 8 cycles. Cycle equilibrium is defined in ANSI/ASHRAE Standard 116 Section 8.2.4.2 as three consecutive cycles in which the integrated ΔT for the ON portion of the cycle does not vary by more than 0.3°F and the total watts for the complete ON/OFF cycle does not vary by more than 10 watts.

C5.2.6.6 For mc_{pm} less than or equal to 4.0 Btu/°F no adjustments to cyclic data is required. For mc_{pm} greater than 4.0 Btu/°F, thermocouples shall remain on the device with the greatest thermal energy storage effect and adjustment made to all cyclic Laboratory Certification Test as per ANSI/ASHRAE Standard 116 Section 9.2.2 and 9.2.3.

C5.2.6.7 *Example of data reporting.*

Time Stamp, s	Temp Entering Grid, °F	Temp Leaving Grid, °F	Airflow, scfm	Specific Heat, BTU/lbm _{da} -°F	Specific Volume, ft ³ /lbm _{da}	Heater Power, W	Air Measured Capacity, Btu/h	Mass Temp, Btu/h-°F
3590	70	90	1200	0.2405	0.075	8000	25974	90
3600	70	90	1200	0.2405	0.075	0	25974	89.9
3610	70	89.5	1200	0.2405	0.075	0	25325	89.8
3620	70	89	1200	0.2405	0.075	0	24675	89.7
7180	70	70.2	1200	0.2405	0.075	0	259	71.2
7190	70	70.1	1200	0.2405	0.075	0	129	71.0
Average							2435	

Calculate $mc_{pm} = \text{Air Measured Capacity (Average)} / (\text{Mass Temperature at Start of OFF Cycle} - \text{Mass Temperature at End of OFF Cycle}) \cdot (6 \text{ minutes}/60 \text{ minutes}/\text{Hr})$

$$mc_{pm} = 2435 / (89.9 - 71.0) \cdot 0.1 = 12.88 \quad \text{C13}$$

C5.2.7 Reporting and Retention of the Data.

All data identified in Section C5.2.5 shall be saved in a spread sheet reporting both the steady state test and cycles 2 through 5 of the Cyclic Test. Data shall be retained for a minimum of seven years.

C5.3 *Evaluation of External Static Pressure Measurement System.*

C5.3.1 *Purpose of the Test.* The External Static Pressure Measurement test compares the external static pressure measurement instrumentation to a known passive pressure drop device, comparing ANSI/ASHRAE Standard 37 duct configurations to ANSI/ASHRAE Standard 116 duct configurations, in order to validate that ANSI/ASHRAE Standard 116 duct configurations provide accurate external static pressure measurements.

C5.3.2 Selection of Equipment.

C5.3.2.1 *Equipment Classification.* A passive pressure drop device is a box with nominal outside dimensions approximating a Cased Coil (see Table C2 and Figure C1 below). It shall be constructed with fixed restrictor plates to simulate the pressure drop associated with an indoor coil at nominal airflows. An outlet duct shall be sized according to ANSI/ASHRAE Standard 37 Section 6.4.4 and shall be used to measure the outlet pressure.

C5.3.2.2 *Equipment Size and Configuration.* The passive pressure drop device cabinets shall be constructed without internal insulation and shall be sealed to prevent any external or internal air leakage. The cabinets shall be fitted with a fixed restrictor plate in the position of the coil condensate pan. Each restrictor plate has been developed with an opening size to create 0.30 in H₂O external static pressure with a tolerance of ±0.02 in H₂O at 1200 scfm.

Cabinet	Width, in	Depth, in	Minimum Height, in	Nominal Airflow Test Points, scfm						
				600	800	1000	1200	1400	1600	1800
B	17.5	21	24							
Static Pressure – Standard				1	1	1	.30	1	1	1
Notes:										

1. To be recorded at each airflow (in H₂O)

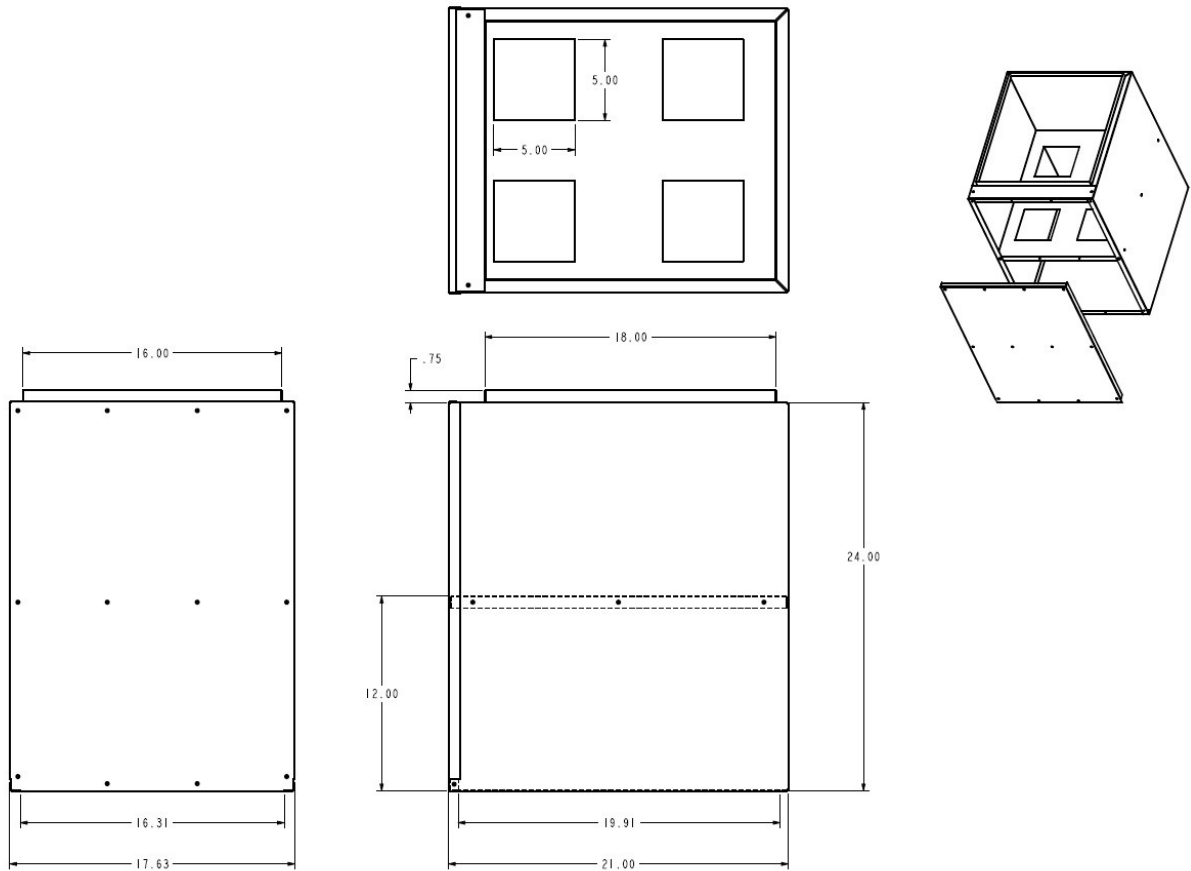

Figure C1. Passive Pressure Drop Device

Refer to Figure 8 in ANSI/ASHRAE Standard 37 for inlet and outlet duct dimensions.

C5.3.3 Test Setup.

C5.3.3.1 The passive pressure drop device shall be set up in accordance with ANSI/ASHRAE Standard 37 Section 6.4 through Section 6.6, except as noted below in Section C5.3.3.2.

C5.3.3.2 The passive pressure drop device shall be tested in all of the following configurations:

C5.3.3.2.1 *Exact ASHRAE Duct Configuration Baseline.* Per ANSI/ASHRAE Standard 37 Section 6.4.4, the passive pressure drop device shall be set up with an entering and leaving duct with the dimensions outlined in Figure 8 of ANSI/ASHRAE Standard 37. The entering duct shall have free flow of air and shall not be on top of a bottom damper system employed for Cyclic Testing.

C5.3.3.2.2 *Conventional Psychrometric Testing Configuration.* This testing shall utilize the bottom damper system and whatever means (pressure skirt with four manifolded pressure taps on top of the damper, entering ASHRAE duct, etc.) the Laboratory Facility utilizes for measuring inlet air pressure to the UUT. The outlet duct between the upper damper and the outlet of the UUT shall be whatever conventional configuration that will be utilized by the test facility for certification testing.

C5.3.3.2.3 *Height Constrained Psychrometric Testing Configuration.* If the Laboratory Facility has height constraints when testing equipment with the full outlet

ASHRAE ducts, then whatever alternate configuration the Laboratory Facility may utilize to measure these systems shall also be tested to validate against the setup in Section C5.3.3.2.1.

C5.3.4 *Running the Test Procedure.*

C5.3.4.1 Indoor air inlet conditions shall be those specified for the A test in AHRI Standard 210/240 Section 6.1 Table 7. Tolerances shall also be per AHRI Standard 210/240.

C5.3.4.2 Run each nominal standard airflow rate in Table C2 using only qualified nozzle combinations for each of the configurations identified in Section C5.3.3.2 above. Airflow rate shall be set to the test point and the measured reading shall be within ±1% of the airflow rate set point, as specified in Table C2.

C5.3.4.3 Test data for each point shall be recorded at equal intervals, with a maximum interval period of one minute, over a 30-minute period. Data shall be averaged. For each set of test data, there shall be a 30-minute pre-conditioning time.

C5.3.5 *Data to Collect.*

C5.3.5.1 The following data is the minimum to be collected for this testing:

- B_{ST} = Static pressure drop balance, percent
- P_a = Pressure, barometric, in Hg
- P_n = Pressure at nozzle throat, in H₂O
- P_v = Velocity pressure at nozzle throat or static pressure difference across the nozzle, in H₂O
- Q_s = Measured airflow rate, scfm
- t_{a1} = Temperature, air entering indoor side, dry bulb, °F
- t_{a1}^* = Temperature, air entering indoor side, wet bulb, °F
- t_n = Nozzle temperature (if different than t_{a2}), °F
- ΔP_{stA} = Actual pressure drop, in H₂O
- ΔP_{stC2} = Table C2 pressure drop, in H₂O

C5.3.5.2 A data input template is located in Appendix.

C5.3.6 *Interpretation and Application of the Data.*

C5.3.6.1 Static pressure drop balance shall be calculated using the following formula:

$$B_{ST} = \frac{\Delta P_{stA} - \Delta P_{stC2}}{\Delta P_{stC2}} \cdot 100 \tag{C14}$$

C5.3.6.2 The external static pressure balance B_{ST} for each airflow rate shall be within ±7% of the calibrated restrictor plate.

C5.3.6.3 If B_{ST} is not within ±7%, then the code tester, instrumentation, etc. shall be evaluated and improvements made to the facility to bring it into compliance. All tests in Table C2 shall be re-run after any changes have been made.

C5.3.6.3.1 If there are problems meeting this tolerance, then it is recommended that Laboratory Facility run with the entering ASHRAE duct with the outlet configuration that did not meet the tolerance, and then repeat the tests with the ASHRAE outlet configuration and the inlet configuration that failed to meet the tolerance in order to isolate which portion of the external static pressure measurement apparatus is out of tolerance.

C5.3.6.4 All Laboratory Certification Tests shall be performed only in Psychrometric Test Facilities that have been verified to have B_{ST} less than ±7%.

C5.3.7 *Reporting and Retention of the Data.*

All data identified in Section C5.3.5 and calculated in Section C5.3.6 shall be reported for each run, and shall be retained for a minimum of seven years.

C5.4 *Full System Psychrometric Round Robin Testing.*

C5.4.1 *Purpose of the Test.* The purpose of the Full System Psychrometric Round Robin Testing is to verify that all Psychrometric Test Facilities that may be used by a Laboratory yield consistent results. Authorized Laboratory Facilities shall be required to perform this Round Robin Testing on an annual basis.

C5.4.2 *Selection of Equipment.*

C5.4.2.1 *Equipment Classification.* In order to qualify the Laboratory Facility for both cooling and heating, a Single Stage Heat Pump shall be selected from the categories identified in Table 2 of AHRI Standard 210/240. Initial testing preference would be given to either a Split System (HRCU-A-CB) or a Single Package Heat Pump (HSP-A). For repeat Round Robin Testing, other types of systems shall be selected.

C5.4.2.2 *Equipment Size and Configuration.* The system to be tested shall be selected from the AHRI USE Certification Program samples previously tested at an existing Authorized Laboratory Facility operating under contract with AHRI. The selected audit system shall be an OEM system and shall have passed all certified values with at least 95% of the Certified Rating and if a Split System, be within $\pm 10\%$ on all condenser curves per the AHRI USE OM. The system type shall be a simple base model without proprietary controls or other features that would complicate the testing. The Nominal Capacity of the initial system would preferably be 3 tons. The size of the round robin system shall be rotated on a yearly basis to ensure the entire application range is covered.

C5.4.3 *Test Setup.*

Contact with the equipment manufacturer is permitted, and preferred, to validate correct set up prior to conducting any Tests.

C5.4.3.1 *Test System Preparation/Charge.* If the system is not pre-charged (e.g. a Split System), during the cooling Tests the UUT shall be charged to match the previous audit data. In order to match operating conditions, the refrigerant charge may be adjusted once during the heating H1 Tests to match the outdoor subcooling results of the existing Authorized Laboratory Facility if refrigerant subcooling leaving the condenser is greater than 1 °F different from the subcooling value during the baseline test. The difference in charge, if any, shall be recorded in each case.

C5.4.3.2 *Test System Preparation/Cyclic.* Cyclic Testing shall be conducted using the same time delays as used during the baseline testing, and shall use the mc_{pm} determined in Section C5.2.6.

C5.4.3.3 *Secondary Capacity Check Type.* For Split Systems, the preferred secondary energy balance is the refrigerant enthalpy method as outlined in ANSI/ASHRAE Standard 37 Section 7.5. For Single Package Units, the preferred secondary energy balance is the outdoor air enthalpy method as outlined in ANSI/ASHRAE Standard 37 Section 7.3. If the psychrometric rooms are capable of both methods, then both energy balances should be collected during the testing of a Split System.

C5.4.4 *Running the Test Procedure.*

C5.4.4.1 Each Room in which the Laboratory Facility may use for AHRI 210/240 performance Tests shall undergo the full battery of tests outlined below with the same round robin system:

C5.4.4.1.1 *AHRI Standard 210/240 Tests.* The full set of tests from AHRI Standard 210/240 Table 7 as appropriate shall be performed. Cyclic Tests shall be performed.

C5.4.4.1.2 *Evaluation of Latent Capacity Measurement.* See Section C5.5 for full details. These tests shall be run at the same time as the steady state cooling Tests from Section C5.4.4.1.1.

C5.4.5 *Minimum Data Collection Requirements.*

C5.4.5.1 All data required by ANSI/ASHRAE Standard 37 Section 9 shall be required for all Tests in Section C5.4.4. SEER and HSPF shall be determined using the bin method only.

C5.4.5.2 In addition, all data identified in Section C5.5.4 shall be collected to evaluate the latent capacity measurement.

C5.4.6 *Interpretation and Application of the Data.*

C5.4.6.1 In order to be qualified as an Authorized Laboratory Facility, the following criteria must be met:

C5.4.6.1.1 Each individual measured value (cooling capacity, heating capacity, SEER and HSPF) shall be within 2% of the mean of all individual measured values.

C5.4.6.1.2 The latent capacity balance shall be within the tolerances specified in Section C5.5.6 of this appendix.

C5.4.6.1.3 System state points shall be within:

C5.4.6.1.3.1 5 psig for any high-side pressure

C5.4.6.1.3.2 2 psig for any low-side pressure

C5.4.6.1.3.3 1°F superheat at charging location (for piston expansion systems)

C5.4.6.1.3.4 1°F subcooling at charging location (for expansion valve systems)

Any questions on the testing process shall be referred to the AHRI Unitary Small Equipment Engineering Committee.

C5.4.7 *Reporting and Retention of the Data.*

All data and results identified in Sections C5.4.5 and C5.4.6 shall be reported for each test. Data and results shall be retained for a minimum of seven years. All round robin test data shall be reported in both the laboratory standard report format, as well as XML format (if available), as required by the AHRI USE Operations Manual.

C5.5 *Evaluation of Latent Capacity Measurement.*

C5.5.1 *Purpose of the Test.* This test compares the psychrometric calculated latent capacity against the calculated latent capacity using the measurement of condensate draining from the indoor coil of the system. This is to provide a Laboratory Facility the ability to validate that its psychrometric measurement apparatus can measure the latent capacity within 5% of the actual condensed water removed from the airstream by the indoor coil.

C5.5.2 *Selection of Equipment.*

C5.5.2.1 The equipment for latent capacity measurement is the same as that required previously by Section C5.4.2.

C5.5.3 *Test Setup.*

C5.5.3.1 ANSI/ASHRAE Standard 37 Section 7.8 outlines a method for calculating the latent capacity based on the mass flow rate of the cooling condensate draining from the indoor coil for equipment with a rated capacity of 135,000 Btu/h or higher that use an indirect method for

determining airflow rate. This appendix shall apply the same methodology to equipment with a rated capacity of 65,000 Btu/h or less with a direct measurement of airflow rate.

C5.5.3.2 The required setup for running the latent capacity test is to connect tubing between the condensate drain on the indoor coil and a secondary reservoir. A drain trap shall be used in the tubing between the outlet of the condensate pan and the secondary reservoir. The drain trap shall be installed per the Installation Instructions. The secondary reservoir shall be placed upon a scale capable of measuring weight to the nearest 0.01 lb or shall be a container capable of measuring volume to the nearest 0.1 oz.

C5.5.4 *Running the Test Procedure.*

C5.5.4.1 The Tests required in Sections C5.1 through C5.3 of this appendix shall be performed prior to the latent capacity testing.

C5.5.4.2 The blower fan speed shall be set to the lowest Airflow-control Setting.

C5.5.4.3 The system shall be run at the A_{Full} condition except as noted in Section C5.5.4.2 for at least five consecutive A tests during the cooling Tests of the full system psychrometric round robin testing (see Section C5.4).

C5.5.4.4 The condensate mass flow rate draining off of the indoor coil shall be measured during each of the five consecutive A_{Full} Tests.

C5.5.4.4.1 At a minimum, measure the weight or volume at the beginning and at the end of each individual A_{Full} Test. Calculate the difference and divide it by the total time (0.5 h in this case) to obtain the condensate mass flow rate.

C5.5.4.4.2 A preferred method is to connect the scale to the lab’s data acquisition system to log the data for the entire A_{Full} Test. The reservoir shall be emptied as needed between tests to avoid overflowing.

C5.5.4.4.3 If the condensate mass flow rates from the last three A_{Full} Tests meet the requirements of Section C5.5.6.3, then the Latent Capacity Measurement testing is complete. If the requirements are not met, then either a) adjustment to or re-calibration of the Laboratory Facility equipment shall be performed, or b) consecutive A_{Full} Tests shall be continued until the requirement is met, with a maximum of ten consecutive Tests. Any and all tests required by this Standard that may potentially have been affected by adjustments or re-calibration shall be re-run.

C5.5.5 *Minimum Data Collection Requirements.*

C5.5.5.1 All of the data from Section C5.4.5 and the following additional data shall be recorded:

- w_c = Condensate mass flow rate, lbm/h
- B_{LC} = Latent capacity energy balance, percent

C5.5.6 *Interpretation and Application of the Data.*

C5.5.6.1 Calculate the latent capacity based on the measured condensate flow rate:

$$q_{lcc} = 1061 \cdot w_c \tag{C15}$$

Where:

- q_{lcc} = latent capacity based on condensate flow, Btu/h
- w_c = Condensate mass flow rate, lbm/h

C5.5.6.2 Calculate the latent capacity balance based on the measured condensate flow rate:

$$B_{ST} = \frac{q_{lcc} - q_{lci}}{q_{lcc}} \cdot 100 \quad \text{C16}$$

C5.5.6.2 The absolute value of B_{LC} for each of the last three A_{Full} tests shall not be greater than 5%.

C5.5.6.2.1 If the latent capacity balance between the psychrometric and the measured condensate are outside of these tolerances it could possibly indicate a psychrometer inaccuracy issue (either control or measurement) or a mixing issue that would require improvements to the facility. If changes are made to any test apparatus, set-up or calibration, this battery of tests shall be re-run in their entirety.

C5.5.6.3 In addition, the latent capacity (q_{lcc}) based on condensate flow for each of the last three consecutive A_{Full} tests shall be within $\pm 6\%$ of each other to verify the repeatability of the facility.

C5.5.7 *Reporting and Retention of the Data.*

All data and results identified in Sections C5.4.5 and C5.4.6 shall be reported for each test. Data and results shall be retained for a minimum of seven years. All round robin test data shall be reported in both the laboratory standard report format, as well as XML format (if available) as required by the AHRI USE Operations Manual.

APPENDIX D. SECONDARY CAPACITY CHECK REQUIREMENTS - NORMATIVE

D1 Purpose. The purpose of this appendix is to specify requirements for the outdoor air enthalpy and refrigerant enthalpy secondary capacity checks.

D2 Scope.

D2.1 The requirements of this appendix shall apply to all testing of:

D2.1.1 Unitary Small Air-Conditioners which are air-cooled.

D2.1.2 Unitary Small Air-Source Heat Pumps which are air-cooled.

D2.2 The requirements of this appendix are not applicable to Water-cooled or Evaporatively-cooled Air-conditioners.

D3 Definitions.

D3.1 Code Tester. A nozzle airflow measuring apparatus as defined by ANSI/ASHRAE Standard 37 Section 6.2.

D3.2 Flow Meter Assembly. A mass flow meter and associated tubing, valve assemblies, sight glasses and/or other components used to measure refrigerant mass flow rate but that add internal volume to the operating system.

D3.3 Pressure Transducer Assembly. A pressure transducer and associated tubing, valve assemblies, and/or other components used to measure refrigerant pressures but that add internal volume to the operating system.

D4 Symbols.

D4.1 q_{tia} = Total capacity, indoor, air, Btu/h

D4.2 q_{tir} = Total capacity, indoor, refrigerant, Btu/h

D4.3 q_{toa} = Total capacity, outdoor, air, Btu/h

D4.4 For Coil-only Systems, total capacity as defined in D4.1, D4.2 and D4.3 shall be Gross Capacity.

D4.5 For applications having a blower motor, total capacity as defined in D4.1, D4.2 and D4.3 shall be defined as Net Capacity.

D4.6 HB = heat balance = $\frac{(q_{tia}-q_{tir})}{q_{tia}}$ or $\frac{(q_{tia}-q_{toa})}{q_{tia}}$

D5 Requirements.

D5.1 Usage of Refrigerant Mass Flow Method.

D5.1.1 All Split Systems, whether ducted or non-ducted, shall use the refrigerant mass flow method as the secondary capacity check.

D5.1.1.1 Excluded from Section D5.1.1 requirements is any Split System with an expansion device located upstream of the liquid line mass flow meter (i.e. systems with a cooling expansion device in the Outdoor Unit).

D5.1.1.2 This method shall not be used on specific tests if ANSI/ASHRAE Standard 37 Section 7.5 cannot be met. The air enthalpy method shall be substituted in these cases.

D5.1.2 The absolute value of HB shall be 4.0% or less on all steady state tests utilizing the refrigerant mass flow method, except for H3 or any inverter at other than full speed which is exempt from this requirement if:

D5.1.2.1 The absolute values of HB for Tests B_{Full} and H1_{Full} are 3.0% or less, and

D5.1.2.2 The subcooling leaving the Indoor Unit is less than 3.0 °F.

~~**D5.1.3** Excluded from Section D5.1.1 requirements is any Split System with an expansion device located upstream of the liquid line mass flow meter (i.e. systems with a cooling expansion device in the Outdoor Unit).~~

~~D5.1.4~~ This method shall not be used on specific tests if ANSI/ASHRAE Standard 37 Section 7.5 cannot be met. The air enthalpy method shall be substituted in these cases.

D5.2 *Usage of Outdoor Air Enthalpy Method.*

D5.2.1 All Single Package Units shall use the outdoor air enthalpy method as the secondary capacity check.

D5.2.1.1 The absolute value of HB shall be 6.0% or less on all tests, except for H3 which is exempt from this requirement if the absolute values of HB for all other tests are 6.0% or less.

D5.3 The first Steady State Test in each mode (cooling and/or heating) shall have a secondary capacity check completed. For all other tests in each mode, it is permissible to not use a secondary capacity check.

D6 *Refrigerant Mass Flow Method Requirements.*

D6.1 *Pressure Measurement Requirements.*

D6.1.1 Pressure measurements shall be taken at the indoor coil, per ANSI/ASHRAE Standard 37 Section 7.5.3 and ANSI/ASHRAE Standard 41.3.

D6.1.1.1 Vapor pressures at the Outdoor Unit may be measured and used as an alternate to vapor pressure at the Indoor Unit, if required to achieve 5 °F superheat, as long as appropriate adjustments are made per Section D6.4.3.1.

D6.1.2 Taken within 12 in of the field connection of the Indoor Unit.

D6.1.3 Taken on the top half of the tube, unless the tubing is vertical, in which case any side is acceptable. Pressure taps shall be installed such that oil may not fill the pressure tap line.

D6.1.4 Made no closer than 10 tube diameters upstream or downstream of any bends that are greater than 30 degrees nor within 10 tube diameters of short radius bends. Tubing shall be inspected to verify there are no kinks or restrictions.

D6.2 *Temperature Measurement Requirements.*

D6.2.1 Temperature measurements shall be made with instrumentation according to ANSI/ASHRAE Standard 41.1.

D6.2.2 The preferred method of refrigerant temperature measurements is resistance temperature devices (RTDs) per ANSI/ASHRAE Standard 41.1 Section 7.4. If used, RTDs shall be installed with tubing arrangement such that pressure drops due to application do not exceed 0.5 psig.

D6.2.3 When thermocouples (TCs) are used for measurement of refrigerant temperature by application to the outside of tubing, the following requirements shall be met:

D6.2.3.1 The TC material used shall have special limits of error of 0.75 °F or less.

D6.2.3.2 For non-vertical tubes, the TCs shall be placed in the upper half of refrigerant tubes, as there may be oil in the lower half.

D6.2.3.3 For each liquid and vapor measurement, two TCs shall be applied within 3 in of each other, with one TC at the 10 o'clock position and one TC at the 2 o'clock position. Each TC shall be measured individually. The average of the two temperatures on each liquid and vapor line shall be used for calculations.

D6.2.3.4 Every TC shall be applied to the tubes per ANSI/ASHRAE Standard 41.1 Section 7.2. This entails ensuring that:

D6.2.3.4.1 There shall be no more than three turns of wires contacting each other;

D6.2.3.4.2 The wires shall be ‘tinned’ or soldered together before application to the tube;

D6.2.3.4.3 The wires shall be secured to the tube via soldering or welding (without burning insulation or melting wire), or thermally conductive epoxy or secure mechanical attachment;

D6.2.3.4.4 The wires outside of the joint described in Section D6.2.3.4.3 shall be prevented from touching each other or other metallic surfaces, preferably by applying electrical tape between the wire and the tube outside of the solder bed; and

D6.2.3.4.5 The wires shall have a strain relief.

D6.2.3.5 Every TC shall be applied per ANSI/ASHRAE Standard 41.1 Section 5.5.2 with insulation having an R-value of at least 3.1 that extends along the tube for at least 6 in on either side of the TC.

D6.2.4 TCs shall be applied at the exiting side of the refrigerant mass flow meter assembly. For heat pumps, this means both sides of the refrigerant mass flow meter assembly shall have TCs applied.

D6.2.5 It is preferred, but not required, that TCs be individually calibrated per ANSI/ASHRAE Standard 41.1 Section 7.2.4.

D6.3 *Refrigerant Mass Flow/Refrigerant Properties.*

D6.3.1 NIST REFPROP 9.1 or higher shall be used for refrigerant properties (saturated values and enthalpies)

D6.3.2 Refrigerant mass flow rate calculations shall account for the mass flow rate of oil in the refrigerant line, as oil contributes to the mass flow rate but not productive heat transfer.

D6.3.2.1 If oil circulation rate is not measured, a 1.0% oil circulation rate shall be assumed ($x = 0.99$).

D6.3.2.2 If the quantity of oil circulation is measured, the calculation shall follow ANSI/ASHRAE Standard 37 Section 7.5.2.3, referencing ANSI/ASHRAE Standard 41.4.

D6.3.3 Mass flow rates shall be measured by equipment meeting ANSI/ASHRAE Standard 41.10 requirements.

D6.4 *Mass Flow Procedure Requirements.*

D6.4.1 The actual internal volume of Pressure Transducer Assemblies and Flow Meter Assemblies shall be measured or calculated prior to setup and recorded with the test report data. Inside diameter and lengths of hoses or tubes, or internal volume of hoses shall be documented. This information shall be recorded along with all other test data.

D6.4.1.1 The entire length of liquid line outside of flow meter assembly connections shall be the diameter specified by the Installation Instructions.

D6.4.2 If a manufacturer specifies a refrigerant charge by weight, then charge shall be adjusted by adding the cumulative internal volume of the flow meter assemblies and pressure transducer assemblies, ft³, times the liquid density of the refrigerant, lbm/ft³, used at the charging test condition, as measured at the indoor section.

D6.4.3 Refrigerant side capacity (q_{tri}) shall be calculated per ANSI/ASHRAE Standard 37 Section 7.5.4 for cooling mode and Section 7.5.5 for heating mode.

D6.4.3.1 If vapor refrigerant at the indoor coil pressure tap is not superheated by at least 5 °F, or the liquid refrigerant at the indoor coil pressure tap is not sub-cooled by at least 3 °F, then

refrigerant properties at the Outdoor Unit may be substituted, as long as refrigerant side capacity is adjusted by line loss calculations per ANSI/ASHRAE Standard 37 Section 7.3.3.4. If the minimum superheat values are not met at the Outdoor Unit, then the outdoor air enthalpy method shall be used per Section D7 of this appendix.

D6.4.4 The following adjustments shall be made when the difference in elevation between the pressure tap location and pressure transducer is greater than one foot. The adjustment is optional for elevation differences less than one foot.

D6.4.4.1 If the pressure transducer is located higher than the pressure tap location, add the elevation head difference to the pressure transducer measurement. If the pressure transducer is located lower than the pressure tap location, subtract the elevation head difference from the pressure transducer measurement.

D6.4.5 If pressure transducers are located in the outdoor or indoor test environment, they shall be temperature compensated in accordance with the manufacturer's instrument instructions. Pressure transducer temperature range shall be suitable for the mounting location.

D7 *Outdoor Air Enthalpy Method Requirements.*

D7.1 *Pressure Measurement Requirements.*

D7.1.1 Pressure measurements shall be made with instrumentation according to ANSI/ASHRAE Standard 41.2.

D7.1.2 Refrigerant pressure measurements shall be made at the service connections provided on the product.

D7.1.2.1 Split Systems that meet the requirements of Section D5.1 shall have pressures and temperatures measured at the Indoor Unit per Section D6.1 and D6.2.

D7.1.3 Airside pressure measurements shall be taken with static pressure taps compliant with Figure 7A of ANSI/ASHRAE Standard 41.2.

D7.2 *Temperature Measurement Requirements.*

D7.2.1 Temperature measurements shall be made with instrumentation according to ANSI/ASHRAE Standard 41.1.

D7.2.2 Outdoor air inlet temperatures shall be measured with RTDs using a sampling device per Appendix E.

D7.2.3 Outdoor air outlet temperatures, when the duct is connected, shall be measured with RTDs using a sampling device per Appendix E.

D7.2.4 When thermocouples (TCs) are used for measurement of refrigerant temperature by application to the outside of tubing, the requirements of Section D6.2.3 shall be met.

D7.2.5 TCs shall be applied to the condenser coil tubing halfway between the vapor connection and the liquid connection of the individual circuit, in two separate locations, in order to determine saturation temperature at the midpoint of the circuit.

D7.2.6 It is preferred, but not required, that TCs be individually calibrated per ANSI/ASHRAE Standard 41.1 Section 7.2.4.

D7.3 *Fan Motor Properties.*

D7.3.1 Fan speed measurements, when measured, shall be taken with an instrument accurate to ± 1 rpm.

D7.3.2 Fan current, when measured, shall be taken with an ammeter having an accuracy of 2.0%, or better, of the fan motor current being measured.

D7.3.3 Fan power, when measured, shall be taken with an instrument having accuracy of 2.0% or better of the fan motor power being measured.

D7.4 *Airflow Rate/Air Properties.*

D7.4.1 Airflow rate shall be measured using a code tester per ANSI/ASHRAE Standard 37, Section 6.2.

D7.4.2 Any code tester used shall have completed Section 5.1 of the LEAP.

D7.4.2.1 Any correction factors used from the LEAP evaluation process shall be recorded on the final test report.

D7.4.3 Air properties shall be calculated per the ASHRAE Fundamentals Handbook, using measurements of properties as specified in this appendix.

D7.5 *Ductwork.*

D7.5.1 For units that discharge air completely vertically or completely horizontally, the inside dimensions of the duct including insulation shall be at least 6 in greater than the corresponding dimensions for the discharge air opening of the unit. Additionally, the duct shall be centered over the discharge air opening. The following exceptions apply:

D7.5.1.1 For units that have air outlet next to air inlet, the 6 in minimum is not required.

D7.5.1.2 For units that have air outlets next to the ground, the 6 in minimum is not required.

D7.5.1.3 For units with flanges, the duct shall be the same size as the duct flanges.

D7.5.2 For units that discharge air partially horizontally, the outside dimensions of the duct shall be at least two feet greater than the air outside diameter opening of the unit.

D7.5.3 Rectangular ducts may be used on units with round openings, and round ducts may be used on units with rectangular openings. In either case, the 6 in minimum applies, and the ducts shall be centered over the opening.

D7.5.4 For rectangular ducts, one pressure tap per side (a total of 4) shall be applied to the center of each duct face. For round ducts, four pressure taps shall be applied at 90° spacing.

D7.5.4.1 All pressure taps shall be located the same distance downstream from the discharge air opening.

D7.5.4.2 All pressure taps shall be located at a distance of at least one full length of the greatest duct dimension downstream of the discharge air opening.

D7.6 *Outdoor Air Enthalpy Calculation Procedure Requirements.*

D7.6.1 Operational mode is identified as either cooling mode or heating mode, with additional modes in either cooling mode or heating mode in which the outdoor airflow rate changes. The most common operational modes are:

D7.6.1.1 For Single Stage Systems with single speed outdoor fan:

D7.6.1.1.1 Cooling mode

D7.6.1.1.2 Heating mode

D7.6.1.2 For two stage product with two speed outdoor fan:

D7.6.1.2.1 Cooling mode high stage

- D7.6.1.2.2 Cooling mode low stage
- D7.6.1.2.3 Heating mode high stage
- D7.6.1.2.4 Heating mode low stage

D7.6.1.3 For variable speed product, each individual test per Table 7 of this standard shall be considered an operational mode.

D7.6.1.4 The independent third party lab shall work with the manufacturer to identify any other test where free air may be required.

D7.6.2 For each operational mode identified in Section D7.6.1, there shall be one free air (FA) test performed with no ductwork or attachments added to the Unit Under Test (UUT). This FA test may be conducted on any test in a given operational mode. All steady state requirements per Section D5 and D6 shall be met. During this FA test, the following items shall be recorded along with all other data requirements:

D7.6.2.1 At least one of fan motor current (A), fan motor speed (rpm) or fan motor power (W).

D7.6.2.2 When applicable, refrigerant pressures at the high side and low side unit service connections closest to compressor.

D7.6.2.3 When pressures cannot be measured on round tube plate fin coils, the temperature at the midpoint of the uppermost refrigerant circuit, and the temperature at the midpoint of the lowermost refrigerant circuit of the Outdoor Coil.

D7.6.3 Outdoor duct losses shall be calculated for all closed duct tests per ANSI/ASHRAE Standard 37 Section 7.3.3.3 for cooling mode and ANSI/ASHRAE Standard 37 Section 7.3.4.3 for heating mode. Net capacities shall be adjusted accordingly.

D7.6.4 Immediately following the FA test conducted per Section D7.6.2, the ductwork meeting requirements of Section D7.5 shall be added to the Outdoor Unit, and a Closed Duct (CD) test shall be conducted. All steady state requirements per Section 5 and 6 shall be met. During this CD test the following requirements shall be met:

D7.6.4.1 The average inlet indoor DB temperature shall be within 0.25 °F of the FA test.

D7.6.4.2 The average inlet indoor WB temperature shall be within 0.15 °F of the FA test, except for split-system heating mode tests.

D7.6.4.3 The average inlet outdoor DB temperature shall be within 0.25 °F of the FA test.

D7.6.4.4 The average inlet outdoor WB temperature shall be within 0.15 °F of the FA test., except for split-system cooling mode tests.

D7.6.4.5 Fan motor current, if measured, shall be within 3.0% of the value measured in Section D7.6.2.1.

D7.6.4.6 Fan motor speed, if measured, shall be within 5 rpm of the value measured in D7.6.2.1.

D7.6.4.7 Fan motor power, if measured, shall be within 3.0% of the value measured in D7.6.2.1.

D7.6.4.8 Refrigerant high side pressures of the CD test measured per Section D7.6.1.3 shall be within 0.5°F saturation temperatures of the FA test for all refrigerants (2 psig for systems using refrigerants R-410A or R-22).

D7.6.4.9 Refrigerant low side pressures of the CD test measured per Section D7.6.1.3 shall be within 0.3 °F saturation temperatures of the FA test for all refrigerants (0.5 psig for systems using refrigerants R-410A or R-22).

D7.6.4.10 Pressure variation for both high side and low side shall be in the same direction. If

high side pressure is higher in close duct test, low side pressures are not permitted to be lower than CD test (when rounded to closest 0.1 psig).

D7.6.4.11 Refrigerant tube temperatures measured per Section D7.6.2.3 shall be within 0.5°F of the FA test.

D7.6.4.12 Measured q_{tia} shall be within 2.0% of the FA test.

D7.6.4.13 Absolute value of HB shall be 6.0% or less.

D7.6.4.14 Outdoor duct static pressure during this CD test shall be recorded with all other parameters, including average, minimum and maximum.

D7.6.5 All other tests in each operational mode may be made with the outdoor duct remaining connected to the Outdoor Unit as long as the same average outdoor duct static pressure recorded per Section D7.6.4.14 is maintained, within 0.01 in H₂O. Additionally, the total observed range (maximum value minus the minimum value) for each additional test may be no greater than the total observed range of the previous CD test.

APPENDIX E. ANSI/ASHRAE STANDARD 37 CLARIFICATIONS/EXCEPTIONS – NORMATIVE

The following sections are clarifications and exceptions to ANSI/ASHRAE Standard 37.

E1 Section 5.1 of ANSI/ASHRAE 37 shall have the following clarifications made for temperature measuring instruments:

Add the following section: “*Water vapor content measurement.* As specified in ANSI/ASHRAE 41.1, the temperature sensor (wick removed) shall be accurate to within 0.2 °F. If used, apply dew point hygrometers as specified in Sections 5 and 8 of ANSI/ASHRAE Standard 41.6. The dew point hygrometers shall be accurate to within 0.4 °F when operated at conditions that result in the evaluation of dew points above 35 °F, or if used, a relative humidity (RH) meter shall be accurate to within 0.7% RH (both at the (80/67 °F test conditions). Other means to determine the psychrometric state of air may be used as long as the measurement accuracy is equivalent to or better than the accuracy achieved from using a wet-bulb temperature sensor that meets the above specifications.”

E2 Add the following as Section 5.4.5 to ANSI/ASHRAE Standard 37: “When testing air conditioners and heat pumps having a Variable Speed Compressor, an induction watt/watt hour meter shall not be used.”

E3 Section 6.1.2 of ANSI/ASHRAE Standard 37 shall be modified by replacing the last sentence with the following, “Maintain the dry bulb temperature within the test room within 5.0 °F of the required dry bulb temperature test condition for the air entering the Indoor Unit. Dew point shall be within 2 °F of the required inlet conditions.”

E4 Section 6.2.7 of ANSI/ASHRAE Standard 37 shall have the following references added for static pressure tap positioning:

E4.1 Add the following section: “*Airflow Measuring Apparatus.* Refer to Figure 12 of ANSI/ASHRAE Standard 51/AMCA Standard 210 or Figure 14 of ANSI/ASHRAE Standard 41.2 (RA 92) for guidance on placing the static pressure taps and positioning the diffusion baffle (settling means) relative to the chamber inlet.”

E5 Section 6.4.2.2 of ANSI/ASHRAE Standard 37 shall have the following corrections and clarifications for the inlet plenum:

E5.1 Add the following sentences: “For Blower Coil Systems and Single Package Units, an inlet plenum, equaling the size of the inlet opening meeting the requirements of Figures 7b and 7c shall be installed, unless an Airflow Prevention Device is installed, in which case the inlet plenum is optional. For Coil-Only Systems, an inlet plenum shall be installed per Figure 8. Four static pressure taps shall be located in the center of each face. This inlet plenum shall be connected directly to the inlet of the unit.”

E6 Section 6.4.3 of ANSI/ASHRAE Standard 37 shall have the following corrections and clarifications made for Small-duct, High-velocity Systems added:

E6.1 Add the following sentences: “For Small-duct, High-velocity Systems, install an outlet plenum that has a diameter that is equal to or less than the value listed below. The limit depends only on the Cooling Full-Load Air Volume Rate and is effective regardless of the flange dimensions on the outlet of the unit (or an air supply plenum adapter accessory, if installed in accordance with the Installation Instructions).”

Cooling Full-load Air Volume Rate, scfm	Maximum Diameter ¹ of Outlet Plenum, in
≤ 500	6
501 to 700	7
701 to 900	8
901 to 1100	9
1101 to 1400	10
1401 to 1750	11
Note 1. If the outlet plenum is rectangular, calculate its equivalent diameter using $(4A)/P$, where A is the area and P is the perimeter of the rectangular plenum, and compare it to the listed maximum diameter.	

E7 Section 6.5 of ANSI/ASHRAE Standard 37 shall have the following information added regarding static pressure measurement:

E7.1 Add the following sections: “*Indoor coil static pressure difference measurement.* Connect one side of the differential pressure instrument to the manifolded pressure taps installed in the outlet plenum. Connect the other side of the instrument to the manifolded pressure taps located in the inlet plenum. For Non-ducted systems that are tested with multiple outlet plenums, measure the static pressure within each outlet plenum relative to the surrounding atmosphere.

E7.2 *Test set-up on the outlet side of the indoor coil.*

~~a-~~**E7.2.1** Install an interconnecting duct between the indoor coil outlet plenum and the airflow measuring apparatus. The cross-sectional flow area of the interconnecting duct shall be equal to or greater than the flow area of the outlet plenum or the common duct used when testing Non-ducted Systems having multiple indoor coils. If needed, use adaptor plates or transition duct sections to allow the connections. To minimize leakage, tape joints within the interconnecting duct (and the outlet plenum). Construct or insulate the entire flow section with thermal insulation having a nominal overall resistance (R-value) of at least ~~25~~**19** hr·ft²·°F/Btu.

~~b-~~**E7.2.2** Install a grid(s) of dry-bulb temperature sensors inside the interconnecting duct. Also, install an air sampling device, or the sensor(s) used to measure the water vapor content of the outlet air, inside the interconnecting duct. Locate the dry-bulb temperature grid(s) upstream of the air sampling device (or the in-duct sensor(s) used to measure the water vapor content of the outlet air). Air that circulates through an air sampling device and past a remote water-vapor-content sensor(s) shall be returned to the interconnecting duct at a point which needs the following requirements:

E7.2.2.1 Downstream of the air sampling device;

E7.2.2.2 Upstream of the outlet air damper box, if installed;

E7.2.2.3 Upstream of the airflow measuring apparatus.

E7.2.43 *Minimizing Air Leakage.* For Small-duct, High-velocity Systems, install an air damper near the end of the interconnecting duct, just prior to the transition to the airflow measuring apparatus. To minimize air leakage, adjust this damper such that the pressure in the receiving chamber of the airflow measuring apparatus is no more than 0.5 in of water higher than the surrounding test room ambient. In lieu of installing a separate damper, use the outlet air damper box if it allows variable positioning. Also apply these steps to any conventional indoor blower unit that creates a static pressure within the receiving chamber of the airflow measuring apparatus that exceeds the test room ambient pressure by more than 0.5 in of water column.”

E8 Section 6.6.1 of ANSI/ASHRAE Standard 37 shall have the following corrections and clarifications made for duct insulation requirements:

E8.1 Add the following section: “*Indoor coil inlet and outlet duct connections.* Insulate and/or construct the outlet plenum and the inlet plenum with thermal insulation having a nominal overall resistance (R-value) of at least ~~25~~**19** hr·ft²·°F/Btu”.

E8.2 Add the following sentences: “Add a static pressure tap to each face of each outlet plenum, if rectangular, or at four evenly distributed locations along the circumference of an oval or round plenum. Create a manifold that connects the four static pressure taps. Figure E1 of AHRI Standard 210/240 shows the options allowed for the manifold configuration. See Figures 7a, 7b, 7c, and 8 (of ANSI/ASHRAE Standard 37) for the cross-sectional dimensions and minimum length of each plenum and the locations for adding the static pressure taps for units tested with and without an indoor fan installed.”

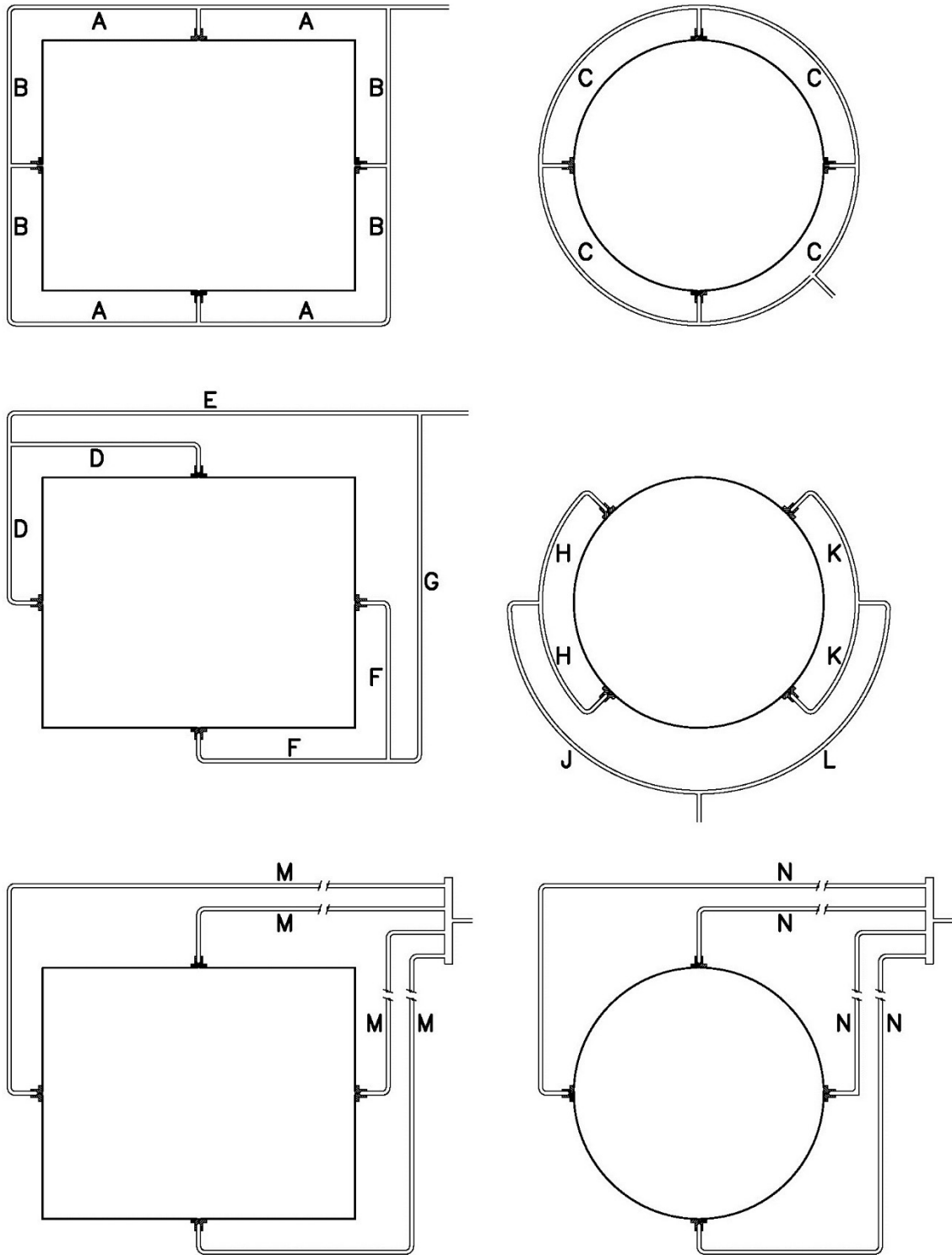

Figure E1. Configurations for Manifolding the Static Pressure Taps

E9 Append the following sentence to the end of Section 7.5.2.1 of ANSI/ASHRAE Standard 37: “Refrigerant flow measurement device(s) shall be either elevated at least two feet from the test chamber floor or placed upon insulating material having a total thermal resistance (R-value) of at least $12 \text{ hr} \cdot \text{ft}^2 \cdot \text{°F}/\text{Btu}$, and extending at least one foot laterally beyond each side of the device(s)’ exposed surfaces.”

E10 Sections 8 of ANSI/ASHRAE Standard 37 shall be modified by inserting a new Section 8.9 as follows,

E10.1 *Test Operating Procedures for Variable Speed Products.*

E.10.1.1 *Special Requirements for Multi-split Air-conditioners and Heat Pumps, and Systems Composed of Multiple Mini-Split Units (Outdoor Units Located Side-by-Side) that would normally operate using two or more Indoor Thermostats.* For any test where the system is operated at part load (i.e., one or more compressors OFF, operating at the intermediate or minimum compressor speed, or at low compressor capacity), the manufacturer shall specify the parameters for indoor coil operation during the part load test. For Variable Speed Systems, the manufacturer shall designate the operating blower speeds for all Indoor Units for all tests conducted at minimum compressor speed. For all other part load tests, the manufacturer shall choose to turn off one, two, or more Indoor Units. The chosen configuration shall remain unchanged for all tests conducted at the same compressor speed/capacity. For any indoor coil that is turned off during a test, take steps to cease forced airflow through this indoor coil and block its outlet duct. Because these types of systems will have more than one indoor fan and possibly multiple outdoor fans and compressor systems, references in this test procedure to a single indoor fan, outdoor fan, and compressor means all indoor fans, all outdoor fans, and all compressor systems that are turned on during the test.”

E11 Section 8.2 of ANSI/ASHRAE Standard 37 shall have the following changes:

E11.1 Add General Requirements. “*General Requirements.* If, during the testing process, an equipment set-up adjustment is made that would alter the performance of the unit when conducting an already completed test, then repeat all tests affected by the adjustment.”

E11.2 Section 8.2.2 of ANSI/ASHRAE Standard 37 shall have the following corrections and clarifications made for indoor coils supplied without an enclosure:

E11.2.1 Modify the sentence to read: “No alterations to the equipment shall be made except for the attachment of required test apparatus and instruments in the prescribed manner and disabling heat pump resistance elements used for heating indoor air at all times, including during defrost cycles.”

E11.2.2 Add the following sentence: “For Uncased Coils enclosure, create an enclosure using 1 in thick fiberglass ductboard. Or alternatively, use some other insulating material having a thermal resistance (“R” value) between 4 and 6 h·ft²·°F/Btu. For Cased Coils, no extra insulating or sealing is allowed.”

E11.3 Section 8.2.3 of ANSI/ASHRAE Standard 37-2009 shall have the following corrections and clarifications made for refrigerant charging:

E11.3.1 Add the following section: “*Additional Refrigerant Charging Requirements.* For Split Systems, unless specifically stated for an outdoor to indoor match, adjust the charge to the outdoor unit instructions. When multiple methods are provided, the manufacturer shall specify the recommended method. If a method is not recommended by the manufacturer, for systems that use a TXV, charge the system to sub-cooling, for systems that use a fixed orifice charge to super heat.”

E11.4 Section 8.2.4 of ANSI/ASHRAE Standard 37 shall have the following requirements and modifications added regarding interconnecting tubing.

E11.4.1 *Requirements for Separated Assemblies.* Such equipment in which the interconnection tubing is furnished as an integral part of the machine not recommended for cutting to length shall be tested with the complete length of tubing furnished. An exception is made for Split Systems units that are meant to be installed indoors. The line sizes, insulation, and details of installation shall be in accordance with the manufacturer’s published recommendation.

E11.4.2 For those systems where the outdoor section is located in the exterior ambient space, at least 40% of the total line set of the interconnecting tubing shall be exposed to the outside conditions. The line sizes, insulation, and details of insulation shall be in accordance with the manufacturer’s published recommendations.

E11.4.3 For those systems where the outdoor section is not located in the exterior ambient space, all of the interconnecting tubing shall be exposed to the inside conditions. The line sizes, insulation, and details of insulation shall be in accordance with the manufacturer’s published recommendations.

E11.4.4 Modify by appending “At a minimum, insulate the interconnecting vapor line(s) of a split-system with insulation having an inside diameter that matches the refrigerant tubing and an R value between 4 to 6 hr·ft²·°F/Btu.”

E11.5 Replace Section 8.2.5 of ANSI/ASHRAE Standard 37 with the following: “If pressure measurement devices are connected to a cooling/heating heat pump refrigerant circuit, the refrigerant charge M_t that could potentially transfer out of the connected pressure measurement systems (transducers, gauges, connections, and lines) between operating modes shall be less than 2% of the factory refrigerant charge listed on the nameplate of the Outdoor Unit. If the outdoor unit nameplate has no listed refrigerant charge, or the heat pump is shipped without a refrigerant charge, use a factory refrigerant charge equal to 30 ounces per ton of certified cooling capacity. Use Equation E1 to calculate M_t for heat pumps that have a single expansion device located in the Outdoor Unit to serve each Indoor Unit, and use Equation E2 to calculate M_t for heat pumps that have two expansion devices per Indoor Unit.”

$$M_t = \rho (V_5 \cdot f_5 + V_6 \cdot f_6 + V_3 + V_4 - V_2) \tag{E1}$$

$$M_t = \rho (V_5 \cdot f_5 + V_6 \cdot f_6) \tag{E2}$$

Where

V_i = Internal volume of pressure measurement system (pressure lines, fittings, gauges and/or transducers) at location i , in³

f_i = Tubing routing factor, 0 if the pressure measurement system is pitched upwards from the pressure tap location to the gauge or transducer, 1 if it is not.

Table E1. Pressure Measurement Location	
Location	Number
Compressor Discharge	1
Between Outdoor Coil and Outdoor Expansion Valve	2
Liquid Service Valve	3
Indoor Coil Inlet	4
Indoor Coil Outlet	5
Common Suction Port (i.e. vapor Service Valve)	6
Compressor Suction	7

Calculate the internal volume of each pressure measurement system using internal volume reported for pressure transducers and gauges in product literature, if available. If such information is not available, use the value of 0.1 in³ internal volume for each pressure transducer, and 0.2 in³ for each pressure gauge. In addition, for heat pumps that have a single expansion device located in the Outdoor Unit to serve each Indoor Unit, the internal volume of the pressure system at location 2 (as indicated in Table E1 of AHRI Standard 210/240) shall be no more than 1 in³. Once the pressure measurement lines are set up, no change shall be made until all tests are finished.

E11.6 Insert a new Section 8.2.8 into Section 8.2 of ANSI/ASHRAE Standard 37: “8.2.8. If the Outdoor Unit or the outdoor portion of a Single Package Unit has a drain pan heater to prevent freezing of defrost water, the heater shall be energized, subject to control to de-energize it when not needed by the heater’s thermostat or the unit’s control system, for all tests.”

E12 *Test Unit Installation Requirements.* Append the following to Section 8.5.3 of ANSI/ASHRAE Standard 37. “In the case of Non-ducted Systems having multiple indoor coils, locate a grid approximately 6 in upstream from the inlet of each indoor coil. Position an air sampling device, or the sensor used to measure the water vapor content of the inlet air, immediately upstream of the (each) entering air dry-bulb temperature sensor grid. If a grid of sensors is not used, position the entering air sampling device (or the sensor used to measure the water vapor content of the inlet air) as if the grid were present.”

E13 Add the following (Sections E13.1 to E13.6 of this Standard) to make a new Section 8.5.6, with subsections, of ANSI/ASHRAE Standard 37 entitled: “*Air Sampling Requirements.*”

E13.1 Purpose. The purpose of this section is to prescribe a method for the sampling of air to measure the dry bulb and wet bulb temperatures for indoor inlet and outlet as well as outdoor inlet measurements. This section also defines the requirements for controlling the air stratification and what is considered acceptable for a test. Measurement of the air temperatures are needed to establish that the conditions are within the allowable tolerances of this Standard as well as used for the calculation of the psychrometric capacity.

E13.2 Definitions.

E13.2.1 Air Sampling Device. A combination of Air Sampling Tree(s), conduit, fan and Aspirating Psychrometer or Dew-point Hygrometer used to determine dry-bulb temperature and moisture content of an air sample from critical locations.

E13.2.1.1 Air Sampling Tree. The Air Sampling Tree is an assembly consisting of a manifold with several branch tubes with multiple sampling holes that draws an air sample from a critical location from the unit under test (e.g. indoor air inlet, indoor air outlet, outdoor air inlet, etc.). See Section E4.4 for design requirements.

E13.2.1.2 Aspirating Psychrometer. A piece of equipment with a monitored airflow section that draws uniform airflow through the measurement section and has probes for measurement of air temperature and humidity. See Section E4.5 for design requirements.

E13.2.1.3 Dew-point Hygrometer. An instrument used to determine the humidity of air by detecting visible condensation of moisture on a cooled surface.

E13.3 General Requirements. Temperature measurements shall be made in accordance with ANSI/ASHRAE Standard 41.1. Where there are differences between this document and ANSI/ASHRAE Standard 41.1, this document shall prevail.

To ensure adequate air distribution, thorough mixing, and uniform air temperature, it is important that the room and test setup is properly designed and operated. To check for uniformity of outdoor inlet air, a grid of individual thermocouples on the sampler tree(s) shall be installed, and a maximum of 2.0°F between individual thermocouple and the average grid inlet air temperature shall be maintained. Air distribution at the test facility point of supply to the unit shall be reviewed and may require remediation prior to the beginning of testing. Mixing fans can be used to ensure adequate air distribution in the test room. If used, mixing fans shall be oriented such that they are pointed away from the air intake so that the mixing fan exhaust cannot be directed at or away from the air entrance to the condenser air inlet. Particular attention should be given to prevent recirculation of condenser fan exhaust air back through the unit.

E13.4 Air Sampling Tree Requirements. The Air Sampling Tree is intended to draw a sample of the air at the critical locations of a unit under test. A typical configuration for the Air Sampling Tree is shown in Figure E2 of AHRI Standard 210/240. It shall be constructed of stainless steel, plastic or other suitable, durable materials. It shall have a main flow trunk tube with a series of branch tubes connected to the trunk tube. Holes shall be on the side of the sampler facing the upstream direction of the air source. Other sizes and rectangular shapes can be used, and shall be scaled accordingly with the following guidelines:

- E13.4.1** Minimum hole density of 6 holes per square foot of area to be sampled
- E13.4.2** Sampler branch tube pitch (spacing) of 6 ± 3 in
- E13.4.3** Manifold trunk to branch diameter ratio having a minimum of 3:1 ratio
- E13.4.4** Hole pitch (spacing) shall be equally distributed over the branch (1/2 pitch from the closed end to the nearest hole)
- E13.4.5** Maximum individual hole to branch diameter ratio of 1:2 (1:3 preferred)

The minimum average velocity through the Air Sampling Tree holes shall be 2.5 ft/s as determined by evaluating the sum of the open area of the holes as compared to the flow area in the Aspirating Psychrometer. Preferentially, the Air Sampling Tree should be hard connected to the Aspirating Psychrometer, but if space constraints do not allow this, the assembly shall have a means of allowing a flexible tube to connect the Air Sampling Tree to the Aspirating Psychrometer.

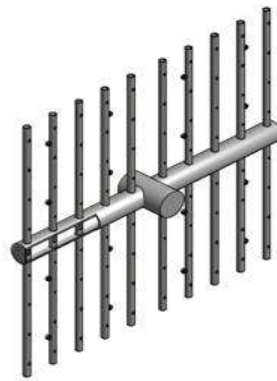

Figure E2. Typical Air Sampling Tree

The Air Sampling Tree shall also be equipped with a thermocouple thermopile, thermocouple grid or individual thermocouples to measure the average temperature of the airflow over the Air Sampling Tree. Per ANSI/ASHRAE Standard 116, the thermocouple arrangement per Air Sampling Tree shall have at least 16 measuring points, spaced evenly across the Air Sampling Tree. In the outdoor inlet location, the Air Sampling Trees shall be placed within 6-24 in of the unit to minimize the risk of damage to the unit while ensuring that the air sampling tubes are measuring the air going into the unit rather than the room air around the unit and care shall be taken to assure that the upper sampling holes are not pulling in the discharge air leaving the outdoor section of the unit under test. Any sampler holes outside of the plane perpendicular to the condenser fan discharge shall be blocked to prevent the sampling of recirculated air. Blocking holes does not necessarily prohibit thermal transfer on samplers therefore the portion beyond the plane shall be thermally shielded with a material with an R value between 4 to 6 $\text{h} \cdot \text{ft}^2 \cdot ^\circ\text{F}/\text{Btu}$.

E13.5 Psychrometer. The psychrometer consists of a flow section and a fan to draw air through the flow section and measures an average value of the sampled air stream. At a minimum, the flow section shall have a means for measuring the dry bulb temperature (typically, a resistance temperature device (RTD) and a means for measuring the humidity (RTD with wetted sock, chilled mirror hygrometer, or relative humidity sensor). In most typical applications, there are typically two sets of measurements for temperature and humidity, one for the rough room control, and the other for the fine control and actual measurement. The Aspirating Psychrometer shall include a fan that either can be adjusted manually or automatically to maintain required velocity across the sensors. A typical configuration for the Aspirating Psychrometer is shown in Figure E3 of AHRI Standard 210/240.

The psychrometer shall be made from suitable material which may be plastic (such as polycarbonate), aluminum or other metallic materials. Outside diameters are typically 4 in but may be as small as 2 in or as large as 6 in. All psychrometers for a given system being tested, shall be constructed of the same material. Psychrometers shall be designed such that radiant heat from the motor does not affect sensor measurements. For Aspirating Psychrometers, velocity across the wet bulb sensor shall be 1000 ± 200 ft/min. For all other psychrometers, velocity shall be as specified by the sensor manufacturer.

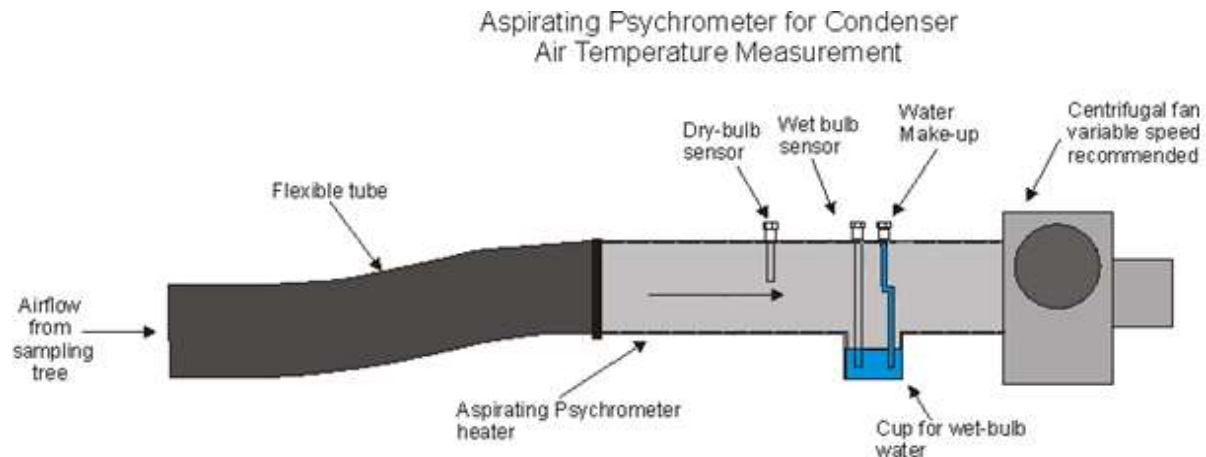

Figure E3. Aspirating Psychrometer

E13.6 *Test Setup Description.* For the outdoor air inlet location, wet-bulb and/or dry-bulb temperature shall be measured at multiple locations entering the outdoor section, based on the airflow nominal face area at the point of measurement. Multiple temperature measurements shall be used to determine acceptable air distribution and the mean air temperature.

The Air Sampling Trees in the outdoor air inlet location shall be sized such that they cover at least 75% of the face area of the side of the coil that they are measuring. The Air Sampler Tree may be larger than the face area of the side being measured, however care shall be taken to prevent discharge air from being sampled (if an Air Sampler Tree dimension extends beyond the inlet area of the unit, holes shall be blocked in the Air Sampler Tree to prevent sampling of discharge air). Each outdoor coil side shall have one Air Sampler Tree.

The Air Sampler Trees shall be located at the geometric center of each side; either horizontal or vertical orientation of the branches is acceptable. A maximum of four Air Sampling Trees shall be connected to each Aspirating Psychrometer. The Air Sampling Trees shall be connected to the Aspirating Psychrometer using tubing that is insulated with thermal insulation with a nominal thermal resistance (R-value) of at least $19 \text{ h}\cdot\text{ft}^2\cdot\text{F}/\text{Btu}$ and routed to prevent heat transfer to the air stream. In order to proportionately divide the flow stream for multiple Air Sampling Trees for a given Aspirating Psychrometer, the tubing shall be of equivalent lengths for each Air Sampling Tree. Alternative to insulating the tubing between the Air Sampling Tree and the Aspirating Psychrometer, a dry-bulb measuring device may be located at both the immediate exit of the Air Sampling Tree and internal to the Aspirating Psychrometer, with both measurements utilized to determine the water vapor content of sampled air.

E14 Add the following to make a new Section 8.5.7 of ANSI/ASHRAE Standard 37:

E14.1 “The Air Sampling Tree and Psychrometer shall be used to measure inlet air properties for all tests and to measure outlet air properties for all Steady State Tests. The Air Sampling Tree and Psychrometer shall not be used to measure the indoor outlet air properties for tests other than Steady State Tests, which shall have outlet air properties measured with a thermopile or thermocouple grid.” [thermopile or thermocouple grid as defined in Section E7.2 of this Standard].

E14.2 “In lieu of an Air Sampling Tree and Psychrometer on every air-inlet side of an Outdoor Unit, it is permissible to use an Air Sampling Tree on one or more faces of the Outdoor Unit and demonstrate air temperature uniformity as follows. Install a grid of evenly-distributed thermocouples on each air-permitting face on the inlet of the Outdoor Unit. Install the thermocouples on the air sampling device, locate them individually or attach them to a wire structure. If not installed on the air sampling device, install the thermocouple grid 6 to 24 in from the unit. The thermocouples shall be evenly spaced across the coil inlet surface and be installed to avoid sampling of discharge air or blockage of air recirculation. The grid of thermocouples shall provide at least 16 measuring points per face or one measurement per square foot of inlet face area, whichever is less. This grid shall be constructed and used as per Section 5.3 of ANSI/ASHRAE Standard 41.1. The maximum difference between the readings of any two pairs of these individual thermocouples located at any of the faces of the inlet of the Outdoor Unit, shall not exceed $2.0 \text{ }^\circ\text{F}$.”

E15 Section 8.7 of ANSI/ASHRAE Standard 37 shall have the following changes:

E15.1 Section 8.7 of ANSI/ASHRAE Standard 37 shall have the following corrections and clarifications made for multiple speed outdoor fan motors. Add the following section: “*Special Requirements for Units having a Multiple Speed Outdoor Fan.* The controls of the unit shall regulate the operation of the outdoor fan during all laboratory tests except dry coil cooling mode tests. For dry coil cooling mode tests, the outdoor fan shall operate at the same speed used during the required Wet-coil Test conducted at the same outdoor test conditions.”

E15.2 Section 8.7.1 of ANSI/ASHRAE Standard 37 shall be modified by appending the following sentence, “The test room reconditioning apparatus and equipment under test shall be operated under equilibrium conditions for at least 30 minutes before test data are reported.”

E16 Section 8.8 of ANSI/ASHRAE Standard 37 shall have the following changes:

E16.1 Section 8.8.1 of ANSI/ASHRAE Standard 37 shall have the following corrections and clarifications made for demand defrost systems. Add the following section: “*Defrost Control Settings.* Heat pump defrost controls shall be left at the factory settings unless otherwise specified by the Installation Instructions. For demand defrost systems, if specified by the manufacturer, a control board reset shall be allowed just prior to the defrost test.”

E16.2 Sections 8.8.2.3 and 8.8.3.4 of ANSI/ASHRAE Standard 37 shall be modified by replacing “one hour” with “30-minute.” This requirement is waived when the heating test is at a frosting condition.

E17 Section 10.1 of ANSI/ASHRAE Standard 37 shall have the following changes:

E17.1 Insert Section 10.1.2.1 to ANSI/ASHRAE Standard 37: 10.1.2.1 For this capacity (heat balance) comparison, use the Indoor Air Enthalpy Method capacity that is calculated in Sections 7.3.3 and 7.3.4 of ANSI/ASHRAE Standard 37 (except, if testing a Coil-only System, do not make the after-test fan heat adjustments).

E18 Tables 2a and 2b of ANSI/ASHRAE Standard 37 shall have the following data added:

E18.1 2.0% Electrical voltage test operating tolerance.

E18.2 1.5% Electrical voltage test condition tolerance.

APPENDIX F. ANSI/ASHRAE STANDARD 116- 2010 CLARIFICATIONS/EXCEPTIONS – NORMATIVE

F1 *Definitions.*

F1.1 Add the following definitions to ANSI/ASHRAE Standard 116:

F1.1.1 *Damper Box.* A short section of insulated duct having a means to block airflow during the off cycle of the Cyclic Test.

F1.1.2 *Defrost Cycle.* The period from Defrost Initiation to Defrost Termination.

F1.1.3 *Defrost Initiation.* The moment the controls of the heat pump first alter its normal heating operation in order to eliminate possible accumulations of frost on the Outdoor Coil.

F1.1.4 *Defrost Termination.* The moment the controls of the heat pump actuate the first change in converting from defrost operation to normal heating operation.

F1.1.5 *Dry-Coil Test.* Cooling mode test where the wet-bulb temperature of the air supplied to the indoor coil is maintained low enough that no condensate forms on this coil.

F1.2 Modify the following definitions in ANSI/ASHRAE Standard 116 as described:

F1.2.1 *Cooling Load Factor (CLF).* The ratio having as its numerator the total cooling delivered during a cyclic operating interval consisting of one ON period and one OFF period. The denominator is the total cooling that would be delivered, given the same ambient conditions, if the unit operated continuously at its steady-state space cooling capacity for the same total time (ON plus OFF) interval (derived by the equation in 9.2.2).

F1.2.2. *Heating Load Factor (HLF).* The ratio having as its numerator the total heating delivered during a cyclic operating interval consisting of one ON period and one OFF period. The denominator is the total heating that would be delivered, given the same ambient conditions, if the unit operated continuously at its steady-state space heating capacity for the same total time (ON plus OFF) interval (derived by the equation in 9.2.4).

F2 Section 5.1.4 of ANSI/ASHRAE Standard 116 shall be modified as follows: “It is required that the same instrumentation be used for making both steady-state and non-steady (cyclic) test measurements”.

F3 Section 5.4 of ANSI/ASHRAE Standard 116 shall have the following clarifications made for the electrical instruments section:

F3.1 Section 5.4.1 of ANSI/ASHRAE Standard 116 shall be clarified by adding the following: “When performing Cyclic Tests on Non-ducted Systems, provide instrumentation to determine the average electrical power consumption of the indoor fan motor to within $\pm 1.0\%$. This same instrumentation requirement applies when testing air-conditioners and heat pumps having a Constant-torque AMS or a Constant-volume AMS.”

F3.2 Section 5.4.2 of ANSI/ASHRAE Standard 116 shall be clarified with the following: “Use an integrating power (watt-hour) measuring system to determine the electrical energy or average electrical power supplied to all components of the air-conditioner or heat pump (including auxiliary components such as controls, transformers, Crankcase Heater, integral condensate pump on Non-ducted Indoor Units, etc.). Activate the scale or meter having the lower power rating within 15 seconds after beginning an OFF cycle. Activate the scale or meter having the higher power rating active within 15 seconds prior to beginning an ON cycle. When testing air-conditioners and heat pumps having a Variable Speed Compressor, do not use an induction watt/watt-hour meter.”

F3.3 Append the following sentence to Section 5.4.2 of ANSI/ASHRAE Standard 116: “When performing test that are not Steady State Tests on Non-ducted Systems, provide instrumentation to determine the average electrical power consumption of the indoor blower motor to within $\pm 1.0\%$.”

- F4** The second and third sentences of Section 6.1.1 of ANSI/ASHRAE Standard 116 shall be modified to say: “The dampers shall be capable of being completely opened or completely closed within a time period not to exceed 5 seconds for each action. Airflow through the equipment being tested should stop within 5 seconds after the airflow measuring device is de-energized.”
- F5** Add the following sentences to Section 6.1.1 of ANSI/ASHRAE Standard 116:
- F5.1** “The arrangement and size(s) of the components may be altered to meet the physical requirements of the unit to be tested.”
- F5.2** “Use an inlet and outlet air Damper Box or Airflow Prevention Device when testing Ducted Systems if conducting one or both of the Cyclic Tests. Otherwise, install an outlet air Damper Box or Airflow Prevention Device when testing heat pumps, both ducted and non-ducted, that cycle off the indoor fan during Defrost Cycles if no other means is available for preventing natural or forced convection through the Indoor Unit when the indoor fan is off.”
- F5.3** “Inlet dampers shall not be used on Non-ducted systems.”
- F5.4** “Dampers shall have a cross-sectional flow area of the Damper Box that shall be equal to or greater than the flow area of the inlet plenum.”
- F5.5** “Install the Damper Box immediately upstream of the inlet plenum. The cross-sectional dimensions of the Damper Box shall be equal to or greater than the dimensions of the indoor unit inlet. If needed, use an adaptor plate or a short transition duct section to connect the Damper Box with the unit's inlet plenum.”
- F5.6** “If using an outlet air Damper Box, install it within the interconnecting duct at a location upstream of the location where air from the sampling device is reintroduced or upstream of the in-duct sensor that measures water vapor content of the outlet air. The leakage rate from the combination of the outlet plenum, the closed damper, and the duct section that connects these two components shall not exceed 20 cfm when a negative pressure of 1.0 in H₂O is maintained at the outlet of the outlet air damper.”
- F5.7** Add the following new paragraph to Section 6.1.1 of ANSI/ASHRAE Standard 116: “Airflow Prevention Device Requirements: Construct the Airflow Prevention Device having a cross-sectional flow area equal to or greater than the flow area of the inlet plenum. Install the Airflow Prevention Device immediately upstream of the inlet plenum (if installed, otherwise immediately upstream of the Indoor Unit) and construct ductwork connecting it to the inlet plenum. If needed, use an adaptor plate or a transition duct section to connect the Airflow Prevention Device with the inlet plenum. If an inlet plenum is not used, add static pressure taps at the center of each face of a rectangular Airflow Prevention Device. Insulate the ductwork and inlet plenum with thermal insulation that has a nominal overall resistance (R-value) of at least $19 \text{ h} \cdot \text{ft}^2 \cdot \text{°F/Btu}$.”
- F6** Inlet dampers specified in Section 6.1.1 of ANSI/ASHRAE Standard 116 shall not be used on non-ducted products
- F7** The third and fourth sentences of Section 6.1.2 of ANSI/ASHRAE Standard 116 shall be replaced with the following: “For at least one cooling mode test and one heating mode test per calibration period not to exceed 1 year (or anytime a change is made to the measuring system), monitor the temperature distribution of the air leaving the indoor coil using the grid of individual sensors. For this 30-minute data collection interval used to determine capacity, the maximum difference among the outlet dry bulb temperatures from any data sampling shall not exceed 1.5 °F.”
- F8** Add the following new Section 6.1.6 to Section 6.1 of ANSI/ASHRAE Standard 116 “6.1.6 Test set up, temperature and electrical measurements methods shall be identical for both the dry steady state and their corresponding Cyclic Tests (e.g. "C" and "D" tests) in order to minimize errors in the cyclic Degradation Coefficient, C_D .”
- F9** Section 6.3 of ANSI/ASHRAE Standard 116 shall be replaced entirely with the following: “Inside the indoor and outdoor psychrometric rooms, use artificial loads during Cyclic Tests and frost accumulation tests, if needed, to produce stabilized room air temperatures. For the outdoor psychrometric room, select an electric resistance heater(s) having a heating capacity that is approximately equal to the heating capacity of the test unit's condenser. For the indoor psychrometric room, select a heater(s) having a capacity that is close to the Sensible Cooling Capacity of the test unit's evaporator. When applied, cycle the heater located in the same room as the test unit evaporator coil ON and OFF when the test unit cycles ON and OFF. Cycle the heater located in the same room as the test unit condensing coil ON and OFF when the test unit cycles OFF and ON.”
- F10** *Thermal Mass Correction.* Replace Section 7.4.3.4.5 (a) of ANSI/ASHRAE Standard 116 with the following: “Thermal

mass shall be calculated using the method specified in Section C5.2 of AHRI Standard 210/240 Appendix C.”

F11 *Test procedures for Frost Accumulation heating mode tests ($H2_{Full}$, $H2_{Int}$, and $H2_{Low}$).* Replace Section 8.2.2 of ANSI/ASHRAE Standard 116 and its subsections in their entirety with the following:

F11.1 For heat pumps containing defrost controls which cause Defrost Initiation at intervals less than one hour, the preliminary test period starts at the termination of an automatic Defrost Cycle and ends at the termination of the next occurring automatic Defrost Cycle. For heat pumps containing defrost controls which cause Defrost Initiation at intervals exceeding one hour, the preliminary test period shall consist of a heating interval lasting at least one hour followed by a Defrost Cycle that is either manually or automatically initiated. In all cases, the heat pump's own controls shall govern when a Defrost Cycle terminates.

F11.2 The official test period begins when the preliminary test period ends, at Defrost Termination. The official test period ends at the next automatically occurring Defrost Termination.

F11.2.1 When testing a heat pump that uses a Time Adaptive Defrost Control System, however, manually initiate the Defrost Cycle that ends the official test period at the instant indicated by instructions provided by the manufacturer. If the heat pump has not undergone a defrost after 6 hours, immediately conclude the test and use the results from the full 6-hour period to calculate the average space heating capacity and average electrical power consumption.

F11.2.2 For heat pumps that turn the indoor fan off during the Defrost Cycle, airflow shall be stopped through the indoor coil by blocking the outlet and inlet plenum whenever the heat pump's controls cycle off the indoor fan. If it is installed, use the outlet Damper Box described in Section 6.1.1 of ANSI/ASHRAE Standard 116 to affect the blocked outlet duct. If it is installed, use the inlet Damper Box described in Section 6.1.1 of ANSI/ASHRAE Standard 116 to affect the blocked inlet plenum.

F11.2.3 For the purpose of determining defrost operation sequence, the first action of Defrost Termination and Defrost Initiation shall be specified by the manufacturer and be made available to the laboratory.

F11.3 To constitute a valid Frost Accumulation test, the test tolerances specified in ANSI/ASHRAE Standard 116 Table 3C shall be satisfied during both the preliminary and official test periods. As noted in ANSI/ASHRAE Standard 116 Table 3C, Test Operating Tolerances are specified for two sub-intervals: (1) When heating, except for the first 10 minutes after the termination of a Defrost Cycle (Sub-interval H, as described in ANSI/ASHRAE Standard 116 Table 3C) and (2) when defrosting, plus these same first 10 minutes after Defrost Termination (Sub-interval D, as described in ANSI/ASHRAE Standard 116 Table 3C). Evaluate compliance with ANSI/ASHRAE Standard 116 Table 3C Test Condition Tolerances and the Test Operating Tolerances using the averages from measurements recorded only during Sub-interval H. Continuously record the dry bulb temperature of the air entering the indoor coil, and the dry bulb temperature and water vapor content of the air entering the Outdoor Coil. Sample the remaining parameters listed in ANSI/ASHRAE Standard 116 Table 3C at equal intervals that span 10 minutes or less. Note that the 10 minutes specified here shall replace the 5 minutes specified in ANSI/ASHRAE Standard 116 Table 3C footnote (1).

F11.4 For the official test period, collect and use the following data to calculate average space heating capacity and electrical power. During heating and defrosting intervals when the controls of the heat pump have the indoor fan on, continuously record the dry-bulb temperature of the air entering (as noted above) and leaving the indoor coil. If using a thermopile, continuously record the difference between the leaving and entering dry-bulb temperatures during the interval(s) that airflows through the indoor coil. For heat pumps tested without an indoor fan installed, determine the corresponding cumulative time (in hours) of indoor coil airflow, $\Delta\tau_a$. Sample measurements used in calculating the air volume rate (refer to Sections 7.7.2.1 and 7.7.2.2 of ANSI/ASHRAE Standard 37) at equal intervals that span 10 seconds or less. Record the electrical energy consumed, expressed in watt-hours, from Defrost Termination to Defrost Termination, $e_{DEF}^k(35)$, as well as the corresponding elapsed time in hours, $\Delta\tau_{FR}$.

F11.5 For heat pumps having a constant-air-volume-rate indoor fan and if the average of the external static pressures measured during sub-Interval H exceeds the minimum (or targeted) external static pressure (ΔP_{min}) by 0.03 in H₂O or more, follow the procedures in AHRI Standard 210/240 Section 6.1.5.1.3.

F12 *Test procedures for the optional cyclic dry-coil cooling-mode tests (D_{Full} , D_{Low} , and I_{Low}).* Add the following sentences immediately following the title of Section 8.2.4 of ANSI/ASHRAE Standard 116: “If optional Cyclic Tests are conducted, they shall follow immediately after the Steady-state Test that requires the same test conditions. When testing heat pumps during the

compressor OFF cycles, leave the reversing valve in the same position as used for the compressor ON cycles, unless automatically changed by the controls of the unit.”

F12.1 Add the following as new Section 8.2.4.3 to ANSI/ASHRAE Standard 116: “For Blower Coil Systems or Coil-only Systems rated with an indoor fan time delay, the ON cycle lasts from compressor ON to indoor fan OFF. For Ducted Systems tested without an indoor fan time delay, the ON cycle lasts from compressor ON to compressor OFF. For Non-ducted Systems, the ON cycle lasts from indoor fan ON to indoor fan OFF.”

F12.2 Add the following as new Section 8.2.4.4 to ANSI/ASHRAE Standard 116: “Inside the psychrometric test rooms (both indoor and outdoor), use artificial loads during Cyclic Tests and frost accumulation tests, if needed, to produce stabilized room air temperatures. For the outdoor room, select an electric resistance heater(s) having a heating capacity that is approximately equal to the heat rejection capacity of the Outdoor Unit. For the indoor room, select a heater(s) having a capacity that is close to the Sensible Cooling Capacity of the Indoor Unit. In the indoor room, cycle the heater ON when the Indoor Unit is ON and cycle the heater OFF when the Indoor Unit is OFF. In the outdoor room, cycle the heater ON when the Outdoor Unit is OFF and cycle the heater OFF when the Outdoor Unit is ON.

F12.3 Add the following as new Section 8.2.4.5 to ANSI/ASHRAE Standard 116: “Inside the psychrometric test rooms (both indoor and outdoor), use artificial loads during Cyclic Tests and frost accumulation tests, if needed, to produce stabilized room air temperatures. For the outdoor room, select an electric resistance heater(s) having a heating capacity that is approximately equal to the heat rejection capacity of the Outdoor Unit. For the indoor room, select a heater(s) having a capacity that is close to the Sensible Cooling Capacity of the Indoor Unit. In the indoor room, cycle the heater ON when the Indoor Unit is ON and cycle the heater OFF when the Indoor Unit is OFF. In the outdoor room, cycle the heater ON when the Outdoor Unit is OFF and cycle the heater OFF when the Outdoor Unit is ON.

F12.4 Add the following as new Section 8.2.4.6 to ANSI/ASHRAE Standard 116: “For units having a Constant-volume AMS or Constant-torque AMS, the manufacturer has the option of electing at the outset whether to conduct the Cyclic Test with the indoor fan enabled or disabled. Conduct the cyclic dry coil test using the draw-through approach described below if any of the following occur when testing with the fan operating:

- F12.4.1** The test unit automatically cycles off;
- F12.4.2** Its blower motor reverses; or
- F12.4.3** The unit operates for more than 30 seconds at an external static pressure that is 0.1 in H₂O or more higher than the value measured during the prior Steady-state Test.

For the draw-through approach, disable the indoor fan and use the exhaust fan of the airflow measuring apparatus to generate the specified flow nozzle static pressure difference or velocity pressure. If the exhaust fan cannot deliver the required pressure difference because of resistance created by the unpowered blower, temporarily remove the blower.”

F12.5 Add the following as new Section 8.2.4.7 to ANSI/ASHRAE Standard 116: “With regard to the Table 3b of ANSI/ASHRAE Standard 116 parameters, continuously record the dry-bulb temperature of the air entering both the Indoor Coil and Outdoor Coils during periods when air flows through the respective coils. Sample the water vapor content of the indoor coil inlet air at least every 2 minutes during periods when air flows through the coil. Record external static pressure and the air volume rate indicator (either nozzle pressure difference or velocity pressure) at least every minute during the interval that air flows through the indoor coil. (These regular measurements of the airflow rate indicator are in addition to the required measurement at 15 seconds after flow initiation.) Sample the electrical voltage at least every 10 seconds beginning 30 seconds after compressor start-up. Continue until the compressor, the outdoor fan, and the indoor fan (if it is installed and operating) cycle off.”

F12.6 Add the following as new Section 8.2.4.8 to ANSI/ASHRAE Standard 116: “For Ducted Systems, continuously record the dry-bulb temperature of the air entering (as noted in Section 8.2.4.7) and leaving the indoor coil. Or if using a thermopile, continuously record the difference between these two temperatures during the interval that air flows through the Indoor Coil. For Non-ducted Systems, make the same dry-bulb temperature measurements beginning when the compressor cycles on and ending when indoor coil airflow ceases.”

F12.7 Add the following as new Section 8.2.4.9 to ANSI/ASHRAE Standard 116: “Integrate each complete cycle as follows:

- F12.7.1** For Blower Coil Systems tested with an indoor fan installed and operating or Coil-only Systems rated with an indoor fan time delay, integrate electrical power from indoor fan OFF to indoor fan OFF.

F12.7.2 For all other Ducted Systems and for Non-ducted Systems, integrate electrical power from compressor OFF to compressor OFF.

F12.7.3 Capacity integration of all systems is from indoor fan ON to indoor fan OFF.”

F12.8 Add the following as new Section 8.2.4.10 to ANSI/ASHRAE Standard 116: “*Ducted system procedures for the optional cyclic dry-coil cooling-mode tests (D_{Full} , D_{Low} , and I_{Low})*. The automatic controls that are normally installed with the test unit shall govern the OFF/ON cycling of the air moving equipment on the indoor side (exhaust fan of the airflow measuring apparatus and, if installed, the indoor fan of the test unit). For Coil-only Systems rated based on using a fan time delay, the indoor coil airflow shall be controlled according to the rated ON and/or OFF delays provided by the fan time delay. For Ducted Systems having a Constant-volume AMS or Constant-torque AMS that has been disabled (and possibly removed), the indoor airflow shall be started and stopped at the same instances as if the fan were enabled. For all other Ducted Systems tested without an indoor fan installed, the indoor coil airflow shall be cycled in unison with the cycling of the compressor. Air dampers shall be closed on the inlet and outlet side (see ANSI/ASHRAE Standard 116 Section 6.1.1) during the OFF period.

Blower Coil Systems with Constant-volume AMS or Constant-torque AMS which has the blower disabled for Cyclic Test, adjust energy based on Equation F1 and capacity per Equation F2

$$Ec_{adj,x} = E_{fan,x} \cdot [\theta_2 - \theta_1] \tag{F1}$$

$$qc_{adj,x} = 3.412 \cdot P_{fan,x} \cdot [\theta_2 - \theta_1] \tag{F2}$$

The following algorithm shall be used to calculate $Ec_{adj,x}$ and $qc_{adj,x}$ in lieu of Equations F1 and F2, at the manufacturer’s discretion, if the indoor fan ramps its speed when cycling.

F12.8.1 Measure the electrical power consumed by the Constant-volume AMS or Constant-torque AMS at a minimum of three operating conditions: at the speed/air volume rate/external static pressure that was measured during the Steady-state Test, at operating conditions associated with the midpoint of the ramp-up interval, and at conditions associated with the midpoint of the ramp-down interval. For these measurements, the tolerances on the airflow volume or the external static pressure are the same as required for the Section 8.2.4.8 Steady-state Test [Section F10.6 of AHRI Standard 210/240].

F12.8.2 For each case, determine the indoor fan power from the average of measurements made over a minimum of 5 minutes.

F12.8.3 Approximate the electrical energy consumption of the indoor fan if it had operated during the Cyclic Test using all three power measurements. Assume a linear profile during the ramp intervals. The manufacturer shall provide the durations of the ramp-up and ramp-down intervals. If a manufacturer-supplied ramp interval exceeds 45 seconds, use a 45-second ramp interval nonetheless when estimating the fan energy.”

F12.9 Add the following as new Section 8.2.4.11 to ANSI/ASHRAE Standard 116: “*Non-ducted System procedures for the optional cyclic dry-coil cooling-mode tests (D_{Full} , D_{Low} , and I_{Low})*.”

Do not use dampers when conducting Cyclic Tests on Non-ducted Systems. Until the last OFF/ON compressor cycle, airflow through the Indoor Coil must cycle off and on in unison with the compressor. For the last OFF/ON compressor cycle—the one used to determine energy and capacity—use the exhaust fan of the airflow measuring apparatus and the indoor fan of the test unit to have indoor airflow start 3 minutes prior to compressor cut-on and end three minutes after compressor cutoff. Subtract the electrical energy used by the indoor fan during the 3 minutes prior to compressor cut-on from the integrated electrical energy. Add the electrical energy used by the indoor fan during the 3 minutes after compressor cutoff to the integrated cooling capacity. For the case where the Non-ducted System uses a variable-speed indoor fan which is disabled during the Cyclic Test, correct $e_{cyc,dry}$ and $q_{cyc,dry}$ using the same approach as prescribed in Section 8.2.4.9 [Section F10.8 of AHRI 210/240] for Blower Coil Systems with Constant-volume AMS or Constant-torque AMS which has the blower disabled for Cyclic Test.”

F13 Heating Cyclic Test Modification. Append the following to Section 9.2.4 of ANSI/ASHRAE Standard 116:

F13.1 “*Test procedures for the optional cyclic heating mode tests ($H0C_{Low}$, $H1C_{Full}$, and $H1C_{Low}$)*. If optional Cyclic Tests are conducted, they shall follow immediately after the Steady-state Test that requires the same test conditions.”

F13.2 “If a heat pump Defrost Cycle is manually or automatically initiated immediately prior to or during the OFF/ON cycling, operate the heat pump continuously until 10 minutes after Defrost Termination. After the 10 minute interval, begin cycling the heat pump immediately or delay until the specified test conditions have been re-established. Prevent defrosts after beginning the cycling process (contact the manufacturer for the procedure on how to prevent defrost). For heat pumps that cycle off the indoor fan during a Defrost Cycle, do not restrict the air movement through the indoor coil while the fan is off. Resume the OFF/ON cycling while conducting a minimum of two complete compressor OFF/ON cycles before determining capacity and energy consumption.”

F14 Make the following corrections to ANSI/ASHRAE Standard 116:

F14.1 Change 43500 to 43400 in Table A-2.

F14.2 Change “Two-Speed” in the title of Table A-5 to “Variable –Speed”.

F14.3 Table A-8 shall be revised as per below. The revised data then provides a match for the example calculations in Table A-3.

	Table A-8 Corrected	
	k=1	k=2
q(62)	42000	*
q(47)	30000	65000
q(35)	22000	50000
q(17)	17000	42000
E(62)	3077	*
E(47)	2930	7054
E(35)	2865	6370
E(17)	2491	5128
Cd	0.2	**

F14.4 The equation for intermediate speed capacity (k=i) on page 25 begins $q_{ss}^{k=i}(t) = q_{ss}^{k=1}(t_{a14}) +$. This should be $q_{ss}^{k=i}(t) = q_{ss}^{k=i}(t_{a12}) +$.

F14.5 On page 25 is the statement "Once the equation for $q_{ss}^{k=1}(t)$ has been determined, the temperature at which $q_{ss}^{k=1}(t) = BL(t)$ can be found. This temperature, designated as t_{vc} , shall be calculated by the following equation:" - the 1's should be i's.

F14.6 The equation for t_{vc} on page 25 begins $33 \cdot q_{ss}^{k=i}(t_{a14})$. Table 8b then lists t_{a14} as a minimum speed point at 67F. t_{a12} is the intermediate speed point, which is the data used in the example calculations of page 41 - the equation for t_{vc} on page 25 should begin $33 \cdot q_{ss}^{k=i}(t_{a12})$.

F14.7 In total, there are 15 references to t_{a14} on page 25 that should be t_{a12} .

F14.8 Based on Equation $Ess^{k=i}(t_{vc}) = Ess^{k=i}(t_{a14}) + Me(t_{vc}-t_{a14})$ on page 25 (bottom left) - the equation on page 39 (bottom right) which reads $Ess^{k=i}(86.88) = 1450 - 8.556 \cdot (86.88 - 87.0)$ should read $Ess^{k=i}(86.88) = 1450 + 8.556 \cdot (86.88 - 87.0)$ then the next line will change from $EER_{ss}^{k=i}(86.88) = 1451.0$ watts to $EER_{ss}^{k=i}(86.88) = 1449.0$ watts.

F14.9 The coefficient at the top of page 40 is calculated as “= - 29.950” the result should be “= -21.950”.

F14.10 The example calculations on page 44 for temperature t_{IV} use F4 in the equation, which agrees with the sentence on page 32 above the equation for t_{IV} that indicates use F3 in the calculation if the calculated value for t_{IV} is greater than t_{a12} (17F) - the sentence on page 32, and on page 44 below the equation for t_{IV} should read “..if LESS than..”.

F14.11 Table A-11 gives the regional outdoor design temperature for region IV as 10 °F - this temperature should be 5 °F, the same as listed in Table 18.

F14.12 ANSI/ASHRAE Standard 116 applies the demand defrost credit to the entire heating load, which includes any auxiliary heat. The credit shall only apply to the heat pump capacity.

APPENDIX G. UNIT CONFIGURATION FOR STANDARD EFFICIENCY DETERMINATION - NORMATIVE

G1 Purpose. The purpose of this appendix is to prescribe the requirements for the configuration of a unit used for determining the Standard Rating cooling and heating capacity and efficiency metrics. This allows for a uniform approach to determine minimum and other standard rating metrics.

G2 Background. The Standard Ratings are intended to be ratings that define the performance of a Basic Model at a defined set of conditions. The ratings are as noted in the AHRI Certification Program Provisions on the inside front cover of this standard.

These products can be complex pieces of equipment that are adapted to operate in a building HVAC system and often applied in non-standard rating conditions and applications. This can include capabilities for higher external statics (due to the ductwork design in the building), enhanced dehumidification capabilities due to local weather conditions and other system related features. They can also include system features for overall annual efficiency improvement like economizers, energy recovery, evaporative cooling, ventilation air requirements, and enhanced IAQ features and filtration.

Many of these features are addressed in building efficiency standards or programs where the building efficiency or energy consumption calculations compensate for total building energy consumption, including HVAC products having features such as economizers, energy recovery, fan power, and indoor air quality (IAQ) treatment.

G3 Configuration Requirements. For the purpose of Standard Ratings, units shall be configured for testing as defined in this Appendix.

G3.1 Basic Model. A Basic Model means all systems within a single equipment class and which has the same or comparably performing compressor(s), condensing coil(s), evaporator coil(s), and Air Moving System(s) that have a common “nominal” cooling capacity.

G3.2 Indoor Airside Configuration. A unit for test shall be configured with a standard blower, motor and sheave/drive combination. A high static indoor blower/oversized motor is an indoor fan assembly including a motor that drives the fan, that can deliver higher external static pressure than the standard indoor fan assembly sold with the equipment. For standard ratings the unit shall be configured with the lowest NEMA efficiency class motor being offered for that model or model group.

G3.3 IAQ Features and Filtration.

G3.3.1 Filtration. High efficiency air filtration is an assembly of air filters and filter brackets or racks that provide greater air filtration than the air filtration assembly available for sale with the equipment that provides the lowest level of air filtration. Units shall be tested with manufacturer standard filters, or have an adjustment to the tested external static pressure (refer to Table 11) if no filters are present. If a unit has high efficiency air filtration, the air filters and filter brackets or rack assembly shall be removed and the unit shall be tested with the adjustment to the tested external static pressure.

G3.3.2 UV Lights. A lighting fixture and lamp mounted so that it shines light on the indoor coil that emits ultraviolet light to inhibit growth of organisms on the indoor coil surfaces, the condensate drip pan, and other locations within the equipment. Standard efficiency ratings shall be based on performance without UV Lights unless that feature is not optional.

G3.4 System Features Excluded from Testing. These products can have many features that enhance the operation of the unit on an annualized basis. Standards like ANSI/ASHRAE Standard 90.1 include performance allowances and prescriptive requirements for many of these features. Standard efficiency ratings shall be based on performance without the following features unless that feature is not optional.

G3.4.1 Economizers. An economizer is an automatic system that enables a cooling system to use outdoor air to reduce or eliminate the need for mechanical cooling during mild or cold weather. Economizers provide significant energy efficiency improvements on an annualized basis, but are also a function of regional ambient conditions and are not considered in the SEER or IEER metric.

G3.4.2 *Ventilation Energy Recovery System (VERS)*. An assembly that preconditions outdoor air entering the equipment through direct or indirect thermal and/or moisture exchange with the exhaust air, which is defined as the building air being exhausted to the outside from the equipment. Also known as exhaust air energy recovery. Energy recovery devices recover energy from the ventilation or exhaust air and provide significant annualized energy efficiency improvements depending on the regional ambient and building operating load conditions. They are not considered in the SEER or IEER metric and are addressed separately by AHRI Guideline V.

G3.4.3 *Indirect/Direct Evaporative Cooling of Ventilation Air*. Water is used to cool Outdoor Air Supply (OAS) without adding moisture to the airstream using a heat exchanger with dry and wet side. This is referred to as “indirect” evaporative cooling. In very dry climates moisture can be added by a “direct” evaporative section to further reduce the OAS dry bulb temperature. This feature has limited applicability at the standard rating conditions and is intended for dry climates where significant performance improvements are obtained.

G3.4.4 *Evaporative Pre-cooling of Condenser Intake Air*. Water is evaporated into the air entering the air cooled condenser to lower the dry bulb temperature and thereby increase efficiency of the refrigeration cycle. This feature has limited applicability at the standard rating conditions and is intended for dry climates.

G3.4.5 *Desiccant Dehumidification Components*. An assembly that reduces the moisture content of the supply air through moisture transfer with solid or liquid desiccants.

G3.4.6 *Steam/Hydronic Heat Coils*. A heat exchanger located inside the equipment that heats the equipment’s supply or outdoor air using heat delivered by steam or hot water.

G3.4.7 *Hot Gas Reheat Coils*. A heat exchanger located downstream of the indoor coil that heats the supply air during cooling operation using high pressure refrigerant in order to increase the ratio of moisture removal to cooling capacity provided by the equipment.

G3.4.8 *Powered Exhaust/Powered Return Air Fans*. A Powered Exhaust Fan is a fan that transfers directly to the outside a portion of the building air that is returning to the unit, rather than allowing it to recirculate to the indoor coil and back to the building. A Powered Return Fan is a fan that draws building air into the equipment.

G3.4.9 *Customer System Features*. These features shall not be tested, unless the unit is not offered for sale without the feature.

G3.4.9.1 *Coated Coils*. A coated coil is an optional coil coating that is selected to provide excellent resistance and durability to corrosive effects of alkalis, acids, alcohols, petroleum, seawater, salty air, and other corrosive environments. Typical processes include baked phenolic, cathodic epoxy type electrodeposition coating or thermoset vinyl coating that is bonded after coil is assembled covering the coil; tubes, headers and fin surface. Coils can be assembled from fin stock that has been coated prior to the fin stamping process. Corrosion durability shall be confirmed through testing per ASTM Standard B117 or ASTM Standard G85 Salt Spray test to a minimum of 500 hours.

G3.4.9.2 *Power Correction Capacitors*. A capacitor that increases the power factor measured at the line connection to the equipment. These devices are a requirement of the power distribution system supplying the unit.

G3.4.9.3 *Hail Guards*. A grille or similar structure mounted to the outside of the unit covering the Outdoor Coil to protect the coil from hail, flying debris and damage from large objects.

G3.4.9.4 *Indoor or Outdoor Fan Motor with Variable Frequency Drive (VFD)*. A device connected electrically between the equipment’s power supply connection and the fan motor that can vary the frequency of power supplied to the motor in order to allow variation of the motor’s rotational speed. This is commonly used for convenience of quickly setting up constant airflow.

G3.4.9.5 *Compressor VFD*. A device connected electrically between the equipment’s power supply connection and the compressor that can vary the frequency of power supplied to the

compressor in order to allow variation of the compressor's rotational speed. This is commonly used for capacity control.

G3.4.9.6 *Condenser Fan Motor Options.* A condenser fan/motor assembly designed for optional external ducting of condenser air that provides greater pressure rise and has a higher rated motor horsepower than the condenser fan provided as a standard component with the equipment.

G3.4.9.7 *Sound Traps/Sound Attenuators.* An assembly of structures through which the supply air passes before leaving the equipment or through which the return air from the building passes immediately after entering the equipment for which the sound insertion loss is at least 6 dB for the 125 Hz octave band frequency range.

G3.4.9.8 *Fire/Smoke/Isolation Dampers.* A damper assembly including means to open and close the damper mounted at the supply or return duct opening of the equipment. Such a damper shall be rated by an appropriate test laboratory according to the appropriate safety standard, such as UL Standard 555 or UL Standard 555S.

G3.4.9.9 *Desuperheater.* A heat exchanger that provides water heating external to the unit with the hot refrigerant gas from the compressor.

G3.4.9.10 *Process Heat Recovery/Reclaim Coils/Thermal Storage.* A heat exchanger located inside the equipment that conditions the equipment's supply air using energy transferred from an external source using a vapor, gas, or liquid.

G3.5 *Dampers.* Standard ratings for basic models are determined without dampers. If a sample has dampers while being tested, the dampers shall be fully sealed to prevent operation and air leakage.

G3.5.1 *Barometric Relief Dampers.* An assembly with dampers and means to automatically set the damper position in a closed position and one or more open positions to allow venting directly to the outside a portion of the building air that is returning to the unit, rather than allowing it to recirculate to the indoor coil and back to the building. For Standard Ratings, Barometric Relief Dampers shall be fully sealed.

G3.5.2 *Fresh Air Dampers.* An assembly with dampers and means to set the damper position in a closed and one open position to allow air to be drawn into the equipment when the indoor fan is operating. For Standard Ratings, Fresh Air Dampers shall be fully sealed.

APPENDIX H. EXAMPLES OF IEER CALCULATIONS - INFORMATIVE

H1 *RESERVED FOR EXAMPLE OF IEER CALCULATIONS.*

APPENDIX I. OFF-MODE TESTING - NORMATIVE

II Laboratory Testing to Determine Off-mode Average Power Ratings.

Voltage tolerances: As a percentage of reading, test operating tolerance shall be 2.0% and test condition tolerance shall be 1.5%.

Power Measurement Tolerance: Power measurements shall utilize equipment accurate to within 1% or 0.5W whichever is greater.

Conduct one of the following tests: If the central air-conditioner or heat pump lacks a compressor Crankcase Heater, perform the test in Section II.1 of this appendix; if the central air-conditioner or heat pump has a compressor Crankcase Heater that lacks controls and is not self-regulating, perform the test in Section II.1 of this appendix; if the central air-conditioner or heat pump has a Crankcase Heater with a fixed power input controlled with a thermostat that measures ambient temperature and whose sensing element temperature is not affected by the heater, perform the test in Section II.1 of this appendix; if the central air-conditioner or heat pump has a compressor Crankcase Heater equipped with self-regulating control or with controls for which the sensing element temperature is affected by the heater, perform the test in Section II.2 of this appendix.

II.1 This test determines the off-mode average power rating for central air-conditioners and heat pumps that lack a compressor Crankcase Heater, or have a compressor crankcase heating system that can be tested without control of ambient temperature during the test. This test has no ambient condition requirements.

II.1.1 *Test Sample Set-up and Power Measurement.* For Coil-only Systems, provide a furnace or Modular Blower that is compatible with the system to serve as an interface with the thermostat (if used for the test) and to provide low-voltage control circuit power. Make all control circuit connections between the furnace (or Modular Blower) and the Outdoor Unit as specified by the Installation Instructions. Measure power supplied to both the furnace or Modular Blower and power supplied to the Outdoor Unit. Alternatively, provide a compatible transformer to supply low-voltage control circuit power, as described in Section II.4 of this Appendix. Measure transformer power, either supplied to the primary winding or supplied by the secondary winding of the transformer, and power supplied to the Outdoor Unit. For blower coil and single-package systems, make all control circuit connections between components as specified by the Installation Instructions, and provide power and measure power supplied to all system components.

II.1.2 *Configure Controls.* Configure the controls of the central air-conditioner or heat pump so that it operates as if connected to a building thermostat that is set to the OFF position. Use a compatible building thermostat if necessary to achieve this configuration. For a thermostat-controlled Crankcase Heater with a fixed power input, bypass the Crankcase Heater thermostat if necessary to energize the heater.

II.1.3 *Measure P_{2x} .* If the unit has a Crankcase Heater time delay, make sure that time delay function is disabled or wait until delay time has passed. Determine the average power from non-zero value data measured over a 5- minute interval of the non-operating central air-conditioner or heat pump and designate the average power as P_{2x} , the heating season total off-mode power.

II.1.4 *Measure P_x .* For Coil-only Systems and for Blower Coil Systems for which a furnace or a Modular Blower is the designated air mover: Disconnect all low- voltage wiring for the outdoor components and outdoor controls from the low-voltage transformer. Determine the average power from non-zero value data measured over a 5- minute interval of the power supplied to the (remaining) low-voltage components of the central air-conditioner or heat pump, or low- voltage power, P_x . This power measurement does not include line power supplied to the Outdoor Unit. It is the line power supplied to the air mover, or, if a compatible transformer is used instead of an air mover, it is the line power supplied to the transformer primary coil. If a compatible transformer is used instead of an air mover and power output of the low-voltage secondary circuit is measured, P_x is zero.

II.1.5 *Calculate P_2 .* Set the number of compressors (n_c) equal to the unit's number of single-stage compressors (n_s) plus 1.75 times the unit's number of compressors that are not single-stage (n_v).

$$n_c = n_s + (1.75 \cdot n_v)$$

For Single Package Units and Blower Coil Systems for which the designated air mover is not a furnace or Modular Blower, divide the heating season total off-mode power (P_{2x}) by the number of compressors (n_c) to calculate $P2$, the heating season per-compressor off-mode power. Round $P2$ to the nearest watt. The expression for calculating $P2$ is as follows:

$$P2 = \frac{P_{2x}}{n_c} \quad 12$$

For Coil Only Systems and Blower Coil Systems for which a furnace or a Modular Blower is the designated air mover, subtract the low-voltage power (P_x) from the heating season total off-mode power (P_{2x}) and divide by the number of compressors (n_c) to calculate $P2$, the heating season per-compressor off-mode power. Round $P2$ to the nearest watt. The expression for calculating $P2$ is as follows:

$$P2 = \frac{P_{2x} - P_x}{n_c} \quad 13$$

11.1.6 Shoulder Season per-compressor off-mode power, $P1$: If the system does not have a Crankcase Heater, has a Crankcase Heater without controls that is not self-regulating, or has a value for the Crankcase Heater turn-on temperature (as certified in the DOE Compliance Certification Database) that is higher than 71 °F, then $P1$ is equal to $P2$.

Otherwise, de-energize the Crankcase Heater (by removing the thermostat bypass or otherwise disconnecting only the power supply to the Crankcase Heater) and repeat the measurement as described in section 11.1.3 of this appendix. Designate the measured average power as P_{1x} , the Shoulder Season total off-mode power.

Determine the number of compressors (n_c) as described in section 11.1.5 of this appendix

For Single Package Units and Blower Coil Systems for which the designated air mover is not a furnace or Modular Blower, divide the Shoulder Season total off-mode power (P_{1x}) by the number of compressors (n_c) to calculate $P1$, the Shoulder Season per-compressor off-mode power. Round $P1$ to the nearest watt. The expression for calculating $P1$ is as follows:

$$P1 = \frac{P_{1x}}{n_c} \quad 14$$

For Coil-only Systems and Blower Coil Systems for which a furnace or a Modular Blower is the designated air mover, subtract the low-voltage power (P_x) from the Shoulder Season total off-mode power (P_{1x}) and divide by the number of compressors (n_c) to calculate $P1$, the Shoulder Season per-compressor off-mode power. Round $P1$ to the nearest watt. The expression for calculating $P1$ is as follows:

$$P1 = \frac{P_{1x} - P_x}{n_c} \quad 15$$

11.2 This test determines the off-mode average power rating for central air-conditioners and heat pumps for which ambient temperature can affect the measurement of Crankcase Heater power.

11.2.1 *Test Sample Set-up and Power Measurement.* Set up the test and measurement as described in Section 11.1.1 of this appendix.

11.2.2 *Configure Controls.* Position a temperature sensor to measure the outdoor dry-bulb temperature in the air between 2 and 6 in from the Crankcase Heater control temperature sensor or, if no such temperature sensor exists, position it in the air between 2 and 6 in from the Crankcase Heater. Utilize the temperature measurements from this sensor for this portion of the test procedure. Configure the controls of the central air-conditioner or heat pump so that it operates as if connected to a building thermostat that is set to the OFF position. Use a compatible building thermostat if necessary to achieve this configuration.

Conduct the test after completion of the B_{Full} or B_{Low} test. Alternatively, start the test when the outdoor dry-bulb temperature is at 82 °F and the temperature of the compressor shell (or temperature of each compressor's shell if there is more than one compressor) is at least 81 °F. Then adjust the outdoor temperature at a rate of change of no more than 20 °F per hour and achieve an outdoor dry-bulb temperature of 72 °F. Maintain this

temperature within ± 2 °F while making the power measurement, as described in Section 11.2.3 of this appendix.

11.2.3 *Measure $P1_x$.* If the unit has a Crankcase Heater time delay, make sure that time delay function is disabled or wait until delay time has passed. Determine the average power from non-zero value data measured over a 5- minute interval of the non-operating central air-conditioner or heat pump and designate the average power as $P1_x$, the Shoulder Season total off-mode power. For units with Crankcase Heater which operate during this part of the test and whose controls cycle or vary Crankcase Heater power over time, the test period shall consist of three complete Crankcase Heater cycles or 18 hours, whichever comes first. Designate the average power over the test period as $P1_x$, the Shoulder Season total off-mode power.

11.2.4 *Reduce Outdoor Temperature.* Approach the target outdoor dry-bulb temperature by adjusting the outdoor temperature at a rate of change of no more than 20 °F per hour. This target temperature is five degrees Fahrenheit less than the temperature specified by the OUM at which the Crankcase Heater turns on. Maintain the target temperature within ± 2 °F while making the power measurement, as described in Section 11.2.5 of this appendix.

11.2.5 *Measure $P2_x$.* If the unit has a Crankcase Heater time delay, make sure that time delay function is disabled or wait until delay time has passed. Determine the average non-zero power of the non-operating central air-conditioner or heat pump over a 5-minute interval and designate it as $P2_x$, the heating season total off-mode power. For units with Crankcase Heater whose controls cycle or vary Crankcase Heater power over time, the test period shall consist of three complete Crankcase Heater cycles or 18 hours, whichever comes first. Designate the average power over the test period as $P2_x$, the heating season total off-mode power.

11.2.6 *Measure P_x .* For Coil-only Systems and for Blower Coil Systems for which a furnace or Modular Blower is the designated air mover: Disconnect all low- voltage wiring for the outdoor components and outdoor controls from the low-voltage transformer. Determine the average power from non-zero value data measured over a 5- minute interval of the power supplied to the (remaining) low-voltage components of the central air-conditioner or heat pump, or low- voltage power, P_x . This power measurement does not include line power supplied to the Outdoor Unit. It is the line power supplied to the air mover, or, if a compatible transformer is used instead of an air mover, it is the line power supplied to the transformer primary coil. If a compatible transformer is used instead of an air mover and power output of the low-voltage secondary circuit is measured, P_x is zero.

11.2.7 *Calculate $P1$.* Set the number of compressors (n_c) equal to the unit’s number of single-stage compressors (n_s) plus 1.75 times the unit’s number of compressors that are not single-stage (n_v).

For Single Package Units and Blower Coil Systems for which the air mover is not a furnace or Modular Blower, divide the Shoulder Season total off-mode power ($P1_x$) by the number of compressors (n_c) to calculate $P1$, the Shoulder Season per-compressor off-mode power. Round to the nearest watt. The expression for calculating $P1$ is as follows:

$$P1 = \frac{P1_x}{n_c} \tag{16}$$

For Coil-only Systems and Blower Coil Systems for which a furnace or a Modular Blower is the designated air mover, subtract the low-voltage power (P_x) from the Shoulder Season total off-mode power ($P1_x$) and divide by the number of compressors (n_c) to calculate $P1$, the Shoulder Season per- compressor off-mode power. Round to the nearest watt. The expression for calculating $P1$ is as follows:

$$P1 = \frac{P1_x - P_x}{n_c} \tag{17}$$

11.2.8 *Calculate $P2$.* Determine the number of compressors (n_c) as described in Section 11.2.7 of this appendix.

For Single Package Units and Blower Coil Systems for which the air mover is not a furnace, divide the heating season total off-mode power ($P2_x$) by the number of compressors (n_c) to calculate $P2$, the heating season per-compressor off-mode power. Round to the nearest watt. The expression for calculating $P2$ is as follows:

$$P2 = \frac{P2_x}{n_c} \quad 18$$

For Coil-only Systems and Blower Coil Systems for which a furnace or a Modular Blower is the designated air mover, subtract the low-voltage power (P_x) from the heating season total off-mode power ($P2_x$) and divide by the number of compressors (n_c) to calculate $P2$, the heating season per-compressor off-mode power. Round to the nearest watt. The expression for calculating $P2$ is as follows:

$$P2 = \frac{P2_x - P_x}{n_c} \quad 19$$

11.3 When testing a Coil-only System, install a toroidal-type transformer to power the system's low-voltage components, complying with any additional requirements for the transformer mentioned in the Installation Instructions included with the unit by the OUM. If the Installation Instructions do not provide specifications for the transformer, use a transformer having the following features:

11.3.1 A nominal volt-amp rating such that the transformer is loaded between 25% and 90% of this rating for the highest level of power measured during the off-mode test;

11.3.2 Designed to operate with a primary input of 230 V, single phase, 60 Hz; and

11.3.3 That provides an output voltage that is within the specified range for each low-voltage component. Include the power consumption of the components connected to the transformer as part of the total system power consumption during the off-mode tests; do not include the power consumed by the transformer when no load is connected to it.

APPENDIX J. VERIFICATION TESTING - NORMATIVE

J1 To comply with this standard, single sample production verification tests shall meet the certified Standard Rating performance metrics shown in Table J1 with the listed acceptance criteria.

Table J1. Acceptance Criteria	
Performance Metric	Acceptance Criteria
Cooling Metrics	
Capacity ¹	≥ 95%
SEER	≥ 95%
EER _{A,Full}	≥ 95%
IEER	≥ 90%
Heating Metrics	
Capacity ²	≥ 95%
HSPF	≥ 95%
Notes: 1. Cooling capacity at A _{Full} conditions 2. Heating capacity at H1 _{Full} or H1 _{Nom} conditions, as appropriate.	

APPENDIX K. DOE APPENDIX M1 - INFORMATIVE

K1 DOE Appendix M1 to Subpart B of 10 CFR 430.

For information only to the user of this version of AHRI Standard 210/240, several changes to the federal test procedure will become effective January 1, 2023. These changes, as they will impact AHRI Standard 210/240, are listed below.

K1.1 Metric Changes. The metrics listed throughout the Standard will change as noted below.

K.1.1.1 EER will become EER2.

K.1.1.2 SEER will become SEER2.

K.1.1.3 HSPF will become HSPF2.

K1.2 New Classifications for Indoor Units. Minimum external static pressure during test and default power consumption for coil-only systems will change as a function of the indoor unit. Therefore, there will be new definitions as listed below which will be added to Section 3 of this Standard.

K.1.2.1 Ceiling-mount Blower Coil System. A split system for which a) the outdoor unit has a certified cooling capacity less than or equal to 36,000 Btu/h; b) the indoor unit(s) is/ are shipped with manufacturer-supplied installation instructions that specify to secure the indoor unit only to the ceiling, within a furred-down space, or above a dropped ceiling of the conditioned space, with return air directly to the bottom of the unit without ductwork, or through the furred-down space, or optional insulated return air plenum that is shipped with the indoor unit; c) the installed height of the indoor unit is no more than 12 in (not including condensate drain lines) and the installed depth (in the direction of airflow) of the indoor unit is no more than 30 in; and d) supply air is discharged horizontally.

K.1.2.2 Low-static Blower Coil System. A ducted multi-split or multi-head mini-split system for which all indoor units produce greater than 0.01 in. wc. and a maximum of 0.35 in. wc. external static pressure when operated at the cooling full-load air volume rate not exceeding 400 cfm per rated ton of cooling.

K.1.2.3 Mid-static Blower Coil System. A ducted multi-split or multi-head mini-split system for which all indoor units produce greater than 0.20 in. wc. and a maximum of 0.65 in. wc. when operated at the cooling full-load air volume rate not exceeding 400 cfm per rated ton of cooling.

K.1.2.4 Minimum-speed-limiting Variable-speed Heat Pump. A heat pump for which the compressor speed (represented by revolutions per minute or motor power input frequency) is higher than its value for operation in a 47 °F ambient temperature for any bin temperature (T_j) for which the calculated heating load is less than the calculated intermediate-speed capacity.

K.1.2.5 Mobile Home Blower Coil System. A split system that contains an outdoor unit and an indoor unit that meet the following criteria:

(1) Both the indoor and outdoor unit are shipped with manufacturer-supplied installation instructions that specify installation only in a mobile home with the home and equipment complying with HUD Manufactured Home Construction Safety Standard 24 CFR Part 3280;

(2) The indoor unit cannot exceed 0.40 in. wc. when operated at the cooling full-load air volume rate not exceeding 400 cfm per rated ton of cooling; and

(3) The indoor and outdoor unit each shall bear a label in at least 1/4 inch font that reads “For installation only in HUD manufactured home per Construction Safety Standard 24 CFR Part 3280.”

K.1.2.6 Mobile Home Coil-only System. A coil only split system that includes an outdoor unit and coil-only indoor unit that meet the following criteria:

(1) The outdoor unit is shipped with manufacturer-supplied installation instructions that specify installation only for mobile homes that comply with HUD Manufactured Home Construction Safety Standard 24 CFR Part 3280,

(2) The coil-only indoor unit is shipped with manufacturer-supplied installation instructions that specify installation only in or with a mobile home furnace, modular blower, or designated air mover that complies with HUD Manufactured Home Construction Safety Standard 24 CFR Part 3280, and has dimensions no greater than 20 in wide, 34 in high and 21 in deep, and

(3) The coil-only indoor unit and outdoor unit each has a label in at least 1/4 in font that reads “For installation only in HUD manufactured home per Construction Safety Standard 24 CFR Part 3280.”

K1.2.7 *Wall-mount Blower Coil System.* A split system air conditioner or heat pump for which:

(a) The outdoor unit has a certified cooling capacity less than or equal to 36,000 Btu/h;

(b) The indoor unit(s) is/are shipped with manufacturer-supplied installation instructions that specify mounting only by:

(1) Securing the back side of the unit to a wall within the conditioned space, or

(2) Securing the unit to adjacent wall studs or in an enclosure, such as a closet, such that the indoor unit’s front face is flush with a wall in the conditioned space;

(c) Has front air return without ductwork and is not capable of horizontal air discharge; and

(d) Has a height no more than 45 in, a depth (perpendicular to the wall) no more than 22 in (including tubing connections), and a width no more than 24 in (parallel to the wall).

K1.3 *New Default Power for Coil-only Systems.* The existing default power consumption, 365 watts per 1,000 scfm, will change to 441 watts per 1,000 scfm for all Coil-only Systems except Mobile home Coil-only Systems, which will change to 406 watts per 1,000 scfm in the following locations in this Standard: Section 6.1, Equation 11.16, Equation 11.26 and Equation 11.52.

K1.4 *New Minimum External Static Pressure.* Table 11 will be modified to have new minimum external static pressures as noted below.

K1.4.1 Conventional blower coil system – 0.50 in wc.

K1.4.2 Ceiling-mount blower coil system – 0.30 in wc.

K1.4.3 Wall-mount blower coil system – 0.30 in wc.

K1.4.4 Low-static blower coil system – 0.10 in wc.

K1.4.5 Mid-static blower coil system – 0.30 in wc.

K1.4.6 Conventional blower coil system – 0.50 in wc.

K1.5 *Heat Pump HSPF2 Calculation Changes.* Several changes will affect the calculated Heating Seasonal Performance Factor as noted below.

K1.5.1 The zero-load point for heating changes from a single value of 65 °F for all regions to a different value for each region. Further, the heating load line values will change, also from a single value for all regions to a different value depending upon the region as well as the type of equipment. Thus Table 18 of this Standard will be updated to match Table 20 of the M1 federal test procedure as published at 82 Fed. Reg. 1576 (see Table K1) .

Region Number	I	II	III	IV	V	VI
Heating Load Hours	493	857	1247	1701	2202	1842
Outdoor Design Temperature (T _{OD}), °F	37	27	17	5	-10	30
Heating Load Line Equation Slope Factor (C)	1.10	1.06	1.30	1.15	1.16	1.11
Variable-speed Slope Factor (C _{VS})	1.03	0.99	1.21	1.07	1.08	1.03
Zero-Load Temperature (T), °F	58	57	56	55	55	57
j	t, °F	Fractional Bin Hours, n _j /N				
1	62	0	0	0	0	0
2	57	0.239	0	0	0	0

3	52	0.194	0.163	0.138	0.103	0.086	0.215
4	47	0.129	0.143	0.137	0.093	0.076	0.204
5	42	0.081	0.112	0.135	0.100	0.078	0.141
6	37	0.041	0.088	0.118	0.109	0.087	0.076
7	32	0.019	0.056	0.092	0.126	0.102	0.034
8	27	0.005	0.024	0.047	0.087	0.094	0.008
9	22	0.001	0.008	0.021	0.055	0.074	0.003
10	17	0	0.002	0.009	0.036	0.055	0
11	12	0	0	0.005	0.026	0.047	0
12	7	0	0	0.002	0.013	0.038	0
13	2	0	0	0.001	0.006	0.029	0
14	-3	0	0	0	0.002	0.018	0
15	-8	0	0	0	0.001	0.010	0
16	-13	0	0	0	0	0.005	0
17	-18	0	0	0	0	0.002	0
18	-23	0	0	0	0	0.001	0

K1.5.2 A new optional test for lower ambient temperatures will be permitted, H4_{Full}, and will be added to Table 8 and Table 9 of this Standard. Equations for HSPF, in Section 11.2.2 of this Standard will be updated for to use the results of this optional test.

K1.5.3 Further modifications to calculations affection Variable Speed Systems will require changes to equations in Section 11.2.1.3 and Section 11.2.2.3.

K1.6 *Standby Mode Test Procedure.* Section I1.2 of this standard (Section 3.13.2 of the Federal Test Procedure) will change to require a minimum 4 hour period for temperature stabilization for products without a compressor sound blanket and a minimum of 8 hour period if a compressor sound blanket is present.