

AHRI Standard 921 (SI)

**2020 Standard for
Performance Rating of
Direct Expansion-Dedicated
Outdoor Air System Units**



**AIR-CONDITIONING, HEATING,
& REFRIGERATION INSTITUTE**

we make life better®

2311 Wilson Boulevard, Suite 400
Arlington, VA 22201, USA
www.ahrinet.org
PH 703.524.8800
FX 703.562.1942

IMPORTANT

SAFETY DISCLAIMER

AHRI does not set safety standards and does not certify or guarantee the safety of any products, components or systems designed, tested, rated, installed or operated in accordance with this standard/guideline. It is strongly recommended that products be designed, constructed, assembled, installed and operated in accordance with nationally recognized safety standards and code requirements appropriate for products covered by this standard/guideline.

AHRI uses its best efforts to develop standards/guidelines employing state-of-the-art and accepted industry practices. AHRI does not certify or guarantee that any tests conducted under its standards/guidelines will be non-hazardous or free from risk.

Note:

This standard supersedes ANSI/AHRI Standard 921 (SI)-2015.

For I-P ratings, see AHRI Standard 920 (SI-P)-2020.

AHRI CERTIFICATION PROGRAM PROVISIONS

The current scope of the Direct Expansion – Dedicated Outdoor Air System Units (DX-DOAS) Units Certification Program can be found on AHRI's website at this link: <http://www.ahrinet.org/Certification/AHRI-Certification-Programs/DX-Dedicated-Outdoor-Air-System-Units>

Foreword:

DX-DOAS condition Outdoor Ventilation Air independently from the building HVAC system. This approach to handling ventilation air results in superior humidity control by limiting the primary source of humidity in most buildings – ambient humidity carried in by the ventilation air – directly at its source. When the DX-DOAS removes enough moisture from the ventilation air to match the building interior load, energy savings can be obtained by running the separate, sensible cooling only, interior cooling system at a higher evaporating temperature, thus improving the energy efficiency. Further energy savings may be realized by providing only the amount of ventilation air necessary and/or by using energy recovery from the building Exhaust Air to pre-treat the ventilation air. Alternate energy strategies may be employed to provide ventilation air at low or high dry bulb temperatures to assist in building cooling and heating.

<u>SECTION</u>	TABLE OF CONTENTS	<u>PAGE</u>
Section 1.	Purpose.....	1
Section 2.	Scope.....	1
Section 3.	Definitions.....	1
Section 4.	Classifications.....	5
Section 5.	Test Requirements	6
Section 6.	Rating Requirements.....	9
Section 7.	Minimum Data Requirements.....	23
Section 8.	Operating Requirements.....	23
Section 9.	Marking and Nameplate Data.....	25
Section 10.	Conformance Requirements	25
Section 11.	Symbols and Subscripts.....	25

TABLES

Table 1.	Classification of DX-DOAS Units.....	6
Table 2.	Test Condition Tolerance for Charging Hierarchy.....	8
Table 3.	Multiples for Rated MRC.....	10
Table 4.	Operating Conditions for Standard Rating and Performance Tests for Classifications A,B, W .	11
Table 5.	Operating Conditions for Standard Rating and Performance Tests for Classification H.....	12
Table 6.	Multiples for Rated Airflow	14
Table 7.	External Static Pressures	15
Table 8.	Basic Pumping Penalty (PP _B) vs. Liquid Flow Rate (WF)	16
Table 9.	Test Operating and Test Condition Tolerances.....	17
Table 10.	Heating Capacity Tests.....	20
Table 11.	Supply Air Temperatures and W Penalty Used for Calculation of Heating Mode Ratings	21

FIGURES

Figure 1	DX-DOAS Unit Airflow Schematic.....	2
----------	-------------------------------------	---

APPENDICES

Appendix A	References – Normative	28
Appendix B	References – Informative	29
Appendix C	ANSI/ASHRAE Standard 198 and ANSI/ASHRAE Standard 37 Additions Clarifications and Exceptions – Normative.....	30

Appendix D	MRE and COP Interpolation Calculations – Informative.....	46
Appendix E	Typical Test Unit Installations – Informative.....	56
Appendix F	Unit Configuration for Standard Efficiency Determination – Normative.....	63
Appendix G	Verification Testing – Normative.....	66

TABLES FOR APPENDICES

Table C1	Outdoor Coil Entering Air Conditions for Air-Cooled and Evaporatively-Cooled DX-DOAS Units.....	30
Table C2	Temperature Measurement Requirements.....	34
Table C3	Criteria for Air Distribution and Control of Air Temperature.....	41
Table C4	Default VERS Performance Values.....	43
Table D1	MRE Weighted Average Calculation Example 1; Tested Values.....	46
Table D2	MRE Weighted Average Calculation Example 2; Tested Values.....	49
Table D3	COP Weighted Average Calculation Example 1; Tested Values.....	52
Table D4	COP Weighted Average Calculation Example 2; Tested Values.....	54
Table G1	Acceptance Criteria.....	66

FIGURES FOR APPENDICES

Figure C1	Non-Ducted Outlet Plenum.....	32
Figure C2	Non-Ducted Inlet Plenum (Without Ducting to Booster Fan).....	33
Figure C3	Aspirating Psychrometer.....	34
Figure C4	Typical Air Sampling Tree.....	36
Figure C5	Determination of Measurement Rectangles and Required Number of Air Sampler Trees.....	37
Figure C6	Typical Test Setup Configurations.....	38
Figure E1	Single Package DX-DOAS Laboratory Schematic (No VERS).....	56
Figure E2	Single Package DX-DOAS unit with Desiccant Wheel Laboratory Schematic (No VERS).....	57
Figure E3	Single Package DX-DOAS unit with VERS (Option 1, 2 Rooms).....	58
Figure E4	Single Package DX-DOAS unit with VERS (Option 1, 3 Rooms).....	59
Figure E5	Single Package DX-DOAS unit with Desiccant Wheel (Option 1, 3 Rooms).....	60
Figure E6	Single Package DX-DOAS with VERS (Option 2).....	61
Figure E7	Relief-Air-Cooled DX-DOAS with or without VERS (Option 1).....	62

PERFORMANCE RATING OF DIRECT EXPANSION-DEDICATED OUTDOOR AIR SYSTEM UNITS

Section 1. Purpose

1.1 Purpose. The purpose of this standard is to establish for Direct Expansion-Dedicated Outdoor Air System (DX-DOAS) Units: definitions; classifications; test requirements; rating requirements; minimum data requirements for Published Ratings; operating requirements; marking and nameplate data; and conformance conditions.

1.1.1 Intent. This standard is intended for the guidance of the industry, including manufacturers, engineers, installers, contractors and users.

1.1.2 Review and Amendment. This standard is subject to review and amendment as technology advances.

Section 2. Scope

2.1 Scope. This standard applies to factory-assembled commercial or industrial DX-DOAS Units as defined in Section 3.

2.1.1 Energy Source. This standard only applies to electrically operated, vapor-compression refrigeration systems.

2.1.2 Installation. DX-DOAS Units are intended for ducted or non-ducted installation with field or factory supplied grilles.

2.2 Exclusions. This standard shall not apply to Sensible-only 100% Outdoor Air Units. Direct conversion of values from testing performed under AHRI Standard 921 (SI) shall not be used.

Section 3. Definitions

All terms in this document will follow the standard industry definitions in the ASHRAE Terminology website (<https://www.ashrae.org/resources--publications/free-resources/ashrae-terminology>) unless otherwise defined in this section.

3.1 Air Conditions.

3.1.1 Exhaust Air. Air removed from the DX-DOAS Unit after use (a) for preconditioning Outdoor Air in a VERS, (b) as a heat sink or source for an Outdoor Coil, or (c) both, and discharged outside the building by means of mechanical ventilation systems. This is only applicable to DX-DOAS units with VERS and Relief-Air-Cooled DX-DOAS units.

3.1.2 Outdoor Air. Unconditioned air from outside a building taken from the external atmosphere.

3.1.3 Outdoor Ventilation Air. The Outdoor Air that passes through the conditioning coil and is supplied to the conditioned space.

3.1.4 Regeneration Air. Outdoor Air drawn into the DX-DOAS Unit that is used to remove moisture from the desiccant and is exhausted to the building exterior, rather than to the Conditioned Space.

3.1.5 Return Air. Air removed from the Conditioned Space and delivered to the DX-DOAS Unit by means of mechanical ventilation systems. This air is used to precondition Outdoor Air in a VERS or act as a heat sink or source for an Outdoor Coil.

3.1.6 Simulated Ventilation Air. Air that is representative of the pre-conditioned air leaving the Ventilation Energy Recovery System (VERS) when using test Option 2, as described in Section 5.4.

3.1.7 Supply Air. Conditioned air discharged from the DX-DOAS Unit and delivered to the Conditioned Space.

3.2 Airflow.

3.2.1 Exhaust Airflow. The moving volume of exhaust air discharged outside the building. Exhaust Airflow is expressed in m^3/s (see Figure 1).

3.2.2 Outdoor Airflow. The moving volume of Outdoor Air that enters and is conditioned by the DX-DOAS Unit. Outdoor Airflow is expressed in m^3/s (see Figure 1).

3.2.3 Regeneration Airflow. The moving volume of Outdoor Air that is drawn into the DX-DOAS Unit, is used to remove moisture from the desiccant, and is exhausted to the building exterior, rather than to the Conditioned Space.

3.2.4 Return Airflow. The moving volume of Return Air entering the DOAS. Return Airflow is expressed in m^3/s (see Figure 1).

3.2.5 Simulated Ventilation Airflow. The moving volume of Simulated Ventilation Air that is ducted to the Outdoor Air inlet and the Return Air inlet during Option 2 testing as described in Figure E6.

3.2.6 Supply Airflow. The moving volume of Supply Air delivered by the DX-DOAS Unit by the unit-mounted Supply Air fan or fans. Supply Airflow is expressed as m^3/s (see Figure 1).

3.2.6.1 Rated Supply Airflow. The Supply Airflow used when setting Airflow, as described in Section 6.1.5.

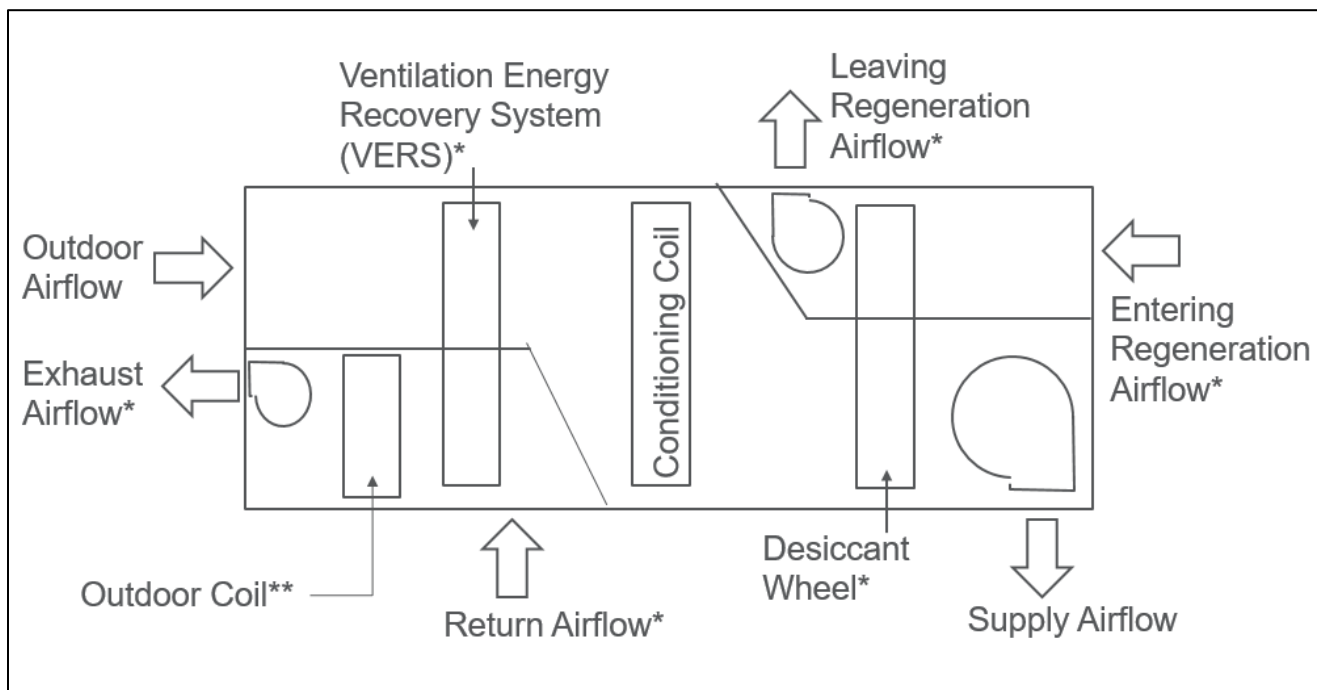

* - Denotes components of a DX-DOAS unit that may not be present in all testing arrangements.
 ** - This outdoor coil location applicable only for a Relief-Air-Cooled DX DOAS arrangement. May be present in this location in a unit with or without VERS. Otherwise, the outdoor coil is in a separate location exposed to flow of outdoor air.

Figure 1. DX-DOAS Units Airflow Schematic.

3.3 Coefficient of Performance (COP). A ratio of the heating capacity in watts to the power input values in watts at any given set of Rating Conditions expressed in W/W.

3.3.1 $COP_{DOAS,x}$. The COP of the DX-DOAS Unit determined by the Total Heating Capacity – DOAS and the unit’s electrical input power at the corresponding compressor capacity control that provides, or most closely provides, a Supply Air dry bulb temperature within the allowed Supply Air dry bulb temperature range (where x signifies the Standard Rating Condition).

3.4 *Conditioned Space.* That part of a building that is humidified or dehumidified; heated or cooled, or both, for the comfort of occupants.

3.5 *Conditioning Coil.* The coil that uses evaporating refrigerant to cool and dehumidify the Outdoor Ventilation Air in a DX-DOAS without a Ventilation Energy Recovery System (VERS) or to cool and dehumidify the air leaving the energy recovery device in a DX-DOAS with energy recovery.

3.6 *Direct Expansion-Dedicated Outdoor Air System Units (DX-DOAS or DX-DOAS Units).* A type of air-cooled, evaporatively-cooled, or water-cooled air-conditioner, or an air-source or water source heat pump, that is a factory assembled product designed and marketed and sold to provide ventilation and dehumidification of 100 % Outdoor Air, is capable of dehumidifying air to a 12.8 °C dew point when operating under Standard Rating Condition A as specified in Table 4 or Table 5 of this test standard with a barometric pressure of 101.3 kPa, and may include Reheat. It may include pre-conditioning of Outdoor Air using an enthalpy wheel, sensible wheel, desiccant wheel, plate heat exchanger, heat pipes, or other heat or mass transfer apparatus. Heating components are optional and may include electrical resistance, steam, hot water, or gas heat. In addition, it may provide for air cleaning or may include mixing box or economizer dampers to allow Return Air to be intermittently used as allowed by the controls.

3.6.1 *Outdoor-Air-Cooled DX-DOAS.* An air-cooled DX-DOAS unit which uses 100% outdoor air to cool the Outdoor Coil in dehumidification mode.

3.6.2 *Relief-Air-Cooled DX-DOAS.* An air-cooled DX-DOAS unit which cools or warms the outdoor coil using either (a) 100% Return Air, or (b) the air leaving a VERS after pre-conditioning the entering Outdoor Air.

3.7 *Energy Recovery Wheel.* A rotating-disk VERS having a porous matrix that transfers heat and may transfer moisture between air streams passing through opposite sides of the disk. It transfers energy between the air streams by alternately contacting one and then the other air stream as it rotates.

3.8 *Exhaust Air Transfer Ratio (EATR).* The fraction of the flow of Standard Air leaving a VERS that leaked or transferred from the Return Air inlet rather than passing through the VERS from the Outdoor Air inlet.

3.9 *Full Capacity.* For compressors with Staged Capacity Control, all compressors on and are operating at maximum capacity. For compressors with Proportional Capacity Control, all compressors are on and operating at maximum capacity allowed by the factory mounted controls.

3.10 *Ground Source Closed-loop Heat Pump.* A heat pump that uses fluid circulated through a subsurface piping loop as a heat source/heat sink.

3.11 *Ground Source Heat Pump.* A heat pump that uses water pumped from a well, lake or stream as a heat source/heat sink.

3.12 *Integrated Seasonal Coefficient of Performance (ISCOP2).* A seasonal efficiency rating. A combined heating efficiency rating of a DX-DOAS heat pump at operating points E and F, as defined in Tables 4 and 5, based on the formulas listed in Section 6.12. Expressed in W/W.

3.13 *Integrated Seasonal Moisture Removal Efficiency (ISMRE2).* This seasonal efficiency rating is a combined MRE rating of a DX-DOAS Unit operating at standard rating conditions A, B, C and D as defined in Tables 4 and 5 and based on the formula listed in Section 6.13. Expressed in kg of moisture/kW·h.

3.13.1 *Integrated Seasonal Moisture Removal Efficiency 70 (ISMRE₇₀).* This seasonal efficiency rating is a combined MRE₇₀ rating of a DX-DOAS Unit operating at standard rating conditions A, B, C and D, as defined in Tables 4 and 5, and based on the formula listed in Section 6.13.

3.14 *Manufacturer's Installation Instructions (MII).* Manufacturer's documents that come packaged with or appear in the labels applied to the unit(s). Online manuals are acceptable if referenced on the unit label or in the documents that come packaged with the unit. All references to "manufacturer's instructions," "manufacturer's published instructions," "manufacturer's installation instructions," "manufacturer's published recommendations," "manufacturer installation and operation manuals," "installation instructions" and other similar references means Manufacturer's Installation Instructions.

3.14.1 Supplemental Test Instructions (STI). Additional instructions provided by the manufacturer and certified to the United States Department of Energy (DOE). STI shall include (a) all instructions that do not deviate from MII but provide additional specifications for test standard requirements allowing more than one option, and (b) all deviations from MII necessary to comply with steady state requirements. STI shall provide steady operation that matches to the extent possible the average performance that would be obtained without deviating from the MII. STI shall include no instructions that deviate from MII other than those described in (b) above.

3.15 Moisture Removal Capacity (MRC). The rate of moisture removal from air delivered by the DX-DOAS Unit as Supply Air, expressed in kg of moisture/h at the Rated Supply Airflow rate.

3.16 Moisture Removal Efficiency (MRE). A ratio of the Moisture Removal Capacity to the total power input at any given set of Rating Conditions expressed in kg of moisture per kW·h.

3.16.1 Moisture Removal Efficiency-70 (MRE₇₀). The MRE of the DX-DOAS Unit including energy usage from any Supplementary Heat that is required to raise the temperature of the Supply Air to 21.1 °C.

3.17 Outdoor Coil. The heat exchanger that operates as a condenser to reject heat from the refrigeration circuit in dehumidification mode or (for heat pump DX-DOAS) operates as an evaporator to absorb heat into the refrigeration circuit during heating mode. For the purposes of this standard, most of the Outdoor Coils have Outdoor Air passing through them, except for Relief-Air-Cooled Dx-DOAS Units.

3.18 Proportional Capacity Control. Compressor capacity control that has at least one compressor with continuously modulating capacity or multiple capacity steps where the Total Cooling Capacity for each step is not more than 5% of the sum of all the ANSI/CAN/AHRI Standard 540 Table 1, rating test capacities for high temperature refrigeration.

3.19 Published Rating. A statement of the assigned values of those performance characteristics, under stated Rating Conditions, by which a unit may be chosen to fit its application. These values apply to all units of like nominal size and type (identification) produced by the same manufacturer. The term Published Rating includes the rating of all performance characteristics shown on the unit or published in specifications, advertising or other literature controlled by the manufacturer, at stated Rating Conditions.

3.19.1 Application Rating. A rating based on tests performed at Application Rating Conditions (other than Standard Rating Conditions).

3.19.2 Standard Rating. A rating based on tests performed at Standard Rating Conditions as listed in Table 4 or Table 5 and Table 7.

3.20 Rating Conditions. Any set of operating conditions under which a single level of performance results and which causes only that level of performance to occur.

3.20.1 Standard Rating Conditions. Rating Conditions used as the basis of comparison for performance characteristics as listed in Table 4 or Table 5 and Table 7. Conditions A, B, C, D, E and F, are denoted throughout the standard using a subscript, x, in some cases.

3.21 Reheat. Sensible heat that the DX-DOAS Unit can input to the Supply Air in the dehumidification mode to raise its dry bulb temperature downstream of the conditioning coil.

3.21.1 Cycle Reheat. Heat that is used to increase the dry bulb temperature of dehumidified air leaving the evaporator that is supplied by a component that is either part of the vapor compression cycle, or a system that transfers heat from one part of the unit to the other (e.g., wrap-around heat pipe, wrap-around vapor compression cycle), or a system that transfers heat from outdoors, or air moving over the Outdoor Coil, to the dehumidified air. Cycle Reheat is not Supplementary Heat. Cycle Reheat is expressed in units of W.

3.21.2 Supplementary Reheat. Supplementary Heat used during dehumidification mode.

3.22 "Shall" or "Should". "Shall" or "should" shall be interpreted as follows:

3.22.1 Shall. Where "shall" or "shall not" is used for a provision specified, that provision is mandatory if compliance

with the standard is claimed.

3.22.2 *Should*. "Should" is used to indicate provisions which are not mandatory but which are desirable as good practice.

3.23 *Staged Capacity Control*. Compressor capacity control that only uses discrete steps of compression or compressor on-off cycling. This type of control uses more than one stage and is not proportional control.

3.24 *Standard Air*. Air weighing 1.20 kg/m³ which approximates dry air at 21.1 °C and at a barometric pressure of 101.3 kPa.

3.25 *Supplementary Heat*. All heat required to increase the dry bulb temperature of dehumidified or heat pump heated Supply Air (as applicable) to 21 °C per Section 6.3 that is not provided by the following sources: a. the vapor compression cycle, b. a system that transfers heat from one part of the unit to the other (e.g., wrap-around heat pipe, wrap-around vapor compression cycle), c. a system that transfers heat from the Outdoor Air to the Supply Air. Supplementary Heat is expressed in units of W.

3.26 *Total Cooling Capacity*. The capacity associated with the change in air enthalpy, which includes latent cooling, sensible cooling and any effects of a VERS, W.

3.27 *Total Heating Capacity*. Amount of heat the DX-DOAS Unit can input to the Supply Air in the heating mode. This includes the heat only from the vapor compression cycle, supply air fan heat, and the VERS, W.

3.27.1 *Total Heating Capacity - DOAS*. The Total Heating Capacity of the DX-DOAS Unit limited to a maximum supply air temperature of 24 °C if the unit capacity produces a Supply Air dry bulb temperature greater than 24 °C.

3.28 *Ventilation Energy Recovery System (VERS)*. A system that preconditions Outdoor Air entering the DX-DOAS Unit through direct or indirect thermal and/or moisture exchange with the Exhaust Air. Figures showing suggested DX-DOAS with VERS laboratory schematics include Figures E3, E4, E5, and E6. Figures showing a DX-DOAS without VERS laboratory schematics include Figures E1 and E2.

3.28.1 *Test Option 1*. DX-DOAS unit with VERS where the Outdoor Air and Return Air conditions during the test are the same as the Standard Rating Conditions specified in Tables 4 and 5 of this standard. This option will have a VERS attached and operating. Suggested lab schematics for Option 1 can be found in Appendix E, specifically Figures E3, E4, and E5.

3.28.2 *Test Option 2*. DX-DOAS unit with VERS with Simulated Ventilation Air, adjusted to account for VERS pre-conditioning performance based on AHRI Standard 1061 (SI) ratings, entering the Outdoor Air inlet and Return Air inlet of the conditioning unit. This option will have a VERS attached and operating per Section C4. Suggested lab schematics for Option 2 testing can be found in Appendix E, specifically Figure E6.

3.29 *Water Source Heat Pump*. A heat pump that uses fluid circulated in a common piping loop as a heat source/heat sink. The temperature of the piping loop fluid is usually mechanically controlled within a moderate temperature range of 16.0 °C to 32.0 °C.

Section 4. Classifications

4.1 *Classification*. DX-DOAS Units within the scope of this standard shall be classified as shown in Table 1.

Table 1. Classification of DX-Dedicated Outdoor Air System Units									
Designation	AHRI Type ^{1,2,3}	Typical Arrangement							
Remote Condenser with Cycle Reheat	RC-A-R RC-B-R RC-W-R RC-H-R	<table border="1"> <tr><td>EVAP</td></tr> <tr><td>CYCLE REHEAT</td></tr> <tr><td>FAN</td></tr> <tr><td>HEAT</td></tr> </table> <table border="1"> <tr><td>COND</td></tr> <tr><td>COMP</td></tr> </table>	EVAP	CYCLE REHEAT	FAN	HEAT	COND	COMP	
EVAP									
CYCLE REHEAT									
FAN									
HEAT									
COND									
COMP									
Remote Condenser with VERS and Cycle Reheat	RC-A-P-R RC-B-P-R RC-W-P-R RC-H-P-R	<table border="1"> <tr><td>VERS</td></tr> <tr><td>CYCLE REHEAT</td></tr> <tr><td>FAN</td></tr> <tr><td>HEAT</td></tr> <tr><td>EVAP</td></tr> </table> <table border="1"> <tr><td>COMP</td></tr> <tr><td>COND</td></tr> </table>	VERS	CYCLE REHEAT	FAN	HEAT	EVAP	COMP	COND
VERS									
CYCLE REHEAT									
FAN									
HEAT									
EVAP									
COMP									
COND									
Single Package with Cycle Reheat	SP-A-R SP-B-R SP-W-R SP-H-R	<table border="1"> <tr><td>EVAP</td></tr> <tr><td>CYCLE REHEAT</td></tr> <tr><td>FAN</td></tr> <tr><td>HEAT</td></tr> <tr><td>COMP</td></tr> <tr><td>COND</td></tr> </table>	EVAP	CYCLE REHEAT	FAN	HEAT	COMP	COND	
EVAP									
CYCLE REHEAT									
FAN									
HEAT									
COMP									
COND									
Single Package with VERS and Cycle Reheat	SP-A-P-R SP-B-P-R SP-W-P-R SP-H-P-R	<table border="1"> <tr><td>VERS</td></tr> <tr><td>EVAP</td></tr> <tr><td>CYCLE REHEAT</td></tr> <tr><td>FAN</td></tr> <tr><td>HEAT</td></tr> <tr><td>COMP</td></tr> <tr><td>COND</td></tr> </table>	VERS	EVAP	CYCLE REHEAT	FAN	HEAT	COMP	COND
VERS									
EVAP									
CYCLE REHEAT									
FAN									
HEAT									
COMP									
COND									
<p>Notes:</p> <ol style="list-style-type: none"> 1. “-A” indicates air-cooled condenser, “-B” indicates air-cooled heat pump condenser”, “-H” indicates Ground Source Closed-loop Heat Pump, Ground Source Heat Pump or Water Source Heat Pump, and “-W” indicates water-source or water-cooled condenser. 2. “-A,” “-B,” “-H,” and “-W” are referenced in Tables 4 and 5. 3. “-P” indicates energy recovery pre-conditioning and “-R” indicates Reheat. These are applicable to “-A”, “-B,” “-H,” or “-W.” 									

Section 5. Test Requirements

5.1 Test Requirements. All Standard Ratings shall be verified by tests conducted in accordance with the test methods and procedures as described in this standard and its appendices. Units shall be tested in accordance with ANSI/ASHRAE Standard 198 as amended by this standard and Appendix C.

5.2 Equipment Installation. Units shall be installed per MII. In the event of conflicting instructions regarding the set-up of the unit under test, priority shall be given to MII that appear on the unit’s label over MII that are shipped with the unit. If the unit is a split system and the components’ MII conflict, priority shall be given to the indoor unit MII over the outdoor unit MII unless indicated otherwise by the STI.

5.3 Steady State Requirements and Measurement Intervals. Requirements for achieving equilibrium prior to testing (including when setting of airflow under Standard Rating Condition A), test duration, and recording of measurements shall be as described in Sections 8.2 and 8.4 of ANSI/ASHRAE Standard 198. Equilibrium, which means achievement of steady-state conditions meeting the tolerances of Section 6.6 of this standard, shall also be maintained during recording of measurements.

5.3.1 At least three consecutive sets of measurements made every five minutes shall be recorded to confirm the setting of airflow in Section 6.1.5. The measurements shall be made during steady operation meeting the applicable tolerances of Section 6.6 of this standard. When setting airflow under Standard Rating Condition A as described in Section 6.1.5.3, the equilibrium and measurement recording requirements described in the above paragraph shall be met.

5.4 Testing Requirements for DX-DOAS Equipped with VERS.

5.4.1 VERS Standard Rating Options. DX-DOAS equipped with VERS, can be tested using either one of the options described under Section 5.4.1.1 or Section 5.4.1.2.

5.4.1.1 Option 1. The Outdoor Ventilation Air and Return Air conditions are the same as the Standard Rating Conditions specified in Tables 4 and 5 of this standard.

5.4.1.2 Option 2. The Simulated Ventilation Airflow temperature and humidity shall be adjusted to account for VERS conditioning per Appendix C, Section C4. Option 2 shall not be used for Relief-air-cooled DX-DOAS.

5.4.2 Energy Recovery Wheel Rotational Speed. For DX-DOAS models with energy recovery wheels, if the DX-DOAS manufacturer uses an energy recovery wheel rotational speed different from the speed used to determine the EATR and effectiveness values, the default EATR and effectiveness values provided in Section C4 and Table C4 of Appendix C shall be used to determine performance.

5.4.3 Deactivation of VERS. If the VERS is capable of being deactivated and if the VERS deactivation is also specified by the manufacturer, the operation of the VERS may be deactivated for Standard Rating Condition C or D. This is allowed for testing either using Option 1 (Section 5.4.1.1) or Option 2 (Section 5.4.1.2). The air surrounding the unit and entering the Outdoor Coil for both Option 1 and 2 shall be equal to the Outdoor Air conditions specified in Tables 4 and 5 of this standard, except as outlined in Sections C2.1 and C2.1.2 of Appendix C.

Informative Note: Although other methods of deactivation can exist, the following examples are three common methods for VERS deactivation: a) the rotation of an energy recovery wheel can be stopped. b) Controlled shut off valves can be added to a heat pipe to prevent energy transfer between Outdoor Air and Return Air. c) Bypass dampers can allow most air to bypass any energy recovery device.

5.4.3.1 When using Option 1, if the deactivation is achieved by switching the position of face/bypass dampers, airflow shall first be reset for the bypass mode and airflow shall be reset as described in Section 6.1.5.5 using dry bulb air conditions of Standard Rating Condition D. If airflows had initially been set using the procedures of Section 6.1.5.3, match within required tolerances of Table 10.

5.4.3.2 When using Option 2, deactivation shall be simulated by substituting Outdoor Air conditions for Simulated Ventilation Air conditions and de-energizing VERS powered components (e.g. Energy Recovery Wheel rotation motors) as they would be during deactivation in field operation. If specified by the manufacturer, the position of the face/bypass dampers shall be switched and the airflow shall be reset as specified in Section 6.1.5.5 using dry bulb air conditions of Standard Rating Condition D.

5.5 Defrost Controls for Air-Source Heat Pump during Heating Mode. Defrost controls shall be left at manufacturer's factory settings if the published installation instructions provided with the equipment do not specify otherwise. Any defrost control settings specified by the manufacturer in installation instructions and that can be achieved through methods outlined in the MII may be used to achieve steady state. To facilitate testing, the manufacturer shall provide information and any necessary hardware to manually initiate a defrost cycle. If the defrost settings require defrost during the heating mode tests, the manufacturer shall submit a petition for a waiver from test procedure to obtain an alternative method of test, pursuant to 10 CFR §431.401. The Standard Rating F condition test is optional. If the Standard Rating F condition test is not conducted, a default value of 1.0 shall be assigned for COP_{DOAS,F}, in order to complete the ISCOP2 calculation.

5.6 Break-in. Manufacturers may optionally specify a “break-in” period to operate the equipment under test prior to conducting the test. If an initial break-in period is required to achieve performance, the break-in conditions and duration shall be specified by the manufacturer, but shall not exceed 20 hours in length. No testing per Section 6 shall commence until the manufacturer-specified break-in period is completed. Each compressor of the unit shall undergo this “break-in” period.

5.7 Condenser Head Pressure Controls. If modulation or cycling of air-cooled condenser fan(s) or water-cooled flow control valve(s) occurs that prevents the DX-DOAS unit from maintaining the test tolerances shown in Table 9, the STI document provided by the manufacturer shall be referenced to determine the settings required to stabilize the operation. The STI shall result in condensing (liquid outlet) pressure corresponding to a bubble point temperature between 24 °C and 54 °C. Should no STI documentation be provided, the operation without intervention should first be observed. For the test, the fan(s) or valve(s) causing the instability shall be set manually at a speed, operating state (on/off) or position to achieve stable condensing (liquid outlet) pressure corresponding to a bubble point temperature as close to 29 °C as possible while remaining no lower than 29 °C. If there is a discharge pressure port but no liquid pressure port, the STI settings or manual intervention shall achieve a stable discharge pressure corresponding to a bubble point temperature at least 1.7 °C higher than the minimum values indicated above.

5.8 Refrigerant Charging. All test samples shall be charged at Standard Rating Condition A (or condition at which the manufacturer indicates in the MII) in accordance with the MII. If the MII contain two sets of refrigerant charging criteria, one for field installation and one for lab testing, use the field installation criteria. Unless the MII specifies a tighter charging tolerance, the test condition tolerances specified in Table 2 shall be used for the criterion specified by the MII.

5.8.1 If the MII give a specified range for superheat, sub-cooling, or refrigerant pressure, the average of the range shall be used to determine the refrigerant charge. Perform charging of near-azeotropic and zeotropic refrigerants only with refrigerant in the liquid state.

5.8.2 If there are no MII and/or the MII do not provide parameters and specified values, set superheat to a value of -11 °C for fixed orifice systems or set sub-cooling to a value of -12 °C for expansion valve systems, with test condition tolerance as specified in Table 2.

5.8.3 In the event of conflicting information between charging instructions, use the instruction priority order indicated in Section 5.2. Conflicting information is defined as multiple conditions given for charge adjustment where all conditions specified cannot be met. If such instances of conflicting information occur within the highest ranking set of instructions for which refrigerant charging instructions are provided, follow the hierarchy in Table 2 for priority.

Table 2. Charging Hierarchy and Charging Test Condition Tolerance					
Fixed Orifice			Expansion Valve		
Priority	Method	Tolerance	Priority	Method	Tolerance
1	Super-heat	± 1.1 °C	1	Sub-cooling	± 1.1 °C
2	High Side Pressure or Saturation Temperature	± 28.0 kPa or ± 0.6 °C	2	High Side Pressure or Saturation Temperature	± 28.0 kPa or ± 0.6 °C
3	Low Side Pressure or Saturation Temperature	± 28.0 kPa or ± 0.6 °C	3	Low Side Pressure or Saturation Temperature	± 14.0 kPa or ± 0.4 °C
4	Low Side Temperature	± 1.1 °C	4	Approach Temperature	± 0.6 °C
5	High Side Temperature	± 1.1 °C	5	Charge Weight	± 57.0 g
6	Charge Weight	± 57.0 g			

5.8.4 Single Package Unit. Install one or more refrigerant line pressure gauges during the setup of the unit, as described in Section 5.8.4.1 or 5.8.4.2, located depending on the parameters used to verify or set charge, unless the MII instructions say not to verify refrigerant charge.

5.8.4.1 Install a pressure gauge at the location of the service valve on the liquid line if charging is on the basis of sub-cooling, high side pressure, corresponding saturation, or dew point temperature.

5.8.4.2 Install a pressure gauge at the location of the service valve on the suction line if charging is on the basis of superheat, high side pressure, corresponding saturation, or dew point temperature

5.8.5 The refrigerant charge obtained as described in Section 5.8 shall then be used to conduct all tests used to

determine performance. All tests shall run until completion without further modification. If measurements indicate that refrigerant charge has leaked during the test, repair the refrigerant leak, repeat any necessary set-up steps, and repeat all tests.

5.9 *Test Unit Location.* Install the unit under test in accordance with Sections 6.1, 6.6 and 7.2 of ANSI/ASHRAE Standard 198 (with modifications outlined in Appendix C of this standard).

5.10 *Atmospheric Pressure.* Tests shall be conducted at an atmospheric pressure of at least 94.5 kPa.

5.11 *Supplementary Heat.* All Supplementary Heat sources, including electric resistance heat, shall be turned off or disconnected from power during the test.

5.12 *Instrumentation and Apparatus.* Use instruments and apparatus that meet the applicable requirements specifications in the following standards (see Sections 5.12.1 through 5.12.10).

5.12.1 *Airflow Measurement.* Sections 5.3, 6.2, 6.3, and 7.7 (not including Sections 7.7.1.2, 7.7.3, and 7.7.4) of ANSI/ASHRAE Standard 37.

5.12.2 *Refrigerant and Liquid Pressure Measurement.* Section 5.2 of ANSI/ASHRAE Standard 37.

5.12.3 *Duct Static Pressure and Pressure Difference.* Sections 5.1.3, 5.3.2, 6.4, and 6.5 of ANSI/ASHRAE Standard 37.

5.12.4 *Temperature Measurements.* Temperature measurements other than those used to determine air conditions (dry bulb temperature and water vapor content), shall follow Section 4.4 of ANSI/ASHRAE Standard 198. For air condition measurements, see Section C3 of Appendix C.

5.12.5 *Electrical Measurements.* Section 4.5 of ANSI/ASHRAE Standard 198.

5.12.5.1 Modulating compressors require an integrated measurement or an indicated reading of no more than one second.

5.12.6 *Liquid Flow Measurement.* Section 4.6 of ANSI/ASHRAE Standard 198.

5.12.7 *Time and Mass Measurements.* Section 4.7 of ANSI/ASHRAE Standard 198.

5.12.8 *Test Room and Room Conditioning System Requirements.* Section 7.1 of ANSI/ASHRAE Standard 198.

5.12.9 *Volatile Refrigerant Flow Measurement.* Section 5.5 of ANSI/ASHRAE Standard 37.

5.12.10 *Atmospheric pressure measurement.* See Section 5.2 of ANSI/ASHRAE Standard 37, except the atmospheric pressure measuring instruments shall be accurate to within $\pm 0.5\%$ of the reading.

5.13 *Electrical Conditions.* Standard Rating tests shall be performed at the nameplate rated voltage and frequency unless otherwise specified in this standard.

5.13.1 For equipment that is rated with 208-230V dual nameplate voltages, Standard Rating tests shall be performed at 230V. For all other dual nameplate voltage equipment covered by this standard, the Standard Rating tests shall be performed at both voltages or at the lower of the two voltages if only a single Standard Rating is to be published.

Section 6. Rating Requirements

6.1 *Standard Ratings.* Standard Ratings shall be at the Standard Rating Conditions specified in Tables 4 and 5 and in this Section.

6.1.1 All Standard Ratings shall be determined by tests in accordance with Section 5.

6.1.2 Ratings shall include the following performance metrics.

6.1.2.1 *COP_{DOAS} (heat pump only)*. COP_{DOAS} shall be expressed in terms of W/W and stated to the nearest 0.05 W/W.

6.1.2.2 *Electrical Power Input*. Electrical power input shall be expressed in terms of W and stated to the nearest 100 W.

6.1.2.3 *ISCOP2 (heat pump only)*. ISCOP2 shall be expressed in terms of W/W and stated to the nearest 0.1 W/W.

6.1.2.4 *ISMRE2*. ISMRE2 shall be expressed in terms of kg/kW·h and stated to the nearest 0.05 kg/kW·h.

6.1.2.5 *MRC*. MRC shall be expressed in terms of kg/h and stated to the nearest multiple, as shown in Table 3.

Table 3. Multiples for Rated MRC	
Rated MRC For Units (kg/h)	Multiples (kg/hr)
$0 < \text{MRC} \leq 14$	0.1
$14 < \text{MRC} \leq 27$	0.2
$27 < \text{MRC} \leq 82$	0.5
$82 < \text{MRC}$	1

6.1.2.6 *MRE*. MRE shall be expressed in terms of kg/kW·h and stated to the nearest 0.05 kg/kW·h.

6.1.2.7 *Total Heating Capacity (heat pump only)*. Total heating capacity shall be expressed in terms of W and stated to the nearest 25 W.

6.1.2.8 *Supply Air Temperature and Dew Point*. Supply Air dry bulb, wet bulb and dew point (dew point is only required in the dehumidification mode of operation) shall be expressed in terms of °C and stated to the nearest 0.1°C.

Table 4. Conditions for Standard Rating and Maximum Operating Tests for Classifications A, B, and W DX-DOAS Units¹

Rating Condition		Outdoor Air (OA) Temperature, °C		Condenser Water Entering Temperature, Cooling Tower Water, °C ²	Condenser Water Entering Temperature, Chilled Water, °C ^{2,3}	Ambient Air Temperature ² , °C
		Dry bulb	Wet bulb			
DEHUMIDIFICATION	Standard Rating A Conditions ⁵	35.0	26.0	30.0	7.0	35.0
	Standard Rating B Conditions ⁵	27.0	23.0	27.0	7.0	27.0
	Standard Rating C Conditions ⁵	21.0	19.0	23.0	7.0	21.0
	Standard Rating D Conditions ⁵	17.0	15.0	19.0	7.0	17.0
	Maximum Operating Conditions	46.0	24.0	32.0	N/A	46.0
HEATING	Part Load Standard Rating E Conditions ^{6,7}	8.0	6.0	N/A	N/A	8.0
	Standard Rating F Conditions ^{6,7,8}	-8.0	-9.0	N/A	N/A	-8.0
	Maximum Operating Conditions	21.0	N/A	N/A	N/A	21.0

Notes:

1. Supplementary Heat is not tested under this standard.
2. See Section 6.1.6.5 for test liquid requirements.
3. Informative note: While many configurations of a chilled water-cooled condenser may exist, typically this system would apply when a water-cooled DX-DOAS unit is connected to a chilled water loop to provide lower dew point air than would be possible with that chilled water and a water coil, the “Condenser Water Entering Temperature, Chilled Water” temperature condition may be used to provide the heat rejection capability for a DX-DOAS unit
4. Conditions surrounding the unit and entering the condenser (outdoor) coil are the same as the Outdoor Air entering conditions, except as described in Section C2.1.2 of Appendix C.
5. Return Air for Standard Rating Conditions A, B, C and D shall be 23.9 °C dry bulb temperature and 16.9 °C wet bulb temperature, except as described in Section C4 of Appendix C.
6. Return Air for Standard Rating Conditions E and F shall be 21.1 °C dry bulb temperature, except as described in Section C4 of Appendix C.
7. For Standard Rating Conditions E and F, Return Air wet bulb conditions of 14.7 °C is required for Relief Air-Cooled DX-DOAS. Otherwise, control of Return Air water vapor content is not required for Standard Rating Conditions E and F.
8. Standard Rating F Condition test is optional. If Standard Rating F Condition test is not conducted, a default value of 1 shall be assigned for COP_{DOAS,F}.

Table 5. Conditions for Standard Rating and Maximum Operation Tests for Classification H DX-DOAS Units¹

Rating Condition		Outdoor Airflow (OA) Temperature ² , °C		Inlet Fluid Temperature, °C	
		Dry bulb	Wet bulb	Water-Source Heat Pumps ³	Water-Source Heat Pump, Ground-Source Closed Loop (Optional) ^{3,4}
DEHUMIDIFICATION	Standard Rating A Conditions ⁵	35.0	26.0	30.0	25.0
	Standard Rating B Conditions ⁵	27.0	23.0	27.0	25.0
	Standard Rating C Conditions ⁵	21.0	19.0	23.0	20.0
	Standard Rating D Conditions ⁵	17.0	15.0	19.0	20.0
	Maximum Operating Conditions	46.0	24.0	40.0	40.0
HEATING	Part Load Standard Rating E Conditions ^{6,7}	8.0	6.0	20.0	5.0
	Standard Rating F Conditions ^{6,7,8}	-8.0	-9.0	20.0	0.0
	Maximum Operating Conditions	21.0	N/A	30.0	25.0

Notes:

1. Supplementary Heat is not tested under this standard.
2. Conditions surrounding the unit are the same as the Outdoor Air entering conditions.
3. See Section 6.1.6.5 for test liquid requirements.
4. Manufacturer may recommend antifreeze type and concentration at the optional conditions.
5. Return Air for Standard Rating Conditions A, B, C and D shall be 24.0 °C dry bulb temperature and 17.0 °C wet bulb temperature dry bulb temperature, except as described in Section C4 of Appendix C.
6. Return Air for Standard Rating Conditions E and F shall be 21.0 °C dry bulb temperature, except as described in Section C4 of appendix C.
7. Control of return air water vapor content is not required for Standard Rating Conditions E and F.
8. Standard Rating F Condition test is optional. If Standard Rating F Condition test is not conducted, a default value of 1 shall be assigned for COP_{DOAS,F}.

6.1.3 Supply Air Dew Point Temperature. After establishing Standard Airflow per Section 6.1.5, Supply Air dew point temperature in °C shall be $12.8 + 0.186 \times (101.3 - P_{\text{bar}})$ or below for all Standard Rating Conditions A through D where barometric pressure P_{bar} is measured in kPa. Supply Air dew point temperature for tests conducted for Standard Rating Conditions B, C, and D shall be within ± 0.2 °C of the average Supply Air dew point temperature measured for Standard Rating Condition A. If the Supply Air dew point temperature cannot be controlled within ± 0.2 °C for a given unloading point (e.g. because the unit has Staged Capacity Control), but tests can be conducted for which the Supply Air

dew point temperatures are above and below the target, steady state tests shall be conducted above and below the target. If the lowest capacity stage results in a dew point temperature lower than the target, either (a) conduct two tests, the first using the lowest-capacity stage, and the second with compressors turned off, or (b) conduct one test for which the power input and electric energy use of the compressor and the condenser fans are separately measured. (Refer to Section 6.9 of this standard for MRE calculations) There are no Supply Air dew point temperature requirements for heating mode tests.

6.1.3.1 Initial Standard Rating Condition A Dehumidification Test. For Standard Rating Condition A, operate the unit within a test condition tolerance of ± 0.2 °C of the dew point that would result in matching the certified Moisture Removal Capacity (reported per Section 6.1.2.5) to the certified supply airflow at the measured barometric pressure. If there is no rated airflow, use the full capacity settings and follow the provisions in Section 6.1.5.3 for setting airflow.

6.1.4 Supply Air Dry Bulb Temperature.

6.1.4.1 ISMRE₂₇₀/MRE₇₀. Attempt to set the Supply Air dry bulb temperature within a temperature range of 21 °C to 24 °C for all Standard Rating Conditions used to calculate MRE₇₀ or ISMRE₂₇₀. If Cycle Reheat cannot be adjusted in sufficiently small increments to obtain Supply Air dry bulb temperature (adjusted for duct losses) in the range from 21 °C to 24 °C for dehumidification tests or does not attain 21 °C at its maximum reheat setting, adjust it to provide the maximum achievable temperature lower than this target range. If Cycle Reheat overshoots 24 °C at its minimum reheat setting, test using the minimum setting. The supplemental heating penalty and the supplemental cooling penalty apply to this rating, as described in Sections 6.3 and 6.4.

6.1.4.2 ISMRE₂/MRE. Supply Air dry bulb temperatures shall be set using the STI, and should be below 24 °C (adjusted for duct losses) . If an approach for setting the Supply Air dry bulb temperatures is not indicated in the STI and Supply Air Temperatures are not otherwise reported, the temperature shall be set following Section 6.1.4.1. If Cycle Reheat overshoots 24 °C at its minimum reheat setting, test using the minimum setting. The supplemental cooling penalty applies to this rating, as described in Sections 6.4.

6.1.4.3 Heating Mode Tests. For heat pump units in heating mode, attempt to set the Supply Air dry bulb temperature within a temperature range of 21 °C to 24 °C. If the Supply Air dry bulb temperature (adjusted for duct losses) cannot be controlled within this target range for a given Standard Rating condition (e.g. because the unit has Staged Capacity Control), two steady state tests shall be conducted above and below the target range (i.e., Supply Air dry bulb temperature is above 24 °C for one test and below 21 °C for the other). For a DX-DOAS without VERS, the lower of these capacity stages must include some non-zero level of compressor operation—for a DX-DOAS with VERS, the lower of these stages may include operation of the VERS without compressor operation. If the lowest compressor capacity stage of a DX-DOAS unit without VERS delivers Supply Air dry bulb temperature greater than 24 °C, test the unit at this lowest compressor capacity stage. If a DX-DOAS unit with VERS delivers a Supply Air dry bulb temperature greater than 24 °C without operating the compressor, test the unit without operating the compressor

6.1.4.4 Duct Losses. The Supply Air dry bulb temperature shall be adjusted for duct losses for ductwork between the unit’s supply duct connection and the air condition measurement location using Equations 1 and 2 prior to comparison with the target. Use the adjusted value wherever T_{SA} is called for in ANSI/ASHRAE Standard 198 and in this test standard.

Note: If the Supply Air duct passes through a chamber dividing wall, separately calculate and add duct loss q_{loss} for the duct exposed to different chamber temperatures

$$T_{SA} = T_{SA,measured} + \frac{q_{loss}}{Q_{SA} \cdot c_{pSA}} \tag{1}$$

$$q_{loss} = U \cdot A_{duct} (T_{SA,measured} - T_{OA}) \tag{2}$$

6.1.5 Supply and Return Airflow Rates. Standard ratings shall be determined after setting up Supply Airflow (and Return Airflow rate for units with VERS or Relief-Air-Cooling) as specified in this section.

6.1.5.1 Representation of Airflow.

6.1.5.1.1 Airflow specifications and measured airflow to be compared to specifications shall be expressed in m³/s, calculated as shown in Equation 3.

$$Q_{SA} = \frac{Q_{mSA}}{1.20 \cdot v_{SA}} = \frac{Q_{mSA}}{1.20 \cdot v_{SA}(1+W_{SA})} \quad 3$$

Where, 1.20 kg/m³ is the density of air at 20°C and 101.3 kPa.

6.1.5.1.2 Rated Supply Airflow rate shall be rounded as indicated in Table 6.

Rated Airflow for Units, m ³ /s	Multiples, m ³ /s
< 0.12	0.005
≥ 0.12 and < 0.24	0.01
≥ 0.24 and < 0.47	0.02
≥ 0.47	0.05

6.1.5.2 If there is no Supply Airflow specification, refer to Section 6.1.5.3 for unspecified Supply Airflow. Otherwise, set up Airflow as indicated below. If the STI includes equipment settings for Airflow, start with those settings. Otherwise, make no unit adjustments. Control the test chamber(s) at Point C dry bulb conditions per Table 4 and Table 5. When building a plenum to duct outdoor air to an air intake hood, consider the requirements of Section C2.5.1 when setting airflows. The unit’s compressors shall be off but optional VERS shall be active. Adjust the unit and the airflow measurement apparatus fans to obtain the Table 7 ESP levels corresponding to the specified Supply Airflow, a measured Supply Airflow within a +/- 3% test condition tolerance of its specified value, and a measured Return Airflow (for units with VERS or Relief-Air-Cooling) within +/- 3% test condition tolerance of the measured Supply Airflow. If successful, preliminary airflows are established—refer to Section 6.1.5.4. If not, make adjustments as described in Sections 6.1.5.2.1-5.

6.1.5.2.1 For belt-drive fans without variable motor speed control (e.g. a variable-frequency drive) or belt-drive fans with variable motor speed control already at maximum or minimum settings, change sheaves using compatible off-the-shelf sheaves and re-start the above adjustment procedure.

6.1.5.2.2 For direct-drive fans with step-adjustable motor speed control at an intermediate speed setting (not the maximum or minimum speed), change to the next higher or lower speed setting as appropriate and re-start the above set-up procedure. If, for two adjacent speed steps for such a fan, the lower speed is too low and the higher speed is too high, use the higher speed. Set the airflow measurement apparatus fans to obtain a measured Supply Airflow within a +/- 3% test condition tolerance of its specified value, and a measured Return Airflow (for units with VERS or Relief-Air-Cooling) within +/- 3% test condition tolerance of the measured Supply Airflow.

6.1.5.2.3 If a fan’s maximum speed is too low to satisfy the Airflow and ESP requirements within tolerance (i.e. the motor speed is at the highest setting, a larger compatible off-the-shelf sheave is not available, or increased speed would overload the motor or motor drive) and the motor is not a non-standard low-static motor, use the maximum speed and adjust the airflow measurement apparatus fan to achieve an airflow and ESP satisfying Table 7.

6.1.5.2.4 If the motor is a non-standard low-static motor, use the maximum available speed that does not overload the motor or motor drive and adjust the airflow measurement apparatus fan to achieve the specified Supply Airflow within +/-3% test condition tolerance (for Supply Air fans) or to set the Return Airflow within +/- 3% test condition tolerance of the measured Supply Airflow.

6.1.5.2.5 If a fan’s minimum speed is too high to satisfy the Airflow and ESP requirements within tolerance (i.e. the motor speed is at the lowest setting, or a smaller compatible off-the-shelf sheave is not available), use the minimum speed setting and adjust the airflow measurement apparatus fan to achieve the specified Supply Airflow within +/-3% test condition tolerance (for Supply Air fans) or to

set the Return Airflow within +/- 3% test condition tolerance of the measured Supply Airflow.

6.1.5.3 *Unspecified Supply Airflow.* If Supply Airflow is not specified then it must be determined by testing at Condition A and adjusting Supply Airflow such that the Supply Air dew point temperature is $12.8 + 0.186 \times (101.3 - P_{\text{bar}})$ within a test condition tolerance of $-0.3/+0.0$ °C. Set up Airflow as described in Section 6.1.5.2, except that achieving a Supply Airflow within +/- 3 % of the specified Supply Airflow shall be replaced with achieving the above Supply Air dew point requirement. Return Airflow shall still be set within +/- 3 % of measured Supply Airflow. After setting airflow, do not make any further adjustments of the supply fan, return fan or airflow measurement apparatus fan (except as indicated for optional VERS bypass for Standard Rating Condition D described in Section 6.1.5.5), and proceed with performance testing without rechecking the Supply dew point temperature as described in Section 6.1.5.4.

6.1.5.4 *Confirmation of Sufficient Dehumidification for Preliminary Airflows.* Operate the unit at Standard Rating Condition A. If Supply Air dew point temperature is less than or equal to $12.8 + 0.186 \times (101.3 - P_{\text{bar}})$ then Airflow settings are confirmed. Do not make any further adjustments of the supply fan, return fan or airflow measurement apparatus fan (except as indicated for optional VERS bypass for Standard Rating Condition D described in Section 6.1.5.7), and proceed with performance testing. If the Supply Air dew point temperature is high, reset Airflow(s) as described in Section 6.1.5.3.

6.1.5.5 *Airflow for VERS Bypass.* If VERS bypass is specified in the STI for Standard Rating Condition D, reset Airflows prior to conducting performance testing for this condition. Open the VERS bypass and deactivate the VERS. If there was no Supply Airflow specification, use the Supply Airflow measured for Standard Rating Condition A as the specified Supply Airflow. Follow the steps in Section 6.1.5.2 to set Airflows. When complete, proceed with performance testing for Standard Rating Condition D.

6.1.5.6 *External Static Pressure.* When setting airflow in accordance with Section 6.1.5.2 or 6.1.5.3, the minimum external static pressures shall be as specified in Table 7 or the certified external static pressure, whichever is greater. All pressures shall be expressed in Pa.

Table 7. External Static Pressures		
Supply Airflow Rate, m ³ /h	Minimum Supply Airflow External Static Pressure, Pa	Minimum Return Airflow External Static Pressure, Pa
≤ 1500	159	187
> 1,500 and ≤ 2,400	214	212
> 2,400 and ≤ 3,900	241	231
> 3,900 and ≤ 6,000	266	251
> 6,000 and ≤ 7,600	286	266
> 7,600 and ≤ 11,900	309	281
> 11,900 and ≤ 15,800	328	296
> 15,800	336	304

6.1.6 *Liquid Flow Rates for Water-Cooled, Water-Source Heat Pump, and Ground-Source Heat Pump.*

6.1.6.1 For DX-DOAS Units with or without integral liquid pumps, ratings shall be determined at a liquid flow rate specified by the manufacturer. The liquid flow rate specified by the manufacturer for Standard Rating Conditions and Max Operating Conditions shall result in a liquid temperature rise greater than or equal to 4 °C at Standard Rating Condition A. Manufacturers may specify a liquid flow rate for Manufacturer Application Conditions that results in a liquid temperature change greater than or equal to 2 °C.

6.1.6.2 A single liquid flow rate shall be used for all of the tests required in this part of the standard unless automatic adjustment of the liquid flow rate is provided by the equipment. A separate control signal output for each step of liquid flow rate will be considered as an automatic adjustment. In no case shall the liquid flow rate for any of the other Standard Rating condition tests (i.e., B, C, and D) exceed the value as determined as described in Section 6.1.5.1.

6.1.6.3 *Values of Water Flow and Water Pressure Drop Ratings.* Water flow rate and water pressure drop values shall be determined at each Standard Rating Condition specified in Tables 4 and 5. Water flow rate shall be expressed in terms of L/s and stated to the nearest 0.01 L/s. Water pressure drop through the unit for the rated standard flow rate(s) shall be expressed in multiples of 1 kPa.

6.1.6.4 *Values of Water Pump Effect.* In calculating MRE and COP, an addition for the water pump effect, $P_{E,x}$, applicable for Standard Rating Condition x (see Sections 6.9 and 6.11), shall be added to the measured power input, which is represented as P_T in ANSI/ASHARE 198 (including total power input to the compressor(s), fan(s), controls and other items included as part of the model number) and determined using Equation 4. Table 8 shall apply to all water-cooled and water-source units.

$$P_{E,x} = WF [(PP_B \cdot \Delta P) + C] \tag{4}$$

Liquid Flow Rate (WF), L/s	Basic Pumping Penalty (PP _B), W/(L/s·kPa)
0.06 – 0.25	11.50
0.26 – 0.50	8.93
0.51 – 0.75	6.19
0.76 – 1.00	5.34
1.01 – 1.25	4.92
1.26 and above	4.65

6.1.6.5 *Test Liquid.* The test liquid for DX-DOAS Units shall be water, except for ground-source closed-loop DX-DOAS, which shall use a manufacturer-specified fluid (see note 7 of Table 5), and it shall be purged of all gas, as required in ISO Standard 13256-1 Section 4.1.9.3.

6.2 *Application Ratings.* Ratings at conditions other than those specified in Tables 4 and 5 may be published as Application Ratings, and shall be based on data determined by the methods prescribed in Section 6.1. Application Ratings shall not include integrated performance ratings (e.g. ISMRE2 and IS COP2).

6.3 *Supplementary Heat Penalty.* Calculate the Supplementary Heat penalty for the determination of MRE_{70} and $COP_{IS COP,x}$ (where x represents the Standard Rating Condition) when the Supply Air dry bulb temperature, adjusted as described in Section 6.1.4, is less than 21 °C.

6.3.1 When two dehumidification mode tests are conducted for a staged-capacity DX-DOAS for a single Standard Rating Condition, calculate and apply the heating penalty for each test prior to calculating the weighted average MRE_{70} values, per Section 6.9.1.

6.3.2 Calculate the Supplementary Heat penalty, **W HeatPenalty_x**, expressed in W, as described in Section C6 of this standard.

6.4 *Supplementary Cooling Penalty.* For dehumidification mode, calculate the supplementary cooling penalty for the determination of MRE_x and $MRE_{70,x}$ (where x represents the Standard Rating Condition) when the Supply Air dry bulb temperature, adjusted as described in Section 6.1.4, is greater than 24 °C.

6.4.1 When two dehumidification mode tests are conducted for a staged-capacity DX-DOAS for a single Standard Rating Condition, calculate and apply the supplementary cooling penalty for each test prior to calculating the weighted average MRE and MRE_{70} values.

6.4.2 Calculate the supplementary cooling penalty, **W CoolPenalty_x**, expressed in W, as described in Section C6 of this standard.

6.5 *Determination of EATR.*

6.5.1 For DX-DOAS units equipped with a VERS, where the VERS is not an Energy Recovery Wheel, $EATR_{DOAS}$ equals zero.

6.5.2 For DX-DOAS units equipped with an Energy Recovery Wheel, adjust the $EATR_{DOAS}$ to DX-DOAS Supply

Airflow rate conditions as described in Section C4 of this standard.

Note: If AHRI Standard 1061 (SI) information is not available, set $EATR_{DOAS}$ equal to 0.065.

6.6 Tolerances.

6.6.1 *Verification Testing.* Single sample production verification tests shall meet the requirements indicated in Appendix G.

6.6.2 *Test Measurement Tolerances.* Tolerances specified in this standard supersede tolerances specified in ANSI/ASHRAE Standard 198. Unless superseded by this standard, all other tolerances specified in Table 2a and 2b of ANSI/ASHRAE Standard 37 apply. Test Operating Tolerances and Condition Tolerances are specified in Table 9.

Measurement	Test Operating Tolerance	Test Condition Tolerance
Outdoor Coil air dry bulb temperature, °C: Entering Leaving	1.1 ⁸ 1.1 / 1.7 ^{1,3,8}	0.3 ⁸ -
Outdoor Coil air wet bulb temperature, °C: Entering Leaving	0.6 ^{2,8} 0.6 ^{3,8}	0.2 ^{2,8} -
Outdoor Ventilation Air, Return Air, and entering desiccant wheel Regeneration Air dry bulb temperature, °C	1.1	0.3
Outdoor Ventilation Air, Return Air, and entering desiccant wheel Regeneration Air wet bulb temperature, °C	0.6	0.2
Supply Air dry bulb temperature, °C	1.1 / 1.7 ¹	See target ranges in Section 6.1.2
Supply Air wet bulb temperature, °C	0.6	See dew point target ranges in Section 6.1.1
Water or water mixture serving refrigerant/water coil temperature, °C Entering Leaving	0.3 0.3 ⁴	0.1
Saturated refrigerant temperature corresponding to the measured indoor side pressure ⁵ , °C	1.7	0.3
Refrigerant liquid temperature ⁵ , °C	0.3	0.1
Supply and Return Air external static pressure, kPa	0.01	-0.0/+0.01 ^{6,7}
Airflow Nozzle Differential Pressure, % of reading	5.0	N/A
Electrical voltage, % of reading	2.0	1.0
Liquid flow rate, % of reading	2.0	-
Notes: 1. The test operating tolerance is 1.1°C °C for dehumidification tests and 1.7 °C for heating tests. 2. Applicable for heating tests of air-cooled units and only applicable for dehumidification tests when testing evaporatively-cooled equipment or equipment that used Conditioning Coil condensate to enhance Outdoor Coil cooling. 3. Applies only when using the Outdoor Air enthalpy method. 4. Applies only when using the outdoor liquid coil method. 5. Tolerance applies only for the compressor calibration and refrigerant enthalpy methods; the saturation temperature, in this case, shall be evaluated based on the pressure transducer located between the conditioning coil and the compressor for the given operating mode, heating or cooling. 6. Test condition tolerance for external static pressure applies only during the setting of airflows. 7. Deviation from the required test condition tolerance for external static pressure may be allowed as described in the airflow setting procedures of Section 6.1.5. 8. Excludes Relief-Air-Cooled DX-DOAS		

6.7 *Secondary Verification.* Secondary verification measurements of dehumidification and heat pump heating capacity are

described in Section C5 of this standard. The secondary measurements shall be recorded during the same time as the primary capacity test measurements. The dehumidification and heat pump heating capacity measurements from the primary and secondary tests shall match within $\pm 6\%$.

6.8 *Moisture Removal Capacity.*

6.8.1 For DX-DOAS Units equipped with VERS being tested under Option 1, or DX-DOAS Units not equipped with VERS, calculate the measured MRC as shown in Equation 5:

$$MRC = 3600 \cdot 1.20 \cdot Q_{SA}((W_{OA} - W_{SA}) - EATR_{DOAS} \cdot (W_{OA} - W_{RA})) \quad 5$$

Where:

3600 = conversion for seconds per hour

1.20 = density of Standard Air, kg/m³

6.8.2 For DX-DOAS equipped with VERS tested under Option 2 (except for Standard Rating Condition D for DX-DOAS Units equipped with VERS that are deactivated for this test condition), calculate the MRC as shown in Equations 6 and 7:

$$MRM = 3600 \cdot 1.20 \cdot Q_{SA}(W_{SV} - W_{SA}) \quad 6$$

$$MRC = MRM + 3600 \cdot 1.20 \cdot Q_{SA}((W_{OA} - W_{SV}) - EATR_{DOAS} \cdot (W_{OA} - W_{RA})) \quad 7$$

6.8.3 For DX-DOAS tested under Option 2 equipped with VERS that are deactivated for Standard Rating Condition D, calculate the Moisture Removal Capacity (MRC) for this test condition as shown in Equation 8:

$$MRC = 3600 \cdot 1.20 \cdot Q_{SA}(W_{OA} - W_{SA}) \quad 8$$

6.9 *Moisture Removal Efficiency Ratings.* For testing DX-DOAS units and heat pump DX-DOAS Units (1) at Standard Rating Condition A, and (2) when the measured Supply Air dew-point temperature meets the target Supply Air dew-point temperature within the specified test condition tolerance for a single test for Standard Rating Conditions B, C, or D, per Section 6.1.3, calculate MRE and MRE₇₀ for the Standard Rating Condition *x* (where *x* is A, B, C or D) using Equations 9 and 10. If points B, C, and D cannot be maintained within specified test condition tolerances, then follow the procedures in 6.8.1. To clarify, W HeatPenalty_{*x*} and W CoolPenalty_{*x*} cannot simultaneously be non-zero for a test.

$$MRE_{70,x} = \frac{1000 \cdot MRC_x}{(P_{T,x} + P_{E,x}) + W \text{ HeatPenalty}_x + W \text{ CoolPenalty}_x} \quad 9$$

$$MRE_x = \frac{1000 \cdot MRC_x}{(P_{T,x} + P_{E,x}) + W \text{ CoolPenalty}_x} \quad 10$$

6.9.1 *Weighted average method.* When the compressor capacity stages cannot be adjusted such that measured Supply Air dew-point temperature meets the target Supply Air dew-point temperature within the specified test condition tolerance for a single test for Standard Rating Conditions A, B, C, or D, but compressor capacity can be adjusted such that measured Supply Air dew-point temperature measurements for two tests at a given Standard Rating Condition *x*, where *x* could be A, B, C or D, bracket the target Supply Air dew-point temperature, use the following Weighted Average Method. (e.g. for testing units with staged compressors).

6.9.1.1 For the compressor capacity control stages that nearest bracket the target Point A Supply Air dew point, calculate averaging weights *a*_{1,*x*}, *a*_{2,*x*} for the two tests 1 and 2 conducted for Standard Rating Condition *x* (*x* could be A, B, C, or D) Using Equations 11 and 12. The calculation shall be made so that the calculated average Supply Air humidity ratio equals the Supply Air humidity ratio measured at Standard Rating Condition A, and that the sum of the weight is equal to 1.

$$a_{1,x} = \frac{W_{SA,A} - W_{SA,2}}{W_{SA,1} - W_{SA,2}} \quad 11$$

$$a_{2,x} = 1 - a_{1,x} \quad 12$$

6.9.1.2 Calculate the weighted average MRC for the given Standard Rating Condition as shown in Equation 13:

$$MRC_{avg,x} = a_{1,x} \cdot MRC_{1,x} + a_{2,x} \cdot MRC_{2,x} \quad 13$$

For calculating MRE, calculate the weighted average power input for the given Standard Rating Condition as shown in Equation 14:

$$P_{avg,x} = a_{1,x}(P_{T,1,x} + P_{E,x} + W \text{ CoolPenalty}_{1,x}) + a_{2,x}(P_{T,2,x} + P_{E,2,x} + W \text{ CoolPenalty}_{2,x}) \quad 14$$

For calculating MRE₇₀, calculate the weighted average power input for the given Standard Rating Condition as shown in Equation 15:

$$P_{70,avg,x} = a_{1,x}(P_{T,1,x} + P_{E,1,x} + W \text{ CoolPenalty}_{1,x} + W \text{ HeatPenalty}_{1,x}) + a_{2,x}(P_{T,2,x} + P_{E,2,x} + W \text{ CoolPenalty}_{2,x} + W \text{ HeatPenalty}_{2,x}) \quad 15$$

Calculate the MRE or MRE₇₀ using Equations 16 and 17:

$$MRE_x = \frac{MRC_{avg,x}}{P_{avg,x}} \quad 16$$

$$MRE_{70,x} = \frac{MRC_{avg,x}}{P_{70,avg,x}} \quad 17$$

6.9.2 Degradation Coefficient Method. When the Supply Air dew-point temperature measured when operating the unit at its lowest-capacity compressor stage is lower than the target Supply Air dew-point temperature in excess of the specified test condition tolerance, then the perform additional tests in accordance with 6.9.2.1 and 6.9.2.2. Adjust the MRE and MRE₇₀ by using a degradation coefficient, as show in Equations 18-27.

$$MRE_x = \frac{MRC_{Tgx}}{LF_x \cdot C_{D_x} \cdot (P_{CC_x} + W \text{ CoolPenalty}_x) + P_{NCx}} \quad 18$$

$$MRE_{70,x} = \frac{MRC_{Tgx}}{LF_x \cdot C_{D_x} \cdot (P_{CC_x} + W \text{ CoolPenalty}_x + W \text{ HeatPenalty}_x) + P_{NCx}} \quad 19$$

For DX-DOAS with VERS, with deactivated VERS (see Section 5.4.3), or with sensible-only VERS tested under Standard Rating Conditions other than D:

$$C_{D_x} = 1 + 0.35 \cdot (1 - LF_x) \quad 20$$

For DX-DOAS with total energy recovery VERS (incorporating both sensible and latent recovery) or with sensible-only VERS tested under Standard Rating Condition D:

$$C_{D_x} = 1 + 1.40 \cdot (1 - LF_x) \quad 21$$

MRC_{Tgx} and LF_x are calculated as follows:

For DX-DOAS without VERS or with deactivated VERS:

$$MRC_{Tgx} = 3600 \cdot 1.20 \cdot Q_{SA,x}(W_{OA,x} - W_{SA,A}) \quad 22$$

$$LF_x = \frac{(W_{OA,x} - W_{SA,A})}{(W_{OA,x} - W_{SA,Low})} \quad 23$$

For DX-DOAS with VERS tested using Option 1:

$$MRC_{Tgx} = 3600 \cdot 1.20 \cdot Q_{SA,x} ((W_{OA,x} - W_{SA,A}) - EATR_{DOAS} \cdot (W_{OA,x} - W_{RA,x})) \quad 24$$

$$LF_x = \frac{(W_{OA,x} - \epsilon_L \cdot (W_{OA,x} - W_{RA,x}) - W_{SA,A})}{(W_{OA,x} - \epsilon_L \cdot (W_{OA,x} - W_{RA,x}) - W_{SA,Low})} \quad 25$$

For sensible-only VERS, ϵ_L is set equal to $EATR_{DOAS}$ for the LF_x calculation.

For DX-DOAS with VERS tested using Option 2:

$$MRC_{Tgx} = 3600 \cdot 1.20 \cdot Q_{SA,x} ((W_{OA,x} - W_{SA,A}) - EATR_{DOAS} \cdot (W_{OA,x} - W_{RA,x})) \quad 26$$

Where $W_{OA,x}$ is calculated using the measured barometric pressure and the Outdoor Ventilation Air dry bulb and wet bulb temperatures specified in Table 4 and Table 5.

$$LF_x = \frac{(W_{SV,x} - W_{SA,A})}{(W_{SV,x} - W_{SA,Low})} \quad 27$$

For all three cases, $W_{SA,Low}$ is the measured Supply Air humidity ratio for Standard Rating Condition x when operating at the lowest capacity stage.

6.9.2.1 Conduct two tests, the first using the lowest-capacity stage, and the second with compressors turned off, or

6.9.2.2 Conduct one test for which the power input and electric energy use of the compressor and the condenser fans are separately measured.

6.10 Heating Capacity. Calculate the DX-DOAS heating capacity ($q_{hp,y,x}$) in accordance with 6.10.2 for units equipped with VERS and tested under Option 2. Otherwise calculate the heating capacity ($q_{hp,y,x}$) in accordance with 6.10.1. In both cases y represents the rating purpose (full, DOAS, or IS COP), x represents the Outdoor Air standard rating condition, and T_{SA} is the supply air temperature used for the calculation as indicated in Table 11.

Table 10. Heating Capacity Tests	
Subscript of y in $q_{hp,y,x}$ and $COP_{y,x}$	Rating Purpose
Full	Full Capacity Heating (Application Ratings for manufacturer-specified outdoor conditions)
DOAS	Reported Heating Capacity and COP (Condition E mandatory and Condition F optional)
IS COP	Values used for IS COP2 Calculation (Condition E mandatory and Condition F optional)

When calculating heating capacity values for determination of IS COP2 or reporting DX DOAS performance, and the Supply Air dry bulb temperatures measured for two heating capacity stages bracket the 21 °C to 24 °C range (capacity condition 3), where the Supply Air dry bulb temperature for test 1 is lower than for test 2, first separately calculate $q_{hp,1,y,x}$ and $q_{hp,2,y,x}$, for tests 1 and 2, respectively as indicated in Section 6.10.1 or 6.10.2. Next, calculate test averaging weights as indicated in Section 6.11.3.1. Finally, calculate average heating capacity as indicated in Section 6.11.3.3.

6.10.1 No VERS or VERS tested under Option 1. Calculate the heating capacity ($q_{hp,y,x}$) as shown in Equations 28 and 29.

$$q_{hp,y,x} = (3600 \cdot 1.20 \cdot c_{pSA} \cdot Q_{SA}) \times [(T_{SA} - T_{OA}) - EATR_{DOAS}(T_{RA} - T_{OA})] \quad 28$$

$$c_{pSA} = 1004.65 + 1858.58 \cdot W_{SA} \quad 29$$

6.10.2 With VERS tested under Option 2. Calculate the measured heating capacity and heating capacity ($q_{hp,y,x}$) as shown in Equations 30, 31 and 32.

$$q_{hp,M} = 3600 \cdot 1.20 \cdot Q_{SA} \cdot c_{pSA} \cdot (T_{SA} - T_{SV}) \quad 30$$

$$q_{hp,y,x} = q_{hp,M} + 3600 \cdot 1.20 \cdot Q_{SA} \cdot c_{pSA} \cdot (1 - EATR_{DOAS}) \cdot (T_{SV} - T_{OA}) \quad 31$$

$$c_{pSA} = 1004.65 + 1858.58 \cdot W_{SA} \quad 32$$

6.10.3 For DX-DOAS with VERS, operation with VERS is considered to be the minimum capacity stage for the purpose of these calculations. If $21\text{ }^\circ\text{C} < T_{SA} < 24\text{ }^\circ\text{C}$ for VERS operation without compressor operation, conduct calculations as indicated for capacity condition 2. If $T_{SA} < 21\text{ }^\circ\text{C}$ for VERS operation without compressor operation and $T_{SA} > 24\text{ }^\circ\text{C}$ for the first compressor stage, conduct calculations as indicated for capacity condition 3.

Table 11. Supply Air Temperatures and W Penalty Used for Calculation of Heating Mode Ratings

Measurement	Capacity condition during heating mode measurement(s)	Supply Air Temperature T _{SA} C used for Calculation of heating capacity	Include W Penalty?
Full Capacity Heating (Application Ratings for manufacturer-specified outdoor conditions): $q_{hp,full,x}$, $COP_{full,x}$, where x represents any selected application rating condition.	Any	Measured	No
Reported Heating Capacity and COP (Condition E mandatory and Condition F optional): $q_{hp,DOAS,x}$, $COP_{DOAS,x}$, where x represents Standard Rating Condition E or F.	1. $T_{SA} < 21\text{ }^\circ\text{F}$ for maximum capacity stage	Measured	No
	2. $21\text{ }^\circ\text{C} \leq T_{SA} \leq 24\text{ }^\circ\text{C}$ for a single measurement	Measured	N/A
	3. $T_{SA} < 21\text{ }^\circ\text{C}$ for one measurement and $T_{SA} > 24\text{ }^\circ\text{C}$ for another measurement	Measured separately for test 1 and 2	No
	4. $T_{SA} > 24\text{ }^\circ\text{C}$ for minimum capacity stage	24 $^\circ\text{C}$	N/A
Values used for IS COP2 Calculation (Condition E mandatory and Condition F optional): $q_{hp,ISCOP,x}$, $COP_{ISCOP,x}$, where x represents Standard Rating Condition E or F.	1. $T_{SA} < 21\text{ }^\circ\text{C}$ for maximum capacity stage	21 $^\circ\text{C}$	Yes
	2. $21\text{ }^\circ\text{C} \leq T_{SA} \leq 24\text{ }^\circ\text{C}$ for a single measurement	Measured	N/A
	3. $T_{SA} < 21\text{ }^\circ\text{C}$ for one measurement and $T_{SA} > 24\text{ }^\circ\text{C}$ for another measurement	Measured separately for test 1 and 2	No
	4. $T_{SA} > 24\text{ }^\circ\text{C}$ for minimum capacity stage	24 $^\circ\text{C}$	N/A

6.11 COP Ratings.

6.11.1 Standard Rating Condition F. The Standard Rating Condition F test is optional. If the Standard Rating Condition F test is not conducted, a default value of 1 shall be assigned for $COP_{y,F}$, where y represents the rating purpose (DOAS or IS COP2).

6.11.2 When calculating COP values for determination of IS COP2 and the measured Supply Air dry bulb temperature is less than 21°C for the maximum capacity stage, calculate $COP_{IS COP, x}$ using Equation 33, where x represents the Outdoor Air condition.

$$COP_{IS COP, x} = \frac{q_{hp, IS COP, x}}{P_{T, x} + P_{E, x} + W \text{ HeatPenalty}_x} \quad 33$$

6.11.3 Interpolation method. When calculating COP values for determination of IS COP2 or reporting DX DOAS performance, and the Supply Air dry bulb temperatures measured for two heating capacity stages bracket the 21 °C to 24 °C range (capacity condition 3), where the Supply Air dry bulb temperature for test 1 is lower than for test 2, calculate $COP_{y, x}$ as follows, where y represents the rating purpose (DOAS or IS COP2), and x represents the outdoor air condition. Also use this approach when, for a DX DOAS with VERS, the Supply Air dry bulb temperature is less than 21°C using just the VERS and greater than 24 °C when using the lowest compressor capacity stage.

6.11.3.1 Calculate averaging weights $a_{1, x}, a_{2, x}$ for the two tests 1 and 2 conducted for Standard Rating Condition x (x could be E or F) using Equations 33 and 34. The weights shall be calculated such that the calculated average Supply Air dry bulb temperature equals 24 °C and the sum of the weights is equal to 1.

$$a_{1, x} = \frac{T_{SA, 2, x} - 24^\circ C}{T_{SA, 2, x} - T_{SA, 1, x}} \quad 34$$

$$a_{2, x} = 1 - a_{1, x} \quad 35$$

6.11.3.2. Calculate the weighted average power input for the given Standard Rating Condition by using Equation 36.

$$P_{avg, x} = a_{1, x} \cdot (P_{T, 1, x} + P_{E, 1, x}) + a_{2, x} \cdot (P_{T, 2, x} + P_{E, 2, x}) \quad 36$$

6.11.3.3. Calculate the weighted average heating capacity using Equation 37:

$$q_{hp, avg, y, x} = a_{1, x} \cdot q_{hp, 1, y, x} + a_{2, x} \cdot q_{hp, 2, y, x} \quad 37$$

6.11.3.4. Calculate the COP using Equation 38:

$$COP_{y, x} = \frac{q_{hp, avg, y, x}}{P_{avg, x}} \quad 38$$

6.11.4 In all other cases, calculate $COP_{y, x}$ as shown in Equation 38, where y represents the rating purpose (full, DOAS, or IS COP), and x represents the outdoor air condition:

$$COP_{y, x} = \frac{q_{hp, y, x}}{P_{T, x} + P_{E, x}} \quad 39$$

6.12 Calculation of Integrated Seasonal Coefficient of Performance. IS COP2 is calculated using the following Equation 40. The values are derived from bin hour data and represent a year of operation.

$$IS COP2 = (COP_{IS COP, E} \cdot 0.91) + (COP_{IS COP, F} \cdot 0.09) \quad 40$$

6.13 Calculation of Integrated Seasonal Moisture Removal Efficiency. ISMRE2 is calculated using Equation 41. ISMRE₇₀ is calculated using Equation 42. The weighted values are derived from bin hour data and represent a year of operation.

$$\text{ISMRE2} = (\text{MRE}_A \cdot 0.14) + (\text{MRE}_B \cdot 0.34) + (\text{MRE}_C \cdot 0.39) + (\text{MRE}_D \cdot 0.13) \quad 41$$

$$\text{ISMRE}_{70} = (\text{MRE}_{70,A} \cdot 0.14) + (\text{MRE}_{70,B} \cdot 0.34) + (\text{MRE}_{70,C} \cdot 0.39) + (\text{MRE}_{70,D} \cdot 0.13) \quad 42$$

Section 7. Minimum Data Requirements for Published Ratings

7.1 Minimum Data Required for Published Ratings. As a minimum, Published Ratings shall consist of the following information:

- 7.1.1** Rated Supply Airflow, m³/s
- 7.1.2** COP_{DOAS} (for optional heat pumps), at Standard Rating Conditions, heating, W/W
 - 7.1.2.1** COP_{DOAS,E} (mandatory for optional heat pumps), at Standard Rating Condition E, heating, W/W.
 - 7.1.2.2** COP_{DOAS,F} (optional for optional heat pumps), at Standard Rating Condition F, heating, W/W.
- 7.1.3** EATR (for optional VERS) at neutral pressure difference between Return and Outdoor Airflow, %
- 7.1.4** IS COP2 (for optional heat pumps), W/W
- 7.1.5** ISMRE2, kg of moisture/kW·h
- 7.1.6** MRC, at all Standard Rating Conditions, dehumidification, kg of moisture/h
- 7.1.7** MRE, at all Standard Rating Conditions, dehumidification, kg of moisture/kW·h
- 7.1.8** Power voltage, volts, frequency, Hz, and phase
- 7.1.9** Supply Air temperature in heating and dehumidification modes of operation at all Standard Rating Conditions. If Cycle Reheat is provided then dehumidification Supply Air temperature shall be published with Cycle Reheat on and off, °C.
- 7.1.10** Total Heating Capacity_{DOAS} (q_{hp,DOAS}) (for optional heat pumps), at Standard Rating Conditions, heating, W.
- 7.1.11** Water flow rate (where water is used for heat rejection) at Standard Conditions, L/s.

7.2 Rating Claims. As a minimum, Published Ratings shall include all Standard Rating Conditions. All claims to ratings within the scope of this standard shall include the statement “Rated in accordance with AHRI Standard 921 (SI)”. All claims to ratings outside the scope of this standard shall include the statement “Outside the scope of AHRI Standard 921 (SI)”.

7.2.1 COP and q_{hp} Application Ratings. Wherever COP and q_{hp} Application Ratings are published for heat pump DX-DOAS Units the Supply Air dry bulb temperature at the same compressor capacity shall be displayed.

Section 8. Operating Requirements

8.1 Operating Requirements. DX-DOAS Units shall comply with the provisions of this Section such that any production unit will meet the requirements detailed herein.

8.2 Maximum Operating Conditions Test. DX-DOAS Units shall pass the following maximum dehumidification and heating operating conditions test with a leaving airflow rate as specified by the manufacturer.

- 8.2.1 Temperature Conditions.** Temperature conditions shall be maintained as shown in Tables 4 and 5.
- 8.2.2 Voltages.** Tests shall be run at the minimum and maximum utilization voltages as shown in AHRI Standard 110 at the unit's service connection and rated frequency.
- 8.2.3 Procedure.**

8.2.3.1 DX-DOAS Units shall be operated continuously for one hour at the temperature conditions and voltage(s) specified.

8.2.3.2 All power to the equipment shall be interrupted for a period sufficient to cause the compressor to stop (not to exceed five seconds) and then be restored.

8.2.4 *Requirements.*

8.2.4.1 During both tests, the equipment shall operate without failure of any of its parts.

8.2.4.2 The unit shall resume continuous operation within one hour of restoration of power and shall then operate continuously for one hour. Operation and resetting of safety devices prior to establishment of continuous operation is permitted.

8.3 *Dehumidification Low Temperature Operation Test.* DX-DOAS Units shall pass the following low-temperature operation test when operating with initial airflow rates as specified by the manufacturer with controls and dampers set to produce the maximum tendency to frost or ice the conditioning coil, provided such settings are not contrary to the manufacturer's instructions to the user.

8.3.1 *Temperature Conditions.* Temperature conditions shall be maintained at the Standard Rating D Conditions as shown in Tables 4 and 5.

8.3.2 *Voltage and Frequency.* The test shall be performed at nameplate rated voltage and frequency. For DX-DOAS Units with dual nameplate voltage ratings, tests shall be performed at the lower of the two voltages.

8.3.3 *Procedure.* The test shall be continuous with the DX-DOAS Units in the dehumidification cycle for not less than four hours after establishment of the specified temperature conditions. The unit will be permitted to start and stop under control of an automatic limit device, if provided.

8.3.4 *Requirements.*

8.3.4.1 During the entire test, the equipment shall operate without damage.

8.3.4.2 During the entire test, the airflow rate shall not drop more than 5% from that specified for the Standard Rating test.

8.3.4.3 During all phases of the test and during the defrosting period after the completion of the test, all ice or meltage shall be caught and removed by the drain provisions.

8.4 *Voltage Tolerance Test.* DX-DOAS Units shall pass the following voltage tolerance test with a leaving airflow rate as specified by the manufacturer.

8.4.1 *Temperature Conditions.* Temperature conditions shall be maintained at the standard dehumidification (and/or standard heating, as required) steady state conditions as shown in Tables 4 and 5.

8.4.2 *Voltages.*

8.4.2.1 Tests shall be run at the minimum and maximum utilization voltages from AHRI Standard 110 based upon the unit's nameplate rated voltage(s). These voltages shall be supplied at the unit's service connection and at rated frequency. A lower minimum or a higher maximum voltage shall be used, if listed on the nameplate.

8.4.2.2 The power supplied to single-phase equipment shall be adjusted just prior to the shutdown period so that the resulting voltage at the unit's service connection is 86% of nameplate rated voltage when the compressor motor is on locked-rotor. (For 200V or 208V nameplate rated equipment, the restart voltage shall be set at a minimum of 180V when the compressor motor is on locked rotor). Open circuit voltage for three-phase equipment shall not be greater than 90% of nameplate rated voltage.

8.4.2.3 Within one minute after the equipment has resumed continuous operation (Section 8.4.4.3), the voltage

shall be restored to the values specified in Section 8.4.2.1.

8.4.3 *Procedure.*

8.4.3.1 The equipment shall be operated for one hour at the temperature conditions and voltage(s) specified.

8.4.3.2 All power to the equipment shall be interrupted for a period sufficient to cause the compressor to stop (not to exceed five seconds) and then be restored.

8.4.4 *Requirements.*

8.4.4.1 During both tests, the equipment shall operate without failure of any of its parts.

8.4.4.2 The equipment shall operate continuously without interruption for any reason for the one hour period preceding the power interruption.

8.4.4.3 The unit shall resume continuous operation within two hours of restoration of power and shall then operate continuously for one half hour. Operation and resetting of safety devices prior to establishment of continuous operation is permitted.

Section 9. Marking and Nameplate Data

9.1 *Marking and Nameplate Data.* As a minimum, the nameplate shall display the manufacturer’s name, model designation, refrigerant designation per ASHRAE 34, and electrical characteristics. Nameplate voltages for 60 Hz systems shall include one or more of the equipment nameplate voltage ratings shown in Table 1 of AHRI Standard 110.

Section 10. Conformance Conditions

10.1 *Conformance.* While conformance with this standard is voluntary, conformance shall not be claimed or implied for products or equipment within the standard’s *Purpose* (Section 1) and *Scope* (Section 2) unless such product claims meet all of the requirements of the standard and all of the testing and rating requirements are measured and reported in complete compliance with the standard. Any product that has not met all the requirements of the standard shall not reference, state, or acknowledge the standard in any written, oral, or electronic communication.

Section 11. Symbols and Subscripts

11.1 The symbols and subscripts used in AHRI Standard 920 (I-P) are listed and defined below:

$a_{1,x}$	Averaging weight
$a_{2,x}$	Averaging weight
A_{duct}	Surface area of the duct, m ² .
c_{pOA}	Specific heat of Outdoor Air, J/(kg _{da} ·°C)
c_{pSA}	Specific heat of Supply Air, J/(kg·°C).
C	396.25 W/(L/s) based on 6.1 m external head.
C_{Dx}	Coefficient of degradation for compressor and condenser fan power input.
$COP_{y,x}$	COP for determination of application ratings for use with ISCOP2, full, or DOAS at Standard Rating Condition x, W/W. A summary of applications is included in Section 6.10, W/W
COP_x	COP for Standard Rating Condition x, W/W
ϵ_z	Sensible or latent effectiveness, dimensionless. The subscript z, where z= S for sensible or z= L for latent, designates sensible or latent effectiveness values.
$\epsilon_{z,75}$	Sensible or latent effectiveness at 75% nominal Supply Airflow and zero pressure differential, dimensionless. Values from AHRI Standard 1061 (SI) testing or ratings.
$\epsilon_{z,100}$	Sensible or latent effectiveness at 100% nominal Supply Airflow and zero pressure differential, dimensionless. Values from AHRI Standard 1061 (SI) testing or ratings.
$EATR_{DOAS}$	EATR as a fraction, representing leakage/transfer airflow divided by DX-DOAS Supply Airflow. Equal to

	zero for DX-DOAS units not equipped with VERS.
EATR ₀	EATR as a fraction for zero pressure differential and zero purge angle as determined in accordance with AHRI Standard 1061 (SI).
LF _x	Load factor equal to the target MRC, divided by the lowest-capacity stage MRC.
m _c	Weight of condensate collected during the primary test, kg
MRC	Moisture removal capacity, kg/h
MRC _{1,x}	MRC for first of two weighted average tests at Standard Rating Condition x, kg _{water} /h
MRC _{2,x}	MRC for second of two weighted average tests at Standard Rating Condition x, kg _{water} /h
MRC _{avg,x}	Weighted average MRC at Standard Rating condition x, kg _{water} /h
MRC _{secondary}	Moisture removal capacity for the secondary test, kg/h
MRC _{Tgx}	Target moisture removal capacity for Standard Rating Condition x, calculated (a) for DX-DOAS without VERS or DX-DOAS with VERS tested under Option 1 using the Outdoor Ventilation Air humidity ratio measured for Standard Rating Condition x and the Supply Air humidity ratio measured for Standard Rating Condition A, kg/h, and (b) for DX-DOAS with VERS tested using Option 2 using an Outdoor Ventilation Air humidity ratio calculated using the measured barometric pressure and the specified Standard Rating Condition x dry bulb and wet bulb temperatures and the Supply Air humidity ratio measured for Standard Rating Condition A, kg/h. (Informative note – See Appendix D for sample calculations of MRC _{Tgx})
MRC _x	MRC for standard rating condition x (x can be A, B, C, or D), kg _{water} /h
MRE _x	MRE for Standard Rating Condition x (x can be A, B, C, or D), kg/kW·h
MRE _{70,x}	MRE rating incorporating the impact of the Supplementary Heat Penalty at Standard Rating Condition x (x can be A, B, C, or D), kg/kW·h
MRM	Moisture removal measured when testing DX-DOAS units equipped with VERS under Option 2, kg/h.
ΔP	Water-pressure drop measured across liquid heat exchanger, kPa.
P _{avg,x}	Weighted average power input for calculating MRE and COP at Standard Rating condition x, W
P _{70,avg,x}	Weighted average power input for calculating MRE ₇₀ at Standard Rating Condition x, W
P _{bar}	Barometric pressure, kPa.
P _{CCx}	Power input of the compressor and condenser fans for Standard Rating Condition x for operation at the lowest-capacity stage, W. Separately metered if a single test is conducted or equal to PT _x – PR _x if two tests are conducted.
P _{E,x}	Water pump effect for Standard Rating Condition x, applicable for water-cooled and water-source heat pump DX-DOAS units without integral pumps, W.
P _{E,1,x}	Water pump effect, applicable for water-cooled and water-source heat pump DX-DOAS units without integral pumps, for test 1, W. For air-cooled or air-source heat pump DX-DOAS units, P _E =0.
P _{E,2,x}	Water pump effect, applicable for water-cooled and water-source heat pump DX-DOAS units without integral pumps, for test 2, W. For air-cooled or air-source heat pump DX-DOAS units, P _E =0. P _{T,x} = Measured total power input for Standard Rating Condition x, W
P _{NCx}	Power input of the unit not including the compressor and condenser fans, W. Equal to PT _x - P _{CCx} if a single test is conducted or equal to total input power for the no-compressor test, PR _x , if two tests are conducted.
P _{T,x}	Measured total power input for Standard Rating Condition x when operating at the lowest-capacity stage, W.
P _{T,1,x}	Total measured power input for the first of two weighted average tests at Standard Rating Condition x, W.
P _{T,2,x}	Total measured power input for the second of two weighted average tests at Standard Rating Condition x, W.
PP _B	Basic Pumping Penalty (Table 8), W/[(L/s)· kPa)].
q _{hp}	Total Heating Capacity, W.
q _{hp,avg,y,x}	Heating capacity of the two weighted average tests at Standard Rating Condition x for rating purpose y (DOAS or ISCOP), W.
q _{hp,y,x}	Total Heating Capacity for Standard Rating Condition x for rating purpose y (DOAS or ISCOP), W.
q _{hp,1,y,x}	Heating capacity for the first of two weighted average tests at Standard Rating Condition x for rating purpose y (DOAS or ISCOP), W.
q _{hp,2,y,x}	Heating capacity for the second of two weighted average tests at Standard Rating Condition x for rating purpose y (DOAS or ISCOP), W.
q _{hp,DOAS,x}	Total Heating Capacity-DOAS at Standard Rating Condition x, W.
q _{hp,full,x}	Total Heating Capacity-full capacity at Standard Rating Condition x, W
q _{hp,ISCOP,x}	Total Heating Capacity-ISCOP at Standard Rating Condition x, W.
q _{hp,M}	Heating measured when testing DX-DOAS units equipped with VERS under Option 2, W.
q _{hp,VERS,x}	Total Heating Capacity of VERS only operation simulated for Standard Rating Condition x, W.
q _{loss}	Rate of heat loss from the duct between the unit's Supply Air exit and the Supply Air measurement, W.
q _{th,x}	Supplementary heating capacity required to achieve minimum Supply Air temperature, where x represents Standard Rating Condition A, B, C, D, E, or F, expressed in W.

Q_{sc}	Sensible cooling capacity, W.
Q_{tc}	Total Cooling Capacity, W.
Q_{mSA}	Airflow, supply, measured of air-water vapor mixture, m ³ /s.
$Q_{SA,x}$	Airflow, supply, Standard Air at Standard Rating Condition x, m ³ /s
SCFM ₁₀₀	Nominal (100 %) Supply Airflow for AHRI Standard 1061 (SI) testing or rating, m ³ /s.
SCFM _{DOAS}	Supply Airflow for DX-DOAS as measured when setting airflows in accordance with Section 6.1.5, m ³ /s.
t	Time duration of the test, h
T _{OA}	Temperature, Outdoor Air, dry bulb, °C
T _{RA}	Temperature, Return Air, dry bulb, °C
T _{SA}	Temperature, Supply Air, dry bulb, °C
T _{SA,measured}	Measured Supply Air dry bulb temperature, °C.
T _{SA,1,x}	Supply Air dry bulb temperature measured for test 1, adjusted for duct losses, at Standard Rating Condition x, °C
T _{SA,2,x}	Supply Air dry bulb temperature measured for test 2, adjusted for duct losses, at Standard Rating Condition x, °C
T _{SAC}	Supply Air temperature used for calculation of heating capacity, °F.
T _{SV}	Simulated Ventilation Air dry bulb temperature, °C
U	Overall heat transfer coefficient for the duct, W/(m ² ·°C).
v _{SA}	Specific volume of the dry air portion of the Supply Air mixture, m ³ /kg _{da} .
v' _{SA}	Specific volume of Supply Air calculated at atmospheric pressure measured during the test, m ³ /kg _{air-water-mix} .
WF	Liquid flow rate, L/s.
<i>W CoolPenalty</i> _x	Supplementary Cooling Penalty for Standard Rating Condition x, calculated in accordance with Section 6.3, W.
<i>W CoolPenalty</i> _{1,x}	Supplementary Cooling penalty for Standard Rating Condition x, calculated for test 1, in accordance with Section 6.3, W.
<i>W CoolPenalty</i> _{2,x}	Supplementary Cooling penalty for Standard Rating Condition x, calculated for test 2, in accordance with Section 6.3, W.
<i>W HeatPenalty</i> _x	Supplementary Heat Penalty for Standard Rating Condition x, calculated in accordance with Section 6.3, W.
<i>W HeatPenalty</i> _{1,x}	Supplementary Heat penalty for Standard Rating Condition x, calculated for test 1, in accordance with Section 6.3, W.
<i>W HeatPenalty</i> _{2,x}	Supplementary Heat penalty for Standard Rating Condition x, calculated for test 2, in accordance with Section 6.3, W.
W _{OA,x}	Humidity ratio of Outdoor Air at Standard Rating Condition x, kg _{water vapor} /kg _{dry air} .
W _{SA,x}	Humidity ratio of Supply Air at Standard Rating Condition x, kg _{water vapor} /kg _{dry air} .
W _{SA,Low}	the measured Supply Air humidity ratio for Standard Rating Condition x when operating at the lowest capacity stage, kg _{water vapor} /kg _{dry air} .
W _{RA,x}	Humidity ratio of Return Air at Standard Rating Condition x, kg _{water vapor} /kg _{dry air} .
W _{SV,x}	Humidity ratio of Simulated Ventilation Air determined in accordance with Section C4 of Appendix C at Standard Rating Condition x, kg _{water vapor} /kg _{dry air} .
W _{SA,A}	Supply Air Humidity Ratio Measured for Standard Rating Condition A.
W _{SA,1}	Supply Air Humidity Ratio Measured for the first Standard Rating Condition x test.
W _{SA,2}	Supply Air Humidity Ratio Measured for the second Standard Rating Condition x test.
x (MRE tests)	Part load Standard Rating Condition – B, C, or D..
x (COP tests)	Standard Rating Condition E or F.
y	Rating purpose – DOAS,r IS COP, or , or application rating (i.e. full).

APPENDIX A. REFERENCES - NORMATIVE

A1 Listed here are all standards, handbooks and other publications essential to the formation and implementation of the standard. All references in this appendix are considered as part of the standard.

A1.1 AHRI Standard 110-2016, *Air-Conditioning, Heating and Refrigerating Equipment Nameplate Voltages*, 2016, Air-Conditioning, Heating, and Refrigeration Institute, 2311 Wilson Blvd. Suite 400, Arlington, VA 22201, U.S.A.

A1.2 ANSI/AHRI Standard 920 (SI)-2019, *Performance Rating of DX-Dedicated Outdoor Air System Units*, 2019, Air-Conditioning, Heating, and Refrigeration Institute, 2311 Wilson Blvd. Suite 400, Arlington, VA 22201, U.S.A.

A1.3 ANSI/AHRI Standard 1061 (SI)-2014, *Performance Rating of Air-to-Air Energy Recovery Ventilators*, 2014, Air-Conditioning, Heating, and Refrigeration Institute, 2311 Wilson Blvd. Suite 400, Arlington, VA 22201, U.S.A.

A1.4 ANSI/ARI/ASHRAE ISO 13256-1:1998 (SI), *Water-source Heat Pumps Testing and Rating for Performance Part 1: Water-to-Air and Brine-to-Air Heat Pumps*, 1998, International Organization for Standardization, CP 401 - 1214 Vernier, Geneva, Switzerland.

A1.5 ANSI/ASHRAE Standard 198-2013, *Method of Test for Rating DX-Dedicated Outdoor Air System (DX-DOAS) Units*, 2013, American Society of Heating, Refrigerating and Air-Conditioning Engineers, Inc., 1791 Tullie Circle, N.E., Atlanta, GA 30329, U.S.A.

A1.6 ANSI/ASHRAE Standard 37-2009, *Methods of Testing for Rating Electrically Driven Unitary Air-Conditioning and Heat Pump Equipment*, 2009, American Society of Heating, Refrigerating and Air-Conditioning Engineers, Inc., 1791 Tullie Circle, N.E., Atlanta, GA 30329, U.S.A.

A1.7 ANSI/ASHRAE Standard 34-2016, *Designation and Safety Classifications of Refrigeration Systems*, 2016, American Society of Heating, Refrigerating and Air-Conditioning Engineers, Inc., 1791 Tullie Circle, N.E., Atlanta, GA 30329, U.S.A.

A1.8 ANSI/ASHRAE Standard 41.1-2013, *Standard Method for Temperature Measurement*, 2013, American Society of Heating, Refrigerating and Air-Conditioning Engineers, Inc., 1791 Tullie Circle, N.E., Atlanta, GA 30329, U.S.A.

A1.9 ANSI/ASHRAE Standard 41.6-2014, *Standard Method for Humidity Measurement*, 2014, American Society of Heating, Refrigerating and Air-Conditioning Engineers, Inc., 1791 Tullie Circle, N.E., Atlanta, GA 30329, U.S.A.

A1.10 ANSI/ASHRAE/IEC Standard 90.1-2016, *Energy Standard for Building Except Low-Rise Residential Buildings*, 2016, American Society of Heating, Refrigerating and Air-Conditioning Engineers, Inc., 1791 Tullie Circle, N.E., Atlanta, GA 30329, U.S.A.

A1.11 ANSI/ASTM B117-16, *Standard Practice for Operating Salt Spray (Fog) Apparatus*, 2016, 100 Barr Harbor Dr, Conshohocken, PA 19428, U.S.A.

A1.12 ANSI/ASTM G85-11, *Standard practice for Modified Salt Spray (Fog) Testing*, 2011, 100 Barr Harbor Dr, Conshohocken, PA 19428

A1.13 *ASHRAE Terminology*, <https://www.ashrae.org/resources--publications/free-resources/ashrae-terminology>, 2014, American Society of Heating, Refrigerating and Air-Conditioning Engineers, Inc., 1791 Tullie Circle, N.E., Atlanta, GA 30329, U.S.A.

A1.14 CAN/ANSI/AHRI Standard 540-2015, *Performance Rating of Positive Displacement Refrigerant Compressors and Compressor Units*, 2015, Air-Conditioning, Heating, and Refrigeration Institute, 2311 Wilson Blvd. Suite 400, Arlington, VA 22201, U.S.A.

A1.15 10 C.F.R. §431.401, *Petitions for Waiver and Interim Waiver*, 2014, U.S. Department of Energy. 1000

Independence Avenue SW, Washington, D.C., U.S.A.

A1.16 UL 555, *Standard for Fire Dampers*, 2006, Underwriters Laboratories, 333 Pfingsten Road, Northbrook, IL 60062, U.S.A.

A1.17 UL 555S, *Standard for Smoke Dampers*, 2014, Underwriters Laboratories, 333 Pfingsten Road, Northbrook, IL 60062, U.S.A.

APPENDIX B. REFERENCES – INFORMATIVE

B1 Listed here are standards, handbooks, and other publications which may provide useful information and background but are not considered essential. References in this appendix are not considered part of the standard.

None.

APPENDIX C. ANSI/ASHRAE STANDARD 198 and ANSI/ASHRAE STANDARD 37 ADDITIONS, CLARIFICATIONS AND EXCEPTIONS – NORMATIVE

C1 Purpose. The purpose of this appendix is to prescribe the test procedures used for testing DX-DOAS units. The testing of AHRI Standard 921 (SI) shall comply with ANSI/ASHRAE Standard 198 and ANSI/ASHRAE Standard 37 with the following clarifications and exceptions. Where there are contradictions between the standards, follow AHRI Standard 921 (SI).

C2 Test requirements that are deviations from ANSI/ASHRAE Standard 198.

C2.1 Test Unit Location. A single-package air-cooled or air-source DX-DOAS unit shall be installed in a room conditioned to outdoor dry bulb temperatures during the test. If the conditioning system of this chamber cannot maintain the required Outdoor Air humidity level, the Outdoor Ventilation Air and desiccant wheel regeneration air may be ducted from a separate Conditioned Space. If a water-cooled or water-source DOAS, or the Conditioning Coil section of a split system DOAS has a non-ducted conditioning coil air inlet, it shall be installed in a room conditioned to outdoor dry bulb temperatures during the test.

C2.1.1 Outdoor Coil entering air conditions are shown in Table C1 for both Outdoor-Air-Cooled DX-DOAS units and Relief-Air-Cooled DX-DOAS units.

Table C1. Outdoor Coil Entering Air Conditions for Air-Cooled and Evaporatively-Cooled DX-DOAS Units

Air-Cooled Type	Is a VERS Present?	Test Mode	Condition Dry Bulb Temperature of Air Entering Outdoor Coil to the Value Specified in Table 4 for:	Condition Wet Bulb Temperature of Air Entering Outdoor Coil to the Value Specified in Table 4 for:
Outdoor	Yes	Heating	Outdoor Air Dry Bulb	Outdoor Air Wet Bulb
		Dehumidification for DX-DOAS Units with Evaporative Cooling ¹		
		Dehumidification for other DX-DOAS	Outdoor Air Dry Bulb	N/A
	No	Heating	Outdoor Air Dry Bulb	Outdoor Air Wet Bulb
		Dehumidification for DX-DOAS Units with Evaporative Cooling ¹		
		Dehumidification for other DX-DOAS	Outdoor Air Dry Bulb	N/A
Relief	Yes ²	Heating	N/A	N/A
		Dehumidification for DX-DOAS Units with Evaporative Cooling ¹		
		Dehumidification for other DX-DOAS	N/A	N/A
	No	Heating	Return Air Dry Bulb ³	Return Air Wet Bulb ³
		Dehumidification for DX-DOAS Units with Evaporative Cooling ¹		
		Dehumidification for other DX-DOAS	Return Air Dry Bulb ³	N/A

Notes:

1. Also applies to air-cooled DX-DOAS units with condenser cooling enhancement using conditioning coil condensate.
2. Outdoor Coil entering conditions are not controlled when testing Relief-Air-Cooled units with VERS.
3. Control for return air conditions at the inlet to the DX-DOAS unit rather than at the outdoor coil.

C2.1.2 If the Outdoor Air entering the Conditioning Coil section of the unit is ducted from a remote test chamber, there is no wet bulb temperature requirement for the ambient air surrounding the unit unless it is required in accordance with Table C1.

C2.1.3 Desiccant wheel regeneration air entering the DX-DOAS shall be at the Outdoor Ventilation Air dry bulb and wet bulb conditions specified.

C2.1.4 For split system DX-DOAS units, the refrigerant line set shall be at least 7.6 m.

C2.2 *Use of a Single Airflow Rate Measuring Apparatus per Airflow Path.*

C2.2.1 *Supply and Outdoor Airflow Path.* The Outdoor Airflow measuring device illustrated in Figure 1 in ANSI/ASHRAE Standard 198 is not required.

C2.2.2 *Return and Exhaust Airflow Path.* When testing a DX-DOAS unit equipped with a VERS, an airflow rate measuring apparatus is required for Return Airflow. An airflow rate measuring apparatus is not required for Exhaust Airflow.

C2.3 *Outdoor Air.* Outdoor Ventilation Air, Outdoor-Air-Cooled DX-DOAS Outdoor Coil entering air, and desiccant wheel regeneration entering air may be taken from different test rooms. If any of these air streams is provided from a separate room from the room housing the test unit, its corresponding leaving air (i.e. Supply Air, leaving Outdoor Coil air, and leaving regeneration air, respectively) shall be ducted from the unit to the same room from which the air was taken, or pressure relief means (e.g., a separate duct or opening in the separating wall to return air to the first room) shall be provided, if needed to ensure operation at required external static pressures.

C2.4 *Return Air or Test Option 2, Simulated Ventilation Air.* When testing a DX-DOAS with Return Air or Simulated Ventilation Air entering the unit, this air should be taken from a separate room controlled to the specified air conditions during the test.. Ducting or pressure relief means shall be provided so that this air can transfer back to the separate room, and, if applicable, any Outdoor Ventilation Air or simulated ventilation air transferred to the Exhaust Air in the VERS can transfer back to its source.

C2.5 *Plenum and Ducting of Air to or from a DX-DOAS to a Separate Room.* When ducting air between a DX-DOAS and a separate room, into or out of a connection not designed for duct connections in field installation, the following requirements shall be met.

C2.5.1 *Free Air and Ducted Tests.* A preliminary free air test shall be conducted prior to connecting a plenum or ducting to the DX-DOAS. Airflow rates shall be set in accordance with Section 6.1.5 of this standard and meet the operating tolerances defined in of this standard for at least 10 minutes. Record the average airflow rate and average fan power for each airflow path. After connecting the plenum or duct, recheck airflow, adjusting any duct booster fan or the fan of an airflow measurement apparatus attached to the duct as necessary to achieve the required plenum pressure. The unit under test fan settings used for the preliminary free air test shall remain unchanged throughout the remaining tests. Confirm that fan power measured for each airflow path when ducted is within 2% of the power measured for the free air test. Increase plenum size if necessary to match fan power within this 2 % tolerance.

C2.5.2 *Plenum and Duct Requirements.* A plenum (enlarged duct box) shall be installed between the duct and the DX-DOAS. The plenum shall have a cross-sectional area at least 2 times the area of the DX-DOAS inlet or outlet. Plenum length is defined in the following subsections.

C2.5.2.1 For all outlets, the plenum shall extend for a distance of at least 3.5 times the square root of the cross-sectional area of the DX-DOAS outlet prior to any duct transitions, elbows, or air samplers used for air condition measurement.

C2.5.2.2 For all inlets using plenums with ducts connected to booster fans or the fan of an airflow measurement apparatus, the plenum shall extend for a distance of at least 3.5 times the square root of the cross-sectional area of the DX-DOAS inlet prior to any duct transitions, elbows, or air samplers used for air condition measurement.

C2.5.2.3 For all other inlets not covered by Section C2.5.2.2, the plenum shall extend for a distance of at least 2.1 times the square root of the cross-sectional area of the DX-DOAS inlet prior to any duct transitions, elbows, or air samplers used for air condition measurement.

C2.5.2.4 If used, elbows connected to the end of the plenum shall have a centerline radius equal to at least 1.5 times the duct width in the radial direction or have turning vanes. Air velocities calculated as measured volume flow divided by duct or plenum cross-sectional area shall not exceed 76 m/min inside the plenum and 152 m/min in the connecting duct at its connection to the plenum.

C2.5.2.5 When a plenum is attached to an inlet or outlet employing a hood, louvered damper, mist eliminator, these components shall be installed during the test. The inlet or outlet area shall be the smallest cross-sectional open area in the inlet or outlet airflow path that is outboard of any louvers, mist eliminators, or pre-filters. If multiple inlet/outlet openings are used, plenum size shall be based on the sum of the open areas. To avoid restriction of airflow between the hood of downward-facing inlets and outlets and the plenum walls, the plenum shall be sized sufficiently such that the velocity calculated as the measured volume flow divided by the restricted flow area shall be no more than 61 meters per minute. Figures C1 and C2 show plenum construction examples.

C2.5.2.6 Manifolded static pressure taps shall be installed in the plenum in at least four locations spaced uniformly around the plenum per Section 6.5 of ANSIASHRAE Standard 37. For an outlet, the static pressure taps shall be 2.8 times the square root of the cross-sectional area of the outlet from the DX-DOAS. For an inlet, the static pressure taps shall be 1.0 times the square root of the cross-sectional area of the inlet from the DX-DOAS. Static pressure in the plenum shall be maintained within 0.01 kPa of ambient pressure.

C2.5.2.7 If an airflow measurement apparatus is used to measure the airflow passing through the duct, its fan shall be adjusted to meet the plenum static pressure requirement. Otherwise, if the duct pressure drop causes the plenum pressure to differ from ambient pressure by more than 0.01 kPa, an auxiliary adjustable fan shall be installed in the duct to maintain the required plenum pressure. Air samplers used for temperature measurement shall be placed in the duct between the fan and the minimum required plenum length.

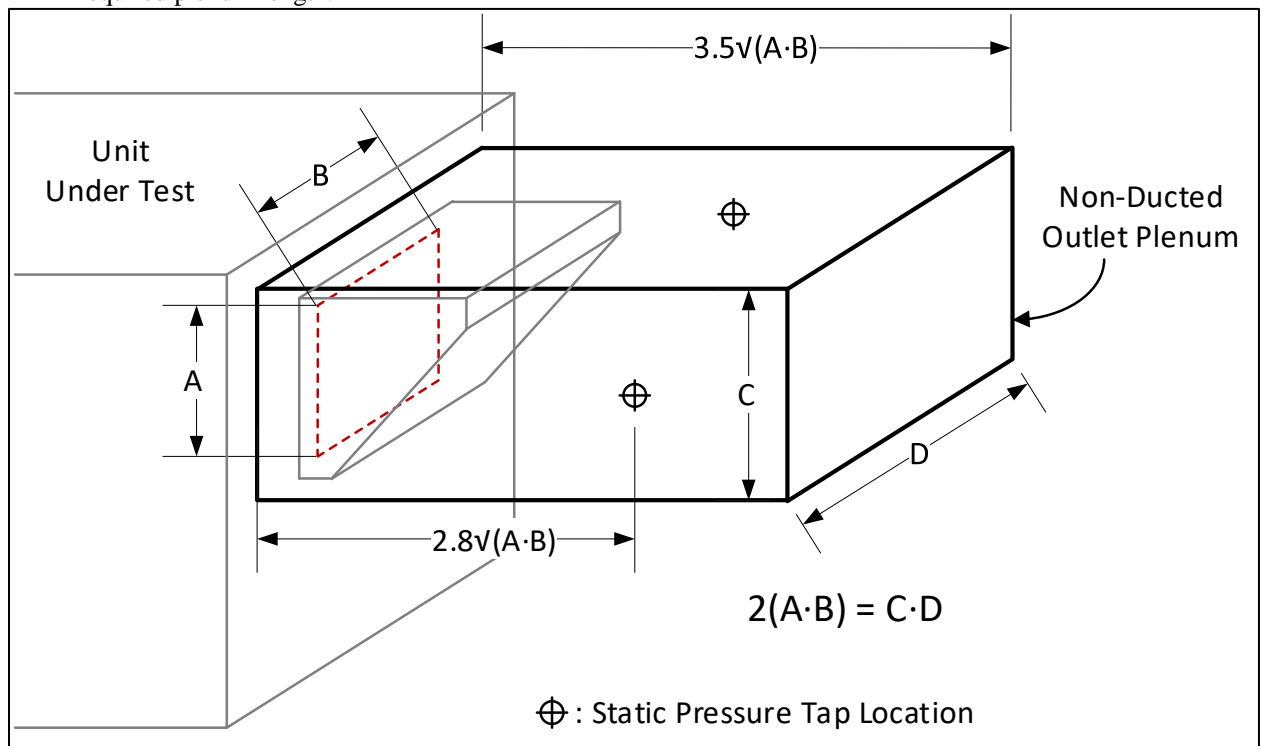
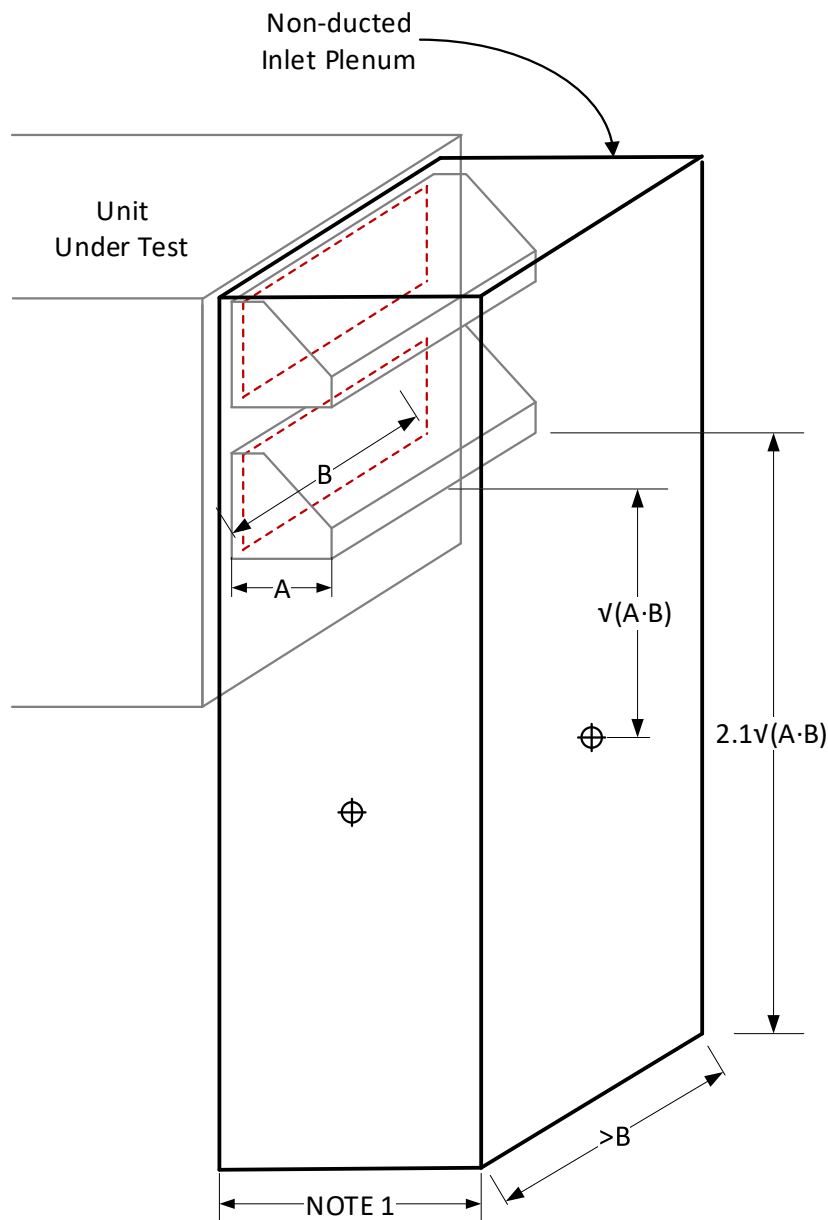

Figure C1. Non-ducted Outlet Plenum



⊕ : Static Pressure Tap Location

Note 1 – Refer to Section C2.5.2.5

Figure C2. Non-Ducted Inlet Plenum (without ducting to booster fan)

C3 Air Condition Measurements. Measure the air dry bulb temperature and water vapor content conditions that are required to be controlled for the test. Measure the Supply Air dry bulb temperature and water vapor content for all tests. Also, when using the Outdoor Air enthalpy method to measure equipment capacity, measure Outdoor Coil leaving air dry bulb temperature and water vapor content. Make these measurements as described in the following Section 3 subsections. Follow Section 5.1.3 of ANSI/ASHRAE Standard 37 regarding relative placement of air temperature and static pressure measurement instruments.

C 3.1 Outdoor Coil Air Entering Conditions. Refer to Table C1

C3.1.1 General Temperature Measurement Requirements. Measure temperatures in accordance with ANSI/ASHRAE Standard 41.1.

C3.1.2 Temperature Measurements. Follow the requirements of Table C1. The specified accuracies shall apply to the full instrument systems including read-out devices. When using a grid of individual thermocouples rather than a thermopile, follow the thermopile temperature requirements of Table C2.

When measuring dry bulb temperature for sampled air within the sampled air conduit rather than with the psychrometer as discussed in Section C3.1.5, use a temperature sensor and instrument system, including read-out devices, with accuracy of $\leq \pm 0.1$ °C and display resolution of ≤ 0.1 °C.

Measurement	Accuracy, °C	Display Resolution, °C
Dry bulb and Wet bulb Temperatures ¹	$\leq \pm 0.1$	≤ 0.1
Thermopile Temperature ²	$\leq \pm 0.6$	≤ 0.1

Notes:

1. The accuracy specified is for the temperature indicating device and does not reflect the operation of the aspirating psychrometer.
2. To meet this requirement, thermocouple wire shall have special limits of error and all thermocouple junctions in a thermopile shall be made from the same spool of wire; thermopile junctions are wired in parallel.

C3.1.3 Psychrometer or Hygrometer Requirements. If measurement of water vapor is required, use one of the following two methods.

C3.1.3.1 Aspirating Psychrometer. The psychrometer consists of a flow section and a fan to draw air through the flow section and measures an average value of the sampled air stream. The flow section shall be equipped with two dry bulb temperature probe connections, one of which shall be used for the facility temperature measurement and one of which shall be available to confirm this measurement using an additional or a third-party’s temperature sensor probe. For applications where the humidity is also required, for testing of evaporatively-cooled units or heat pump products in heating mode, the flow section shall be equipped with two wet bulb temperature probe connection zones of which one shall be used for the facility wet bulb measurement and one of which shall be available to confirm the wet bulb measurement using an additional or a third-party’s wet bulb sensor probe. The Aspirating Psychrometer shall include a fan that either can be adjusted manually or automatically to maintain required velocity across the sensors. A typical configuration for the Aspirating Psychrometer is shown in Figure C3.

C3.1.3.2 Dew Point Hygrometer. Measure dew point temperature using a dew point hygrometer as specified in Sections 4, 5, 6, 7.1, and 7.4 of ANSI/ASHRAE Standard 41.6, with an accuracy of within ± 0.2 °C. Use a dry bulb temperature sensor within the sampled air conduit and locate the dew point hygrometer downstream of the dry bulb temperature sensor.

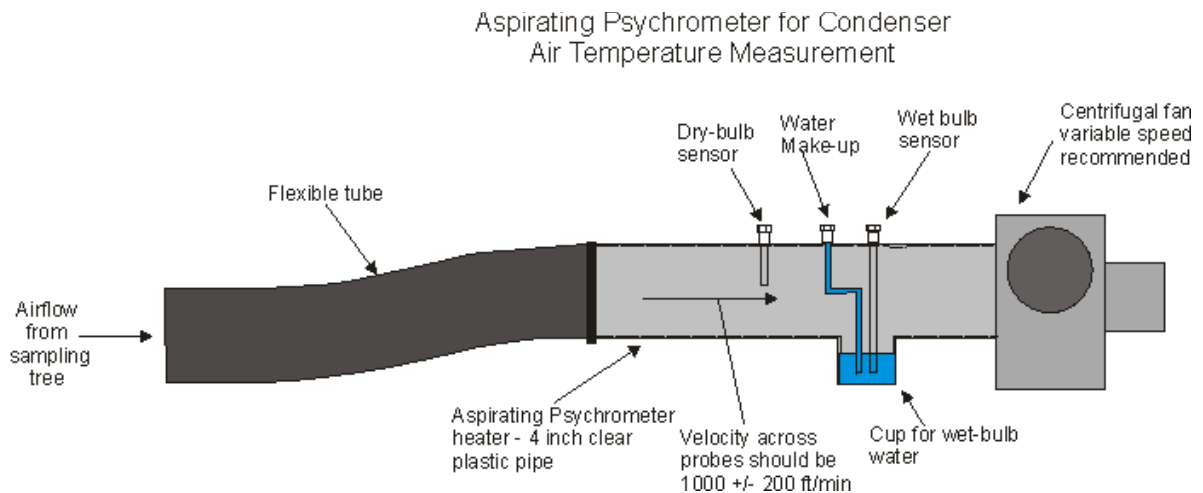

Figure C3. Aspirating Psychrometer

C3.1.4 Air Sampling Tree Requirements. The air sampling tree is intended to draw a uniform sample of the airflow entering the air-cooled condenser section. A typical configuration for the sampling tree is shown in Figure C4 for a tree with overall dimensions of 1.2 m by 1.2 m sample.

Note: Other sizes and rectangular shapes can be used, and should be scaled accordingly as long as the aspect ratio (width to height) of no greater than 2 to 1 is maintained.

It shall be constructed of stainless steel, plastic or other suitable, durable materials. It shall have a main flow trunk tube with a series of branch tubes connected to the trunk tube. The branch tubes shall have appropriately spaced holes, sized to provide equal airflow through all the holes by increasing the hole size as you move further from the trunk tube to account for the static pressure regain effect in the branch and trunk tubes. A minimum hole density of 64 holes per square meter of area to be sampled is required. The minimum average velocity through the sampling tree holes shall be 0.8 m/s as determined by evaluating the sum of the open area of the holes as compared to the flow area in the aspirating psychrometer. The assembly shall have a tubular connection to allow a flexible tube to be connected to the sampling tree and to the aspirating psychrometer.

The sampling tree shall also be equipped with a thermocouple thermopile grid or with individual thermocouples to measure the average temperature of the airflow over the sampling tree. The thermocouple arrangement shall have at least 16 measuring points per sampling tree, evenly spaced across the sampling tree. The air sampling trees shall be placed within 15-30 cm of the unit to minimize the risk of damage to the unit while ensuring that the air sampling tubes are measuring the air going into the unit rather than the room air around the unit.

Note: The “.75 in X .50 in” slots referenced in Figure C4 are cut into the branches of the sampling tree and are located inside of the trunk of the sampling tree. They are placed to allow air to be pulled into the main trunk from each of the branches.

C3.1.4.1 Test Setup Description. The nominal face area of the airflow shall be divided into a number of equal area sampling rectangles with aspect ratios no greater than 2 to 1. Each rectangular area shall have one air sampler tree.

Note: The nominal face area may extend beyond the condenser coil depending on coil configuration and orientation, and shall include all regions through which air enters the unit.

A minimum of one aspirating psychrometer per side of an Outdoor-Air-Cooled DX-DOAS Outdoor Coil section shall be used. For units with three (3) sides, two (2) sampling aspirating psychrometers can be used but shall require a separate air sampler tree for the third side. For units that have Outdoor Coil air entering the sides and the bottom of the unit, additional air sampling trees shall be used.

The air sampler trees shall be located at the geometric center of each rectangle; either horizontal or vertical orientation of the branches is acceptable. The sampling trees shall cover at least 80% of the height and 60% of the width of the air entrance to the unit (for long horizontal coils), or shall cover at least 80% of the width and 60% of the height of the air entrance (for tall vertical coils). The sampling trees shall not extend beyond the face of the air entrance area. The sample trees shall be located 15-30 centimeters from the enter face of the unit. It is acceptable to block all branch inlet holes that extend beyond the face of the unit. Refer to Figure C5 for examples of how an increasing number of air sampler trees are required for longer condenser coils.

A maximum of four (4) sampling trees shall be connected to each aspirating psychrometer. The sampling trees shall be connected to the aspirating psychrometer using flexible tubing that is insulated and routed to prevent heat transfer to the air stream. In order to proportionately divide the flow stream for multiple sampling trees for a given aspirating psychrometer, the flexible tubing shall be of equal lengths for each sampling tree. Refer to Figure C6 for some typical examples of air sampler tree and aspirating psychrometer setups.

If using more than one air sampling tree, all air sampling trees shall be of the same size and have the same number of inlet holes.

Draw air through the air samplers using the fans of the psychrometer(s) or, if not using psychrometers, equivalent fans allowing adjustment of airflow through the air sampler inlet holes as specified in Section C3.1.4 of this appendix. Return the fan discharge air to the room from which the system draws the Outdoor Coil intake air.

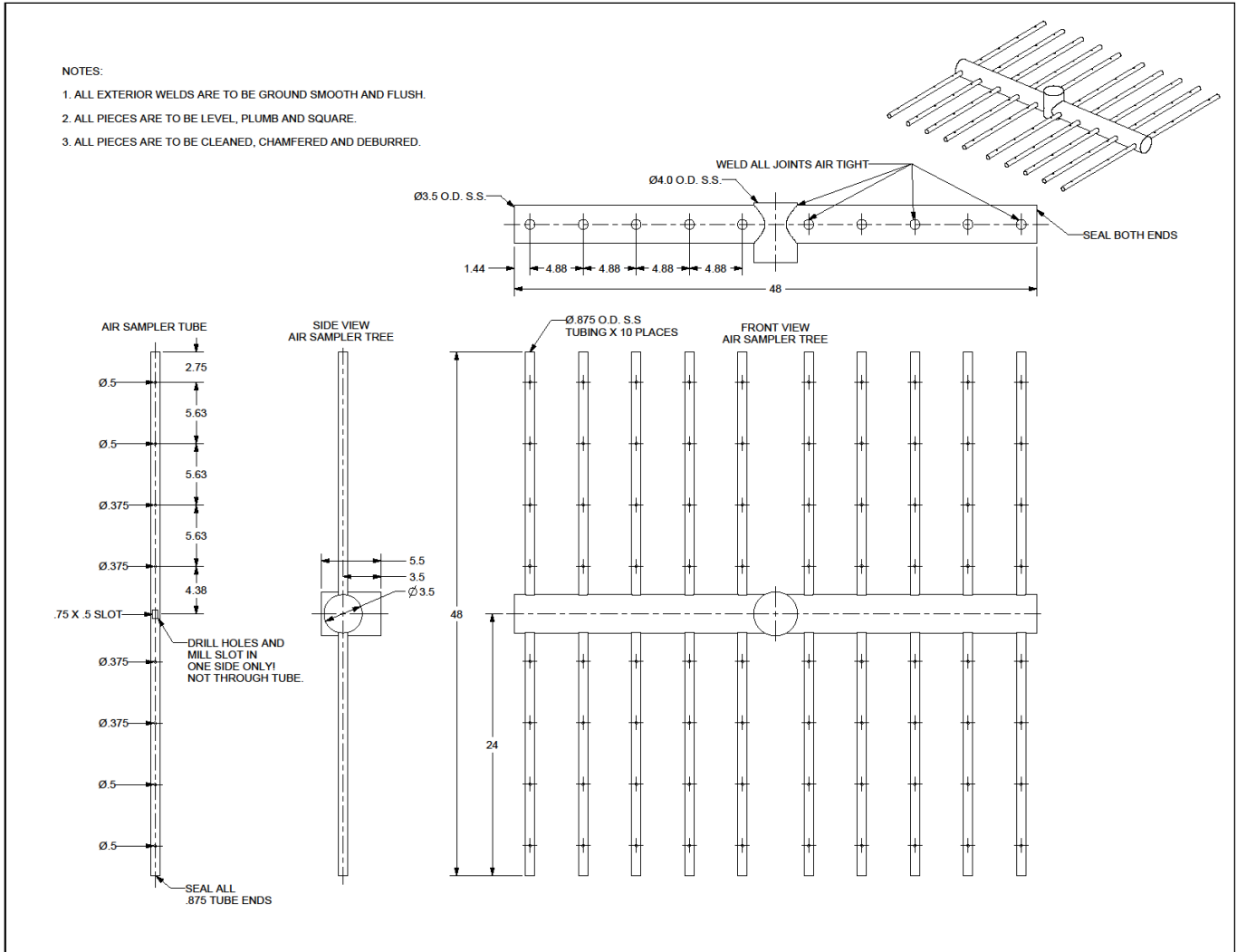

Figure C4. Typical Air Sampling Tree

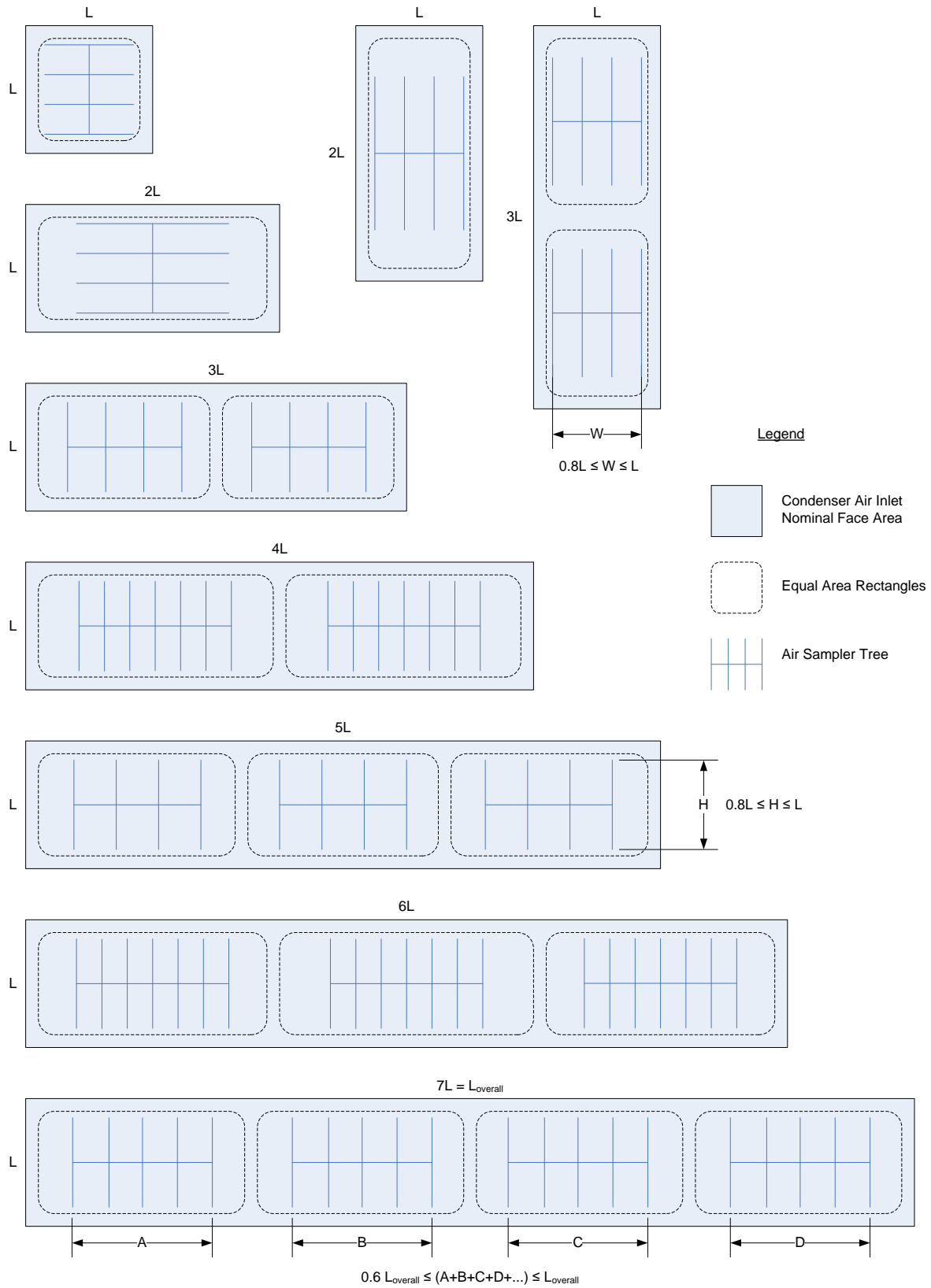

Figure C5. Determination of Measurement Rectangles and Required Number of Air Sampler Trees

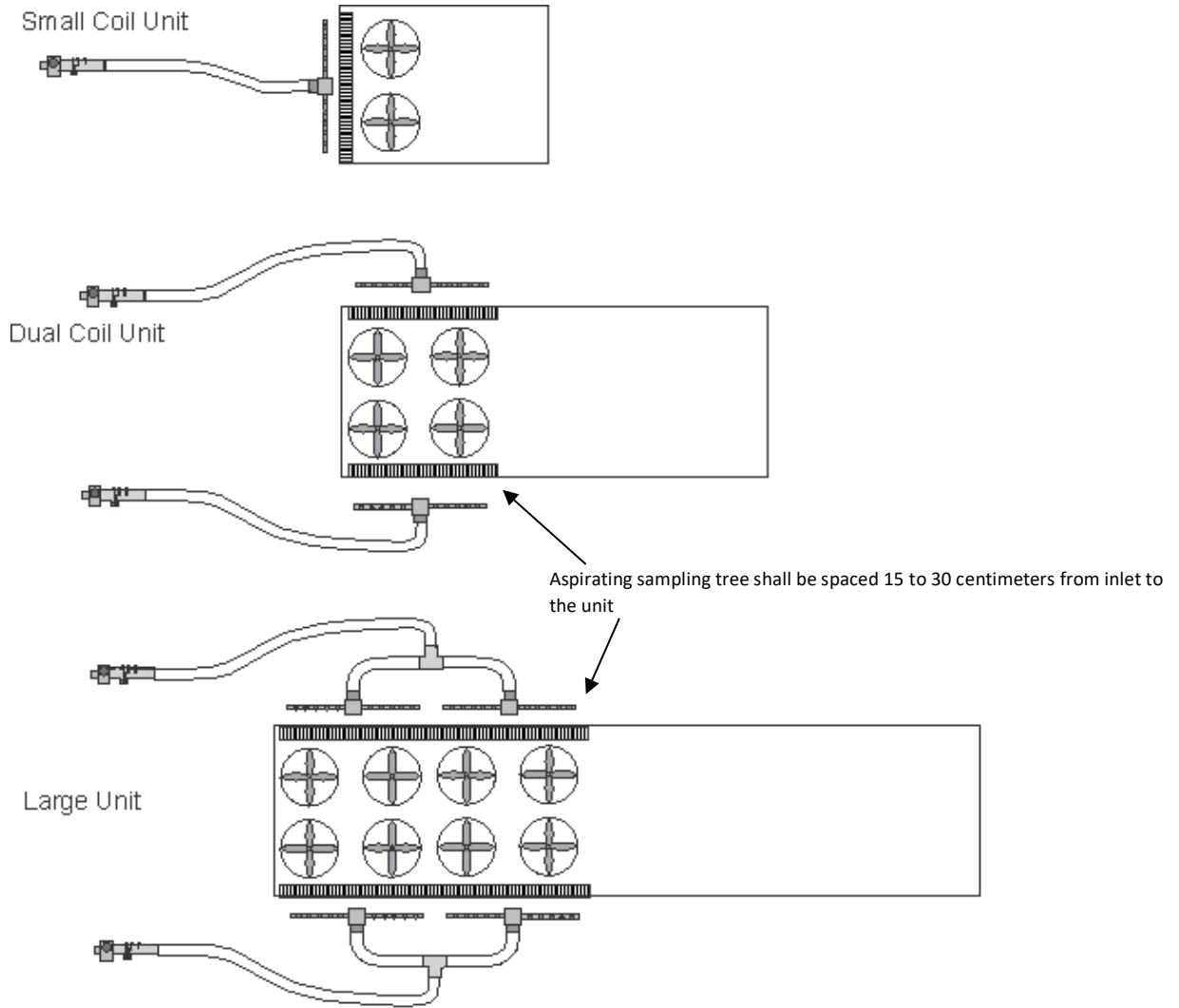

Figure C6. Typical Test Setup Configurations

C3.1.5 Dry Bulb Temperature Measurement. Measure dry bulb temperatures using the psychrometer dry bulb sensors, or, if not using psychrometers, use dry bulb temperature sensors with accuracy as described in Section C3.1.2. Measure the dry bulb temperature within the conduit conducting air sampler air to the fan at a location between the air sampler exit to the conduit and the fan. When a fan draws air through more than one air sampler, the dry bulb temperature may be measured separately for each air sampler or for the combined set of air sampler flows. If dry bulb temperature is measured at the air sampler exit to the conduit, the use of a thermocouple thermopile grid or a grid of individual thermocouples for duplicate measurement of dry bulb temperature is not required—instead use the air-sampler-exit measurement when checking temperature uniformity.

C3.1.6 Wet Bulb or Dew Point Temperature Measurement to Determine Air Water Vapor Content. Measure wet bulb temperatures using one or more psychrometers or measure dew point temperature using one or more hygrometers. If using hygrometers, measure dew point temperature within the conduit conducting air sampler air to the air-sampling fan at a location downstream of the dry bulb temperature measurement. When a fan draws air through more than one air sampler, the dew point temperature may be measured separately for each air sampler or for the combined set of air sampler flows.

When more than one air sampler feeds a single water vapor content measurement instrument, measure relative humidity as required in Section C3.1.8 of this appendix to allow assessment of water vapor content uniformity.

C3.1.7 *Monitoring and Adjustment for Air Sampler Conduit Temperature Change and Pressure Drop.* If dry bulb temperature is measured at a distance from the air sampler exits, determine average conduit temperature change as the difference in temperature between the remote dry bulb temperature and the average of thermopiles or thermocouple measurements of all air samplers collecting air that is measured by the remote dry bulb temperature sensor. If this difference is greater than 0.3 °C, measure dry bulb temperature at the exit of each air sampler (using dry bulb temperature sensors with accuracy as described in Section C3.1.2), and use these additional sensors to determine average coil-entering dry bulb temperature.

Measure gauge pressure at the sensor location of any instrument measuring water vapor content. If the pressure differs from room pressure by more than 0.5 kPa, use the gauge pressure measurement to adjust the atmospheric pressure used to calculate the humidity ratio (in units of kilograms of moisture per pound of dry air) at the measurement location.

If either the 0.3 °C temperature difference threshold or the 0.5 kPa pressure difference threshold are exceeded, use a two-step process to calculate adjusted air properties (*e.g.*, wet bulb temperature or enthalpy) for the one or more affected air samplers. First, calculate the moisture level (kilograms of water vapor per kilogram dry air) at the humidity measurement location(s) using either the psychrometer dry bulb and wet bulb temperature measurements or the hygrometer dew point measurement, using for either approach the adjusted pressure, if it differs from the room atmospheric pressure by 0.5 kPa or more. Then calculate the air properties for the air sampler location based on the moisture level, the room atmospheric pressure, and the dry bulb temperature at the air sampler location. If the air sampler fan or psychrometer serves more than one air sampler, and the 0.3 °C threshold was exceeded, the dry bulb temperature used in this calculation shall be the average of the air sampler exit measurements. Also, for multiple air samplers, if humidity was measured using multiple hygrometers, the moisture level used in this calculation shall be the average of the calculated moisture levels calculated in the first step.

C3.1.8 *Temperature Uniformity.* To ensure adequate air distribution, thorough mixing, and uniform air temperature, it is important that the room and test setup is properly designed and operated. The room conditioning equipment airflow shall be set such that recirculation of condenser discharged air is avoided except as may naturally occur from the equipment. To check for the recirculation of condenser discharged air back into the condenser coil(s) the following method shall be used: Multiple individual reading thermocouples (at least one per sampling tree location) shall be installed around the unit air discharge perimeter so that they are below the plane of condenser fan exhaust and just above the top of the condenser coil(s). These thermocouples shall not indicate a temperature difference greater than 2.8 °C from the average inlet air. Air distribution at the test facility, at the point of supply to the unit, shall be reviewed to determine if it requires remediation prior to beginning testing.

Mixing fans can be used to ensure adequate air distribution in the test room. If used, mixing fans shall be oriented such that they are pointed away from the air intake so that the mixing fan exhaust direction is at an angle of 90°-270° to the air entrance to the condenser air inlet. Pay particular attention to prevent recirculation of condenser fan Exhaust Air back through the unit.

When not using psychrometers, the “psychrometer dry bulb temperature measurement” of Table C3 of this appendix refers to either (a) the dry bulb temperature measurement in a single common air conduit serving one or more air samplers or (b) the average of the dry bulb temperature measurements made separately for each of the air samplers served by a single air sampler fan. Similarly, “wet bulb temperature” refers to calculated wet bulb temperatures based on dew point measurements.

Adjust measurements if required by Section C3.1.7 of this appendix prior to checking uniformity.

The 0.8 °C dry bulb temperature tolerance in Table C3 between the air sampler thermopile (thermocouple) measurements and psychrometer measurements only applies when more than one air sampler serves a given psychrometer (see note 2 of Table C3).

The uniformity requirements apply to test period averages rather than instantaneous measurements.

When water vapor content measurement is required, also confirm uniformity of wet bulb temperature variation among air samplers. When more than one air sampler feeds a single aspirating psychrometer or dew point sensor, measure relative humidity of the air external to each of these air samplers using a relative humidity sensor having $\pm 2\%$ relative humidity accuracy located within 7.5 centimeters of geometric center of the air sampler. Calculate wet bulb temperature for these air samplers using the relative humidity measurement and the dry bulb temperature measurements from either the thermopiles (thermocouple grid averages), or the measurements at the air sampler exits. The maximum allowable difference between the calculated wet bulb temperature for any air sampler and the average wet bulb temperature for all air samplers used to measure outdoor entering air conditions is 0.55 °C.

A valid test shall meet the criteria for adequate air distribution and control of air temperature as shown in Table C3.

Table C3. Criteria for Air Distribution and Control of Air Temperature		
Dry bulb Temperature	Purpose	Maximum Variation, °C
Deviation from the mean air dry bulb temperature to the air dry bulb temperature at any individual temperature measurement station ¹	uniform temperature distribution	± 1.10
Difference between dry bulb temperature measured with air sampler tree thermopile and with aspirating psychrometer ²	uniform temperature distribution	± 0.80
Difference between mean dry bulb air temperature and the specified target test value ³	test condition tolerance, for control of air temperature	± 0.30
Mean dry bulb air temperature variation over time (from the first to the last of the data sets)	test operating tolerance, total observed range of variation over data collection time	± 0.80
Wet bulb Temperature ⁴		
Deviation of calculated local air sampler wet bulb temperatures and the mean wet bulb temperature	uniform humidity distribution	± 0.60
Deviation from the mean wet bulb temperature and the individual temperature measurement stations	uniform humidity distribution	± 0.60
Difference between mean wet bulb air wet bulb temperature and the specified target test value ³	test condition tolerance, for control of air temperature	± 0.60
Mean wet bulb air temperature variation over time	test operating tolerance, total observed range of variation over data collection time (from the first to the last of the data sets)	± 0.60
<p>Notes:</p> <ol style="list-style-type: none"> Each measurement station represents an average value as measured by a single Aspirating Psychrometer. Applies when multiple air samplers are connected to a single psychrometer or conduit dry bulb temperature sensor. If the average of the thermopile measurements differs from the psychrometer or conduit dry bulb sensor measurement by more than 0.3 °C, use air-sampler exit dry bulb temperature sensors. For this case, the uniformity requirement is based on comparison of each of the air-sampler exit measurements with the average of these measurements. The mean dry bulb temperature is the mean of all measurement stations. The wet bulb temperature measurement is only required for entering Outdoor Coil air for DX-DOAS units that are evaporatively-cooled or use pan condensate enhance condenser cooling and for air-source heat pump DX-DOAS units operating in the heating mode. 		

C3.2 Outdoor Ventilation Air Conditions. Use these requirements for measuring the DX-DOAS entering conditions of Outdoor Ventilation Air, desiccant regeneration air, simulated ventilation air, or return air.

Follow the requirements for Outdoor Coil entering air conditions as described in Section C3.1 of this appendix, except for the following.

C3.2.1 Both dry bulb temperature and water vapor content measurements are required for all tests.

C3.2.2 If the air is drawn from a remote location (e.g. an adjacent chamber) through a duct system that includes a booster fan or airflow measurement apparatus, the air sampler shall be installed in the duct downstream of the fan or airflow measurement apparatus.

C3.2.3 If air is sampled within a duct, the air sampling tree shall be installed with the rectangle defined by the air sampler inlet holes oriented parallel with and centered in the duct cross-section—this rectangle shall have dimensions that are at least 75% of the duct’s respective dimensions.

C3.2.4 Sampled air shall be returned to the room from which the system draws the Outdoor Ventilation Air, except for the following situations. If the loop air enthalpy test method specified in Section 6.1.2 of ANSI/ASHRAE Standard 37 is used, the sampled air shall be returned upstream of the air sampler either to the duct between the airflow measuring apparatus and the room conditioning apparatus or to the airflow measuring apparatus between the nozzles and the fan. If the air is drawn from a remote location as described in Section C3.2.2 of this appendix through a duct system that includes an airflow measurement apparatus, the sampled air shall be returned to the airflow measuring apparatus between the nozzles and the fan.

C3.3 *Supply Air and Outdoor Coil Leaving Air Conditions.* Follow the requirements for measurement of Outdoor Coil entering air conditions as described in Section C3.1, except for the following.

Both dry bulb temperature and water vapor content measurements are required for Supply Air for all tests and for Outdoor Coil leaving air for all tests using the Outdoor Air enthalpy method.

Supply Air and Outdoor Coil leaving air that is drawn from the unit discharge duct into the air sampling tree for measurement shall be returned to the duct just downstream of the air sampling tree and upstream of the airflow-measuring apparatus. Insulate the conduit transferring the air from the air sampler fan discharge to the duct.

The air sampling tree (used within the duct transferring air to the airflow measurement apparatus) shall be installed with the rectangle defined by the air sampler inlet holes oriented parallel with and centered in the duct cross-section—this rectangle shall have dimensions that are at least 75% of the duct’s respective dimensions.

C3.3.1 *Blow-through Coil.* For a coil with a blow-through fan (i.e., where the fan is located upstream of the coil), use a grid of individual thermocouples rather than a thermopile on the air sampling tree, even if air-sampler-exit dry bulb temperature measurement instruments are installed. If the difference between the maximum time-averaged thermocouple measurement and the minimum time-averaged thermocouple measurement is greater than 0.8 °C, install mixing devices such as those described in Sections 5.3.2 through 5.3.3 of ANSI/ASHRAE Standard 41.1 to reduce the maximum temperature spread to less than 0.8 °C.

C4 *Simulated Ventilation Air Conditions for Testing Under Option 2.* This section applies to setting the simulated ventilation air conditions for testing DX-DOAS units equipped with VERS under Option 2 under dehumidification and heating modes. Use the Supply Airflow rate determined for the DX-DOAS when setting airflow rates as described in Section 6.1.5 of this standard to establish the effectiveness values and EATR determined based on AHRI Standard 1061 (SI) to calculate the simulated ventilation air conditions.

C4.1 For DX-DOAS units equipped with an Energy Recovery Wheel, adjust the EATR to DX-DOAS Supply Airflow rate conditions:

$$EATR_{DOAS} = EATR_0 \cdot \frac{SCFM_{100}}{SCFM_{DOAS}} \quad C1$$

If AHRI Standard 1061 (SI) information is not available, or if the Energy Recovery Wheel rotational speed has been changed from the speed used to determine AHRI 1061 (SI) ratings, set EATR_{DOAS} equal to 0.065.

C4.2 Determination of the Effectiveness. Calculate the sensible effectiveness (for dehumidification and heating modes) and latent effectiveness (for dehumidification mode) for the VERS as installed in the DX-DOAS, for 0 kPa pressure differential, leaving supply static pressure minus entering exhaust (return) static pressure using AHRI Standard 1061 (SI) certified ratings as shown in Equation C2.

$$\epsilon_z = \epsilon_{z,100} + (\epsilon_{z,75} - \epsilon_{z,100}) \frac{(SCFM_{100} - SCFM_{DOAS})}{0.25 \cdot SCFM_{100}} \tag{C2}$$

For VERS that are capable of sensible heat transfer only, the latent effectiveness is equal to 0.

If AHRI Standard 1061 (SI) performance information is not available for the VERS, or if, for an Energy Recovery Wheel, the rotational speed has been changed from the speed used to determine AHRI 1061 (SI) ratings, use the default effectiveness values provided in Table C4 corresponding to the kind of VERS system used in the DX-DOAS.

VERS System	Sensible Effectiveness (dehumidification/heating, %)	Latent Effectiveness (dehumidification, %)
Plate Heat Exchanger	49	28
Heat Pipe	21.5	0
Energy Recovery Wheels	50	50

For dehumidification mode, calculate both sensible and latent effectiveness using the equations provided in this section. For heating mode, only the sensible effectiveness is required.

C4.3 Calculating Simulated Ventilation Air Conditions. Using the sensible and latent effectiveness values, ϵ_z , calculate the simulated ventilation air dry bulb and humidity ratio conditions as follows for each Standard Rating Condition (A, B, C, D for dehumidification; E and F for heating), except as noted in C4.4:

$$T_{SV} = T_{OA} - \epsilon_S \cdot (T_{OA} - T_{RA}) \tag{C3}$$

$$W_{SV} = W_{OA} - \epsilon_L \cdot (W_{OA} - W_{RA}) \tag{C4}$$

T refers to dry bulb temperature expressed as °C, W refers to humidity ratio calculated for the Outdoor Air and Return Air Standard Rating Condition dry bulb and wet bulb temperatures at the measured barometric pressure, and ϵ refers to effectiveness. The subscripts S and L refer to sensible and latent, OA refers to Outdoor Air, SV refers to Simulated Ventilation Air, RA refers to Return Air. Use the Outdoor Air and Return Air conditions as specified for the Standard Rating Conditions in Tables 4 and 5 of this standard.

For sensible-only VERS, calculate W_{SV} using ϵ_L set equal to $EATR_{DOAS}$.

Using the dry bulb temperature and humidity ratio calculated in Equations C3 and C4 and the atmospheric pressure measured during the test in accordance with Section 5.12.10 of this standard, calculate the corresponding wet bulb temperature for the simulated ventilation air using equations in ASHRAE Fundamentals Chapter 1. Set the Outdoor Air and Return Air conditions equal to the calculated Simulated Ventilation Air conditions.

C4.4 Simulation of Energy Recovery Wheel Deactivation (per Section 5.4.3). If specified by the manufacturer for Standard Rating Condition D, simulate deactivation of an Energy Recovery Wheel by using Outdoor Air conditions in place of the calculated Simulated Ventilation Air conditions. Also, de-energize VERS powered components (e.g. Energy Recovery Wheel rotation motors) and open optional dampers, as they would be during deactivation in field operation.

C5 Secondary Verification.

C5.1 Dehumidification Capacity Verification. For all DX-DOAS units that (a) do not use condensate collected from the dehumidification coil to enhance condenser cooling or include a secondary dehumidification process for which the moisture removed from the Supply Air is not collectable in liquid form, and (b) either are not equipped with VERS or are equipped with VERS and tested using Option 2, a secondary dehumidification capacity measurement is required for

all dehumidification tests. Match of capacity measurements is required only for Standard Rating Condition A. A secondary dehumidification capacity measurement is not required for DX-DOAS units equipped with VERS that are tested using Option 1.

C5.1.1 The cooled condensate that drains out from the condensate collection pan shall be collected into a tank with sufficient capacity. For units that use condensate collected from the dehumidification coil to enhance condenser cooling and units that include a secondary dehumidification process for which the moisture removed from the Supply Air is not collectable in liquid form, conduct a separate test making both primary and secondary MRC measurements using Standard Rating Condition A for which the condensate is not transferred to the condenser or the secondary dehumidification process is deactivated to verify dehumidification capacity.

C5.1.2 *Measurement of the Weight of the Collected Condensate.* The weight of the tank used to measure the collected condensate shall be recorded before and after the test (i.e., before and after condensate is collected in the tank) using a weighing scale with accuracy of $\pm 1\%$ of the total condensate mass.

Calculation of Moisture Removal Capacity. $MRC_{SECONDARY}$ is calculated based on the following equation:

$$MRC_{secondary} = \left(\frac{m_c}{t} \right) \quad C5$$

C5.2 *Heating Capacity Verification.* For all DX-DOAS Units that are not equipped with VERS, and DX-DOAS units equipped with VERS that are tested using Option 2, a secondary heating capacity measurement is required for all heating tests, except as indicated in Section C5.2.1. Match of capacity measurements is required only for Standard Rating Condition E. A secondary heating capacity measurement is not required for DX-DOAS units equipped with VERS that are tested using Option 1. The secondary measure of total heating capacity shall be performed using the Outdoor Air enthalpy, refrigerant enthalpy, compressor calibration, or outdoor liquid coil test methods (as applicable) per Sections 7.3, 7.4, 7.5, 7.6 and 8.6 of ANSI/ASHRAE 37, respectively. Also refer to Table 1 (except for indoor air enthalpy method and Cooling condensate and indirect airflow measurement) of ANSI/ASHRAE Standard 37 to determine applicable test methods.

C5.2.1 Secondary measurement of heating capacity is not required on single package air-source heat pumps with a certified Supply Airflow rate greater than 45 m³/min. (b) Secondary measurement of heating capacity is required only for Standard Rating Condition E for single-package air-source heat pumps with a certified Supply Airflow Rate less than or equal to 45 m³/min.

C5.2.2 Where ANSI/ASHRAE Standard 37 indicates that evaporator and condenser coils shall be placed in separate chambers (for split systems), it is permissible to place both in the same chamber, as shown in ANSI/ASHRAE Standard 198. The required ducting, temperature measurement, and airflow measurement shall be carried out in accordance with ANSI/ASHRAE Standard 37.

C5.2.3 Tolerances specified for “entering Outdoor Air” in Table 2b of ANSI/ASHRAE Standard 37, shall be used as operating tolerances for air entering the evaporator coil.

C5.2.4 *Outdoor Air Enthalpy Method.* Verify the primary test measurement method using the Outdoor Air enthalpy method after first conducting an initial primary test measurement without the outdoor-side test apparatus connected to the Outdoor Coil. Use the initial primary test measurement to establish refrigeration system operating conditions for the verification test. Also use the initial primary test measurement to calculate heating capacity and COP if capacity verification criteria described in Sections C5.2.4.1 and C5.2.4.2 are met. The test without the outdoor air-side test apparatus connected to the outdoor unit is called the “free outdoor air” test. The verification test conducted with the outdoor air-side test apparatus connected is called the “ducted outdoor air” test.

C5.2.4.1 Use the requirements as described in Section 8.6 of ANSI/ASHRAE Standard 37 to measure refrigeration system operating conditions for the free outdoor air test and to duplicate these conditions for the ducted outdoor air test, except that (a) pressure measurement rather than temperature measurement shall be used for any system using a zeotropic refrigerant having a temperature glide in excess of 0.6 °C at the specified test conditions, and (b) the equilibrium and test duration requirements of Section 5.3 of this standard shall apply for any free outdoor air test that is used to calculate system heating capacity and COP.

C5.2.4.2 For the free Outdoor Air test to constitute a valid test for determination of heating capacity and COP, (1) for the ducted outdoor test, the heating capacity using the Outdoor Air enthalpy method shall be within 6 % of the primary method heating capacity measurement, and (2) the primary test method heating capacity measurements of the ducted Outdoor Air and free Outdoor Air tests shall agree within 2%.

C5.2.5 *Outdoor Liquid Coil Method.* Use the equations specified in section 7.6.5.1 of the Errata Sheet to ANSI/ASHRAE Standard 37 when using the outdoor liquid coil method for heating capacity measurement.

C5.2.6 *Adjustment to ANSI/ASHRAE Standard 37 Calculation of Secondary Capacity for Outdoor Air Enthalpy Method and Outdoor Liquid Coil Method.* Rather than using E_t , total power input, to adjust the measured outdoor coil load to obtain heating capacity, use the outdoor capacity method power calculated as follows.

$$P_{OCM} = P_C + P_{CD} + P_{SF} + F_{EF} \cdot P_{EF} \tag{C6}$$

Where:

P_C is the compressor power input;

P_{CD} is the condenser fan or onboard pump power input;

P_{SF} is the supply fan power input;

P_{EF} is the exhaust fan power input; and

F_{EF} is equal to:

- 0, zero, for DX-DOAS with VERS where the exhaust fan is downstream of the VERS;
- ϵ_{LS} , heating mode sensible effectiveness of the VERS, for DX-DOAS with VERS where the exhaust fan is upstream of the VERS; and
- 1, one, for relief-air-cooled DX-DOAS.

C6 Calculate the Supplementary Heat penalty, $W\ HeatPenalty_x$, or the Supplementary Cooling Penalty, $W\ CoolPenalty_x$, expressed in W, as follows:

C6.1 *Supplementary Heat Penalty (if $T_{SA,x} < 21\ ^\circ C$, otherwise $W\ HeatPenalty_x = 0$)*

$$W\ HeatPenalty_x = \frac{q_{th,x}}{1.0} \tag{C7}$$

$$q_{th,x} = 3600 \cdot 1.20 \cdot Q_{SA} \cdot c_{pSA}(21^\circ C - T_{SA,x}) \tag{C8}$$

$$c_p = 1004.65 + 1858.58 \cdot W_{SA} \tag{C9}$$

C6.2 *Supplementary Cooling Penalty (if $T_{SA,x} > 24^\circ C$, otherwise $W\ CoolPenalty_x = 0$)*

$$W\ CoolPenalty_x = \frac{q_{th,x}}{13.0} \tag{C10}$$

$$q_{th,x} = 3600 \cdot 1.20 \cdot Q_{SA} \cdot c_{pSA}(T_{SA,x} - 24^\circ C) \tag{C11}$$

$$c_p = 1004.65 + 1858.58 \cdot W_{SA} \tag{C12}$$

Where:

1004.65 = Specific heat of dry air, J/(kg · °C)

1858.58 = Specific heat of water vapor, J/(kg·°C)

1.0 = Supplementary heat COP (electric resistance heat)

3.412 = Conversion factor to Btu/hr from W, based on electric resistance heat $\frac{Btu/h}{W}$

13.0 = based on a 13.0 EER specified as the minimum efficiency for water-source heat pumps in ANSI/ASHRAE Standard 90.1-2016,

APPENDIX D. MRE AND COP WEIGHTED AVERAGE CALCULATIONS – INFORMATIVE

D1 Example Calculations. This appendix contains informative examples that help explain the procedures for calculating a weighted average MRE and COP if the Supply Air dew point temperature for dehumidification mode or the Supply Air dry bulb temperature for heating mode, respectively, cannot be controlled within the specified test condition tolerances. This appendix is not meant to replace requirements in Sections 6.9 and 6.11 for both MRE and COP, and illustrates the calculation MRE, and COP, ISMRE2, and IS COP2.

D2 MRE Weighted Average Examples. This Section provides examples of using the weighted average method to determine MRE values for cases in which the dew point temperature cannot be controlled within the specified test condition tolerance of the target value for any available compressor stage or variable load level.

D2.1 Example 1. Single Package DX-DOAS Unit with Cycle Reheat - Proportional Capacity Control: Lead Proportional Capacity Compressor, Lag Staged Capacity Compressor.

In this example, Standard Rating Condition C is tested twice at different steps of unloading since no available step of unloading can meet the Supply Air Dew Point Temperature of Standard Rating Condition A within +/- 0.3°F. Tested values used for performing the calculations are shown in Table D1 below.

Table D1. MRE Weighted Average Calculation Example 1; Tested Values													
Test #	Rating Condition	Staged Capacity Compressor (On/Off)	Proportional Capacity Compressor (30-100%)	Measured Supply Airflow (Q _{mSA}), cfm	Supply Airflow ³ (Q _{sA}), scfm	Measured Supply Air Dry Bulb Temperature (T _{SA,measured}), °F	Measured Supply Air Wet bulb Temperature, °F	Measured Humidity Ratio of Supply Air (W _{SA}), lb _{water} vapor/lb _{dry} air	Supply Air Dry Bulb Temperature ² (T _{sA}), °F	Supply Air Dew Point Temperature °F	Moisture Removal Capacity (MRC ¹), lb/h	Measured Total Power Input (P _T), W	Measured Moisture Removal Efficiency (MRE), lb/kWh
1	A	On	100%	2,049	2,000	75.0	61.0	0.008228	74.8	52.1	76.91	17,570	4.38
2	B	On	60%	2,049	2,008	73.0	60.4	0.00830	72.9	52.3	68.22	14,070	4.85
3	C	On	30%	2,049	2,029	68.0	57.4	0.007614	68.0	50.0	47.02	10,260	N/A
4	C	Off	100%	2,049	2,013	71.0	60.5	0.008829	71.0	54.0	35.67	8,340	N/A
5	D	Off	55%	2,049	2,038	65.0	57.3	0.008243	65.0	52.1	13.64	5,870	2.32

Notes:

1. Moisture Removal Capacities are calculated in accordance with Section 6.8.
2. The Supply Air dry bulb Temperature is adjusted for duct heat gain/loss in accordance with Section 6.1.4.
3. Supply Airflows in terms of Standard Air are calculated in accordance with Section 6.1.5.1.1.

D2.1.1 Calculation of MRE_x.

Test 1 at Standard Rating Condition A resulted in a Supply Air Dew Point Temperature of 52.1 °F, requiring all part load dehumidification test points to be tested and/or rated to a Supply Air Dew Point Temperature between 51.8 °F and 52.4 °F. Test 2 for Standard Rating Condition B and Test 5 for Standard Rating Condition D are within this range, thus the Moisture Removal Efficiencies can be calculated directly using the measurements for the single test conducted for each of these Standard Rating Conditions.

Due to compressor capacity control limitations, the DX-DOAS unit was unable to produce the required Supply Air Dew Point temperature at Standard Rating Condition C within the required tolerance. The target Dew Point was bracketed with tests at the nearest Supply Air Dew Point Temperatures above and below the required range based on the available compressor capacity control (tests 4 and 3, respectively). To determine the MRE rating for Standard Rating Condition C, the weighted averaging process described in Section 6.9.1 is used and demonstrated below.

D2.1.1.1 Calculate the Averaging Weights; weight a_{1,C} for Test 4 and a_{2,C} for Test 3.

$$a_{1,C} = \frac{W_{SA,A} - W_{SA,2}}{W_{SA,1} - W_{SA,2}} = \frac{0.008228 - 0.007614}{0.008829 - 0.007614} = 0.506$$

$$a_{2,C} = 1 - a_{1,C} = 1 - 0.505 = 0.494$$

D2.1.1.2 Calculate the Weighted Average Power Input ($P_{avg,C}$), W.

$$P_{avg,C} = a_{1,C} \cdot (P_{T,1,C} + P_{E,1,C} + W \text{ CoolPenalty}_{1,C}) + a_{2,C} \cdot (P_{T,2,C} + P_{E,2,C} + W \text{ CoolPenalty}_{2,C}) \\ = 0.506(8,340 + 0 + 0) + 0.494(10,260 + 0 + 0) = 9,288 \text{ W}$$

D2.1.1.3 Calculate the Weighted Average Moisture Removal Capacity ($MRC_{avg,C}$), lb/h.

$$MRC_{avg,C} = a_{1,C} \cdot MRC_{1,C} + a_{2,C} \cdot MRC_{2,C} = 0.506 \cdot 35.67 + 0.494 \cdot 47.02 = 41.27 \text{ lb/h}$$

D2.1.1.4 Calculate the Moisture Removal Efficiency (MRE_C), lb/kW·h.

$$MRE_C = \frac{1000 \cdot MRC_{avg,C}}{P_{avg,C}} = \frac{41.27 \text{ lb/h}}{9.288 \text{ kW}} = 4.44 \text{ lb/kW}\cdot\text{h}$$

D2.1.2 Calculation of $MRE_{70,x}$.

For the $MRE_{70,x}$ and $ISMRE_{270}$ rating conditions the Supplementary Heat required to provide a Supply Air dry bulb Temperature of 70 °F needs to be assessed for Tests 3 and 5. Section C6 describes the calculation of the Supplementary Heat penalty and the calculations for Example 1 are demonstrated below.

D2.1.2.1 Calculate the Specific Heat of Supply Air ($c_{p,SA}$), Btu/lb_{da}·°F.

D2.1.2.1.1 Test 3.

$$c_{p,SA} = 0.24 + 0.444 \cdot W_{SA} = 0.24 + 0.444 \cdot 0.007614 = 0.2434$$

D2.1.2.1.2 Test 5.

$$c_{p,SA} = 0.24 + 0.444 \cdot W_{SA} = 0.24 + 0.444 \cdot 0.008243 = 0.2437$$

D2.1.2.2 Calculate the Supplementary Heating Capacity Required ($q_{th,x}$), Btu/h

D2.1.2.2.1 Test 3.

$$q_{th,C(test3)} = 60 \cdot 0.075 \cdot Q_{SA} \cdot c_{p,SA} (70^\circ\text{F} - T_{SA}) \\ = 60 \cdot 0.075 \cdot 2029 \cdot 0.2434 \cdot (70 - 68) = 4,444 \frac{\text{Btu}}{\text{h}}$$

D2.1.2.2.2 Test 5.

$$q_{th,C(test5)} = 60 \cdot 0.075 \cdot Q_{SA} \cdot c_{p,SA} (70^\circ\text{F} - T_{SA}) \\ = 60 \cdot 0.075 \cdot 2038 \cdot 0.2437 \cdot (70 - 65) = 11,177 \frac{\text{Btu}}{\text{h}}$$

D2.1.2.3 Calculate the Supplementary Heat Penalty, ($W \text{ HeatPenalty}$), W.

D2.1.2.3.1 Test 3.

$$W \text{ HeatPenalty}_{C(test3)} = \frac{q_{th,C(test3)}}{3.412} = \frac{4,444}{3.412} = 1,303 \text{ W}$$

D2.1.2.3.2 Test 5.

$$W \text{ HeatPenalty}_{D(test5)} = \frac{q_{th,D(test5)}}{3.412} = \frac{11,177}{3.412} = 3,276 \text{ W}$$

Note: The averaging weights and weighted average Moisture Removal Capacity from the MRE_C calculation above remain the same for the $MRE_{70,C}$ calculation. However, the Weighted Average Power needs to be recalculated to account for the Supplementary Heat Penalty.

D2.1.2.4 Calculate the Weighted Average Power Input, ($P_{70,avg,C}$), W.

$$P_{70,avg,C} = a_{1,C} \cdot (+ W CoolPenalty_{1,C} + W HeatPenalty_{1,C}) + a_{2,C} \cdot (P_{T,2,C} + P_{E,2,C} + W CoolPenalty_{2,C} + W HeatPenalty_{2,C})$$

$$P_{70,avg,C} = 0.506 \cdot (8,340 + 0 + 0 + 0) + 0.494 \cdot (10,260 + 0 + 0 + 1,303) = 9,932 \text{ W}$$

D2.1.2.5 Calculate the Moisture Removal Efficiency-70 at Condition C, ($MRE_{70,C}$), lb/kW-h.

$$MRE_{70,C} = \frac{1000 \frac{W}{kW} \cdot MRC_{avg,C}}{P_{70,avg,C}} = \frac{1000 \frac{W}{kW} \cdot 41.27 \text{ lb/h}}{9.932 \text{ W}} = 4.15 \text{ lb/kW}\cdot\text{h}$$

D2.1.2.6 Calculate the Moisture Removal Efficiency-70 at Condition D, ($MRE_{70,D}$), lb/kW-h.

$$MRE_{70,D} = \frac{1000 \frac{W}{kW} \cdot MRC_D}{P_{T,D} + P_{E,D} + W CoolPenalty_D + W HeatPenalty_D}$$

$$MRE_{70,D} = \frac{1000 \frac{W}{kW} \cdot 13.64 \text{ lb/h}}{(5.870 + 0 + 0 + 3,276) \cdot W} = 1.49 \frac{\text{lb}}{\text{kW}\cdot\text{h}}$$

D2.1.3 Calculation of $ISMRE2$ and $ISMRE_{270}$.

The values shown Sections D2.1.3.1 and D2.1.3.2 are calculated using Equations 40 and 41 in Section 6.13.

D2.1.3.1 Calculate $ISMRE2$, lb/kW-h.

$$ISMRE2 = (MRE_A \cdot 0.14) + (MRE_B \cdot 0.34) + (MRE_C \cdot 0.39) + (MRE_D \cdot 0.13)$$

$$ISMRE2 = (4.38 \cdot 0.14) + (4.85 \cdot 0.34) + (4.44 \cdot 0.39) + (2.32 \cdot 0.13) = 4.3 \text{ lb/kWh}$$

D2.1.3.2 Calculate $ISMRE_{270}$, lb/kW-h.

$$ISMRE_{270} = (MRE_{70,A} \cdot 0.14) + (MRE_{70,B} \cdot 0.34) + (MRE_{70,C} \cdot 0.39) + (MRE_{70,D} \cdot 0.13)$$

$$ISMRE_{270} = (4.38 \cdot 0.14) + (4.85 \cdot 0.34) + (4.15 \cdot 0.39) + (1.49 \cdot 0.13) = 4.1 \text{ lb/kWh}$$

D2.2 Example 2. Single Package DX-DOAS Unit with Refrigerant Reheat - Staged Capacity Control: lead/lag Staged compressors.

In this example, Standard Rating Condition B is tested twice at different steps of unloading since no available step of unloading could meet the Supply Air dew point temperature of Rating Condition A within +/- 0.3°F. Additionally at Rating Condition D the DX-DOAS unit over-dehumidified the Supply Air to a Supply Air Dew Point below Standard Rating Condition A and is adjusted to account for cyclic degradation. Tested values used for performing the calculations are shown in Table D2 below.

Table D2 – MRE Weighted Average Calculation Example 2; Tested Values

Test #	Rating Condition	Lead Staged Capacity Compressor (On/Off)	Lag Staged Capacity Compressor (On/Off)	Measured Supply Airflow (Q _{mSA}), cfm	Supply Airflow ³ (QSA), scfm	Measured Supply Air Dry Bulb Temperature (TSA _{measured}), °F	Measured Supply Air Wet bulb Temperature, °F	Measured Humidity Ratio of Supply Air (WSA), lb _{water vapor} /lb _{dry air}	Supply Air Dry Bulb Temperature ² (TSA), °F	Supply Air Dew Point Temperature, °F	Moisture Removal Capacity (MRC) ¹ , lb/h	Measured Total Power Input (PT), W	Measured Moisture Removal Efficiency (MRE _x), lb/kWh
1	A	On	On	2,049	2,000	75.0	61.0	0.008229	74.8	52.1	76.91	17,640	4.36
2	B	On	On	2,049	2,031	68.0	56.0	0.006800	67.9	47.0	82.84	16,360	N/A
3	B	On	Off	2,049	1,998	73.0	65.0	0.011357	72.9	60.8	40.43	9,420	N/A
4	C	On	Off	2,049	2,023	69.0	58.7	0.008171	69.0	51.9	41.85	9,500	4.40
5	D	On	Off	2,049	2,032	67.0	57.2	0.007729	67.0	50.4	18.32	6,640	N/A

Notes:

1. Moisture Removal Capacity is calculated in accordance with Section 6.9
2. The supply air dry bulb temperature is adjusted for duct heat gain/loss in accordance with Section 6.1.4.3
3. Supply Airflows in terms of Standard Air are calculated in accordance with Section 6.1.5.1.1.

D2.2.1 Calculation of MRE_x

Test 1 at Standard Rating Condition A resulted in a Supply Air Dew Point Temperature of 52.1 °F requiring all part load dehumidification test points to be tested and/or rated to a Supply Air Dew Point Temperature between 51.8 °F and 52.4 °F. Test 2 for Standard Rating Condition C was within the allotted tolerances and the as tested Moisture Removal Efficiencies can be used for Conditions A and C.

Due to stage compressor capacity control limitations, the DX-DOAS unit was unable to produce the required Supply Air Dew Point Temperature at Standard Rating Condition B and was bracketed with tests at the nearest Supply Air Dew Point Temperatures above and below the required range based on the available compressor capacity control. Tests 3 and 2 represent these tests, respectively. To determine the MRE rating for Standard Rating Condition B the weighted averaging process described in 6.9.1 is used and demonstrated below.

D2.2.1.1 Calculate the Averaging Weights; Weight a_{1,B} for Test 3 and a_{2,B} for Test 4

$$a_{1,B} = \frac{W_{SA,A} - W_{SA,2}}{W_{SA,1} - W_{SA,2}} = \frac{0.008229 - 0.006800}{0.011357 - 0.006800} = 0.313$$

$$a_{2,B} = 1 - a_{1,B} = 1 - 0.313 = 0.687$$

D2.2.1.2 Calculate the Weighted Average Power Input, (P_{avg,B}), W.

$$P_{avg,B} = a_{1,B} \cdot (P_{T,1,B} + P_{E,1,B} + W \text{ CoolPenalty}_{1,B}) + a_{2,B} \cdot (P_{T,2,B} + P_{E,2,B} + W \text{ CoolPenalty}_{2,B})$$

$$P_{avg,B} = 0.313 \cdot (9,420 + 0 + 0) + 0.687 \cdot (16,360 + 0 + 0) = 14,188 \text{ W}$$

D2.2.1.3 Calculate the Weighted Average Moisture Removal Capacity, (MRC_{avg,B}), lb/h.

$$MRC_{avg,B} = a_{1,B} \cdot MRC_{1,B} + a_{2,B} \cdot MRC_{2,B} = 0.313 \cdot 40.43 + 0.687 \cdot 82.84 = 69.57 \text{ lb/h}$$

D2.2.1.4 Calculate the Moisture Removal Efficiency at Standard Rating Condition B, (MRE_B), lb/kW-h.

$$MRE_B = \frac{1000 \frac{W}{kW} \cdot MRC_{avg,B}}{P_{avg,B}} = \frac{1000 \frac{W}{kW} \cdot 69.57 \text{ lb/h}}{14,188 \text{ W}} = 4.9 \text{ lb/kW-h}$$

Note: The results from Condition D need to be adjusted for cyclic degradation using the calculations of 6.8.2.

D2.2.1.5 Calculate the Target Moisture Removal Capacity, ($MRC_{Tg,D}$), lb/h.

$$MRC_{Tg,D} = 60 \cdot 0.075 \cdot Q_{SA,D} \cdot (W_{OA,D} - W_{SA,A})$$

$$MRC_{Tg,D} = 60 \cdot 0.075 \cdot 2032 \cdot (0.009729 - 0.008229) = 13.7 \text{ lb/hr}$$

D2.2.1.6 Calculate the Load Factor (LF)

$$LF_D = \frac{(W_{OA,x} - W_{SA,A})}{(W_{OA,x} - W_{SA,Low})} = \frac{0.009729 - 0.008229}{0.009729 - 0.007729} = 0.748$$

D2.2.1.7 Calculate the Coefficient of Degradation ($C_{D,D}$)

$$C_{D,D} = 1 + 0.35 \cdot (1 - LF_D) = 1 + 0.35 \cdot (1 - 0.748) = 1.088$$

D2.2.1.8 Calculate the Moisture Removal Efficiency, (MRE_D), lb/kW-h.

Given that $P_{NC,D} = 1,851 \text{ W}$, $P_{CC,D} = 4,794 \text{ W}$,

$$MRE_D = \frac{MRC_{TgD}}{LF_D \cdot C_{D,D} \cdot (P_{CC,D} + W \text{ CoolPenalty}_D) + P_{NC,D}}$$

$$MRE_D = \frac{1000 \frac{\text{W}}{\text{kW}} \cdot 13.7 \text{ lb/h}}{0.748 \cdot 1.088 \cdot (4,794 + 0)\text{W} + 1,851\text{W}} = 2.38 \frac{\text{lb}}{\text{kW} \cdot \text{h}}$$

D2.2.2 Calculation of $MRE_{70,x}$. For the $MRE_{70,x}$ and $ISMRE_{270}$ rating conditions, the Supplementary Heat Penalty to provide a Supply Air dry bulb Temperature of 70 °F needs to be calculated for Tests 2, 4 and 5. Section C6 describes the calculation of the Supplementary Heat penalty and the calculations for Example 2 are demonstrated below.

D2.2.2.1 Calculate the Specific Heat of Supply Air, ($c_{p,SA}$), Btu/lb_{da}°F.

D2.2.2.1.1 Test 2.

$$c_{p,SA} = 0.24 + 0.444 \cdot W_{SA} = 0.24 + 0.444 \cdot 0.006800 = 0.2430$$

D2.2.2.1.2 Test 4.

$$c_{p,SA} = 0.24 + 0.444 \cdot W_{SA} = 0.24 + 0.444 \cdot 0.008171 = 0.2436$$

D2.2.2.1.3 Test 5.

$$c_{p,SA} = 0.24 + 0.444 \cdot W_{SA} = 0.24 + 0.444 \cdot 0.007729 = 0.2434$$

D2.2.2.2 Calculate the Supplementary Heating Capacity Required, ($q_{th,x}$), Btu/h

D2.2.2.2.1 Test 2.

$$q_{th,B(test2)} = 60 \cdot 0.075 \cdot Q_{SA} \cdot c_{p,SA} \cdot (70^\circ\text{F} - T_{SA})$$

$$q_{th,B(test2)} = 60 \cdot 0.075 \cdot 2031 \cdot 0.2430 \cdot (70 - 67.9)^\circ\text{F} = 4,665 \frac{\text{Btu}}{\text{h}}$$

D2.2.2.2.2 Test 4.

$$q_{th,C(test4)} = 60 \cdot 0.075 \cdot Q_{SA} \cdot c_{p,SA} \cdot (70^\circ\text{F} - T_{SA})$$

$$q_{th,C(test4)} = 60 \cdot 0.075 \cdot 2023 \cdot 0.2436 \cdot (70 - 69) = 2,218 \frac{\text{Btu}}{\text{h}}$$

D2.2.2.2.3 Test 5.

$$q_{th,D(test5)} = 60 \cdot 0.075 \cdot Q_{SA} \cdot c_{p,SA} \cdot (70^\circ\text{F} - T_{SA})$$

$$q_{th,D(test5)} = 60 \cdot 0.075 \cdot 2032 \cdot 0.2434 \cdot (70 - 67) = 6,679 \frac{\text{Btu}}{\text{h}}$$

D2.2.2.3 Calculate the Supplementary Heat Penalty, (W HeatPenalty), W.

D2.2.2.3.1 Test 2.

$$W \text{ HeatPenalty}_{B(test2)} = \frac{q_{th,B(test2)}}{3.412} = \frac{4,665}{3.412} = 1,367 \text{ W}$$

D2.2.2.3.2 Test 4.

$$W \text{ HeatPenalty}_{C(test4)} = \frac{q_{th,C(test4)}}{3.412} = \frac{2,218}{3.412} = 650 \text{ W}$$

D2.2.2.3.3 Test 5.

$$W \text{ HeatPenalty}_{D(test5)} = \frac{q_{th,D(test5)}}{3.412} = \frac{6,679}{3.412} = 1,957 \text{ W}$$

D2.2.2.4 Calculate the Weighted Average Power Input, $P_{70,avg,B}$ (W)

$$P_{70,avg,B} = a_{1,B} \cdot (P_{T,1,B} + P_{E,1,B} + W \text{ CoolPenalty}_{1,B} + W \text{ HeatPenalty}_{1,B}) + a_{2,B} \cdot (P_{T,2,B} + P_{E,2,B} + W \text{ CoolPenalty}_{2,B} + W \text{ HeatPenalty}_{2,B})$$

$$P_{70,avg,B} = 0.313 \cdot (9,420 + 0 + 0 + 0) \text{ W} + 0.687 \cdot (16,360 + 0 + 0 + 1,367) \text{ W} = 15,127 \text{ W}$$

D2.2.2.5 Calculate the Moisture Removal Efficiency, (MRE_B), lb/kW-h.

$$MRE_{70,B} = \frac{1000 \cdot MRC_{avg,B}}{P_{70,avg,B}} = \frac{1000 \frac{\text{W}}{\text{kW}} \cdot 69.57 \text{ lb/h}}{15,127 \text{ W}} = 4.60 \text{ lb/kWh}$$

D2.2.2.6 Calculate the Moisture Removal Efficiency-70, ($MRE_{70,C}$), lb/kW-h.

$$MRE_{70,C} = \frac{1000 \frac{\text{W}}{\text{kW}} \cdot MRC_C}{(P_{T,C} + P_{E,C}) + W \text{ CoolPenalty}_C + W \text{ HeatPenalty}_C}$$

$$MRE_{70,C} = \frac{1000 \frac{\text{W}}{\text{kW}} \cdot 41.85 \frac{\text{lb}}{\text{h}}}{(9.500 + 0) \text{ W} + 0 \text{ W} + 0.650 \text{ W}} = 4.12 \frac{\text{lb}}{\text{kW} \cdot \text{h}}$$

Note: The results from Condition D need to be adjusted to account for cyclic degradation using calculations found in Section 6.9.2. The Target MRC, Load Factor and Coefficient of Degradation remain unchanged from the $MRE_{70,D}$ calculation.

D2.2.2.7 Calculate the Moisture Removal Efficiency-70, ($MRE_{70,D}$), lb/kW-h.

Given that $P_{NC,D} = 1,851 \text{ W}$, $P_{CC,D} = 4,794 \text{ W}$ and $W \text{ HeatPenalty}_D = 1,957 \text{ W}$,

$$MRE_{70,D} = \frac{1000 \frac{\text{W}}{\text{kW}} \cdot MRC_{Tg,D}}{LF_D \cdot C_{D,D} \cdot (P_{CC,D} + W \text{ CoolPenalty}_D + W \text{ HeatPenalty}_D) + P_{NC,D}}$$

$$MRE_{70,D} = \frac{1000 \frac{W}{kW} \cdot 13.70 \frac{lb}{h}}{0.748 \cdot 1.088 \cdot (4,794 + 1,957)W + 1,851W} = 1.87 \frac{lb}{kW \cdot h}$$

D2.2.3 Calculation of ISMRE2 and ISMRE270.

Values in this section are calculated using equations 34 and 35 in Section 6.13.

D2.2.3.1 Calculate ISMRE2, lb/kW-h.

$$ISMRE2 = (MRE_A \cdot 0.14) + (MRE_B \cdot 0.34) + (MRE_C \cdot 0.39) + (MRE_D \cdot 0.13)$$

$$ISMRE2 = (4.36 \cdot 0.14) + (4.90 \cdot 0.34) + (4.40 \cdot 0.39) + (2.38 \cdot 0.13) = 4.3 \text{ lb/kWh}$$

D2.2.3.2 Calculate ISMRE270, lb/kW-h.

$$ISMRE_{270} = (MRE_{70,A} \cdot 0.14) + (MRE_{70,B} \cdot 0.34) + (MRE_{70,C} \cdot 0.39) + (MRE_{70,D} \cdot 0.13)$$

$$ISMRE_{270} = (4.36 \cdot 0.14) + (4.60 \cdot 0.34) + (4.12 \cdot 0.39) + (1.87 \cdot 0.13) = 4.0 \text{ lb/kWh}$$

D3. COP_{ISCOPE,x} Weighted Average Calculation Examples. This Section provides examples of using the weighted average method to calculate COP_{ISCOPE,x} values in the case that no permanent step of unloading can meet a Supply Air dry bulb temperature of 70-75 °F.

D3.1. Example 1. Single Package DX-DOAS unit with Refrigerant Reheat - Proportional Capacity Control: lead variable capacity compressor, lag staged compressor

In this example Standard Rating condition F is tested twice since a Supply Air dry bulb temperature of 70-75 °F cannot be obtained with the available compressor capacity control and requires using the weighted average method to calculate COP.

Table D3 - COP Weighted Average Calculation Example 1; Tested Values

Test #	Rating Condition	Staged Capacity Compressor (On/Off)	Proportional Capacity Compressor (30-100%)	Measured Supply Airflow (Q _{mSA}), cfm	Supply Airflow ¹ (Q _{SA}), scfm	Measured Supply Air Dry bulb Temperature (T _{SA,measured}), °F	Measured Supply Air Wet bulb Temperature, °F	Measured Humidity Ratio of Supply Air (W _{SA}), lb _{water vapor} /lb _{dry air}	Supply Air Dry bulb Temperature ² (T _{SA}), °F	Liquid Flow Rate (WF), gpm	Water Pressure Drop, (ΔP), psi	Heating Capacity ³ (q _{hp}), Btu/h	Measured Total Power Input (PT), W	Measured Coefficient of Performance (COP), W/W
1	E	Off	55%	3,200	3,153	72.8	54.6	0.004912	73.1	60	5.01	89,697	7,975	2.61
2	F	Off	100%	3,200	3,211	66.4	44.5	0.001256	66.9	60	5.01	173,424	12,220	N/A
3	F	On	30%	3,200	3,041	95.7	57.2	0.001243	96.5	60	5.01	261,719	14,704	N/A

Notes:

1. Supply Airflows in terms of Standard Air are calculated in accordance with Section 6.1.5.1.1
2. The Supply Air dry bulb temperature is adjusted for duct heat gain/loss in accordance with Section 6.1.4.
3. Measured Heating Capacities are calculated in accordance with Section 6.10.

D3.1.1 Calculation of Pumping Effect, (P_{E,x}), W

Before the COP values can be determined, the Water Pump Effect needs to be calculated using the measured Liquid Flow Rate and measured Water Pressure Drop. For this example, the pumping effect is the same for all tested conditions and is calculated using equation 3 in Section 6.1.6.4.

$$P_{E,E} = P_{E,F} = WF \cdot [(PP_B \cdot \Delta P) + C] = 60 \cdot [(2.02 \cdot 5.01) + 25] = 2,107 \text{ W}$$

D3.1.2 Calculation of COP_{ISCOPE,x}

D3.1.2.1 Calculate the Coefficient of Performance, (COP_{ISCOPE,E}), W/W

$$COP_{ISCOP,E} = \frac{\left(\frac{q_{hp,ISCOP,E}}{3.412}\right)}{P_{T,E} + P_{E,E} + W \text{ HeatPenalty}}$$

$$COP_{ISCOP,E} = \frac{\left(\frac{89,697}{3.412}\right)}{7,975 + 2,107 + 0} = 2.61 \text{ W/W}$$

D3.1.2.2 Calculate the Averaging Weights for Condition F for Tests 2 ($a_{1,F}$) and 3 ($a_{2,F}$)

$$a_{1,F} = \frac{t_{SA,2,F} - 75 \text{ }^\circ\text{F}}{t_{SA,2,F} - t_{SA,1,F}} = \frac{96.5 - 75}{96.5 - 66.9} = 0.726$$

$$a_{2,F} = 1 - a_{1,F} = 1 - 0.726 = 0.274$$

D3.1.2.3 Calculate the Weighted Average Power for Condition F, ($P_{avg,F}$), W. When using the weighted average method, the power calculation does not include a supplementary heating penalty, even though the supply air temperature was lower than 21 °C for one of the two tests.

$$P_{avg,F} = a_{1,F} \cdot (P_{T,1,F} + P_{E,1,F}) + a_{2,F} \cdot (P_{T,2,F} + P_{E,2,F})$$

$$P_{avg,F} = 0.726 \cdot (12,220 + 2,107) + 0.274 \cdot (14,704 + 2,107) = 15,007 \text{ W}$$

D3.1.2.4 Calculate the Weighted Average Heating Capacity for Condition F, ($q_{hp, avg,ISCOP,F}$), Btu/h.

$$q_{hp,avg,ISCOP,F} = a_{1,F} \cdot q_{hp,1,ISCOP,F} + a_{2,x} \cdot q_{hp,2,ISCOP,F}$$

$$q_{hp,avg,ISCOP,F} = 0.726 \cdot 173,424 + 0.274 \cdot 261,719 = 197,586 \text{ Btu/h}$$

D3.1.2.5 Calculate the Coefficient of Performance, ($COP_{ISCOP,F}$), W/W

$$COP_{ISCOP,F} = \frac{\left(\frac{q_{hp,avg,ISCOP,F}}{3.412}\right)}{P_{avg,F}} = \frac{\left(\frac{197,586}{3.412}\right)}{15,007} = 3.86 \text{ W/W}$$

D3.1.3 Calculation of IS COP2, W/W

$$ISCOP2 = (COP_{ISCOP,E} \cdot 0.91) + (COP_{ISCOP,F} \cdot 0.09) = (2.61 \cdot 0.91) + (3.86 \cdot 0.09) = 2.72$$

D3.2 Example 2. Single Package DX-DOAS unit with Refrigerant Reheat – Staged Capacity Control: lead/lag staged compressors

In this example Standard Rating Condition F is tested twice since a Supply Air dry bulb Temperature of 75 °F cannot be obtained with the available compressor capacities and requires a weighted average $COP_{ISCOP,F}$. Additionally, the heating capacity for Test 1 must be adjusted since the measured Supply Air dry bulb Temperature was greater than the allowed Supply Air Dry bulb Temperature range (70-75 °F) when operating using the lowest-capacity stage.

Table D4 - COP Weighted Average Calculation Example 2; Tested Values

Test #	Rating Condition	Staged Capacity Compressor (On/Off)	Staged Capacity Compressor (On/Off)	Measured Supply Airflow (Q _{SA}), cfm	Supply Airflow ¹ (Q _{SA}), scfm	Measured Supply Air Dry Bulb Temperature (T _{SA,measured}), °F	Measured Supply Air Wet bulb Temperature °F	Measured Humidity Ratio of Supply Air (W _{SA}), lb _{water vapor} /lb _{dry air}	Supply Air Dry bulb Temperature ² (T _{SA}), °F	Liquid Flow Rate (WF), gpm	Water Pressure Drop, (ΔP), psi	Heating Capacity ³ (q _{hp}), Btu/h	Measured Total Power Input (PT), W	Measured Coefficient of Performance (COP), W/W
1	E	On	Off	3,200	3,020	96.3	63.4	0.004948	96.8	60	5.01	92,160	14,563	1.62
2	F	On	Off	3,200	3,211	66.4	44.5	0.001256	66.9	60	5.01	201,604	12,220	N/A
3	F	On	On	3,200	2,897	123.3	66.9	0.001285	124.4	60	5.01	181,902	23,179	N/A

Notes:

1. Supply Airflows in terms of Standard Air are calculated in accordance with Section 6.1.5.1.1
2. The Supply Air dry bulb temperature is adjusted for duct heat gain/loss in accordance with Section 6.1.4.
3. Measured Heating Capacities are calculated in accordance with Section 6.10.

D3.2.1 Calculation of Pumping Effect, (P_{E,x}), W. Before the COP values can be determined, the Water Pump Effect needs to be calculated using the measured Liquid Flow Rate and measured Water Pressure Drop, the Water Pump Effect. For this example, the pumping effect is the same for all tested conditions and is calculated using equation 3 in Section 6.1.6.4.

$$P_{E,E} = P_{E,F} = WF \cdot [(PP_B \cdot \Delta P) + C] = 60 \cdot [(2.02 \cdot 5.01) + 25] = 2,107 W$$

D3.2.2 Calculation of COP_{ISCOPE,x}. To determine COP_{ISCOPE}, the heating capacity needs to be de-rated to a supply air temperature of 75 °F according to Section 6.1.6.4 and Table 11.

D3.2.2.2 Calculate the Specific Heat of Supply Air for Condition E, (c_{pSA}), Btu/lb_{da}·°F

$$c_{pSA} = 0.24 + 0.444W_{SA} = 0.24 + 0.444 \cdot 0.004948 = 0.2422$$

D3.2.2.3 Calculate the Heating Capacity for Condition E, (q_{hp,ISCOPE,E}), Btu/h

$$q_{hp,ISCOPE,E} = 60 \cdot 0.075 \cdot Q_{SA} \cdot c_{pSA} \cdot (75 \text{ °F} - T_{OA})$$

$$q_{hp,ISCOPE,E} = 60 \cdot 0.075 \cdot 3,020 \cdot 0.2422 \cdot (75 - 47) = 92,160 \text{ Btu/h}$$

D3.2.2.4 Calculate the Coefficient of Performance, (COP_{ISCOPE,E}), W/W

$$COP_{ISCOPE,E} = \frac{\left(\frac{q_{hp,ISCOPE,E}}{3.412}\right)}{P_{T,E} + P_{E,E} + W \text{ HeatPenalty}_E} = \frac{\left(\frac{92,160}{3.412}\right)}{14,563 + 2,107 + 0} = 1.62$$

D3.2.2.5 Calculate the Averaging Weights for Condition F for Tests 2 (a_{1,F}) and 3 (a_{2,F})

$$a_{1,F} = \frac{t_{SA,2,F} - 75 \text{ °F}}{t_{SA,2,F} - t_{SA,1,F}} = \frac{124.4 - 75}{124.4 - 66.9} = 0.859$$

$$a_{2,F} = 1 - a_{1,F} = 1 - 0.859 = 0.141$$

D3.2.2.6 Calculate the Weighted Average Power for Condition F, (P_{avg,F}), W.

$$P_{avg,F} = a_{1,F} \cdot (P_{T,1,F} + P_{E,1,F}) + a_{2,F} \cdot (P_{T,2,F} + P_{E,2,F})$$

$$P_{avg,F} = 0.859 \cdot (12,220 + 2,107) + 0.141 \cdot (23,179 + 2,107) = 15,871 W$$

D3.2.2.7 Calculate the Weighted Average Heating Capacity for Condition F, (q_{hp,avg,ISCOPE,F}), Btu/h.

$$q_{hp,avg,ISCOP,F} = a_{1,F} \cdot q_{hp,1,ISCOP,F} + a_{2,x} \cdot q_{hp,2,ISCOP,F}$$

$$q_{hp,avg,ISCOP,F} = 0.859 \cdot 173,424 + 0.141 \cdot 336,424 = 196,443 \text{ Btu/h}$$

D3.2.2.8 Calculate the Coefficient of Performance, ($COP_{ISCOP,F}$), W/W

$$COP_{ISCOP,F} = \frac{\left(\frac{q_{hp,ISCOP,F}}{3.412}\right)}{P_{avg,F}} = \frac{\left(\frac{196,443}{3.412}\right)}{15,871} = 3.63 \text{ W/W}$$

D3.2.3 Calculation of $ISCOP2$, W/W

$$ISCOP2 = (COP_{ISCOP,E} \cdot 0.91) + (COP_{ISCOP,F} \cdot 0.09)$$

$$ISCOP2 = (1.62 \cdot 0.91) + (3.67 \cdot 0.09) = 1.80$$

APPENDIX E. TYPICAL TEST UNIT INSTALLATIONS - INFORMATIVE

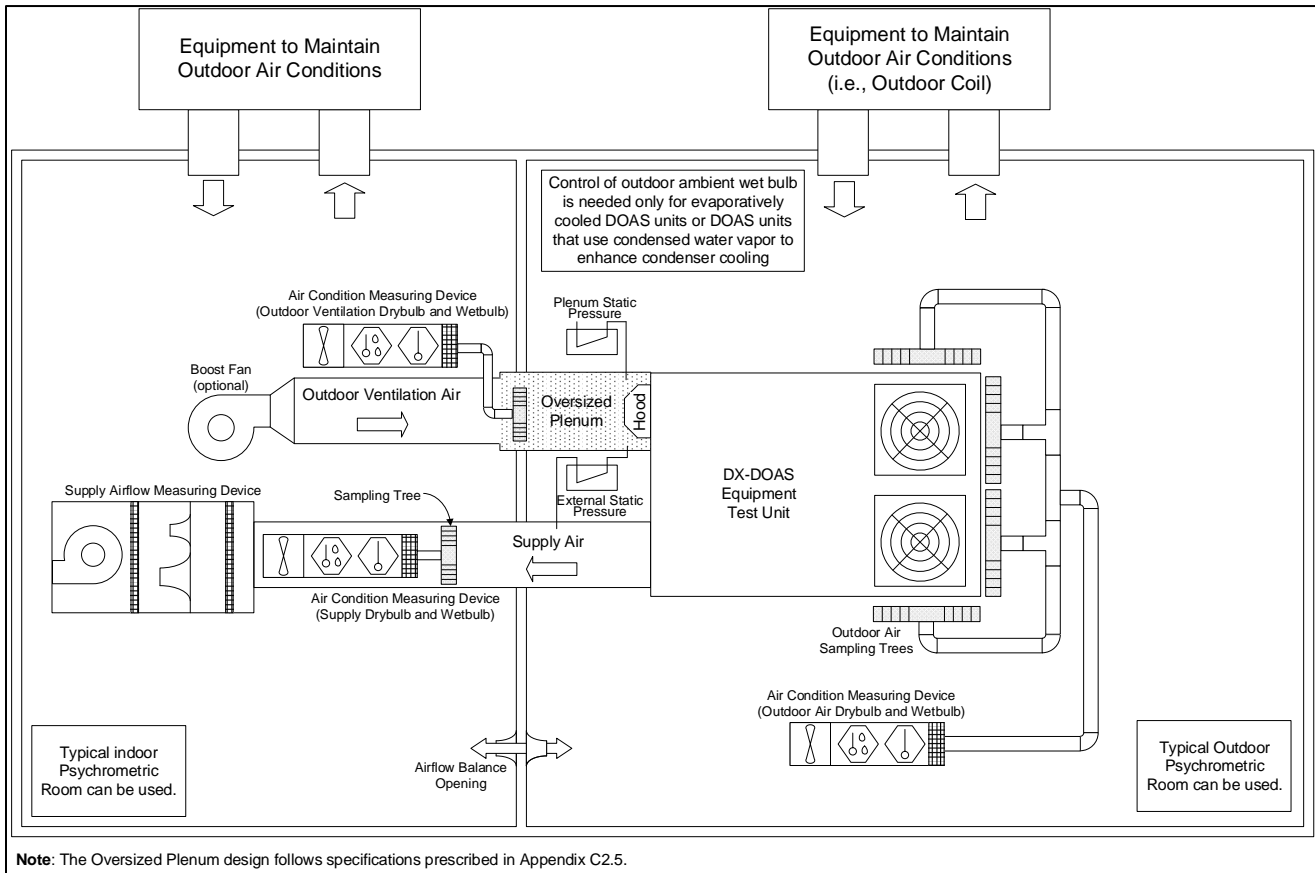

Figure E1. Single Package DX-DOAS laboratory schematic (No VERS)

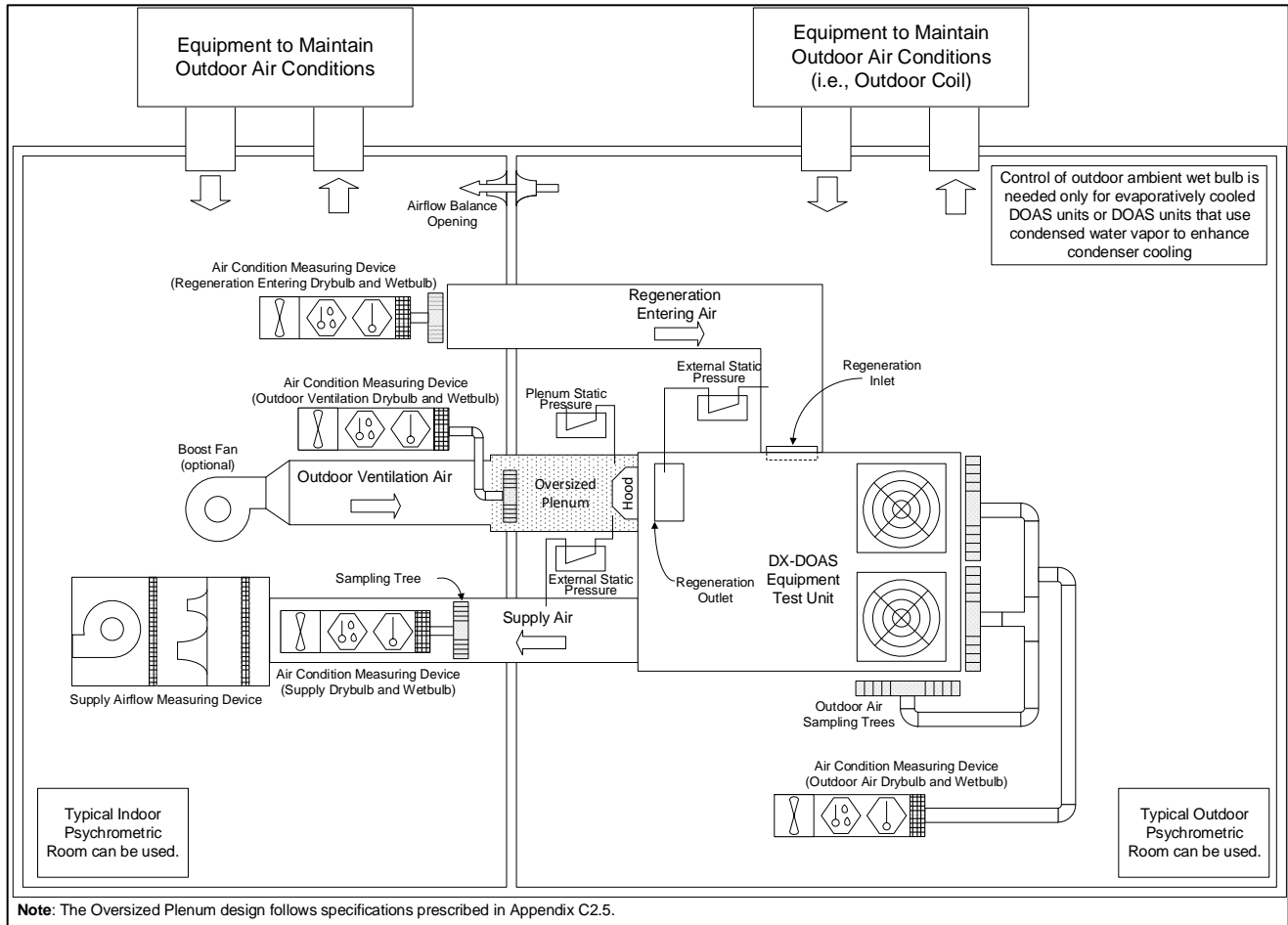

Figure E2. Single Package DX-DOAS with desiccant wheel laboratory schematic (No VERS)

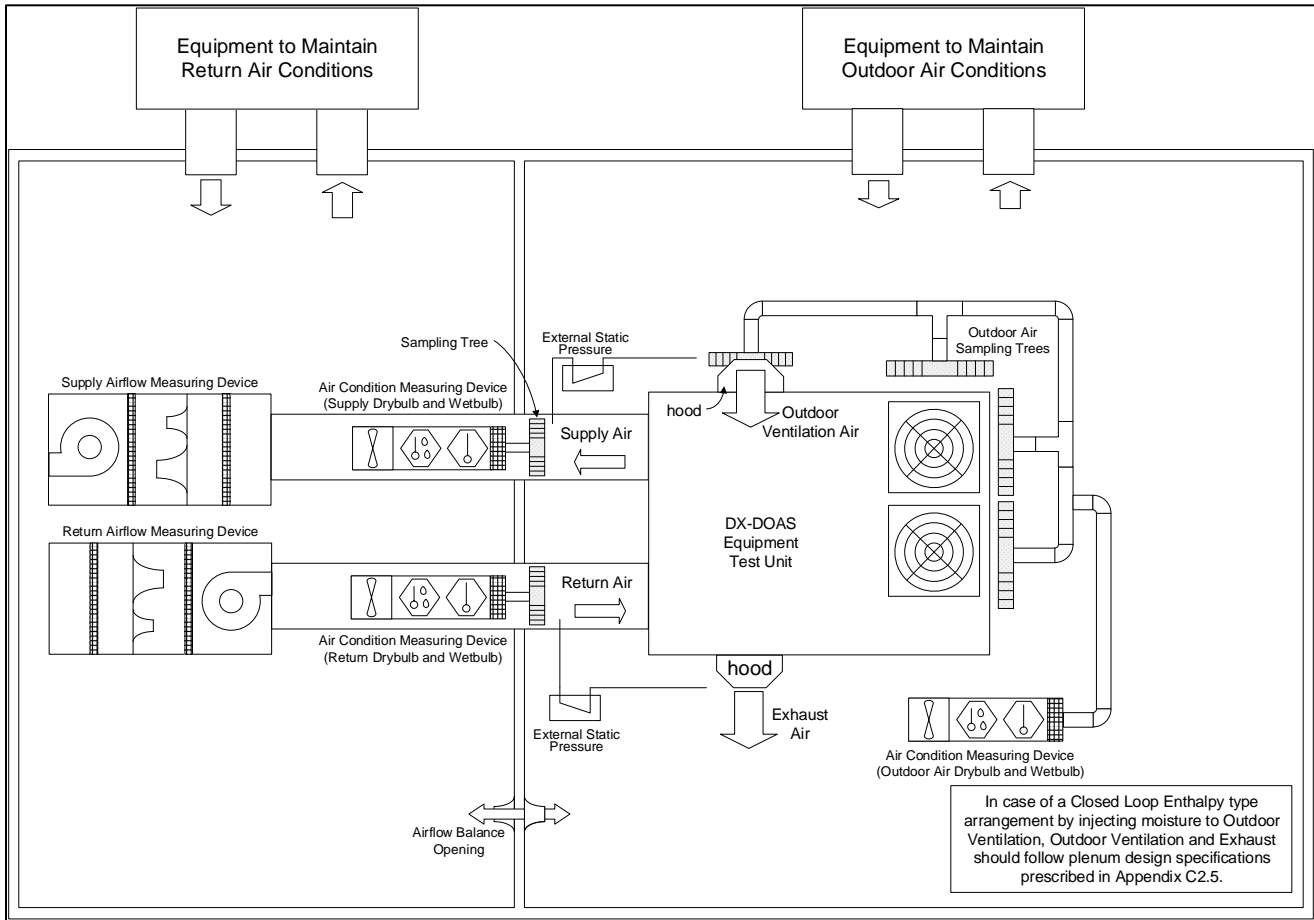

Figure E3. Single Package DX-DOAS unit with VERS (Option 1 – 2 Rooms)

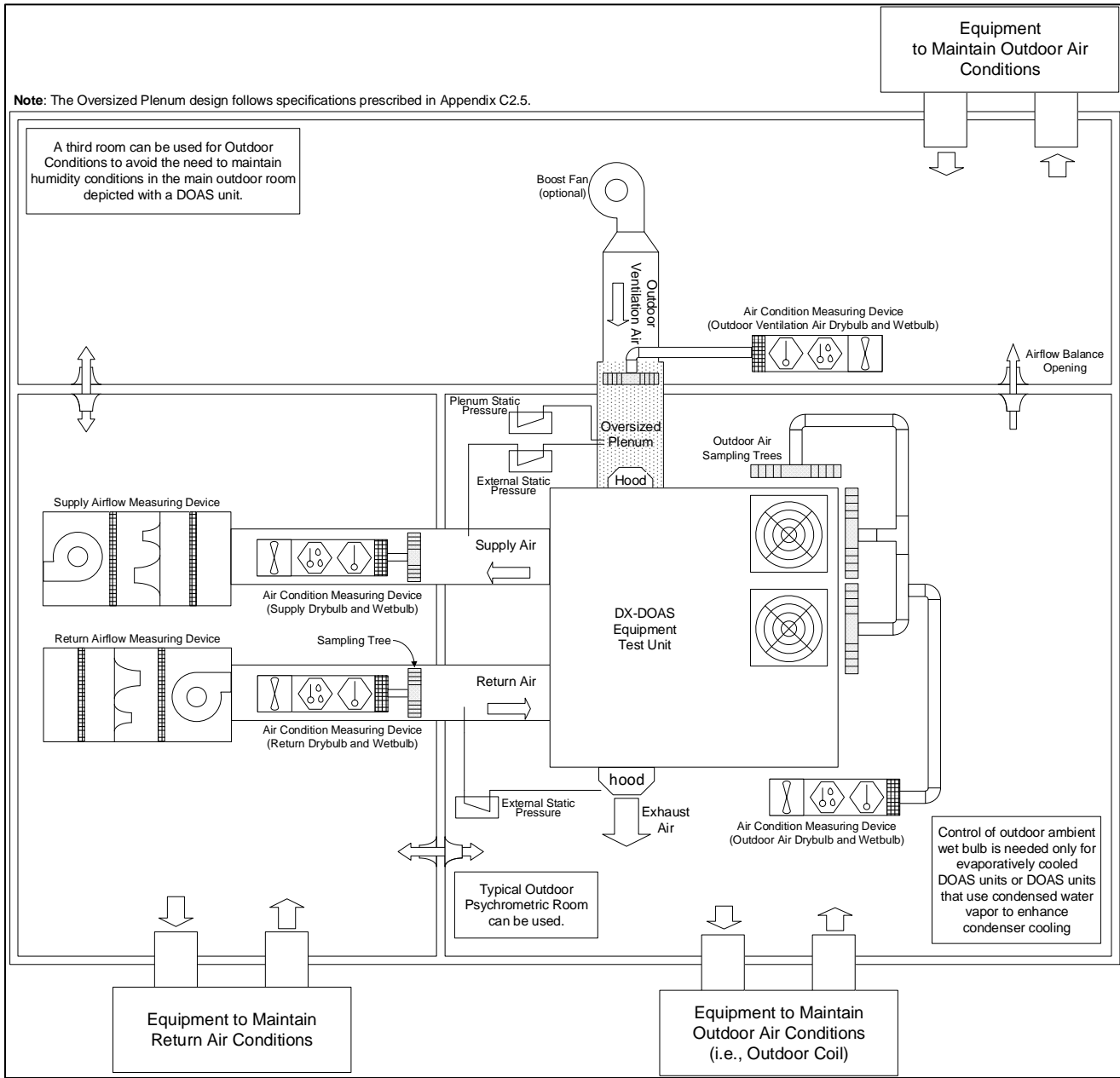

Figure E4. Single Package DX-DOAS unit with VERS (Option 1 – 3 Rooms)

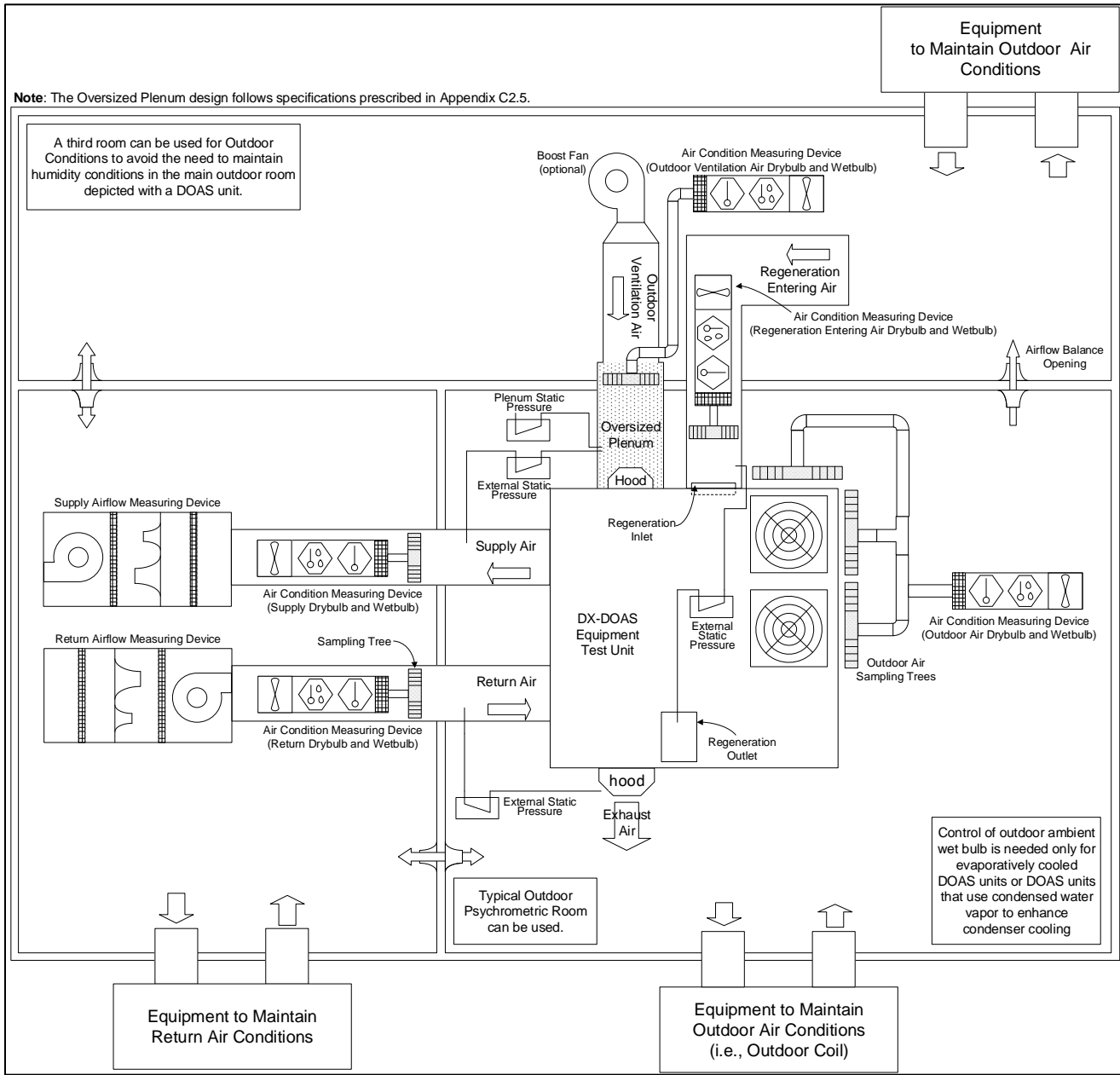

Figure E5. Single Package DX-DOAS with desiccant wheel (Option 1 – 3 Rooms)

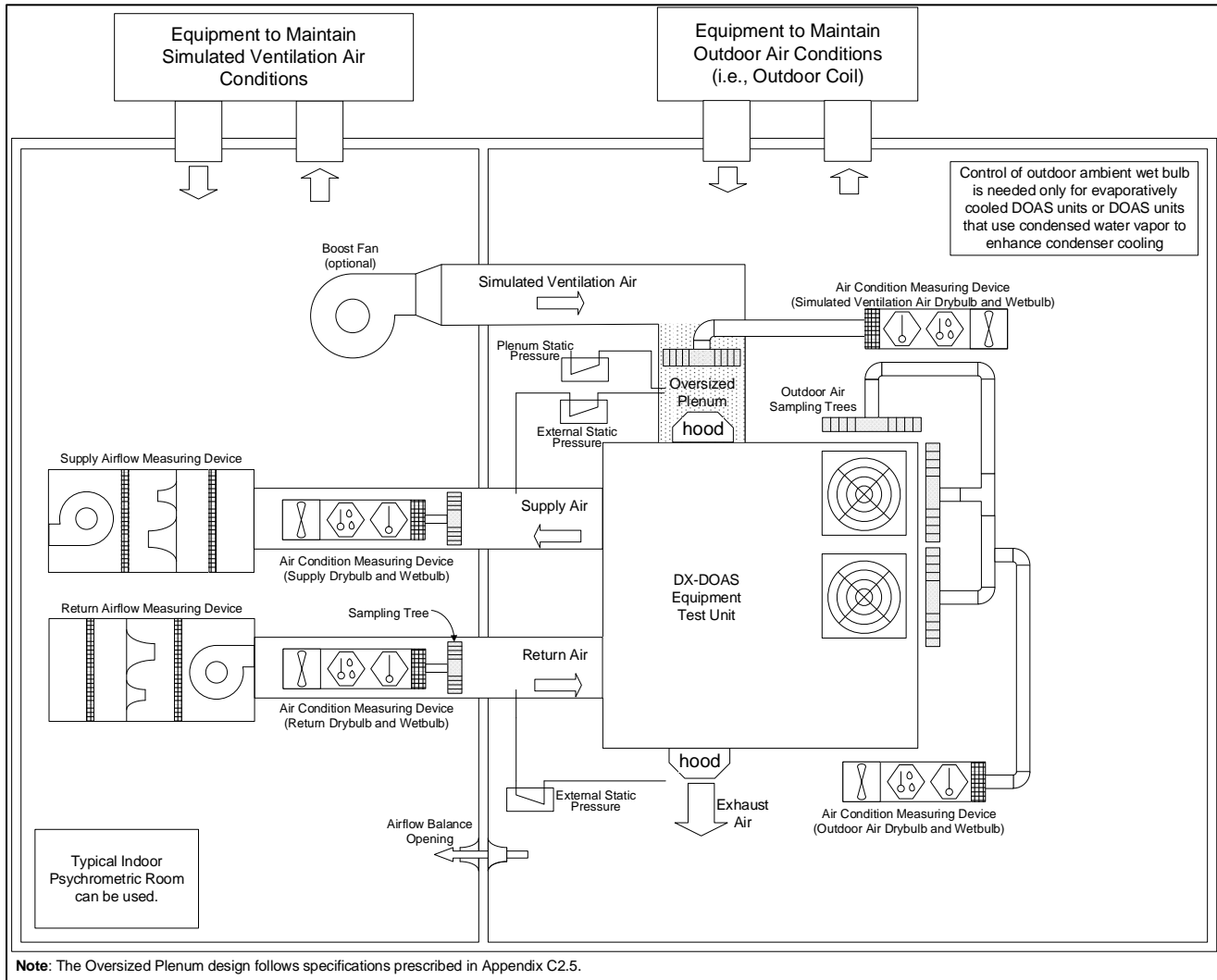

Figure E6. Single Package DX-DOAS with VERS (Option 2)

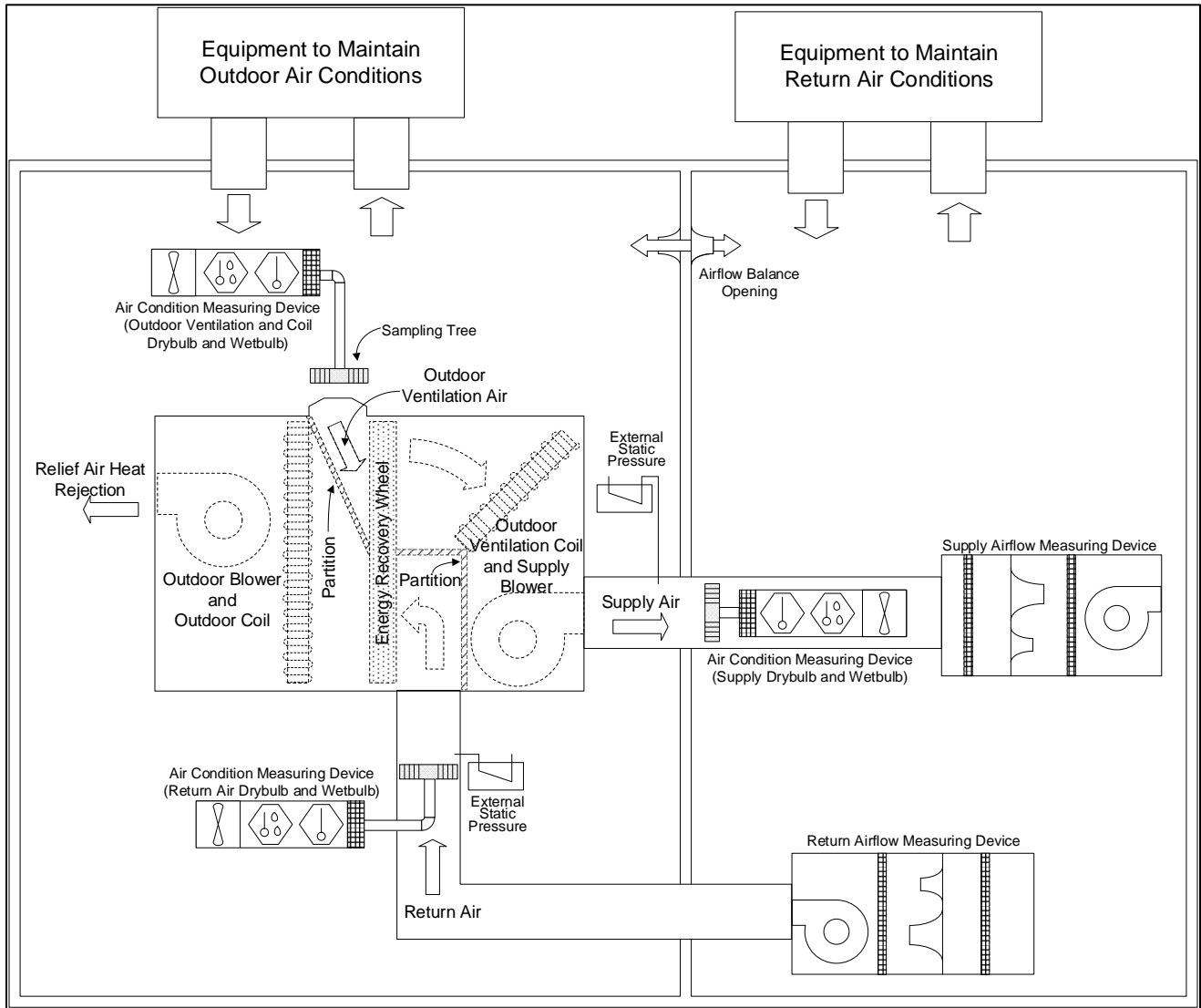

Figure E7. Relief-Air-Cooled DX-DOAS with or without VERS (Option 1)

APPENDIX F – UNIT CONFIGURATION FOR STANDARD EFFICIENCY DETERMINATION - NORMATIVE

F1 Purpose. The purpose of this appendix is to prescribe the requirements for the configuration of a unit to be used for determining the Moisture Removal, Heating Capacity and efficiency metrics at Standard Rating conditions. Certain requirements reduce burden by streamlining the amount of testing manufacturers need to do to rate their products.

F2 Configuration Requirements. For the purpose of Standard Ratings, units shall be configured for testing as defined in this Appendix.

F2.1 Individual Model. An Individual Model means a model distributed in commerce with a unique model number.

F2.2 Basic Model. A Basic Model means all units manufactured by one manufacturer within a single equipment class; with the same or comparably performing compressor(s), heat exchangers, ventilation energy recovery system(s) (if present), and air moving system(s); and with a common “nominal” moisture removal capacity.

F2.3 All components indicated in Sections F2.3.1 – F2.3.8 shall be present and installed for all testing, and shall be the components distributed in commerce with the unit. Individual models that contain/use (different or alternate) versions of the same component shall either be represented separately as a unique basic model or certified within the same basic model based on testing of the least efficient configuration. Any electric resistance heat coils used for primary or supplementary heating shall also be present and installed for testing individual models distributed in commerce with these components. Any VERS and exhaust/return air fan/motors shall also be present and installed for testing individual models distributed in commerce with these components.

F2.3.1 Supply Air filter(s). The filter shall have a specification no less than MERV 8. The lowest-MERV filter distributed in commerce with the DOAS model may be used if it exceeds MERV 8.

F2.3.2 Compressor(s)

F2.3.3 Outdoor coil(s) or heat exchanger(s)

F2.3.4 Outdoor coil fan(s)/motor(s) (air-cooled and air-source systems only)

F2.3.5 Conditioning coil(s)

F2.3.6 Refrigerant expansion device(s)

F2.3.7 Supply/outdoor ventilation fan/motor(s)

F2.3.8 System controls

F2.4 Optional System Features. The following features are optional during testing. Individual models with these features may be represented separately as a unique Basic Model or certified within the same Basic Model as otherwise identical individual models without the feature pursuant to the definition of “Basic Model”.

If an otherwise identical model (within the same Basic Model) without the feature is distributed in commerce, test the otherwise identical model.

If an otherwise identical model (within the same Basic Model) without the feature is not distributed in commerce, conduct tests with the feature present but configured and de-activated so as to minimize (partially or totally) the impact on the results of the test. Alternatively, the manufacturer may indicate in the supplemental testing instructions (STI) that the test shall be conducted using a specially-built otherwise identical unit that is not distributed in commerce and does not have the feature.

F2.4.1 Dampers.

F2.4.1.1 Return and Exhaust Dampers. An automatic system that enables a DX-DOAS Unit to supply

and use some Return Air [even if an optional VERS is not utilized] to reduce or eliminate the need for mechanical dehumidification or heating when ventilation air requirements are less than design. Such dampers may provide significant energy efficiency improvements on an annualized basis, but are also a function of load conditions, and are not considered in the MRC, MRE, ISMRE2, COP, IS COP2, or any -70 metric. All Standard 921 (SI) Ratings shall be based on 100% Outdoor Air. All dampers that allow return air to pass into the supply airstream shall be closed and sealed using tape or equivalent means to block any leakage. Exhaust air dampers of DOAS units with VERS shall be open—gravity-dampers activated by exhaust fan discharge airflow shall be allowed to open by action of the exhaust airflow.

F2.4.1.2 VERS Bypass Dampers. An automatic system that enables a DX-DOAS Unit to let outdoor ventilation air and return air bypass the VERS when preconditioning of outdoor ventilation is not beneficial. Such dampers may provide energy efficiency improvements on an annualized basis, but this is also a function of regional ambient conditions and is not considered in the ISMRE2 metric. If an otherwise identical individual model without VERS bypass dampers is not distributed in commerce, test with the VERS bypass dampers installed, closed, and sealed using tape or equivalent means to block any leakage. However, VERS bypass dampers may be opened if necessary for testing with deactivated VERS for Standard Rating Condition D.

F2.4.1.3 Fire/Smoke/Isolation Dampers. A damper assembly including means to open and close the damper mounted at the supply or return duct opening of the equipment. Such a damper may be rated by an appropriate test laboratory according to the appropriate safety standard, such as UL 555 or UL555S. If an otherwise identical individual model without fire/smoke/isolation dampers is not distributed in commerce, fire/smoke/isolation dampers shall be removed for testing. If it is not possible to remove such a damper, either test with the damper fully open or build and test an otherwise identical unit without such a damper.

F2.4.2 Furnaces and Steam/Hydronic Heat Coils. Furnaces and Steam/Hydronic Heat Coils used to provide primary or supplementary heating. If an otherwise identical individual model without furnaces or steam/hydronic heat coils is not distributed in commerce, test with the coils in place, or build and test an otherwise identical unit without such coils.

F2.4.3 Power Correction Capacitors. A capacitor that increases the power factor measured at the line connection to the equipment. These devices are a requirement of the power distribution system supplying the unit. Power correction capacitors shall not be present for testing.

F2.4.4 Hail Guards. A grille or similar structure mounted to the outside of the unit covering the outdoor coil to protect the coil from hail, flying debris and damage from large objects. Hail guards shall not be present for testing.

F2.4.5 Ducted Condenser Fans. A condenser fan/motor assembly designed for optional external ducting of condenser air that provides greater pressure rise and has a higher rated motor horsepower than the condenser fan provided as a standard component with the equipment. If an otherwise identical individual model without ducted condenser fans is not distributed in commerce, test with the ducted condenser fan installed and operating using zero external static pressure, unless the manufacturer specifies use of an external static pressure greater than zero, in which case, use the manufacturer-specified external static pressure.

F2.4.6 Sound Traps/Sound Attenuators. An assembly of structures through which the Supply Air passes before leaving the equipment or through which the return air from the building passes immediately after entering the equipment, for which the sound insertion loss is at least 6 dB for the 125 Hz octave band frequency range. If an otherwise identical individual model without sound traps/sound attenuators is not distributed in commerce, removable sound traps/sound attenuators shall be removed for testing. Otherwise, test with sound traps/attenuators in place or build and test an otherwise identical unit without the sound traps/attenuators.

F2.4.7 Humidifiers. A device placed in the supply air stream for moisture evaporation and distribution. The device may require building steam or water, hot water, electric or gas to operate. Humidifiers shall not be present for testing.

F2.4.8 *UV Lights.* A lighting fixture and lamp mounted so that it shines light on the Conditioning Coil, that emits ultraviolet light to inhibit growth of organisms on the Conditioning Coil surfaces, the condensate drip pan, and/or other locations within the equipment. UV lights shall not be present for testing.

F2.4.9 *Coated Coils.* A Conditioning Coil or Outdoor Coil whose entire surface, including the entire surface of both fins and tubes, is covered with a thin continuous non-porous coating to reduce corrosion. A coating for this purpose will be defined based on what is deemed to pass ANSI/ASTM B117 or ANSI/ASTM G85 test of 500 hours or more. Except for the coating, the coated coil shall have a design that is identical to that of the corresponding non-coated coil of another individual model within the same basic model.

F2.4.10 *VERS Preheat.* Electric resistance, hydronic, or steam heating coils used for preheating outdoor air entering a VERS. These coils shall not be present for testing.

F2.4.11 *High-Effectiveness Indoor Air Filtration.* Indoor air filters with greater air filtration effectiveness than the filters used for testing per Section F2.3.

APPENDIX G. VERIFICATION TESTING – NORMATIVE

G1 To comply with this standard, single sample production verification tests shall meet the certified Standard Rating performance metrics shown in Table G1 with the listed acceptance criteria.

Table G1. Acceptance Criteria	
Performance Metric	Acceptance Criteria
Dehumidification Metrics	
Full Load Moisture Removal Capacity	$\geq 95\%$
MRE	$\geq 95\%$
ISMRE2 ISMRE ₂₇₀	$\geq 90\%$
Heating Metrics	
Full Capacity Heating ($q_{hp,full,x}$), Total Heating Capacity-DOAS ($q_{hp,DOAS,x}$)	$\geq 95\%$
COP _{DOAS,E} COP _{DOAS,F}	$\geq 95\%$
ISCOP2	$\geq 90\%$