

Risk Assessment of HFC-32 and
HFC-32/134a (30/70 wt. %) in Split System
Residential Heat Pumps

Final Report

April, 1998

William Goetzler
Lisa Bendixen
Paula Bartholomew

Arthur D. Little, Inc.
20 Acorn Park
Cambridge, MA 02140 USA

Prepared for:
The Air Conditioning and Refrigeration Technology Institute
under
ARTI MCLR Project Number 665-52402

“This research project is supported, in whole or in part, by U.S. Department of Energy grant number DE-FG02-91CE23810: Materials Compatibilities and Lubricants Research (MCLR) on CFC-Refrigerant Substitutes. Federal funding supporting the MCLR program constitutes 93.57% of allowable costs. Funding from the air-conditioning and refrigeration industry supporting the MCLR program consists of direct cost sharing of 6.43% of allowable costs and significant in-kind contributions.”

DISCLAIMER

The U.S. Department of Energy's and the air-conditioning industry's support for the Materials Compatibility and Lubricants Research (MCLR) program does not constitute an endorsement by the U.S. Department of Energy, nor by the air-conditioning and refrigeration industry, of the views expressed herein.

NOTICE

This report was prepared on account of work sponsored by the United States Government. Neither the United States Government, nor the Department of Energy, nor the Air Conditioning and Refrigeration Technology Institute, nor any of their employees, nor of any of their contractors, subcontractors, or their employees, makes any warranty, expressed or implied, or assumes any legal liability or responsibility for the accuracy, completeness, or usefulness of any information, apparatus, product or process disclosed or represents that its use would not infringe privately-owned rights.

DISCLAIMER

This report was prepared by Arthur D. Little, Inc. for the Air Conditioning and Refrigeration Technology Institute. The material in it reflects Arthur D. Little's best judgment in light of the information available to it at the time of preparation. Any use which a third party makes of this report, or any reliance on or decisions to be made based on it, are the responsibility of such third party. Arthur D. Little accepts no responsibility for damages, if any, suffered by any third party as a result of decisions made or actions taken based on this report.

Table of Contents

1. Executive Summary	1-1
2. Background	2-1
2.1 Impact of CFCs and HCFCs on the Environment	2-1
2.2 HCFC-22 in Unitary Air Conditioning Systems	2-1
3. Scope and Approach	3-1
3.1 Scope of Work	3-1
3.2 Data Sources	3-1
3.3 Equipment Model for Risk Assessment	3-1
3.4 Refrigerant Properties	3-1
3.4.1 <i>Flammability Characteristics of HFC-32</i>	3-2
3.4.2 <i>Fractionation and Composition Variation of HFC-32/134a Blends</i>	3-3
3.4.3 <i>CFR of HFC-32/134a</i>	3-4
3.5 Current Uses of Flammable Refrigerants in Air Conditioning Systems	3-5
4. Refrigerant Ignition and Dispersion Tests	4-1
4.1 Small - Scale Ignition Testing	4-1
4.2 Large - Scale Testing	4-2
4.2.1 <i>Concentration Mapping</i>	4-2
4.2.2 <i>Ignition Testing</i>	4-3
5. Risk Assessment	5-1
5.1 Introduction	5-1
5.2 Consequence Analysis	5-1
5.2.1 <i>Explosions</i>	5-1
5.2.2 <i>Fires</i>	5-2
5.3 Characterization and Analysis of Leaks	5-3
5.4 Fault Tree Analysis	5-4
5.4.1 <i>Fault Trees</i>	5-5
5.4.2 <i>Ignition Sources</i>	5-9
5.5 System Operation	5-10
5.6 Servicing	5-11
6. Discussion of Results	6-1
7. Risk Mitigation	7-1
7.1 Improved Training of Service Personnel	7-1
7.2 Redesign Condensing Unit Electronics	7-1
7.3 Leak Reduction	7-1
7.4 Changes to Building Codes	7-2
8. Historical Fire Risks	8-1
8.1 U.S.	8-1
8.2 U.K.	8-1
9. References	9-1
10. Appendix A: UL Report on Small Scale Testing	10-1
11. Appendix B: FMRC Report on Large-Scale Testing	11-1
12. Appendix C: Fault Trees	12-1
13. Appendix D: Fault Tree Rationale	13-1

List of Figures

Figure 3-1: HFC-32/134a Equilibrium Composition as a Function of Temperature..... 3-4

List of Tables

Table 3-1: Properties of HCFC-22, HFC-32, and HFC-134a	3-2
Table 3-2: Flammability Characteristics of Selected Flammable Refrigerants	3-3
Table 4-1: Small Scale Ignition Source Test Results	4-1
Table 4-2: Concentration Mapping Test Results	4-3
Table 4-3: Large Scale Ignition Test Results	4-4
Table 5-1: Damage Effects of Overpressures	5-2
Table 5-2: Effects of Thermal Radiation	5-3
Table 5-3: Assumed Distribution of Air Handler Installations	5-4
Table 5-4: Residential Unitary Air Conditioner Saturation by Region, 1993	5-5
Table 5-5: Fault Trees	5-5
Table 5-6: Probability of Ignition	5-10
Table 6-1: Fire Frequencies	6-1
Table 6-2: Estimated Number of Fires by Region	6-1
Table 8-1: Fire Frequencies in the U.K.	8-2

1. Executive Summary

Flammable refrigerants such as HFC-32 and blends of HFC-32/134a have been proposed as HCFC-22 alternatives, due to concerns about the ozone depletion and global warming. Hydrocarbons such as propane have also been proposed and used as alternatives in a few cases, but to date their use has been limited as they are much more flammable than HFC-32. Therefore, in order to better understand the risks of the range of flammable refrigerants, a risk assessment focusing on marginally flammable refrigerants such as HFC-32 was performed, as such materials may be accepted even if hydrocarbons are deemed to be too hazardous.

Although substances like HFC-32 are flammable by currently accepted laboratory testing standards, their actual safety risks in real-world applications may be tolerably low. The environmental benefits of these refrigerants should be balanced with their potential safety risks, which have been estimated through a risk assessment of the use and service of residential unitary heat pumps which use HFC-32 and HFC-32/134a (30/70 % by weight). The design model chosen, a 5-ton (17.6 kW), 12-SEER split unitary heat pump, was chosen to represent a conservative configuration of typical unitary equipment sold in the U.S. today, where recent annual production of unitary equipment has been between 5 and 6 million units.

In the first phase of the project, small scale testing of various ignition sources was conducted at Underwriters Laboratories (UL) to determine whether these common sources could ignite pure HFC-32 and the blend under optimum conditions for ignition. This small scale testing was performed in a 1 ft³ (28.3 liter) plastic box containing the ignition source in the presence of a flammable mixture of the refrigerant and air. Ignition of HFC-32 was observed with a broken light bulb, high voltage arc, heater element with simulated current limiter and mixing fan failure, natural gas or propane pilot light (during ignition of the pilot), loose wires at high current draws, and some compressor contactors after repeated cycling. No ignition occurred with wall switches, fan motors, a brush motor from an electric drill, an intact halogen light bulb, low voltage arcs, a hot wire gas ignitor, or a resistance heater under normal or single fault conditions. Results for the blend were similar, except that the blend did not ignite from sparks from the loose wires, nor did it ignite for certain contactors which ignited HFC-32.

Full scale room testing of HFC-32, as well as HFC-32/134a (30/70 wt. %) in its worst case fractionated blend composition, was conducted to provide additional data for the risk assessment. These tests were performed in a 15 ft. long x 15 ft. wide x 10 ft. high (4.6 m x 4.6 m x 3.0 m) room at the Factory Mutual Research Center (FMRC). Two sets of tests were performed: concentration mapping tests and ignition tests. The first set of tests was used to characterize the diffusion of the leaked refrigerant, using sensors placed in the air handler, the room, and a duct. The second set of tests consisted of trying to ignite the leaking refrigerant with high-energy ignition sources which had ignited the refrigerant in the small-scale testing. Total release amounts were about 12 lb (5.5 kg) for the HFC-32 releases and about 7.2 lb (3.25 kg) for the blend. This HFC-32 charge corresponds to the

approximate charge that would be required for the 5-ton, 12-SEER system. The total charge of the blend would be about 14.3 lb (6.5 kg), but the release was only half that, since that amount of the worst case fractionated concentration includes all the HFC-32 that would be present in the system.

Slower releases of about 0.22 lb./min (100 g/min.) into the room without air flow showed flammable concentrations persisting for about 3 hours in a large portion of the room. Catastrophic releases into the room with flow rates above 4.4 lb./min (2 kg/min.), as well as slow or fast releases with air flow provided by a small fan, caused substantial turbulence and mixing, thereby reducing concentrations of the refrigerants below the lower flammable limit. Leaks into the air handler did not produce flammable concentrations within the air handler where the electric components are located. However, a fast leak in the air handler with the fan off produced flammable concentrations in the room near the floor, where the refrigerant leaked out of the air handler. Furthermore, after a leak in the air handler with the fan running at its lowest setting, there was no flammable concentration in the duct, due to the dilution of the refrigerant with air.

Since both the small scale ignition tests and the concentration mapping tests with the blend showed very similar behavior to that observed with HFC-32, pure HFC-32 was used for most of the large scale ignition tests. For these tests, a high voltage spark ignitor and natural gas pilot lights were used as ignition sources. Releases into the room at rates of about 0.22 lb./min (100g/min) were ignited by the high voltage arc, as expected. In addition, natural gas pilot lights located just outside a simulated utility closet ignited the refrigerant which dispersed after being leaked into an air handler located in the closet. There was also a very brief, self-extinguishing ignition (<2 seconds) of a pilot inside the closet in another test. Leaks into the room were not ignited by the pilot lights, though slow burning of the refrigerant was observed as the leak proceeded (i.e. the leaks did not produce a self-sustaining propagation of flame through the refrigerant). Leaks into ducts were not ignited in the ducts or after dispersion into the room from the duct terminal. In summary, it appears that the refrigerant could be ignited by the high voltage arc or the pilot light, but only under ideal conditions. Ignition by the pilot lights was particularly difficult, and most releases only caused small burnoffs of the leaking refrigerant, which were not self-sustaining.

A fault tree analysis was then conducted to estimate the frequency of fires and explosions that could result from substituting HFC-32 or HFC-32/134a (30/70 wt. %) for HCFC-22 in a residential unitary heat pump. In order to construct the fault trees, data on historical leak frequencies and characteristics were compiled from several manufacturers. Ignition probabilities were estimated based on the location and size of the leaks, as well as ambient conditions, drawing on the results of the earlier ignition testing. Ignition sources that were considered included hot gases such as natural gas or propane flames, electrical arcs from devices such as switches, motors or contactors, or hot surfaces such as strip

heaters. The assessment was based on a typical American home design, accounting for differences in installation configurations, which vary according to geographical region.

Overall, the risk of a fire resulting from use of HFC-32 is estimated to be about 1 per million units/year for operation and 3 per million units/year for service. Therefore, if HFC-32 was substituted for HCFC-22 in the entire U.S. installed base of 42 million residential air conditioners, we could expect less than 200 additional fires per year. [1] The likelihood of a fire occurring from operation of the unit is roughly double for units installed in the South compared to the Northeast, due to the increased chance of the unit being located in a closet in the South. The total fire risk for the HFC-32/134a (30/70 wt. %) blend is estimated to be about 20% lower than that of pure HFC-32. *By comparison, there are a total of about 518,000 residential fires reported annually in the U.S., of which about 114,000 are attributed to “heating systems.”* [2]

The risks could be reduced further by implementing risk mitigation strategies such as improved training of service technicians, simple redesign of electronic components, reduction of leaks, and changes to building codes to prohibit installation of air handlers and gas or oil-fired appliances in the same utility closet.

It is important to recognize that the risks due to use of HFC-32 or the blend are significantly less than the risk which might be expected from use of hydrocarbon refrigerants such as propane, because propane is more flammable than HFC-32 and may be ignited by a wider variety of sources with lower ignition energies. Therefore, the results of this study can not be generalized to more flammable refrigerants such as hydrocarbons.

2. Background

2.1 Impact of CFCs and HCFCs on the Environment

Chlorofluorocarbons (CFCs) were developed in the 1890's and first produced commercially in 1931. Commercial production of several CFCs, as well as hydrochlorofluorocarbons (HCFCs) such as HCFC-22 followed shortly thereafter. These compounds have since become widely used in a variety of applications, including working fluids for air conditioning and refrigeration equipment, aerosol propellants, and foam blowing agents for manufacturing thermal insulation.

In 1974, Rowland and Molina published their hypothesis regarding depletion of the stratospheric ozone layer. They theorized that CFCs diffuse into the stratosphere and break down due to photolysis, releasing chlorine atoms which act as catalysts to destroy stratospheric ozone in the earth's protective ozone layer. Since then, further evidence has accumulated to support their hypothesis. HCFCs such as HCFC-22 have a smaller impact on the ozone layer than CFCs, as measured by their ozone depletion potential (ODP). In response to these concerns, international agreements such as the Montreal Protocol were reached to curtail the production and use of ozone depleting substances such as CFCs and HCFCs. Subsequent amendments to the Montreal Protocol accelerated the phaseout, and various countries have implemented legislation further restricting the use of CFCs and HCFCs.

An additional environmental concern with respect to fluorocarbons is their global warming potential (GWP). Scientists believe that when these substances are released into the atmosphere, they allow short-wave radiation to pass through them, but absorb part of the heat energy that is re-radiated from the earth's surface. This phenomenon, commonly referred to as the "Greenhouse Effect," could raise the earth's temperature, resulting in significant environmental impact. The likelihood and extent of this impact are much disputed. However, some governments have implemented or are considering regulation to curb the use of fluorocarbons to reduce their global warming impact. Additional regulation in the future is possible in much of the world, in response to the targets agreed to at the 1997 meetings in Kyoto. The global warming impact of fluorocarbons, including hydrofluorocarbons (HFCs), varies significantly, so the choice of an HFC can also affect global warming.

2.2 HCFC-22 in Unitary Air Conditioning Systems

HCFC-22 is used in the vast majority of the approximately 200 million air conditioners and heat pumps in the world, representing about 1.4 billion kW of cooling capacity. The United States and Japan account for approximately 90-95% of these units, so the impact of the HCFC-22 phaseout is most acute in these two countries. [3,4]

Several HCFC-22 alternatives such as R-407C and R-410A, both of which are HFC blends, have been proposed. Both have drawbacks, either in reduced efficiency or a requirement for major compressor and system redesign. Other possibilities, which also have some design drawbacks, include HFC-32 or the blend of HFC-32/134a (30/70 wt. %). HFC-32 would require significant redesign but could also offer performance advantages. The HFC-32/134a blend might offer similar efficiency to HCFC-22, with limited requirements for system redesign. Both of these alternatives are also considered flammable. The purpose of this study was to assess the safety risks of both pure HFC-32 and HFC-32/134a (30/70 wt. %) in a typical American air conditioning or heat pump system.

3. Scope and Approach

3.1 Scope of Work

The purpose of this risk assessment program was to evaluate the risks during operation and service of using HFC-32 or HFC-32/134a (30/70 wt. %) in a split system residential heat pump. The first phase involved information gathering about the use of flammable refrigerants throughout the world. Information on leak rates, frequencies, and characteristics was then obtained from several manufacturers, and in cooperation with them and Underwriters Laboratories (UL), potential ignition sources were reviewed. The next task involved small scale testing of these ignition sources under laboratory conditions at UL. Large scale room testing at the Factory Mutual Research Center (FMRC) was then conducted to map concentration profiles of simulated leaks and then attempt to ignite these leaks in a simulated room environment. After all the data were collected and the testing was completed, Arthur D. Little, Inc. (ADL) performed a risk assessment using fault tree analysis to estimate the risk of fires which might occur during service and operation of a residential heat pump using HFC-32 or HFC-32/134a (30/70 wt. %). Risks during manufacturing, transport, and disposal were not considered in the study.

3.2 Data Sources

Data for this study was based on information supplied by three major American manufacturers of unitary air conditioners and heat pumps. We also interviewed a number of service engineers to obtain information on current work practices, particularly for activities relating to repair work. Data was validated by comparison to proprietary data gathered by ADL for previous studies on air conditioning systems.

3.3 Equipment Model for Risk Assessment

The equipment model for this risk assessment was a 5-ton (17.6 kW) 12-SEER unitary heat pump, which is represented in our analysis and room testing by a Carrier 38BYB-060 condensing unit and an FC4A-070 air handler. This product was chosen to represent a conservative configuration of the typical unitary heat pump sold in the U.S. today. The size and efficiency level are both at the high end of common residential installations and therefore require a relatively large refrigerant charge.

3.4 Refrigerant Properties

Properties of HCFC-22, HFC-32, and HFC-134a are shown in [Table 3-1](#).

Table 3-1: Properties of HCFC-22, HFC-32, and HFC-134a

Parameter	HCFC-22	HFC-32	HFC-134a
Name	chlorodifluoromethane	difluoromethane	1,1,1,2-tetrafluoroethane
Chemical Formula	CHClF ₂	CH ₂ F ₂	CF ₃ CH ₂ F
ODP	0.05	0	0
GWP (to CO ₂ , 100 yr. integr.)	1500	650	1300
Molecular Weight	86.5	52	102.03
Boiling Point at 1 atm (°C)	-41	-52	-26
Critical Temperature (°C)	96.2	78.2	101
Critical Pressure (kPa)	4990	5797	4052
Flammable Limits in Air (%)	none	13-29 ¹	none
ASHRAE Std. 34 Designation	A1	A2	A1

Source: [5]

¹Published values for UFL at room temperature range from 29% to 33%, depending on the source and test procedure.

3.4.1 Flammability Characteristics of HFC-32

HFC-32 is the flammable component of the HFC-32/134a (30/70 wt. %) blend and is therefore the fluid of interest in this study. Pure HFC-32 would be the limiting case in characterizing the blend’s flammability (i.e., addition of HFC-134a reduces the blend’s flammability).

HFC-32 is classified as A2 by ASHRAE Standard 34. [6] The letter A places it in the lowest toxicity category, while the number 2 identifies it as a “lower flammability” substance. Fluids which show no flame propagation by ASTM Standard E681, as modified by ASHRAE Standard 34, are classified as Class 1 and generally accepted as non-flammable. [7] Examples include the traditional refrigerants such as CFC-12, HCFC-22, as well as newer ones like HFC-134a and HFC-125. Class 2 fluids show flame propagation, with an LFL of over 0.10 kg/m³ at 23 °C and 101 kPa, and a heat of combustion of less than 19,000 kJ/kg. Examples include HFC-32 and HFC-152a. Class 3 refrigerants are deemed highly flammable, and have an LFL less than or equal to 0.10 kg/m³ at 23°C and 101 kPa, or a heat of combustion greater than 19,000 kJ/kg. Examples include substances like propane (R-290) and isobutane (R-600a).

Other flammability standards classify refrigerants differently. For example, the Japanese High Pressure Gas Safety Law classifies a substance as flammable if the LFL is less than or equal to 10% by volume in air, or if the range between the upper and lower flammable limits is greater than 20%. By this criterion, HFC-32 is not considered flammable, though it is also not clearly identified as non-flammable.

As shown in Table 3-2, by common criteria, HFC-32 is significantly less flammable than fluids such as HFC-152a or propane, which are some other common flammable refrigerants, and rather similar in flammability to ammonia. Various laboratory tests have

also confirmed this. Nevertheless, HFC-32 and blends such as HFC-32/134a (30/70 wt. %) are often perceived to be as flammable as other, more flammable substances.

Table 3-2: Flammability Characteristics of Selected Flammable Refrigerants

Fluid	LFL (volume %)	Autoignition Temperature (°C)	Minimum Ignition Energy (millijoules)	Heat of Combustion (MJ/kg.)
HFC-32	14	648	170	9.4
HFC-152a	4.0	455	< 22	16.9
HC-290 (propane)	1.9	504	0.15	50.3
HC-600 (n-butane)	1.5	430	*	49.5
HC-600a (isobutane)	1.5	460	*	49.4
R-717 (ammonia)	15	651	*	22.5

Sources: [5, 8, 9]

* Minimum ignition energy has not been reported for these substances.

3.4.2 Fractionation and Composition Variation of HFC-32/134a Blends

HFC-32/134a is a zeotropic blend, so the liquid and vapor compositions vary from the nominal composition depending on operating conditions, temperature, and leak rate. It is important to understand this phenomena in order to construct accurate risk scenarios. In other words, we need to know what is the worst case composition that we could expect under realistic operating conditions, and to determine if this composition is flammable.

Since HFC-32 has a higher vapor pressure than HFC-134a, the concentration of HFC-32 is higher in the saturated vapor phase than in the saturated liquid phase. The concentration of HFC-32 in the vapor increases as the ambient temperature decreases. Since HFC-32 is flammable and HFC-134a is non-flammable, the blend becomes more hazardous as the temperature decreases. Thus, a worst case risk scenario occurs when the ambient temperature is low.

Figure 3-1 shows the equilibrium vapor/liquid composition of HFC-32/134a as a function of ambient temperature, as calculated from the computer program REFPROP. [10] For example, if the nominal liquid composition is (30/70 wt. %), we would expect the gas to contain about 49% HFC-32 at 20°C, 53% HFC-32 at 0°C and 57% HFC-32 at -20°C. In general, experimental values agree closely with these predictions, except that the very first few percent of a leak may be richer in HFC-32 than the equilibrium condition would suggest. After the first 2% of the leak, the leaked gas composition follows REFPROP predictions quite accurately.

Figure 3-1: HFC-32/134a Equilibrium Composition as a Function of Temperature

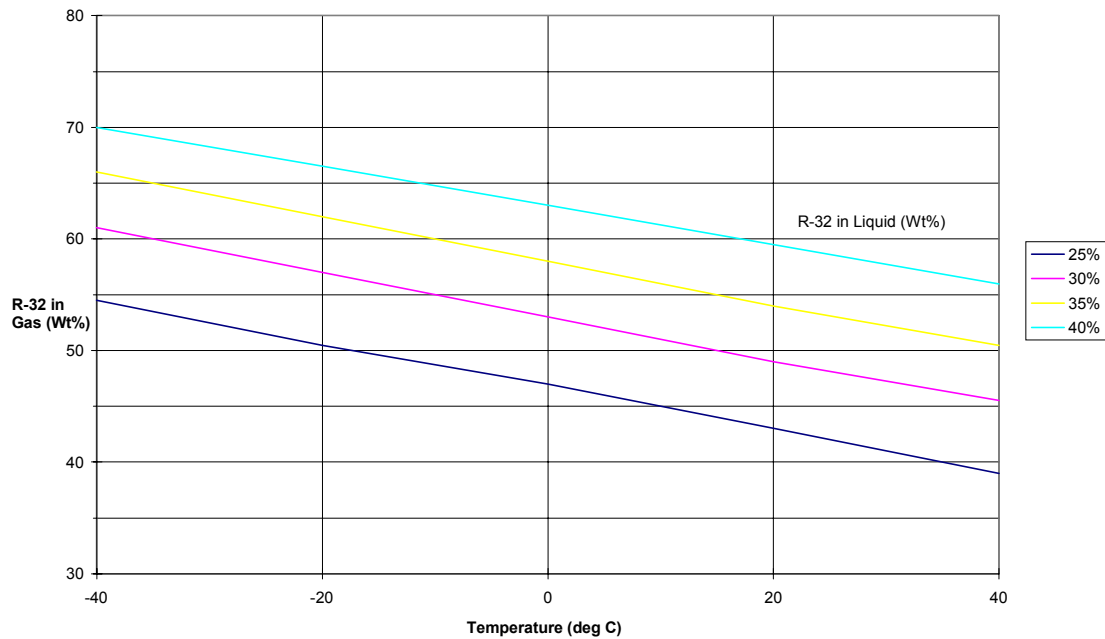

3.4.3 CFR of HFC-32/134a

The critical flammability ratio (CFR) of a blend is the ratio of the flammable to non-flammable components at the limit of flammability of the blend in air. It can be understood as the limiting case of flammable to non-flammable compositions. The CFR of the HFC-32/134a blend has been the subject of considerable debate. Some laboratories have found that HFC-32/134a (56/44 wt. % HFC-32/HFC-134a) is the CFR boundary at room temperature. [11,12] The most conservative room temperature values reported for the CFR are in the range of (40/60 wt. % HFC-32/HFC-134a) [13]. Humidity, ignition source, test temperature, and test vessel all affect the test results. Thus, taking conservative CFR values, it is easily conceivable that a leak from a system charged with HFC-32/134a (30/70 wt. %) could be flammable, even during warm weather. As shown in Figure 3-1, at room temperature, the gas in equilibrium with the liquid at the nominal composition of HFC-32/134a (30/70 wt. %) contains nearly 50% HFC-32, well within the flammable range.

3.5 Current Uses of Flammable Refrigerants in Air Conditioning Systems

Although there has been considerable interest recently in flammable refrigerants, as well as some usage in domestic refrigerators in Northern Europe, there are few examples of flammable refrigerants being used in direct expansion (DX) air conditioning systems. Hydrocarbons are widely used in domestic refrigerators in Germany, but those systems use much smaller refrigerant charges than would be required in air conditioners and heat pumps. Flammable refrigerants such as hydrocarbons and ammonia are used with larger refrigerant charge sizes in many countries in systems with secondary cooling loops, such as chillers and supermarket refrigeration systems. However, these are specialized systems used in controlled environments. Our interest in this study has been to determine whether flammable refrigerants are being used in typical DX air conditioning systems such as the ducted unitary equipment common in the US or the ductless split units used in other parts of the world.

Flammable refrigerants, specifically hydrocarbons, are being promoted most heavily in Europe, particularly Germany and Scandinavia. We know of no current applications where flammable HFCs such as HFC-32 and HFC-32/134a are being used, although Japanese companies have expressed considerable interest in these refrigerants.

There are reportedly a few small air conditioner manufacturers in Germany who are currently selling or plan to sell hydrocarbon air conditioners, but their sales volume is small. More important is an Italian company which produces portable, single package, room air conditioners using propane as a refrigerant. According to this company, the product was introduced in Germany in 1995, and will be sold in other European markets by 1998. The manufacturer claims to have sold 60,000 of these units in 1995-96, but some observers are skeptical of this figure and believe actual sales are lower. The products have a propane charge of about 0.45 lb. (200 grams), and are priced about 10-15% higher than similar HCFC-22 units, but the price differential also reflects other environmentally friendly features such as recyclable plastics. Ductless split units are under development for introduction in 1999.

One British company plans to introduce air conditioners which use a hydrocarbon blend, consisting of 90% propane as well as some ethane and isobutane. The products will be ductless split systems with wall mounted indoor units in capacities from 0.5-3 tons (1.8-10.5 kW), and ceiling recessed units with capacities of 1.5-4.5 tons (5.3-15.8 kW). The maximum charge will be as high as 5.5 lb. (2.5 kg.). The products will be introduced first in the U.K., and then in continental Europe. The performance is claimed to be slightly better than the HCFC-22 units, and the price is about 6-7% higher. Key design changes made to improve safety with the flammable charge include use of all solid state switching, an enclosed fan motor, all brazed connections, and remote electronics.

4. Refrigerant Ignition and Dispersion Tests

4.1 Small - Scale Ignition Testing

Small scale ignition testing of various potential ignition sources was conducted by UL and is described in detail in their report, which is included in [Appendix A](#). For the blend tests, a conservative formulation of the worst case fractionated blend was used. This worst case fractionated formulation was HFC-32/134a (60/40 wt. %). The test results are summarized in [Table 4.1](#).

Table 4-1: Small Scale Ignition Source Test Results

Ignition Source	Characteristics	Represents	R-32 Ignition	R-32/134a (60/40 Ignition)
High Voltage	15,000 V secondary	For certain ignition	Y	Y
Low voltage Arc	17,000 V secondary peak 24 V input	Oil-fired residential furnace ignitor	Y	Y
		Gas fired residential furnace ignitor	N	N
Electric Spark Across Wires	240 V, 96 A, 42 PF 120 V, 72 A, 50 PF 120 V, 16 A, 75 PF	Loose wires at LRA*	Y	N
		Loose wires at LRA*	Y	N
		Loose wires at typical wall current	N	-
Supplemental Heating Element	Normal operating temperature Red hot White hot	Normal operation	N	N
		No air flow	N	N
		Current limiter failure	Y	Y
Hot Wire Ignitor	120V rated	120V rated	N	N
Light Bulb	Envelope broken Halogen (intact)	Broken bulb	Y	Y
		Normal operation	N	-
Match	Ohio Blue Tip Wooden Match	--	Y	Y
Switches	120V, 96A, 50% PF 120V, 72A, 50% PF 120V, 15.2A	120V, 96A, 50% PF	N	--
		120V, 72A, 50% PF	N	--
		120V, 15.2A	N	--
Open Flame	Propane Natural Gas	Pilot light - water heater, furnace	Y	Y
		Pilot light - water heater, furnace	Y	Y
Motor	Open, 240V, 5.4A 3/4 hp Totally enclosed, 240V, 1.4A, 1/4hp Electric Drill, 120V, 2.2A	Condenser Fan	N	N
		Evaporator Blower Motor	N	N
		Electric Drill	N	N
Contactor	240V, 96A, 42 PF, Open 240V, 35A, 77 PF, Open 240V, 96A, 42 PF, Top Removed 240V, 20.5A, 47 PF, Open	Compressor at LRA*	Y ¹	Y ²
		Compressor at FLA	Y ³	N
		Compressor at LRA*	N	--
		Evaporator Motor at LRA*	N	--

* locked rotor amperage

¹ Ignition on 1st, 7th, 16th, and 20th cycles

² Ignition on 4th and 5th cycle

³ Ignition only after many cycles

Both pure HFC-32 and the worst case fractionated blend were ignited by an open flame (propane or butane pilot light, burning match), a very high voltage arc, an abnormally hot wire (broken envelope light bulb, white hot resistance heater with failed current limiter), and repeated cycling of an open compressor contactor breaking an abnormally high (96 amp @240V) current. Pure HFC-32 was also ignited by sparks from loose wires at

locked rotor amperage (LRA). However, motors, an electric drill, wall switches, an intact halogen light bulb, low voltage arcs, a 120 V hot wire gas ignitor, a 120V/16 amp normal load current electric spark, and an evaporator motor contactor did not ignite HFC-32 and were therefore assumed not to ignite the blend. In summary, it appears that the most likely ignition sources would include a burning match, a pilot flame and a high voltage arc. Contactors, hot wires, and loose wires ignited the refrigerant only under abnormal conditions.

4.2 Large - Scale Testing

Large scale room testing was conducted by the Factory Mutual Research Center and is described in further detail in their report, which is attached as [Appendix B](#). The testing consisted of two tasks, concentration mapping and ignition source testing. Total release amounts were about 12 lb (5.5 kg) for the HFC-32 releases and about 7.2 lb (3.25 kg) for the blend. This HFC-32 charge corresponds to the approximate charge that would be required for the 5-ton, 12-SEER system. The total blend charge would be about 14.3 lb (6.5 kg), but the release was only half that, since that amount of the worst case fractionated concentration includes all the HFC-32 that would be present in the system.

4.2.1 Concentration Mapping

The purpose of the concentration mapping tests was to characterize the diffusion of the leaked refrigerant by placing flame ionization detector (FID) sensors at various points in the room and duct. Releases of both pure HFC-32 and also a conservative formulation of the worst case fractionated blend HFC-32/134a (60/40 wt. %) were performed. Releases of approximately 0.22 lb./minute (100 g/min.) showed flammable concentrations persisting for about 3 hours in a large portion of the room. Very fast releases of greater than 4.4 lb./minute (2 kg/min.), as well as slow or fast releases with a small fan nearby to simulate outdoor conditions, caused large amounts of turbulence and mixing, thus reducing refrigerant concentrations below the flammable limit in less than a minute.

Leaks into the air handler did not produce flammable concentrations within the air handler where the electric components are located. However, a fast leak in the air handler with the fan off produced flammable concentrations in the room near the floor, where the refrigerant leaked out of the air handler. Furthermore, after a leak in the air handler with the fan running at its lowest setting, there was no flammable concentration in the duct, due to the heavy dilution of the refrigerant with air. The test results are summarized in [Table 4-2](#).

Table 4-2: Concentration Mapping Test Results

Test No.	Description ¹	Results
1	Fast Release, R-32, Room, Quiescent Conditions	No concentration observed within flammable region, due to high turbulence
2	Slow Release, R-32, Room, Quiescent Conditions	Within flammable region (See test #9)
3	Slow Release, R-32, Room, with 36 CFM Fan On	No concentration observed within flammable region, due to dilution with air from small fan
4	Fast Release, R-32, Room, Quiescent Conditions, Gas Sampling Lines Raised	No concentration observed within flammable region, due to high turbulence, except perhaps within first 2-3 minutes, before first sampling cycle complete
5	Fast Release, R-32, Air Handler, Blower Off	Within flammable region for several minutes near release point and near floor outside of air handler
6	Slow Release, R-32, Air Handler, Blower Off	Maximum concentration over 50% LFL, but never reaches LFL
7	Fast Release, R-32, Air Handler, Blower On at 900 CFM, (Too Little R-32 Released)	Invalid test
8	Repeat Test #7	No flammable concentration observed, but could have developed flammable concentration in first few minutes within air handler, before first sampling cycle
9	Slow Release, R-32, Room, Quiescent	Flammable concentration observed for extended time of about 2 hours, at 6 and 12 inch height, up to 8 feet away from release point
10	Fast Release, 60/40 blend, in Air Handler (Closet Test)	Flammable concentration persists for about 5 minutes within closet and air handler and slightly outside the closet near the floor
11	Repeat Test #10 with Sampling Lines Moved	Flammable region within closet persists for about 5-10 minutes; near floor outside the closet, flammable region persists for up to 30-45 minutes
12	Slow Release, 60/40 Blend in Air Handler (Closet Test)	Does not reach LFL, but reaches 50% LFL for up to about 2 hours
13	Fast Release, R-32, in Air Handler (Closet Test)- Too little R32 Released	Invalid test
14	Repeat Test #13	Similar to test 11, but flammable region near floor outside closet persists for about 45 minutes to an hour

¹ Fast release rate is approximately 5.5 lb/minute (2.5 kg/ min), while slow release rate is approximately 0.22 lb./minute (100 g/min).

4.2.2 Ignition Testing

Since both the small scale ignition tests and the concentration mapping tests with the blend showed similar behavior to that observed with HFC-32, HFC-32 was used for the majority of the large scale ignition tests. For the room tests, a high voltage spark ignitor and natural gas pilot lights were used as ignition sources. Releases into the room at rates of about 0.22 lb/minute (100g/min) were ignited by the high voltage arc, as expected. In addition, natural gas pilot lights located just outside a simulated utility closet ignited the refrigerant which dispersed after being leaked into an air handler located in the closet. There was also a very brief ignition of leaked refrigerant by a pilot inside the closet in another test. Leaks into the room were not ignited by the pilot lights, though slow burning of the refrigerant was observed as the leak proceeded. Leaks into ducts were not ignited in the ducts or after dispersion into the room from the duct terminal. In summary,

it appears that the refrigerant could be ignited by the high voltage arc or the pilot light, but only under ideal conditions. Ignition by the pilot lights was particularly difficult, and most releases only caused small burnoffs of the leaking refrigerant. The large-scale ignition tests are summarized in [Table 4-3](#).

Table 4-3: Large Scale Ignition Test Results

Test No.	Setup	Ignition Source	Ignition Source Location	Results
1	Fast release into air handler (with heating element on) in closet	2 pilots inside closet, arc outside	2 pilots inside closet 3 inches high, 8 inches from E. side and 12 inches from N. side; arc 12 inches from closet door, 3 inches high	arc ignition, brief (<2 s) self-extinguishing pilot ignition inside closet
2	Fast release into air handler in closet	2 pilots outside closet, electric heating coil in air handler	pilots at 3 inch height 12 inches from door, one at door centerline and one 12 inches from centerline; lowest coil energized	no ignition in air handler; ignition outside
3	Slow release into room	3 pilots	all at 3 inch height, one 12 inches from release along diagonal, one 48 inches from release along diagonal, and one 48 inches from release near pan south edge	2 pilots quickly burned out; third one burned off R-32 as release proceeded
4	Slow release into room	1 arc ignitor	arc at 3 inch height, 12 inches from release point along diagonal	repeated ignitions by arc, traveling back to release point
5	Fast release into room	3 pilots	same configuration as test 3	no ignition
6	Ultra-slow release into room	3 pilots	same configuration as test 5	no ignitions but small burnoffs
7	Slow release into room	3 arc ignitors	arc directly below release point, 12 inches away, and 24 inches away along diagonal, all at 3 inch height	repeated ignitions by first arc, traveling back to release point
8	Fast release into return duct	3 arc ignitors	one arc directly below center of diffuser at 3 inch height; 2 arcs 18 inches from center of diffuser, one at 3 inch height and one at 34 inch height	no ignition
9	Slow release into return duct	3 arc ignitors	same configuration as test #8	no ignition
10	Slow release into room with obstacle	3 pilots	all pilots at 3 inch height, located at 24 inch intervals from release point, all 6 inches from south pan edge, with a vertical sheet metal obstacle (18" long x 24" high) installed on the west pan edge	#2 pilot blown out; small burnoffs as R-32 was released

5. Risk Assessment

5.1 Introduction

Though HFC-32 has potential advantages as an alternative refrigerant, it is flammable and presents some level of risk should the refrigerant leak and be ignited. The blend, consisting of 30% HFC-32 and 70% HFC-134a by weight, is considered non-flammable in its as-formulated state. However, the blend can fractionate to a flammable composition. A set of fault trees has been developed to investigate and quantify potential leak and ignition scenarios, in order to investigate the likelihood of a potential fire or explosion following ignition of a leak of HFC-32 or the blend.

5.2 Consequence Analysis

It has been generally accepted, and test results have confirmed the initial assumption, that even in a relatively tight room of normal residential dimensions, a slow leak of even a very large refrigerant charge will disperse rapidly enough so that no localized area will remain at the LFL for a long enough period of time to present a significant risk of ignition. Therefore, catastrophic leaks, defined as the loss of a substantial amount of refrigerant within a few minutes, are of primary interest.

5.2.1 Explosions

The release and ignition of a flammable refrigerant could potentially cause damage and injury due to overpressure or debris from an explosion of the flammable vapor, and thermal radiation due to a fire could cause injury to people or destruction of property.

An explosion is a sudden increase or release of pressure above ambient levels. The overpressure generated by an explosion depends on the degree of confinement, the volume of the fluid, and the properties of the flammable gas. Overpressure decreases with distance from the edge of the explosion. As shown in [Table 5-1](#), an overpressure of about 5.1 psi (35 kPa) is required to cause significant direct biological damage to humans, but overpressures of 2-4 psi (14-28 kPa) can cause substantial damage to buildings, which could, in turn, severely injure occupants. [\[14,15\]](#) Other references give slightly different values for minimum overpressure to cause the damage described in [Table 5-1](#).

Data on overpressures caused by ignition of HFC-32 or its blends is scarce. No data was found for a room environment representative of real-world operating conditions, but some laboratory data exists. Heinonen, et. al. observed overpressures as high as 18.4 psi (127 kPa) for pure HFC-32, 0.1 psi (0.6 kPa) for HFC-32/134a (30/70 wt. %), and 1.6 psi (11 kPa) for HFC-32/134a (50/50 wt. %) in a 7930 cm³ (9.8 inch or 25-cm diameter) explosion sphere. [\[16\]](#) In contrast, overpressures of up to 30 psi (207 kPa) were

Table 5-1: Damage Effects of Overpressures

Overpressure (kilopascals)	Damage Effect
1-7	Shattering of glass windows
7-14	Repairable damage to buildings. Failure of wood siding panels. Shattering of asbestos siding. Corrugated steel and aluminum panel failure.
14-28	Roof collapse. Non-reinforced cinder block walls shattered. 50% destruction of brick buildings. Steel frame building distorted.
35	Eardrum rupture. Shattering of unreinforced concrete wall panels 20-30 cm thick.
105	Severe structural damage
240	1% fatality. Total structural damage
345	50% fatality
485	99% fatality

observed with propane. However, in a special test with a high-energy (70 Joule) ignition source, they had previously observed an overpressure of 103 psi (710 kPa) with pure HFC-32. In the 5 liter flask normally used for ASTM E681 testing, they observed overpressures as high as 4.4 psi (30 kPa) for pure HFC-32, 0.3 psi (2 kPa) for HFC-32/134a (30/70 wt. %), and 2.9 psi (20 kPa) for HFC-32/134a (50/50 wt. %).

Since these overpressures were observed in tightly confined, small volumes, and since overpressures decrease quickly with distance, one would expect substantially lower overpressures in a room, for similar quantities of refrigerant. During the room testing conducted at FMRC, described in [Section 4.2](#), pressure transducers were installed in the walls of the room. No measurable pressure rise was observed during any of the ignitions, and no explosions were observed. Thus, it appears highly unlikely that an explosion of HFC-32 or HFC-32/134a would cause substantial damage or injury. However, the data is inconclusive, so it must be assumed that any explosion is an unacceptable scenario.

5.2.2 Fires

A far greater concern is fires. As described above, both HFC-32 and HFC-32/134a (30/70 wt. %) in its worst case fractionated state are flammable by commonly accepted test standards. Thermal radiation from a fire causes burns on bare skin if the intensity and duration of radiation exposure is large enough, and intensity decreases with distance from the fire. [Table 5-2](#) shows the levels of thermal radiation necessary to cause pain and ignite combustibles. [8] Observation of testing at FMRC indicated that combustibles could be ignited by fires caused by HFC-32 and its blends. It is clear that thermal radiation intensities exceeding 25 kW/m² were present.

Table 5-2: Effects of Thermal Radiation

Radiation Intensity (kW/m²)	Observed Effect
37.5	Sufficient to cause damage to process equipment
25	Minimum energy required to ignite wood at indefinitely long exposures (non-piloted)
12.5	Minimum energy required for piloted ignition of wood and melting plastic tubing
9.5	Pain threshold reached after 8 seconds; second degree burns after 20 seconds
4	Sufficient to cause pain to personnel if unable to reach cover within 20 seconds; however, blistering of the skin (second degree burns) is likely; 0% lethality
1.6	Will cause no discomfort for long exposures; similar to solar radiation

5.3 Characterization and Analysis of Leaks

An estimate for leak frequencies was obtained by interviewing three major American heat pump manufacturers, in addition to comparison with proprietary data held by ADL from previous studies of air conditioning systems. Some manufacturers supplied values based on the first year(s) of warranty. Although leak frequencies near the end of the product life cycle may be comparable or even higher than during the warranty period, the average frequency over the product lifetime would typically be lower than that during the warranty period. Values from first year warranty data would therefore tend to be conservative.

We have estimated a typical leak frequency of 0.01 leaks/unit-year, which includes all sizes of leak from slow to catastrophic. A catastrophic leak involves a rapid discharge over a few minutes, for example following a line rupture in the refrigeration loop. This type of release presents a higher level of risk because the material is more likely to form a flammable zone both within and external to the unit. However, in some extreme cases, the velocity with which a catastrophic leak is released will enhance dispersion, and a flammable concentration may be achieved only momentarily at the moment of release. The dispersion of a release is a complex process depending on a number of factors such as climatic conditions, physical properties of the material, and obstacles in the vicinity of the release. Experimental testing is therefore a valuable way to understand the mechanics of refrigerant dispersion for a given system.

Precise data on the distribution of leak sizes and rates is unavailable. However, from interviews with various air conditioner manufacturers and service contractors, we concluded that the number of catastrophic failures is small in comparison to slow leaks. For the purposes of this study, we conservatively assumed that 95% of leaks are slow, and 5% are catastrophic releases.

Data on location of leaks is limited, and we therefore evaluated the distribution of leaks based on location within the system rather than on specific components within each unit. Analysis of data from several heat pump manufacturers yielded a conservative

assumption that the number of leaks from the indoor air handler and the outdoor condensing unit is approximately equal. It should be recognized, however, that the ratio is design-specific to some extent. Some manufacturers have experienced more leaks in one section than the other. There is also potential for a leak from the piping between the indoor and outdoor units, particularly in the wall void. We therefore assumed the following distribution of leaks:

- 45% from the indoor air handler,
- 45% from the outdoor condensing unit, and
- 10% from the piping between the two units.

5.4 Fault Tree Analysis

The split system heat pump consists of two distinct units: the outdoor condensing unit and the indoor air handler, connected by a refrigerant pipe which penetrates through a wall. Heating or cooling requirements are satisfied within the home by circulating conditioned air through ducts. The condensing unit is generally situated on the ground outside, whereas the air handler is located inside in one of three possible locations: the basement or garage, the attic, or a utility closet.

Scenarios for leaks from air handlers in the basement/garage, the attic, or a closet are each considered separately for two reasons. Firstly, the potential ignition sources differ by location. In addition, the dispersion of the leak is affected by the confinement of the location, particularly for a closet installation.

The distribution of these types of installation depends on which area of the United States is under consideration. For the purposes of this study, our baseline installation for evaluation was in the Northeast, where a basement or garage installation is most common. Table 5-3 shows the assumed distribution of installations for the Northeast, South, West, and Midwest. In the South and West, the number of closet installations is significantly higher because basements are less common than in the Northeast. In the Midwest, we assumed that all three installation configurations were equally likely.

Table 5-3: Assumed Distribution of Air Handler Installations

Region	Basement/Garage (%)	Utility Closet (%)	Attic (%)
Northeast	85	5	10
South or West	5	50	45
West	5	50	45
Midwest	33	33	33

In order to estimate the overall number of fires that would be expected, regional differences in residential unitary air conditioning saturation should be considered.

Table 5-4 shows this data for the most recent year available, 1993. [19]

Table 5-4: Residential Unitary Air Conditioner Saturation by Region, 1993

Region	Installed Units* (Millions)	% of Total
Northeast	3.4	8.1
South	21.8	51.6
West	6.6	15.6
Midwest	10.4	24.7
Total U. S.	42.2	100.0

*Includes unitary air conditioners and air source heat pumps

5.4.1 Fault Trees

A set of 10 fault trees was developed to illustrate the potential scenarios for leaks of either pure HFC-32 or the blend. There are 9 main trees and 1 sub-tree, as listed in [Table 5-5](#), with a complete set attached in [Appendix C](#). Scenarios were developed by considering the location of the unit, the dispersion of the leak, and the potential sources of ignition. The main fault trees explore a hazard scenario. Where a branch of the main tree requires further development than can be accommodated on one tree, a sub-tree is developed. The rationale behind the data values assigned to each fault tree is discussed in the data table in [Appendix D](#). In addition, an overview of the reasoning and scenarios developed in each tree is described below.

Table 5-5: Fault Trees

Fault Tree	Description
1	Fire in a basement or garage
2	Fire in an attic
3	Fire in a closet
4	Fire within air handler
5	Fire in room due to leak into duct
6	Fire during servicing
6a -sub	Ignition due to serviceman smoking
7	Fire due to leak in wall void
8	Fire due to leak from outdoor condensing unit
9	Fire in room providing return air

FT1: Fire in Basement /Garage

[Fault Tree 1](#) considers a leak from an air handler installed in a basement or garage. We considered a leak from two locations: from within the air handler and from the inlet piping to the air handler. Leaks from these locations are considered separately because the size of the flammable envelope, and consequently the number of ignition sources encountered, will differ.

A flammable concentration from a leak within the air handler can only disperse into the room when the unit is idle or off. When the unit operates, the leak is rapidly dispersed to below flammable concentrations. We only considered catastrophic leaks from the air handler because concentration mapping tests by FMRC demonstrated that only a catastrophic leak forms a flammable concentration which penetrates into the room.

The ignition probability of both types of leaks was estimated by using an approach which considers only those ignition sources with sufficient energy to cause ignition, as determined by ignition testing at UL. The ignition sources considered are listed at the bottom of [Fault Tree 1](#). Estimates were then made of the fraction of time the ignition source would be present or on, and the probability that the refrigerant leak would encounter the source. This analysis was based on concentration mapping tests, ignition tests, and the unit's location.

FT2: Fire in Attic

An air handler can also be installed in an attic. A leak from a unit installed in the attic has been considered separately from the basement or garage because the likelihood of ignition differs. In a basement or garage there are a number of potential ignition sources associated with household activities (e.g., pilot for water heater, clothes dryer, furnace, etc.) However, in an attic, the likelihood of ignition is limited to the pilot from a water heater, and the much rarer chance of an electrical fault.

FT3: Fire in Closet

For an air handler installed in a closet, testing has shown that the dispersion of the leak is very different from a leak into an open room. The closed environment of a closet confines the leak and limits the dispersion. Testing has shown that a catastrophic leak from either the inlet piping or the air handler can form a flammable concentration within the closet. In addition the chance of ignition is far greater because the leak is likely to encounter almost all of the ignition sources within the closet.

FT4: Fire within Air Handler

[Fault Tree 4](#) considers a leak and ignition within the air handler. Only leaks from an air handler installed in a closet were considered, since tests at FMRC showed that a sustained flammable concentration was only achieved in the air handler for units installed in a closet. For air handlers installed in a less confined environment, like a basement or attic, a flammable concentration in the air handler occurs only momentarily.

The dispersion of a leak was considered during two distinct operating states; (i) with the unit on and the blower operating, and (ii) with the unit idle. Testing showed that with the blower operating, a detectable flammable concentration is never formed within the unit because the blower air movement encourages rapid dispersion. (A flammable concentration may be formed for a fraction of a second in a very small area, but it was not detected in testing and is not believed to constitute a significant risk.) A more likely scenario involves a leak while the unit is idle followed by start-up of the unit and ignition. In fact, testing by FMRC demonstrated that a flammable concentration forms within the air handler for several months. We assume the unit cycles between operational and idle modes every 15 minutes while switched on, and conservatively assume that any catastrophic leak during the idle period persists in a flammable concentration until the unit cycles on again. Potential ignition sources within the air handler include a high

voltage electrical spark from faulty electrical equipment or a failed (white hot) supplemental heater element.

FT5: Fire in Room Due to Leak into Duct

Fault Tree 5 investigates the potential for a leak from the air handler to disperse into a room via the duct system. When the unit is on and operating, the fan blower disperses air and any leaked refrigerant into the duct system. However concentration mapping by FMRC demonstrated that a flammable concentration is never achieved at the exit from the duct, and therefore, it is very unlikely a flammable composition of refrigerant could be formed in one of the rooms supplied with air conditioning. Originally, potential sources of ignition within typical rooms supplied with air conditioning (e.g., the kitchen, bedroom and living room) were considered. However, the probability of ignition of a leak in these rooms has not been quantified because a flammable concentration cannot reach these rooms.

FT6: Fire During Servicing

The potential for a fire during servicing was also considered. The first scenario considers ignition while brazing following incomplete refrigerant recovery. The second scenario considers the chance of a fire during a venting or charging process. While charging, a leak can occur if the hose is removed before the valve on the charging cylinder is closed; in addition, refrigerant initially charged into a system may be vented directly to atmosphere to flush impurities and air from the system. During venting, a flammable cloud of refrigerant could be formed if refrigerant is deliberately vented to atmosphere; this activity is in violation of regulations which require refrigerant recovery to a closed system. Even while venting to a closed container, a leak could occur if, for example, a connection is not fastened tightly.

Ignition by a match or lighter used by the service engineer in close proximity to the unit was considered. However, ignition by other outdoor sources is unlikely because testing has shown that a leak outside is rapidly dispersed. **Sub-tree 6a** considers the likelihood of ignition by a match during smoking.

The final scenario investigates the service contractor testing for leaks with a propane torch. Refrigerant leaks are currently detected by a variety of methods, including electronic and ultrasonic detectors. A propane torch is also a cheap and effective way to locate a leak, turning green upon location of a leak of a chlorine-containing refrigerant. Use of a propane torch to detect leaks on systems using flammable refrigerants should be discouraged through training and warning labels. Furthermore, a propane torch would not detect a leak of an HFC like HFC-32 since these refrigerants do not contain chlorine. However there is a chance that the service contractor will mistake the system as using a non-flammable chlorine-containing refrigerant, or will lack the proper equipment or the requisite training.

FT6a: Ignition Due to Serviceman Smoking

Sub-tree 6a considers the likelihood of ignition by a match during smoking. The chance that the service engineer is a smoker, ignores training about not smoking while servicing equipment, and actually smokes while servicing is considered. From the review of literature on methane ignition, we concluded that a cigarette cannot ignite methane, and thus would also not ignite HFC-32 or the blend. However, the match or lighter used with the cigarette could cause ignition if the leak reaches the match.

FT7: Fire Due to Leak in Wall Void

Fault Tree 7 considers the potential for ignition of a leak from the piping in the wall void. It was assumed that up to 10% of leaks can occur from the piping between the air handler and condensing unit, and most of this piping will be located in the wall void. It was also assumed that there is no ventilation within the wall to aid dispersion. The only potential ignition source is an electrical spark from faulty wiring inside the wall void. However, ignition testing by UL demonstrated that a very high voltage spark is required to cause ignition of HFC-32. Since a high voltage is not likely to occur in the wall void of a residence, the ignition probability is negligible.

FT8: Fire Due to Leak from Outdoor Condensing Unit

Fault Tree 8 considers the potential for ignition of a leak from the outdoor condensing unit. The first scenario investigates a fire caused by failure of the fusible plug on the compressor. Historically, the fusible plug has sometimes failed, and in a few cases, ignited the HCFC-22 refrigerant/lubricant mist. Since HCFC-22 is generally considered non-flammable except in very special circumstances, those fires probably resulted from ignition of the lubricant. HFC-32 requires a very high-energy ignition source, so we consider the probability of refrigerant ignition to be quite low with pure HFC-32 or the blend. The potential for lubricant ignition is beyond the scope of this study.

The second scenario considers ignition of leak within the condensing unit. Ignition of a leak outside the unit is not considered because testing has shown that a leak outside is rapidly dispersed. Only catastrophic leaks within the condensing unit were considered because slow leaks are unlikely to form flammable concentrations. Ignition within the unit could be caused by a high voltage spark (faulty wiring), or more likely by the compressor contactor at locked rotor condition.

FT9: Fire in Room Providing Return Air

This tree considers a fire in the room providing return air to the air handler. Typically return air is taken from a hallway, though it can be taken from a number of rooms. Return air intakes are considered from two types of systems (i) from an attic, basement or garage installation and (ii) from a closet installation.

Return air for a closet is most probably taken directly from the hallway where the closet is located. A leak from the air handler could therefore diffuse out of the unit, into the closet, and into the hallway. However, for a unit located in the attic, the return air duct

would typically link the air handler to the hallway through a diffuser located in the ceiling. With the unit idle or off, a leak of refrigerant could disperse down through the return air duct and into the hallway. However, concentration mapping by FMRC demonstrated that such a leak did not form a flammable concentration at the exit from the duct. For a unit located in the basement or garage, the return air duct would typically link the air handler to the hallway through a diffuser located in the lower part of a hallway wall. A leak of HFC-32 refrigerant would therefore have to travel up through the return duct to penetrate the hallway. Since HFC-32 is heavier than air, it is highly unlikely that HFC-32 refrigerant would reach the hallway.

5.4.2 Ignition Sources

The combustion of a gas-air mixture will only occur if the gas concentration is within a flammable range, and there is a suitable ignition source. If the gas concentration is either too dilute or too rich, a flame will not propagate, and combustion will be impossible. The minimum and maximum gas concentrations which will ignite in air are defined by the lower flammability limit (LFL) and the upper flammability limit (UFL). Thus, even with an ignition source present, there is a possibility that combustion may not occur.

A key element of the risk assessment is determining the likelihood of ignition of a release of refrigerant. Ignition probabilities are difficult to estimate, and for risk assessments of larger process units, such as a chemical plant, they are generally based on actual historical experience. Unfortunately, no such experience is available for flammable refrigerants. From the testing at UL, we gained a good understanding of the types of ignition sources likely to cause HFC-32 ignition. However, for ignition to occur, the ignition source must be on or present, the leak must reach the ignition source in a flammable concentration, and the ignition source must have sufficient energy to cause ignition.

For each scenario, a list of ignition sources was developed. Only sources with sufficient energy to cause ignition, based on the results of the ignition testing by UL, were considered. Estimates were then made of the fraction of time the ignition source would be present or on. The probability that the leak encounters the ignition source was based on concentration mapping results, the location of the unit, and the degree of confinement. The fault trees in [Appendix C](#) list the ignition sources considered for each scenario.

Estimated values for probability of ignition are listed in [Table 5-6](#). This shows that the probability of ignition of a leak from the inlet piping is greater than that of a leak from within the air handler, because the leak is likely to form a larger flammable envelope and encounter more ignition sources when it leaks directly into the room. A leak into a closet is more likely to ignite than a leak into the basement/garage or attic because testing has shown that the leak will encompass much of the lower portion of the closet and therefore has a high probability of encountering an ignition source if present. Ignition is least likely in the attic or hallway where the number of potential ignition sources is low.

Ignition of a leak within the condensing unit is more likely than a leak within the air handler. The most likely cause of ignition within the condensing unit is a high voltage spark generated by the compressor contactor at a locked rotor condition. However a leak within the air handler is likely to only be ignited by a high voltage spark from faulty wiring or from a failed heater element in white hot condition.

Table 5-6: Probability of Ignition

FT #	Description of leak and ignition	Probability of Ignition
1	Leak from air handler is ignited in basement/garage	5×10^{-4}
1	Leak from inlet piping in is ignited in basement/garage	3×10^{-3}
2	Leak from air handler is ignited in attic	4×10^{-4}
2	Leak from inlet piping in is ignited in attic	2×10^{-3}
3	Leak from air handler is ignited in closet	1×10^{-2}
3	Leak from inlet piping in is ignited in closet	2×10^{-2}
4	Leak ignited in air handler	1×10^{-4}
5	Leak from duct ignited in room	Negligible
7	Leak ignited in wall void	Negligible
8	Leak ignited within condensing unit	1×10^{-3}
9	Leak from air handler in closet ignited in hallway	1×10^{-4}

The probability of ignition in the wall space is negligible because the only potential ignition source is a low voltage spark from faulty wiring, which has insufficient energy to ignite HFC-32 or the blend. The probability of ignition in a room due to a refrigerant leak into the ductwork is also negligible because testing has shown that a flammable composition is never formed at the exit from the duct.

Ignition as a result of an independent fire has not been considered, even though this would obviously provide open flame and hot surface sources. The secondary effects from the refrigerant burning are likely to be small in comparison to the independent fire.

5.5 System Operation

Three distinct operating states were considered in this analysis because the operating state of the unit at the time of leakage can affect the dispersion of a leak, and in the case of the HFC-32/134a blend, the operating state can also affect the flammability of the refrigerant. The three operating states considered are listed below. No distinction was made between operating in the heating or cooling modes since the chance of a release and effects following a release are not substantially different.

- Switched off or in an idle state, i.e., unit is switched on but not operating.
- System is on and operating.
- Unit is being serviced (i.e., switched off, except temporarily)

5.6 Servicing

Through discussions with service technicians employed by heat pump manufacturers and independent servicing agencies, an understanding was gained of current work practices in the US for repairing air conditioning systems. This included discussions about testing for leaks, venting refrigerants, and charging refrigerant into the unit.

Currently, if refrigerant pressure is low within the unit, the service technician will recharge the system up to a pressure of 1 bar gage (14.7 psi). A leak can be detected by a variety of methods including an electronic leak detector, an ultrasonic detector, soapy liquid, or a propane flame. The latter method is the oldest technique, and is the least safe option. However, since it does not require purchase of expensive equipment and is an effective technique to detect leaks of refrigerants containing chlorine, it is still likely to be in common use, particularly by small service agencies often used to service domestic appliances. Leak detection practices must be designed to ensure they do not present an ignition source to a leaking system using flammable refrigerants. Some effort will therefore be needed to discourage dangerous practices and reduce errors when servicing HFC-32 units, for example through guidelines and training. In particular, repair by unauthorized or untrained service technicians should be discouraged.

Removal of refrigerant from the system may be required in a number of instances. For example, any brazing activity requires the refrigerant pressure to be reduced because atmospheric pressure is required for effective and safe brazing. Some other repair work, such as replacement of a valve or filter/drier, may also require refrigerant removal.

Current U.S. regulations forbid intentional venting of refrigerants, whether flammable or not, directly to atmosphere. Only “de-minimus,” releases, such as purging hose connections, are permitted. A vacuum pump is normally used to transfer refrigerant to a closed container. However, this prohibition may occasionally be disregarded, particularly by smaller operators often employed to service residential units. Venting to a closed system requires purchase of expensive equipment certified by the EPA, and requires more time for completion. The meaning of “de-minimus releases” may also occasionally be stretched by some technicians in order to save time.

6. Discussion of Results

The values estimated for the likelihood of a fire in various regions are indicated in [Table 6-1](#). Since installation environments differ regionally, [Table 6-1](#) lists fire frequencies separately by region. As explained previously in [Table 5-4](#), the air handler is often installed in the utility closet and rarely in the basement/garage in the South or West, while in the Northeast, utility closet installations are rare. In the Midwest, we assume the air handler is equally likely to be installed in any location. Multiplying the fire frequencies in [Table 6-1](#) by the number of installed units from [Table 5-4](#) gives the total estimated number of fires by region, which is shown in [Table 6-2](#).

Table 6-1: Fire Frequencies

Description of Leak and Ignition Scenario	Frequency of Fire- Northeast (fires/unit/yr.)	Frequency of Fire- South (fires/unit/yr.)	Frequency of Fire- West (fires/unit/yr.)	Frequency of Fire- Midwest (fires/unit/yr.)
FT1: Fire in basement/garage	8.9×10^{-8}	5.2×10^{-9}	5.2×10^{-9}	3.5×10^{-8}
FT2: Fire in attic	8.2×10^{-9}	3.7×10^{-8}	3.7×10^{-8}	2.7×10^{-8}
FT3: Fire in utility closet	9.5×10^{-8}	9.5×10^{-7}	9.5×10^{-7}	6.3×10^{-7}
FT4: Fire within air handler	2.2×10^{-10}	2.2×10^{-9}	2.2×10^{-9}	1.5×10^{-9}
FT5: Fire in room due to leak into duct	0	0	0	0
FT6: Fire due to servicing	2.6×10^{-6}	2.6×10^{-6}	2.6×10^{-6}	2.6×10^{-6}
FT7: Fire due to leak in piping in wall	0	0	0	0
FT8: Fire due to leak in condensing unit	3.2×10^{-7}	3.2×10^{-7}	3.2×10^{-7}	3.2×10^{-7}
FT9: Fire in room providing return air	9×10^{-10}	9×10^{-9}	9×10^{-9}	5.9×10^{-9}
Total for Service	2.6×10^{-6}	2.6×10^{-6}	2.6×10^{-6}	2.6×10^{-6}
Total for Operation (excluding service)	5.2×10^{-7}	1.3×10^{-6}	1.3×10^{-6}	1.0×10^{-6}
Grand Total	3.1×10^{-6}	3.9×10^{-6}	3.9×10^{-6}	3.6×10^{-6}

Table 6-2: Estimated Number of Fires by Region

Description	Fires/Year - Northeast	Fires/Year - South	Fires/Year - West	Fires/Year - Midwest	Fires/Year - Total U. S.
Service Fires	9	57	17	27	110
Fires from Operation	2	28	9	10	49
All fires	11	85	26	37	159

[Table 6-1](#) shows that the highest likelihood of fire occurs during servicing ([Fault Tree 6](#)), estimated to have a frequency of 2.6×10^{-6} fires/unit/year. This is not surprising since servicing activities will often involve removal and recharging of refrigerant, where the likelihood of a refrigerant release is much increased. Although intentional release of refrigerant to atmosphere is prohibited in the US, there is a chance that guidelines will be ignored or that an accidental release will occur. Another potential cause of a fire during servicing would be misuse of a propane torch to detect a leak (see [Fault Tree 6](#)).

The likelihood of a fire within the condensing unit ([Fault Tree 8](#)) is also significant at around 3×10^{-7} fires/unit/year. The main ignition source is sparking from the compressor contactor at locked rotor condition. Ignition testing by UL showed that sparks from high amperage contactors could ignite HFC-32 under certain conditions.

The likelihood of a fire for a unit installed in the basement/garage, attic or closet is listed in [Fault Trees 1 to 3](#). These frequencies are a combination of the likelihood of ignition of a release and the probability of the air handler being installed in that particular location. For example, the frequency for a fire in the closet is an order of magnitude higher in the South or West than in the Northeast because many more units are installed in closets in the South and West.

For a true comparison of the likelihood of ignition in different installation environments, figures for [Fault Trees 1 to 3](#) in the Midwest, where it is assumed that the unit is equally likely to be installed in the basement/garage, attic and utility closet, should be compared. While a leak into the attic is least likely to cause a fire, a leak into the closet is most likely to result in a fire. Since ignition sources within the attic are more limited than in other locations, the frequency of a fire is reduced. In contrast, a leak into a confined closet will tend to encompass the entire lower section of the closet and therefore encounter any ignition source present, such as a water heater pilot light.

[Table 6-2](#) shows that the total number of fires that might occur if the entire installed base of HCFC-22 units was replaced by HFC-32 units is less than 200 per year. As expected, the total number of fires would be greatest in the South, reflecting both the larger installed base and the likelihood of a utility closet installation. Conversely, the number of fires in the Northeast is lowest because of the smaller installed base and the distribution of installation locations.

Overall, the risk of fire resulting from use of HFC-32 is about 1 per million units/year for operation and about 3 per million units/year for service. It should be emphasized that the grand total of about 4 fires per million units/year is significantly less than the risk which might be expected from use of a more flammable refrigerant such as propane, because propane is more flammable than HFC-32 and may be ignited by a wider variety of sources with lower ignition energies.

The risk of fire for the HFC-32/134a (30/70 wt. %) blend is slightly lower than that for HFC-32, but this difference is difficult to assess precisely. While HFC-32 is flammable under any likely climatic condition, HFC-32/134a is only flammable under certain conditions. However, the measured CFR of the blend differs according to the laboratory and exact test procedure used. Taking a conservative CFR value of about 40/60 weight percent, there could be a flammable vapor in equilibrium with the liquid under most temperature conditions. During operation, the blend would be well mixed, and the refrigerant would be non-flammable, but during idle or off states, there could be a leak of flammable concentration. Furthermore, there were only a few ignition sources tested by UL that ignited HFC-32 but did not ignite the worst case fractionated blend.

The air conditioner or heat pump would operate with the compressor on for about 10-30% of the year, depending on climate, and there would be no fire risk with the blend during operation, except at startup. This would reduce the overall fire risk accordingly.

Furthermore, considering the likelihood that the CFR of the blend under real world conditions is higher than 40/60 wt. %, we would estimate that the fire risk from either servicing or operation would decrease another 10-20% from the values for HFC-32. Therefore, the total risks for the blend would be about 2.2×10^{-6} fires/unit/year for service and between 3.4×10^{-7} and 6.5×10^{-7} fires/unit/year for operation. This yields an estimated total number of fires per year in the U.S. of about 126 (94 from service and 32 from operation) if all HCFC-22 systems were converted to the blend. This risk is about 20% lower than the figure for HFC-32.

7. Risk Mitigation

Risk mitigation can be accomplished by preventing leaks or preventing the ignition of leaks. The following sections discuss four potential risk mitigation methods, and the associated reduction in risk.

7.1 Improved Training of Service Personnel

Significant reduction in risk can be achieved by comprehensive training of service personnel, with particular emphasis on training smaller operators who might otherwise use unsafe techniques. Campaigns to raise awareness of the increased risk with flammable refrigerants would also help to reduce the practice of dangerous procedures; for example, use of a propane torch to detect leaks.

If we assume comprehensive training and awareness campaigns have been completed, we can estimate that the chance that a service contractor lacks training or ignores the risks associated with flammable refrigerants would be reduced from 1 chance in 20 to 1 in 100. The risk during servicing would therefore decrease from 2.6×10^{-6} /year to 5.9×10^{-7} /year.

7.2 Redesign Condensing Unit Electronics

The compressor contactor is an unlikely, but credible, ignition source in the condensing unit. Moving it or using a sealed contactor that can not ignite the refrigerant would reduce the probability of ignition in the outdoor unit from 3.2×10^{-7} /year to 1.4×10^{-7} /year. Redesign of the fusible plug on the compressor to prevent failure and consequent ignition would reduce the risk further.

7.3 Leak Reduction

One of the most obvious ways to reduce fires due to the use of a flammable refrigerant is to reduce the frequency of leaks. Most leaks occur at heat exchanger joints, so attention should be focused on factory brazing techniques. The industry has been working on improvement of brazing techniques for several years, due to the adverse impact of refrigerant leakage on system performance and warranty costs, and leak frequencies will probably continue to decline in the future. The proposed use of high-pressure refrigerants makes improvement of joint integrity an important issue for the industry, even if non-flammable refrigerants are used. If we assume a reasonable reduction in leak frequency by a factor of 5, we can expect a reduction in risk by about a factor of 5 in most operation scenarios.

7.4 Changes to Building Codes

If flammable refrigerants are used, changes to building codes and regulations could help to mitigate the risk of fire. The most useful change would be to prohibit the installation of a gas or oil-fired appliance such as a water heater in the same utility closet as the air handler. Such a change would reduce the probability of ignition in a closet ([Fault Tree 3](#)) to a negligible value.

8. Historical Fire Risks

In order to put the risks of HFC-32 air conditioners and heat pumps in perspective, it is useful to compare fire and fatality data for currently used heating and cooling equipment. Although the available data is incomplete, it is clear that the additional predicted risks posed by HFC-32 air conditioners are significantly less than those currently encountered with traditional heating and cooling equipment or other household appliances.

8.1 U.S.

According to the U.S. National Safety Council, there were an average of 518,300 home fires in the US annually during the years from 1986-1990, and 22 %, or approximately 114,000, were caused by “heating systems.” [2] The fires due to heating systems caused about 630 civilian deaths. “Heating systems” (primarily gas and oil furnaces and portable heaters) is the reporting category most similar in scope to the air conditioning/heat pump systems studied in this risk assessment, the other categories including smoking materials, cooking equipment, electrical distribution system, etc. Approximately 42 million of the total 96.6 million US households have a central air conditioning system (of which about 11.9 million have a heat pump). [1, 17] As discussed in Section 6, we would expect less than 200 additional fires per year if the entire installed base of HCFC-22 units were replaced by HFC-32 systems. With mitigation in place, the rates would be even lower. The additional risk due to HFC-32 would therefore be orders of magnitude below the 114,000 fires per year (1.2×10^{-3} fires/unit/year) currently caused by heating systems.

A comparison of the risks of HFC-32 air conditioning systems with those associated with other recognized, but unlikely, hazards is also useful. For example, U.S. data for 1993 indicates that the chance of death from a lightning strike is roughly 3×10^{-7} /year per individual, resulting in about 75 deaths each year in the population of 250 million. [2] The risk of fires due to use of HFC-32 in air conditioners is about one order of magnitude higher, but most of those fires would not result in deaths.

8.2 U.K.

U.K. fire data divides causes of fires somewhat more precisely than U.S. data. Statistics for 1993 are shown in Table 8-1. [18] Once again, it is clear that the predicted additional incremental risks from the use of HFC-32 in unitary air conditioners are orders of magnitude lower, even without mitigation.

Table 8-1: Fire Frequencies in the U.K.

Appliance	Fire Frequency (fires/dwelling/year)
Cooking Appliances	1×10^{-3}
Space Heating Appliances	2×10^{-4}
Central and Water Heating Appliances	5×10^{-5}
Refrigerators	2×10^{-5}
All Other Electrical (excluding refrigerators)	4×10^{-4}

9. References

1. Energy Information Administration, U.S. Department of Energy, *Housing Characteristics 1993*, DOE-EIA-0314(93), June 1995.
2. U.S. National Safety Council. *Accident Facts*. 1993.
3. United Nations Environment Program, Refrigeration, Air Conditioning and Heat Pumps Technical Options Committee, *Montreal Protocol 1991 Assessment*, December 1991.
4. Alternative Fluorocarbons Environmental Acceptability Study (AFEAS), U.S. Department of Energy, *Energy and Global Warming Impacts of Not-In-Kind and Next Generation CFC and HCFC Alternatives*, 1994.
5. Air Conditioning and Refrigeration Technology Institute, Refrigerant Database, Version 1.29, ARTI, December, 1997.
6. ASHRAE, *ANSI/ASHRAE Standard 34-1992, Number Designation and Safety Classification of Refrigerants*, Atlanta, Georgia: American Society of Heating, Refrigerating, and Air Conditioning Engineers, 1992.
7. ASTM, *ASTM Standard E681-85, Standard Test Method for Concentration Limits of Flammability of Chemicals*, Philadelphia, Pennsylvania: American Society for Testing and Materials, 1985.
8. Arthur D. Little, Inc. *Risk Assessment of Flammable Refrigerants for Use in Home Appliances*, Report prepared for the Environmental Protection Division of Global Change, September, 1991.
9. Kakutani, M., et. al., *Study on Explosion Limit of HFC-32 and Air Mixtures*, Proceedings of the 34th High Pressure Discussion Group in Tokyo, November 17-19, 1993.
10. Huber, M.L., et.al., *REFPROP Version 4.0*, NIST, Gaithersburg, MD, 1993.
11. Dekleva, T. et al., Flammability and Reactivity of Select HFCs and Mixtures, *ASHRAE Journal*. Atlanta, Georgia: ASHRAE. December, 1993.
12. Ohnishi, H., et al. 1993. "Relation between flammability and composition ratio of blend HFC-32/HFC-134a." *Proceedings of the 1993 NIST/ASHRAE Conference*. Atlanta, Georgia: ASHRAE. August 20.
13. DuPont Corporation, *ASHRAE SSPC34 Classification of DuPont SUVA AC9000*, May 18, 1994.
14. Lees, F., *Loss Prevention in the Process Industries*, Butterworths, London, 1980.
15. Scilly, N., *The Blast Effect of Explosions, International Symposium on Loss Prevention and Safety Promotion in the Process Industries*, Cannes, 1987.
16. Heinonen, E., et. al., *Methods Development for Measuring and Classifying Flammability and Combustibility of Refrigerants, Final Report Task 3- Laboratory Test Results*, Center for Global Environmental Technologies, New Mexico Engineering Research Institute, December 1994.
17. 1996 Statistical Profile of the Air-Conditioning, Refrigeration, and Heating Industry, Air Conditioning and Refrigeration Institute, Arlington, VA, 1996.
18. United Kingdom Home Office, United Kingdom *Fire Statistics 1993*, 1995.

10. Appendix A: UL Report on Small Scale Testing



May 27, 1997

Arthur D. Little Inc.
Mr. William J. Goetzler
Consultant
Acorn Park
Cambridge, MA 02140-2390

Our Reference: 97NK5683, NC2523

Subject: Flammability Testing of Refrigerants 32 and 32/134a -
ARTI Refrigerant Testing Proposal, Part 1, Task 2 and Task 3

Dear Mr. Goetzler:

This letter is our Final Report covering the flammability testing conducted on both refrigerants R32 and R32/134a, 60/40 percent by weight. Reference is made to our previous letters of May 13, 1996, July 1, 1996, January 17, 1997 and February 4, 1997 which contain information relating to the original proposal.

This Report includes the following:

- I. Summary of Findings
- II. Identification of Refrigerants Tested
- III. Test Method Details
- IV. Test Results
- V. Ignition Source Code Summary
- VI. Details of "IV. Test Results" Table Column Headings
- VII. Observations

333 Pfingsten Road
Northbrook, Illinois 60062-2096
(847) 272-8800
FAX No. (847) 272-8129
MCI Mail No. 254-3343
Telex No. 6502543343



I. S U M M A R Y O F F I N D I N G S

The following summarizes the findings of the tests conducted. The [table](#) which follows provides additional details.

Refrigerants R32 and R32/134a (60/40% weight) can be ignited by various sources such as a high voltage arc, an abnormally hot wire (broken envelope light bulb, abnormally hot heater element), an open flame (burning match, propane pilot light, butane pilot light) and a compressor contactor breaking a 240 V abnormal high current. In addition, Refrigerant R32 can be ignited by a 120 V or 240 V abnormally high current electric spark. A wall switch, motors, an electric drill, a halogen light bulb, a low voltage arc and a 120 V normal load current electric spark did not ignite Refrigerant R32.

IGNITION SOURCE (IGNITION SOURCE CODE)	Results			
	Refrigerant R32		Refrigerant R32/R134a (60/40% Wt.)	
	Ignition Y/N	Test No(s)	Ignition Y/N	Test No(s)
Electric Arc - High Voltage(A1) (A2)	Y	(6-9,42)	Y	(102,103)
Electric Arc - Low Voltage(A3)	N	(43,44)	-	
Electric Spark across loose wires				
(240 V, 96 A, 42 PF) (A4A)	Y	(77,78)	N	(119,120)
(120 V, 72 A, 50 PF) (A4B)	Y	(79,80)	N	(126)
(120 V, 16 A, 75-80 PF) (A4C)	N	(81,87,88)	-	
Heater Element - Normal operating temperature (H1) (H4)	N	(10,11)	N	(115,116)
Red hot - abnormal temperature (H3) (H4)	N	(14,16,17)	N	(115,116)
Very hot(white)- failure temp.(H3) (H4) (H2A)	Y	(15,33,34)	Y	(108,109)
Hot Wire Ignitor (H2) (H2A)	N	(12,13)	N	(111-114)
Light bulb with envelope broke (B1) (B3)	Y	(18,19)	Y	(106,107)
Halogen light bulb - normal operation (B2)	N	(45-49,73)	-	
Match - wooden type (M)	Y	(21,23)	Y	(104,105)
Open flame - propane (F2)	Y	(26,27)	Y	(111,112)
Open flame - natural gas (F1)	Y	(24,25)	Y	(113,114)
Motor - totally enclosed type (R2)	N	(52,54-56)	-	
- open type (M1)	N	(50,51)	-	
- electric drill with brushes (M3)	N	(31,32)	-	
On/Off wall switch - 120 V, 72 A, 40-50 PF (S1A)	N	(35,36)	-	
(15 A, 120 V) 120 V, 15.2 A tungsten (S1B)	N	(37,38,39)	-	
On/Off wall switch - 240 V, 96 A, 40-50 PF (S2)	N	(40,41)	-	
(20 A, 120-277 V ac)				
Contactor (rated 30/35 FLA) 240 V, 96 A, 42 PF (C1A) (C2A)	Y*	(62-65)	Y***	(121,122)
242 V, 35 A, 77 PF (C2B) (C1B) (C1C)	Y**	(70-72)	N	(123-125)
Contactor (rated 40 FLA) 240 V, 96 A, 42 PF (C3)	N	(66,67)	-	
Contactor (rated ½ hp) 244 V, 29.5 A, 47 PF (C4)	N	(74,75)	-	

* - Ignition on 1st, 7th, 16th and 20th cycles - for 4 tests.
 ** - Ignition only after many cycles.
 *** - Ignition on 4th, 5th cycle - for 2 tests.

II. I D E N T I F I C A T I O N O F R E F R I G E R A N T S T E S T E D

The gas chromatograph test was used to compare the R32 refrigerant used for the ignition tests which were submitted by A. D. Little to R32 refrigerant available at UL and also to verify the percent by weights of the R32/134a blend used for the ignition tests.

GAS CHROMATOGRAPHY

<u>Test No.</u>	<u>Refrigerant</u>	<u>Result</u>
1	R32	Matched R32 available at UL
2	R32/134a	60.93/39.06% by weight
3	R32/134a	60.20/38.80% by weight

Test No. 2 - Before ignition testing

Test No. 3 - After ignition testing

The ratio of the R32/134a refrigerant used for the ignition tests changed less than 1 percent during the testing.

III. T E S T M E T H O D D E T A I L S

All tests were conducted in a test chamber with inside dimensions of 1 ft by 1 ft by 1 ft. The test chamber was constructed from 3/4 in. thick plywood for the bottom, back, right side and left side and from 1/2 in. plastic for the front and 11/64 in. thick plastic for the top except [Test No. 82](#) through [Test No. 88](#) which used 3/4 in. thick plywood for the top. All joints fitted closely together and were sealed with RTV and/or tape except for the top which rested on the sides and was used for pressure relief.

A 3 in. diameter muffin fan was installed in the test chamber and used for mixing the refrigerant. The fan was an Nidec Nidec-Torn ALPHAU TA300 Model A30475-10, 230 V ac, 0.060/0.025 A, 50/60 Hz impedance protected. The fan was energized at 60 Hz, 120 V for all tests.

The mixing fan was energized prior to all tests to mix the refrigerant and air since the Arc A1 (used to demonstrate that a flammable mixture was present) could not be conveniently located at the same height as the ignition source for all tests. The 230 V fan was energized at 120 V to provide mixing and prevent stratification of the refrigerant/air mixture in the test chamber without influencing the results. The fan caused no visible turbulence of the flame during any ignition. The fan did affect the temperature (by color of sources) of some hot wire ignition sources, for example the defrost heater element and heater element as noted in the test results.

The temperature and humidity in the test chamber were measured by a Vaisala Model HM131 humidity and temperature indicator serial No. R4320014 with a humidity range of 0 to 100 percent, a temperature measuring range of -4 to 199°F and a temperature operating range of 41 to 131°F.

The temperature of the mixture in the test chamber was found to be acceptable and was not adjusted for any of the tests.

The humidity in the test area was found to be low, approximately 8 to 20 percent relative humidity. The room compressed air used to purge the box of the by-products of combustion was approximately 20 percent relative humidity. The humidity of the test air was increased by pumping humid air from a separate humidity chamber into the test chamber.

The area under a large test platform was walled off with plastic sheeting and a humidifier was installed and energized. A plastic tubing was inserted in the area and connected through an air pump to a valve on the test chamber.

By energizing the air pump and opening the valve on the humidity chamber, humid air (near 100 percent relative humidity) could be injected into the test chamber. It was found during the initial tests that the humidity had to be raised in the test chamber to over 80 percent before the refrigerant was added in order for the humidity to be near 50 percent during the ignition testing. After several ignitions of the refrigerant it was found that very little humid air needed to be added to the test chamber for each test. After

many ignitions of the refrigerant, it was found that no humid air needed to be added and the humidity would frequently climb above the desired 50 percent level. Apparently, the wooden test chamber initially absorbed the moisture from the air; however, after several tests, the wood apparently would release moisture into the air.

The wood of the test chamber also retained some of the by-products of combustion. The corrosive by-products of the combustion were being released by the wood and would effect the humidity sensor in the humidity and temperature indicator and caused the device to at first respond slowly, then start to read a higher humidity than was present and within a short time caused the device not to function properly, reading over 100 percent in the test chamber. Two of the humidity sensors of the humidity and temperature indicator failed during the testing.

Although the corrosive by-products of combustion damaged and ultimately destroyed the humidity sensors, it did not appear to effect the temperature indicator or have any effect on the outcome of any subsequent test.

The testing was conducted in a large laboratory facility kept at a negative pressure in relation to the remainder of the building. The test chamber was on a table under an exhaust hood which had a 3200 cfm capacity. Sidewalls were constructed around the rear, right side, left side, and on the right and left side of the front to direct all by-products of combustion resulting from the tests into the exhaust hood. The hood discharged the by-products of combustion from the tests to the atmosphere. UL applied for and received permission from the IEPA to discharge the by-products of combustion from the tests into the atmosphere. UL conducted smoke bomb tests to verify that all by-products of combustion were removed from the area under the hood and did not escape into the laboratory environment.

The engineer conducting the tests wore safety glasses, a lab coat and gloves and used a positive pressure breathing mask when approaching the test enclosure after ignition had occurred.

The tests were conducted by first installing the desired ignition source or sources in the test chamber and testing the ignition source for proper operation, if possible, before the introduction of the refrigerant. The air in the test chamber was then thoroughly purged of all by-products of combustion from previous tests. The mixing fan in the test chamber would then be energized and the cover of the test enclosure installed. The temperature and humidity of the air would then be measured and adjustments made to increase the humidity as necessary by energizing the humid air pump and opening the valve to the test enclosure. When it was determined that the air in the test enclosure had the proper humidity and temperature, the humid air pump would be deenergized and the valve closed. The mixing fan would then be deenergized and the predetermined amount of refrigerant would be added to the test chamber. The mixing fan would then be energized and the temperature and relative humidity of the mixture would then be measured by the humidity and temperature indicator. The instrument would then be removed and the hole sealed with the rubber stopper.

Because the ignition sources were at various heights in the test enclosure, it was decided to conduct all tests with the mixing fan energized prior to the attempted ignition of the mixture. Ignition was then attempted and if the mixture did not ignite, ignition would then be attempted by using the "standard" arc indicated as A1 in the attached [table](#), to show that the mixture in the box was flammable.

After the test, compressed air was then injected into the test chamber through a solenoid with a copper tube with holes located at the bottom rear of the test chamber. The cover was removed and the test chamber purged of all by-products of combustion.

The refrigerant was added to the test chamber by the following method. For pure R32, the refrigerant was stored in small vessels. The refrigerant vessel valve was opened and the refrigerant was allowed to flow into a 1000 ml plastic syringe at approximately room temperature and at atmospheric pressure. The valve to the refrigerant bottle was then closed and the valve to the test chamber was opened. The refrigerant was injected slowly into the bottom of the test chamber. This was repeated until the total amount of refrigerant desired was injected into the test chamber.

For the R32/134a mixture, UL mixed 14.4 lb of R32 and 9.6 lb of R134a in a 30 lb cylinder (liquid cylinder). The refrigerants were then mixed and a small amount was removed for the GC test. The liquid cylinder was connected to an evacuated 30 lb cylinder (gas cylinder) which was connected to the 1000 ml syringe. Pressure gauges were attached to both the gas cylinder and the liquid cylinder. The valves were opened for a short time to allow a small amount of the R32/134a (60/40) blend liquid to flow into the gas cylinder and allowed to evaporate completely. This was determined by noting that the pressure in the gas cylinder never was above 30 psig whereas the pressure in the liquid cylinder was approximately 180 psig. The gas in the gas cylinder was then allowed to flow into the 1000 ml syringe at atmospheric temperature and pressure and was then injected into the test chamber for the test. At the conclusion of the tests, a small amount of liquid was removed from the liquid cylinder to determine how fractionation may have varied the ratio of the R32 and R134a refrigerants in the liquid state during the testing.

IV. T E S T R E S U L T S

The following provides details of the test results obtained.

Tests 1 through 88 were conducted using R32 and Tests 101 through 126 were conducted using R32/134a (60/40 percent).

Tests 1 through 75 were conducted first followed by Tests 101 through 125 followed by tests 76 through 81 followed by test 126 followed by Test Nos. 82 through 88.

A. Refrigerant R32 100%, Tests 1-88

Test No.	Refrig. Amt. CC	Test Chamber	Test Air- Temp. °F/ RH	Mixing Fan On	Ignition Source Type	Ignition Y/N	Arc A1 Ignition Y/N	Notes
1	1000	1 ft ³	74/62	Y	A1	N	-	
2	2000	1 ft ³	74/54	Y	A1	N	-	
3	3000	1 ft ³	74/51	Y	A1	N	-	
4	3500	1 ft ³	74/49	Y	A1	N	-	Slight burning around arc
5	4000	1 ft ³	75/51	Y	A1	N	-	Slight burning around arc
6	4500	1 ft ³	75/51	Y	A1	Y	-	Blue flame - low press.
7	5000	1 ft ³	77/60	Y	A1	Y	-	Blue flame - low press.
8	5500	1 ft ³	76/60	Y	A1	Y	-	Blue flame - low press.
9	6000	1 ft ³	75/56	Y	A1	Y	-	Blue flame - more press.
10	6000	1 ft ³	75/53	Y	H1	N	Y	Bright red hot wire did not ignite mixture.
11	6000	1 ft ³	82/50	Y	H1	N	-	-
12	6000	1 ft ³	78/48	Y	H2	N	Y	Bright red hot wire did not ignite mixture.
13	6000	1 ft ³	73/44	Y	H2	N	-	-
14	6000	1 ft ³	79/52	Y	H3	N	Y	Bright red hot wire did not ignite mixture.
15	6000	1 ft ³	74/55	Y/N	H3	Y	-	Mixture did not ignite with mixing fan on - turned the mixing fan off and element got very red (white) and ignited mixture.
16	6000	1 ft ³	80/63	Y/N	H3	N	-	Very hot element did not ignite mixture. Enclosure cover warped due to heat of element during the test.

Test No.	Refrig. Amt. CC	Test Chamber	Test Air- Temp. °F/ RH	Mixing Fan On	Ignition Source Type	Ignition Y/N	Arc A1 Ignition Y/N	Notes
17	6000	1 ft ³	86/47	Y/N	H3	N	-	Very hot element did not ignite mixture. Enclosure cover warped due to heat of element during the test.
18	6000	1 ft ³	81/45	Y	B1	Y	-	Instant ignition
19	6000	1 ft ³	78/53	Y	B1	Y	-	Instant ignition (Not on video tape)
20	6000	1 ft ³	74/46	Y	M	-	-	Match did not ignite
21	6000	1 ft ³	74/50	Y	M	Y	-	Blue flame low pressure
22	6000	1 ft ³	74/61	Y	M	-	-	Match did not ignite
23	6000	1 ft ³	74/52	Y	M	Y	-	Blue flame low pressure
24	6000	1 ft ³	74/48	Y	F1	Y	-	Blue flame when natural gas ignited
25	6000	1 ft ³	73/52	Y	F1	Y	-	Blue flame when natural gas ignited
26	6000	1 ft ³	74/56	Y	F2	Y	-	Blue flame when propane gas ignited
27	6000	1 ft ³	76/62	Y	F2	Y	-	Blue flame when propane gas ignited
28	6000	1 ft ³	74/51	Y	M3	N	N	Burning across arc - no ignition
29	6000	1 ft ³	75/53	Y	M3	N	N	Slight burning across arc - no ignition
30	6000	1 ft ³	76/60	Y	A1	Y	-	Big blue flame
31	7000	1 ft ³	76/54	Y	M3	N	Y	Big blue flame
32	7000	1 ft ³	76/58	Y	M3	N	Y	Big blue flame

Test No.	Refrig. Amt. CC	Test Chamber	Test Air-Temp. °F/ RH	Mixing Fan On	Ignition Source Type	Ignition Y/N	Arc A1 Ignition Y/N	Notes
33	7000	1 ft ³	81/54	Y/N	H4	Y	-	Big blue flame (mixing fan off) - Heater element sagging and may ground if tested again in the same position (limit control positioned up) (Limit control may not have functioned - see Tests 115 and 116)
34	7000	1 ft ³	77/58	Y/N	H4	Y	-	Ignition (mixing fan off) before heater cycled on the limit control (limit control positioned down). (limit control may not have functioned - see Tests 115 and 116)
35	7000	1 ft ³	74/40	Y	S1A	N	Y	Did not ignite - 14 cycles with switch load of 120 V, 72 A PF 40-50%.
36	7000	1 ft ³	74/60	Y	S1A	N	Y	Did not ignite - 23 cycles with switch load of 120 V, 72 A, PF 40-50%. Could see arcing at switch.
37	7000	1 ft ³	73/-	Y	S1B	N	Y	Did not ignite - 10 cycles with switch load of 120 V, 15.2 A tungsten load (2000 W light bulbs)
(Note - Reading changed from 55% to 78% when refrigerant added. Humidity reading in question. Humidity sensor instrument checked and not working properly at this point.)								
38	7000	1 ft ³	74/-	Y	S1B	N	N	Did not ignite - 10 cycles with switch load. Slight burning at arc.
39	7000	1 ft ³	72/-	Y	S1B	N	Y	Did not ignite - 10 cycles with switch load. Blue flame after arc.

Test No.	Refrig. Amt. CC	Test Chamber	Test Air- Temp. °F/ RH	Mixing Fan On	Ignition Source Type	Ignition Y/N	Arc A1 Ignition Y/N	Notes
40	7000	1 ft ³	72/-	Y	S2	N	Y	No ignition - 10 cycles with switch load of 238.7 V 96.3 A 42 PF Blue flame with arc.
41	7000	1 ft ³	72/-	Y	S2	N	Y	Same load as test 40. No ignition - 14 cycles with switch load. Blue flame with arc
42	7000	1 ft ³	72/-	Y	A2	Y	-	-
43	7000	1 ft ³	72/-	Y	A3	N	-	-
44	7000	1 ft ³	72/-	Y	A3	N	Y	Ignition with A1 Arc. Not with A3 Arc.
(Changed humidity sensor at this point.)								
45	7000	1 ft ³	73/45	Y	B2	N	Y	Light on 45 sec. Ignition with Arc.
46	7000	1 ft ³	75/38	Y/N	B2	N	Y	Light on 60 sec. Mixing fan off for test.
47	7000	1 ft ³	72/45	Y	B2	N	N	Light on 60 sec. Burning around Arc. No ignition.
48	7000	1 ft ³	74/48	Y	B2	N	N	Light on 60 sec. Burning around Arc. No ignition.
49	8000	1 ft ³	74/49	Y	B2	N	Y	Light on 60 sec. Mixing fan on for test.
50	7000	1 ft ³	73/50	Y	M1	N	N	-
51	8000	1 ft ³	73/48	Y	M1	N	Y	Soft blue flame - low pressure.
52	8000	1 ft ³	73/52	Y	M2	N	N	Slight burning at Arc.

Test No.	Refrig. Amt. CC	Test Chamber	Test Air- Temp. °F/ RH	Mixing Fan On	Ignition Source Type	Ignition Y/N	Arc A1 Ignition Y/N	Notes
53	8000	1 ft ³	73/59	Y	A1	Y	-	Soft blue flame.
54	8000	1 ft ³	75/56	Y	M2	N	N	-
(Readjusted Arc electrodes at this point.)								
55	8000	1 ft ³	74/46	Y	M2	N	N	Slight burning around Arc - No ignition.
56	8000	1 ft ³	73/47	Y	M2	N	Y	Soft blue flame with Arc.
57	6000	1 ft ³	72/64	Y	A1	N	-	Burning at Arc - No ignition
58	7000	1 ft ³	72/51	Y	A1	Y	-	Blue flame
59	8000	1 ft ³	73/45	Y	C1A	N	N	Did not ignite with 15 cycles. Burning around Arc. No ignition.
(Resealed enclosure and changed box lid at this point.)								
60	8000	1 ft ³	72/51	Y	C1A	N	Y	7 cycles with C1A. No ignition. Blue w/orange flame with Arc.
61	7000	1 ft ³	74/73	Y	C1A	N	Y	15 cycles with C1A. No ignition. Big Blue flame with Arc.
62	7000	1 ft ³	73/62	Y	C2A	Y	-	Ignition on 7th Arc. Big blue flame.
63	7000	1 ft ³	73/54	Y	C2A	Y	-	Ignition on 16th Arc. Big blue flame.
64	7000	1 ft ³	74/56	Y	C1A	Y	-	Ignition 1st Arc.
65	7000	1 ft ³	73/52	Y	C1A	Y	-	Ignition 20th Arc.
66	7000	1 ft ³	73/50	Y	C3	N	Y	37 cycles with C3. No ignition. Blue flame with Arc.

Test No.	Refrig. Amt. CC	Test Chamber	Test Air- Temp. °F/ RH	Mixing Fan On	Ignition Source Type	Ignition Y/N	Arc A1 Ignition Y/N	Notes
67	7000	1 ft ³	74/60	Y	C3	N	Y	83 cycles with C3. No ignition. Blue flame with Arc.
68	7000	1 ft ³	72/48	Y	C2B	N	Y	63 cycles with C2B - No ignition.
69	7000	1 ft ³	73/57	Y	C2B	N	Y	71 cycles with C2B - No ignition.
70	7000	1 ft ³	72/38	Y	C1B	Y	-	Ignition on 44th Arc
71	7000	1 ft ³	72/55	Y	C1B	Y	-	Ignition on 25th Arc
72	7000	1 ft ³	72/60	Y	C1B	Y	-	40 slow cycles - No ignition. Ignition on 84th fast cycles (124th cycle).
73	7000	1 ft ³	72/57	Y/N	B2	N	Y	3/4 min with mixing fan on and 3/4 min with mixing fan off. No ignition with light.
74	7000	1 ft ³	73/61	Y	C4	N	Y	110 cycles - No ignition. Ignition with Arc.
75	7000	1 ft ³	73/63	Y	C4	N	Y	155 cycles - No ignition. Ignition with Arc.
(Note - Tests 76 to 81 conducted after Test 125.)								
76	7000	1 ft ³	73/90	Y	A4A	N	N	Box cork left out during filling. Some burning around Arc A4A.
77	7000	1 ft ³	73/83	Y	A4A	Y	-	Big blue flame.

(Humidity sensor stopped working at this point.)

Test No.	Refrig. Amt. CC	Test Chamber	Test Air- Temp. °F/ RH	Mixing Fan On	Ignition Source Type	Ignition Y/N	Arc A1 Ignition Y/N	Notes
78	7000	1 ft ³	73/-	Y	A4A	Y	-	Big blue flame.
79(78)+	7000	1 ft ³	73/-	Y	A4B	Y	-	Big blue flame.
80(79)+	7000	1 ft ³	73/-	Y	A4B	Y	-	Big blue flame.
81(80)+	7000	1 ft ³	73/-	Y	A4C	N	N	About 4 sparks from ignition source A4C before cover jarred loose - No ignition.

(Note - Tests 82 to 88 conducted after Test 126.)
 (Changed humidity sensor at this point.)

82	7000	1 ft ³	72/17	Y	A1	Y	-	Blue flame
83	7000	1 ft ³	73/51	Y	A1	Y	-	Soft Blue flame
(Taped cover down for Test No. 84.)								
84	7000	1 ft ³	74/37	Y	A1	N	-	Some burning around Arc

(Changed to wood cover for test enclosure for Test Nos. 85-88.)

85	7000	1 ft ³	73/36	Y	A1	Y	-	Strong blue flame
86	7000	1 ft ³	74/46	Y	A1	Y	-	Strong blue flame
87	7000	1 ft ³	74/52	Y	A4C	N	Y	Blue flame with arc
88	7000	1 ft ³	74/52	Y	A4C	N	Y	Blue flame with arc

(+) - The numbers in parenthesis are the numbers used on video tape.

B. Refrigerant R32/134a (60/40%) Tests 101-126 -

Test No.	Refrig. Amt. CC	Test Chamber	Test Air-Temp. °F/ RH	Mixing Fan On	Ignition Source Type	Ignition Y/N	Arc A1 Ignition Y/N	Notes
101	5000	1 ft ³	73/51	Y	A1	N	N	Burning around arc No ignition.
102	6000	1 ft ³	74/55	Y	A1	Y	-	Soft Burn
(Changed humidity sensor at this point.)								
103	7000	1 ft ³	73/66	Y	A1	Y	-	Soft Burn - Orange Flame on top - blue on bottom.
104	7000	1 ft ³	73/65	Y	M	Y	-	Blue flame top of enclosure.
105	7000	1 ft ³	73/57	Y	M	Y	-	Blue flame top of enclosure.
106	7000	1 ft ³	72/44	Y	B3	Y	-	Blue to orange flame
107	7000	1 ft ³	73/57	Y	B3	Y	-	Blue to orange flame
108	7000	1 ft ³	73/49	Y	H2A	Y	-	Blue to orange flame
109	7000	1 ft ³	73/69	Y	H2A	Y	-	Blue to orange flame
110	7000	1 ft ³	73/74	Y	H2B/F2	Y	-	Blue to orange flame Ignition caused by either H2B or F2.
111	7000	1 ft ³	72/43	Y	H2B/F2	Y	-	Pilot light ignition
(Transformer used to power H2A and H2B burned out and changed back to transformer used for H2.)								
112	7000*	1 ft ³	73/79	Y	H2A/F2	Y	-	Pilot light ignition
113	7000	1 ft ³	74/49	Y	H2A/F1	Y	-	Pilot light ignition
114	7000	1 ft ³	73/68	Y	H2A/F1	Y	-	Pilot light ignition

Test No.	Refrig. Amt. CC	Test Chamber	Test Temp. °F/ RH	Air- Mixing Fan On	Ignition Source Type	Ignition Y/N	Arc A1 Ignition Y/N	Notes
115	7000	1 ft ³	75/52	Y	H4	N	N	Limit control down. Heater cycled off and did not cycle back on.
116	7000	1 ft ³	75/44	Y	H4	N	Y	Limit control up. Limit cycled off - Ignition with arc (Not on video tape)
117	7000	1 ft ³	72/30	Y	A4A+	N	Y	Orange flame with Arc
118	7000	1 ft ³	73/88	Y	A4A+	N	Y	Blue flame with Arc (Not on video tape)
119	7000	1 ft ³	74/81	Y	A4A	N	Y	Blue flame wi
120	7000	1 ft ³	74/86	Y	A4A	N	Y	-
121	7000	1 ft ³	73/61	Y	C1A	Y	-	Ignition on 4
122	7000	1 ft ³	73/73	Y	C1A	Y	-	Ignition on 5
123	7000	1 ft ³	72/52	Y	C1C	N	N	200 cycles. No ignition.
124	7000	1 ft ³	72/49	Y	C1C	N	Y	100 cycles. No ignition.
(Humidity meter slow to respond at this point.)						Ignition with Arc		
125	7000	1 ft ³	73/83	Y	C1C	N	Y	150 cycles. No ignition Ignition with
(Note - Test 126 conducted after Test 81.)								
126	7000	1 ft ³	73/-	Y	A4B	N	N	About 3 sparks from ignition source before enclos cover jarred No ignition.

* - Rubber stopper left out of side of box during filling of refrigerant.
 + - No spark from ignition source.

V. I G N I T I O N S O U R C E C O D E S U M M A R Y

The following identifies the code designation used for specific ignition sources of the test program.

Code	Ignition Source	Specifications	Test Volts/Amp	Notes
A1	Arc	Franceformer Cat. No. 15030P 120 V Primary	15,000 V Secondary	High Voltage Arc
A2	Arc	Carlin Combustion 120 V Primary	17,000 V Secondary Peak	Type used in oil-fired residential furnace
A3	Arc	Robertshaw Model SP845	Input 24 V	Type used for gas-fired furnace
A4A	Arc	Wires touching	#240 V, 96 A 42 PF	Loose wires
A4B	Arc	Wires touching	*120 V, 72 A 50 PF	Loose wires
A4C	Arc	Wires touching	120 V, 16 A 75-80 PF	Loose wires
H1	Heater Element##	120 V rated	Tested at 140 V maximum	Edison Base Type
H2	Hot Wire Ignitor	120 V rated	Tested at 140 V maximum	Used for gas and oil-fired furnace and gas hot water heater and dryers
H2A	Hot Wire Ignitor	120 V rated	Tested at 120 V	Same as H2 except readjusted wire
H2B	Hot Wire Ignitor	120 V rated	Tested at 90 V to 120 V	Same as H2 except readjusted wire
H3	Broken glass defrost heater element	120 V rated	Tested at 140 V maximum	

Code	Ignition Source	Specifications	Test Volts/Amp	Notes
H4	Heater f element	3260 W, 240 V (12 A)	Tested at 240 w/o air flow	Represent fan failure condition. Heater element limit control operating in circuit.
B1	Light bulb with envelope removed	120 V rated 52 W	Tested at 120 V	
B2	Halogen light bulb	500 Watt 120 V	120 V	Open halogen light bulb.
B3	Light bulb with envelope removed	120 V rated 100 W	120 V	
M	Burning match	Strike anywhere Ohio Blue Tip wooden match	-	
S1A	On/Off Switch	Eagle 15 A 120 V ac only	*+120 V 72 A 40-50% PF	Mounted in open 2 in. by 4 in. junction box. Largest locked rotor motor load.
S1B	On/Off Switch	Same as S1A	*120 V 15.2 A tungsten light bulb load	Mounted in open 2 in. by 4 in. junction box. Largest light bulb load.
S2	On/Off Switch	Crouse-Hinds 20 A 120-277 V ac only	#+240 V 96 A 42 PF	Mounted in open 2 in. by 4 in. junction box. Largest locked rotor motor load.
F1	Natural Gas	Natural gas	-	Pilot light - natural gas - furnace, clothes dryer, hot water heater
F2	Propane Gas	Propane gas	-	Pilot light

Code	Ignition Source	Specifications	Test Volts/Amp	Notes
M3	Electric Drill	Sears Craftsman 3/8 in. drill variable speed double insulated 1/5 hp - 1200 rpm Model 315.11430 110-120 V, 60 Hz, AC only 2.2 Amp	120 V	Power tool with brush motor
M1	Evaporator Blow Motor	6E Model 5KCP39PGS082S 208-230 V, 5.4 A, 3/4 hp. 1-phase, 60 Hz Open frame.	240 V	Tested on high speed. Represents open frame. Evaporator blower motor
M2	Condenser Fan Motor	GE Model 5KCP39FGN809BS 208-230 V, 1.4 A, 1-phase 1/4 hp, 60 Hz. Totally enclosed.	240 V	Represents totally enclosed condenser fan motor.
C1A	Compressor Contactor	Essex Type 112DBAB Rated 277 V 35 FLA, 150 LRA 24 V coil, SPNO	+240 V, 96 A, 42 PF	Locked rotor load current.
C1B	Compressor Contactor	Same as CIA	+242 V 35.3 A 77.5 PF	Full load current
C1C	Compressor Contactor	Same as CIA	+240 V, 35 A, 76 PF	Full load current
C2A	Compressor Contactor	Honeywell R8243A1353 Rated 277 V, 30 AFL, 150 ALR, 24 V coil SPNO	+240 V 96 A, 42 PF	Locked rotor load current.

Code	Ignition Source	Specifications	Test Volts/Amp	Notes
C2B	Compressor Contactor	Same as C2A	+242 V, 35.3 A 77.5 PF	Full load current.
C3	Compressor Contactor	GE CR353ADY34H Rated 240 V, 40 FLA, 240 LRA, 24 V coil DPNO	+240 V 96 A, 42 PF	Wire SPNO with top cap off
C4	Evaporator Motor Contactor	Essex Model 91-102000-29000 rated 1/2 hp, 125/250 V, 60 Hz, 24 V coil. SPNO	+244 V 29.5 A 47 PF	Locked rotor load current.

f - Type used as primary or second source of spacing heating in residential or light commercial dwelling.

- Type used in some portable electric heaters (not now in common use) and would represent and be hotter than the presently used portable electric heaters.

+ - Inductive load used. Designated "UL Murry" - Manufactured by Gus Berthold Electric Co.

Tests with the "UL Murry" as the load have a random closing (energizing) during the testing. The machine is not designed to close at the highest current of the alternating current cycle. Several test cycles would need to be completed to obtain the highest current.

In addition, the contacts would be heated each cycle (conducting and breaking of the load current). After several cycles the contacts would reach higher temperatures and presumably pitting of the contacts would increase the chances of small areas of the contacts reaching very hot temperatures.

Contactors would not normally be subjected to rapid repeated cycles in a heat pump.

* - Typical wall switch is rated 15 A, 125 V. The largest normal light bulb type load would be 15 A tungsten light bulb load.

The largest motor load would be 12 A (80% of 15 A) at a PF of 75-80% representing a normal running motor and 72 A (6 x FLA) at a PF of 40-50% representing an abnormal locked rotor motor.

- Heavy duty switch is rated 20 A, 120-277 V ac.

The largest motor load would be 16 A (80% of 20) at a PF of 75-80% representing a normal running motor and 96 A (6 x FLA) at a PF of 40-50% representing an abnormal locked rotor motor.

VI. D E T A I L S O F " I V. T E S T R E S U L T S " T A B L E

C O L U M N H E A D I N G S:

The following provides details of the column headings used in the Test Results Table of Section IV above.

Test No. - Number Assigned to Test, For Reference Purpose.

Refrig. Amt. CC - Volume of refrigerant used in the test in cubic centimeters.

Test Chamber - One cubic foot box used for each test.

Test Air-Temp. °F/RH - The temperature in °F and the relative humidity of the refrigerant/air mixture in the test chamber before attempted ignition.

Mixing Fan On - The mixing fan was energized for each test as noted. In some cases the mixing fan was turned off during the testing as noted.

Ignition Source Type - Types of the ignition source as specified in the "IGNITION SOURCE SUMMARY."

Ignition Y/N - Y = yes, N = no. Indicating if ignition occurred using the ignition source.

Arc A1 Ignition Y/N - If ignition did not occur with the primary ignition source, ignition would then be attempted with the "arc A1" ignition source, Y - yes, N = no if ignition occurred.

Notes - As noted for each test.

VII. OBSERVATIONS

The following provides the type of observations along with details.

VIDEO TAPE

The testing was recorded on videotape. Copies of the tapes were furnished for your reference.

PRESSURE GENERATED

It was noted that little pressure was generated as a result of the ignitions. The rubber stopper used to close the hole used for the probe of the humidity and temperature indicator was never forced out of the opening as a result of the ignition. The cover was raised slightly off of the chamber during some ignitions, however, never more than about one inch high and the cover was never dislodged from the chamber as was noted during testing with propane and propane/butane mixtures. The R32 appeared to generate slightly more pressure than the R32/R134a mixture.

From previous experience, the energy released and pressure generated during an ignition event is highly dependent on the geometry of the device, the mixing conditions and other variables. Tests previously conducted on pure R32 in the Westerberg explosion test vessel indicated that pure R32 has considerably lower ignition pressure than that of a propane/butane mixture.

Previous tests have been conducted in the test chamber with propane and a propane/butane mixture. Both generated significantly more pressure than the R32 and the R32/R134a mixture. The propane and propane/butane mixture did not appear to be very explosive when tested in the test chamber, however, the propane/butane mixture was very explosive when tested in a refrigerator. True measurements of pressure would need to be conducted in a sealed container, for example in the UL Westerberg explosion test vessel comparing R32 and the R32/134a blend to other flammable mixtures such as propane. It is felt that measuring pressure in an unsealed container such as the test chamber would be misleading. Pressures should be measured in the large scale tests.

- - - - -

In no event shall Underwriters Laboratories be responsible to anyone for whatever use or nonuse is made of the information contained in this Report and in no event shall Underwriters Laboratories, its employees, or its agents incur any obligation or liability for damages, including but not limited to, consequential damages arising out of or in connection with the use, or inability to use, the information contained in the report.

Page 23
May 27, 1997
97\18Sester.Feb lsd

Information conveyed by this Report applies only to the specimens actually involved in the test. UL has not established a factory Follow-Up Service Program to determine the conformance of subsequently produced material, nor has any provision been established to apply any Registered Mark of UL to such material.

The issuance of this Report in no way implies Listing, Classification, or Recognition by UL and does not authorize the use of UL Listing, Classification or Recognition Marks or any other reference to UL on or in conjunction with the product or system.

Refrigerant R32 was provided by Arthur D. Little Inc. (supplied by Factory Mutual) and Refrigerant 134a was supplied from UL's stock at Arthur D. Little's request. Underwriters Laboratories Inc. did not select these samples. The results apply only to the samples tested.

The cylinder with the R32 refrigerant and our cylinder with the R32/R134a blend was sent to Arthur D. Little Inc. as you requested.

This letter completes the work planned under the Project 97NK5683 and also closes this project.

If you have any questions or comments, please feel free to contact the writer at our Northbrook address.

Very truly yours,



ROGER W. SESTERHENN (Ext. 42610)
Staff Engineer
Engineering Services 415B

Reviewed by:



IZZY SAVITZKY
Associate Managing Engineer
Engineering Services 415B

RWS:lsd
97/18Sester.feb

11. Appendix B: FMRC Report on Large-Scale Testing

TECHNICAL REPORT

LARGE-SCALE FLAMMABILITY TESTS FOR RISK ASSESSMENT OF A2 REFRIGERANTS IN A SPLIT SYSTEM RESIDENTIAL HEAT PUMP[®]

By:

M. M. Khan

J. L. Chaffee

Prepared for:

Arthur D. Little, Inc.

20 Acorn Park

Cambridge, MA 02140-2390

April 1998

FACTORY MUTUAL



TECHNICAL REPORT

LARGE SCALE FLAMMABILITY TESTS FOR RISK ASSESSMENT OF A2
REFRIGERANTS IN A SPLIT SYSTEM RESIDENTIAL HEAT PUMP

by

M. M. Khan
J. L. Chaffee

Prepared for:

Arthur D. Little, Inc.
20 Acorn Park
Cambridge, Massachusetts 02140-2390

FMRC J.I. 0D0R7.MT

April 1998

Approved by:

©1998 Factory Mutual Research
Corporation.



Factory Mutual Research

1151 Boston-Providence Turnpike
P.O. Box 9102
Norwood, Massachusetts 02062

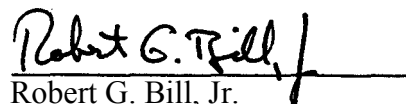
Robert G. Bill, Jr.
Director,
Materials Research

DISCLAIMER

Reference to specific testing products is not and should not be construed as opinion, evaluation or judgment by Factory Mutual Research Corporation (FMRC). FMRC (a) makes no warranty, express or implied, with respect to any products referenced in this report, or with respect to their use, and (b) assumes no liabilities with respect to any products referenced in this report, or with respect to their use.

EXECUTIVE SUMMARY

The objective of this project was to evaluate the dispersion and ignition characteristics of R-32 and a blend of R-32/R-134a (60%/40% by weight) refrigerants for likely leak scenarios expected to be encountered in a split system residential heat pump. In the study, two series of realistic scale tests have been conducted using catastrophic (fast) and slow release rates of refrigerants. The first series of tests consisted of concentration mapping of various leak scenarios to characterize the size, location and the dynamic behavior of the flammable zone. The second series involved ignition tests, performed by placing ignition sources in locations where flammable concentrations were found to occur. The ignition sources were 15 kV arcs and propane pilot flames.

The tests were carried out in the Factory Mutual Research Corporation (FMRC) 63.7-m³ (2250-ft³) Test Chamber, located at the FM Test Center in West Gloucester, Rhode Island. The test chamber was configured to represent several leak scenarios, such as leak into a room (in a quiescent environment), to the outdoors, in the indoor air handler coil (which spreads to the duct and to the room through the diffuser if the blower is on), and into a utility closet.

Concentration profiles of flammable gases due to the release of refrigerant were measured at 12 locations with a Total Hydrocarbon Analyzer, Model EA-700, Eagle Systems. The instrument was calibrated using known concentrations of R-32 and 60%/40% by weight blend of R-32/R-134a in N₂.

The concentration mapping and ignition tests were conducted at fast as well as slow leaking rates. The fast leaking rate was a two-phase release at approximately 2000-3000 g/min (4.4 – 6.6 lb/min) until a full charge of approximately 5.5 kg (12.1 lb) of refrigerant was depleted. The slow leak ~100 g/min (0.22 lb/min) was a vapor release of the entire charge of approximately 5.5 kg (12.1 lb). The amount of refrigerant release in the tests corresponded to the approximate charge of R-32 required for a high efficiency 5-ton heat pump. The slow leak attempted to simulate a leak caused by a tube failure from vibration or rubbing. The fast or catastrophic leak rate simulated a complete line break.

Most of the concentration mapping tests were performed with R-32, with a few blend tests to allow difference in behavior to be observed. The ignition tests were conducted only with R-32. All tests were performed at chamber temperatures of 27-32°C (80-90° F) with a relative humidity of 60-70%.

The test results are summarized below:

1. The slow leak of R-32 into a room produced flammable concentration greater than the lower flammable limit (LFL), which is 13% by volume, at elevations of 0.076 m (3 in.) and up to 0.305 m (12 in.) as far as 2.44 m (8 ft) away from the refrigerant release point. While no ignitions were observed by placing propane pilots in the flammable regions, ignition occurred using a strong electrical source, such as 15 kV arc igniter.
2. The fast leak of R-32 into a room generated refrigerant concentrations well below the LFL in the same regions as stated above and no ignitions were observed by using three propane pilots placed in different locations.
3. The fast leak of R-32 in the air handler with the blower on produced concentrations at the locations inside the air handler, in the supply duct and away from the diffuser above the floor, significantly lower than the LFL.
4. The fast leak of R-32 in the air handler enclosed in a closet (with blower off) produced momentarily flammable concentrations inside the closet which then dropped below the LFL. The concentration outside the closet 0.152 m (6 in.) above the floor, however, remained above the LFL. A brief ignition was observed inside the closet from the gas pilots placed at the locations 0.076 m (3 in.) above the floor. However, at the location outside the closet 0.305m (1 ft) away and 0.076 m (3 in.) above the floor, sustained flames developed around the arc igniter and around the gas pilot (in two separate tests using each igniter at a time).
5. Fast and slow leaks of R-32 into a duct (simulating a leak inside the duct, which spreads to the room through the diffuser) did not produce ignitions with three 15 kV arc igniters placed directly below, 0.457 m (18 in.) and 0.864 m (34 in.) away from the duct diffuser.
6. The outdoor leak was simulated by releasing R-32 refrigerant into the room at a slow rate with air blowing at $0.017 \text{ m}^3/\text{s}$ (36 CFM) from a fan, 0.076 m (3 in.) in diameter aimed at the release point. The dilution of the leak by the flow of air kept the concentrations below the LFL, at elevations 0.152 m (6 in.) to 0.914 m (3 ft) and distances 0.305 m (1 ft), 1.22 m (4 ft) and 2.44 m (8 ft) away from the release point.
7. The fast leak of R-32/R-134a blend (60%/40% by weight) into the air handler unit inside a closet (with blower off) produced concentrations as high as 20-25% at various locations inside the air handler, in the closet and outside the closet above the floor.

8. Under similar conditions as above, the same blend in a slow leak produced concentrations up to 10%.

ACKNOWLEDGMENTS

The authors wish to gratefully acknowledge the following persons who contributed to this project:

Dr. Franco Tamanini, of FMRC, for his valuable insight and helpful suggestions; Mr. Rick Jambor of FMRC for his generous help in this program, especially for designing the refrigerant release systems; and Mr. Bill Goetzler of Arthur D. Little, Inc., for his support and program guidance.

TABLE OF CONTENTS

<u>Section</u>	<u>Title</u>	<u>Page</u>
	EXECUTIVE SUMMARY	i
	ACKNOWLEDGMENTS	iv
I	INTRODUCTION	1
II	FACILITIES AND EQUIPMENT	3
	2.1 TEST ENCLOSURE	3
	2.2 REFRIGERANT INJECTION SYSTEMS	6
	2.1.1 Slow Release	6
	2.2.2 Fast Release	6
	2.3 CONCENTRATION MAPPING MEASUREMENT SYSTEM	8
III	TESTS AND RESULTS	10
	3.1 CONCENTRATION MAPPING TESTS	10
	3.1.1 Test Configurations	10
	3.1.1.1 Leak into a Room	10
	3.1.1.2 Outdoor Leak	12
	3.1.1.3 Leak in the A-coil of the Air Handler Unit	12
	3.1.1.4 Leak in the A-coil of the Air Handler Unit inside A Closet	15
	3.1.2 Concentration Mapping Test Sequence	15
	3.1.3 Concentration Mapping Test Results	17
	3.1.3.1 Room Leak	17
	3.1.3.2 Outdoor Leak	20
	3.1.3.3 Leak in Air Handler Unit	20
	3.1.3.4 Leak in Air Handler Unit inside a Closet	26
	3.2 IGNITION TESTS	
	3.2.1 Ignition Test Sequence	34
	3.2.2 Test Configurations and Results	35
	3.2.2.1 Leak in Air Handler Unit Inside a Closet	35
	3.2.2.2 Leak into a Room	37
	3.2.2.3 Leak in the Duct	39

3.2.2.4	Room Leak with Obstacle	39
IV	CONCLUSIONS	44
	REFERENCES	46

LIST OF FIGURES

<u>Figure</u>	<u>Title</u>	<u>Page</u>
1	FMRC 63.7 m ³ (2250 ft ³) Test Chamber	4
2	FMRC 63.7 m ³ (2250 ft ³) Test Chamber (Plan View)	5
3	Refrigerant Injection System	7
4	Calibration Curves for Total Hydrocarbon Analyzer. Model EA-700, Eagle Systems.	9
5	Gas Sampling Layout for Room Leak Test	11
6	Release Location and Gas Sampling Locations for Fast and Slow Refrigerant Releases in Air Handler (Blower Off)	13
7	Release Location and Gas Sampling Locations for Fast-Release in Air Handler (Blower On: at 900 CFM)	14
8	Release and Gas Sampling Locations for Refrigerant Release in Air Handler Inside the Closet	16
9a.	Concentrations of R-32 (Fast Release) as a Function of Time at Various Locations and Elevations on the Pan	18
9b.	Concentrations of R-32 (Fast Release) as a Function of Time at Various Locations and Elevations on the Pan	19
10a.	Concentrations of R-32 (Slow Release) as a Function of Time at Various Locations and Elevations on the Pan	21
10b.	Concentrations of R-32 (Slow Release) as a Function of Time at Various Locations and Elevations on the Pan. (Test conducted for extended period of time)	22
11	Concentrations of R-32 (Slow Release: simulation of outdoor release) as a Function of Time at Various Locations and Elevations on the Pan	23
12a.	Concentrations of R-32 (Slow Release into the Air handler with Blower Off) as a Function of Time at Various Locations Inside and Outside the Air Handler.	24
12b.	Concentrations of R-32 (Fast Release into the Air Handler with Blower Off) as a Function of Time at Various Locations Inside and Outside the Air Handler.	25

13a.	Concentrations of R-32 (Fast Release into the Air handler with Blower On) as a Function of Time at Various Locations of Gas Sampling	27
13b.	Concentrations of R-32 (Fast Release into the Air handler with Blower On) as a Function of Time at Various Locations of gas Sampling (Repeat Test)	28
14a.	Concentrations of 60% / 40% of R-32/R-134a (Fast Release into the Air Handler Inside a Closet) at Various Locations Inside the Air Handler, in the Closet and Outside the Closet above the Floor.	29
14b.	Concentrations of 60% / 40% of R-32/R-134a (Fast Release into the Air Handler Inside a Closet) at Various Locations Inside the Air Handler, in the Closet and Outside the Closet above the Floor.	30
15	Concentrations of 60% / 40% of R-32/R-134a (Slow Release into the Air Handler Inside a Closet) at Various Locations Inside the Air Handler, in the Closet and Outside the Closet above the Floor	31
16a.	Concentrations of R-32 (Fast Release into the Air handler Inside A Closet) at Various Locations Inside the Air Handler, in the Closet and Outside the Closet above the Floor	32
16b.	Concentrations of R-32 (Fast Release into the Air Handler Inside a Closet) at Various Locations Inside the Air handler, in the Closet and Outside the Closet above the Floor	33
17	Release and Igniters Locations for Releases in Air Handler Inside a Closet	36
18	Release Point and Igniters Locations for Pan Ignition Tests	38
19a.	Release Point and Igniters Locations – Duct Release Test (Elevation – Looking North)	40
19b.	Igniters Locations for Duct release (Plan View)	41
20	Release Point and Igniters Locations: Pan Ignition Test with an Obstacle	42

LIST OF TABLES

Table	Title	Page
I	Flammability Characteristics of Some Selected Refrigerants	1

I

INTRODUCTION

The overall objective of this project was to evaluate the risk associated with the use of R-32 (Difluoromethane, CH₂F₂) and a blend of R-32 and R-134a (1,1,1,2-Tetrafluoroethane, CH₂FCF₃) refrigerants in a split system residential heat pump. This project was awarded to Arthur D. Little, Inc. (ADL) by the Air Conditioning and Refrigeration Technology Institute (ARTI). The objective of the part of the project performed by Factory Mutual Research Corporation (FMRC) for ADL was to carry out realistic scale tests for likely leak scenarios of these two refrigerants into a duct, a heat pump air handler, a room, a utility closet and to the outside. The purpose of the tests was to evaluate the dispersion characteristics and the ignitability of the release in the volume affected by the release.

R-32 is classified as an A2 (lower or moderately flammable) refrigerant by ASHRAE Standard 34 (Ref. 1). While R-134a is classified as an A1 (non flame propagating), the blend of R-32 and R-134a is not yet classified. A conservative value of the worst-case fractionated blend for R-32/R-134a is 60%/40% by weight. This would probably be classified as A1/A2. The “worst case of fractionation” is defined (Ref. 1) as the composition during fractionation that results in the highest concentration of the flammable component(s) in the vapor or liquid phase. In terms of flammability characteristics, [Table I](#) indicates that R-32 and R-134a are significantly less flammable than other commonly mentioned refrigerants, such as R-152a and propane. Data in [Table I](#) are taken from Ref. 2-4.

Table I. Flammability Characteristics of Some Selected Refrigerants

Refrigerant	Molecular Weight	Lower Flammable Limit (% vol.)	Upper Flammable Limit (% vol.)	Heat of Combustion (MJ/kg)
R-134a 1,1,1,2-Tetrafluoroethane, CH ₂ FCF ₃	102.02	None	None	4.2
R-32 Difluoromethane, CH ₂ F ₂	52.02	12.7	33.4	9.4
R-152a 1,1-Difluoroethane, CH ₃ CHF ₂	66.05	4.8	16.9	17.4
R-290, Propane (Dimethylmethane), C ₃ H ₈	44.10	2.1	11.2	50.3

The flammability of a refrigerant released into air is dependent on various factors, such as the rate of the flow of refrigerant through the leak (leak size, pressure), fast two-phase release (catastrophic failure) or slow vapor release, total amount of refrigerant released, ambient air flow conditions, temperature and relative humidity, dimension of the enclosure containing the refrigerant, location of ignition source(s) and ignition source(s) strengths, etc. A systematic series of tests at a realistic scale is thus necessary to characterize the ignition behavior of refrigerant releases that are representative of some reasonable worst-case accident scenarios.

In this study, two series of tests have been conducted using catastrophic (fast) and slow release rates of refrigerants. The first series of tests consisted of concentration mapping of various leak scenarios to characterize the size, location and the dynamic behavior of the flammable zone. This was followed by a series of ignition tests which placed ignition sources in locations where flammable concentrations were found to occur.

All the tests in this program were designed according to ADL's specifications in order to help assess the risk associated with the use of A2 refrigerants in a split system residential heat pump.

II

FACILITIES AND EQUIPMENT

2.1 Test Enclosure

The tests were carried out in the FMRC 63.7-m³ (2250-ft³) Test Chamber, as shown in [Figure 1](#), located at the Factory Mutual Test Center (FMTC) in West Gloucester, Rhode Island. This facility has been used extensively for vented gas and dust explosion experiments and is designed to withstand pressures up to about 0.7 barg (10 psig). The overall dimensions of the chamber are 4.5 by 4.5 by 3 m, (15 by 15 by 10 ft) high. The chamber has two reinforced doors that are used to seal it during testing. Also, the chamber has a 2.36 m³/s (5000 cfm) roof exhaustor (ventilator), as shown in [Figure 2](#), which is rail-mounted to allow for moving the unit from the vent opening that is normally covered with a plywood sheet during each test. The roof exhaustor is moved back in position after each test. Two video cameras, one on the north wall and the other on the east wall of the chamber are normally installed to record the events during a test from two different angles. The chamber is outfitted with air cannons that are charged with carbon dioxide before each test. These air cannons are discharged, if necessary, to extinguish any sustained fire within the test chamber.

Within the chamber, the setup consists of a 2.74 by 2.74 by 0.61 m deep (9 by 9 by 2 ft deep) aluminum pan (as shown in [Fig. 2](#)) that can be used to contain the spill for room tests. All simulated room tests were conducted using this aluminum pan, as agreed by ADL. The pan area is about 36% of the total floor area of the chamber. One side of the pan (the north side) is made of Lexan (rather than aluminum) in order to allow events deep in the pan to be recorded by the video camera. The chamber is equipped with an air heater to raise the ambient temperature within the chamber to almost any desired level. Also installed in the chamber is a humidifier consisting of an immersion heater in a water reservoir and a circulating fan to allow for reasonably rapid elevation of the humidity within the chamber. The relative humidity condition within the chamber is monitored with a Dew Point Hygrometer attached to a sampling line located at the center of the pan and 2.34 m (7 ft, 8 in.) above the floor of the pan. In order to monitor the pressure inside the chamber during ignition tests, a pressure transducer is installed on the east side of the chamber. There are several gas sampling lines and thermocouples located at various elevations above the pan.

A Carrier FC4A-070 air handling unit was installed on the chamber floor approximately one foot from the wall of the chamber. The air handler was connected to 0.305 by 0.61 m (1 by

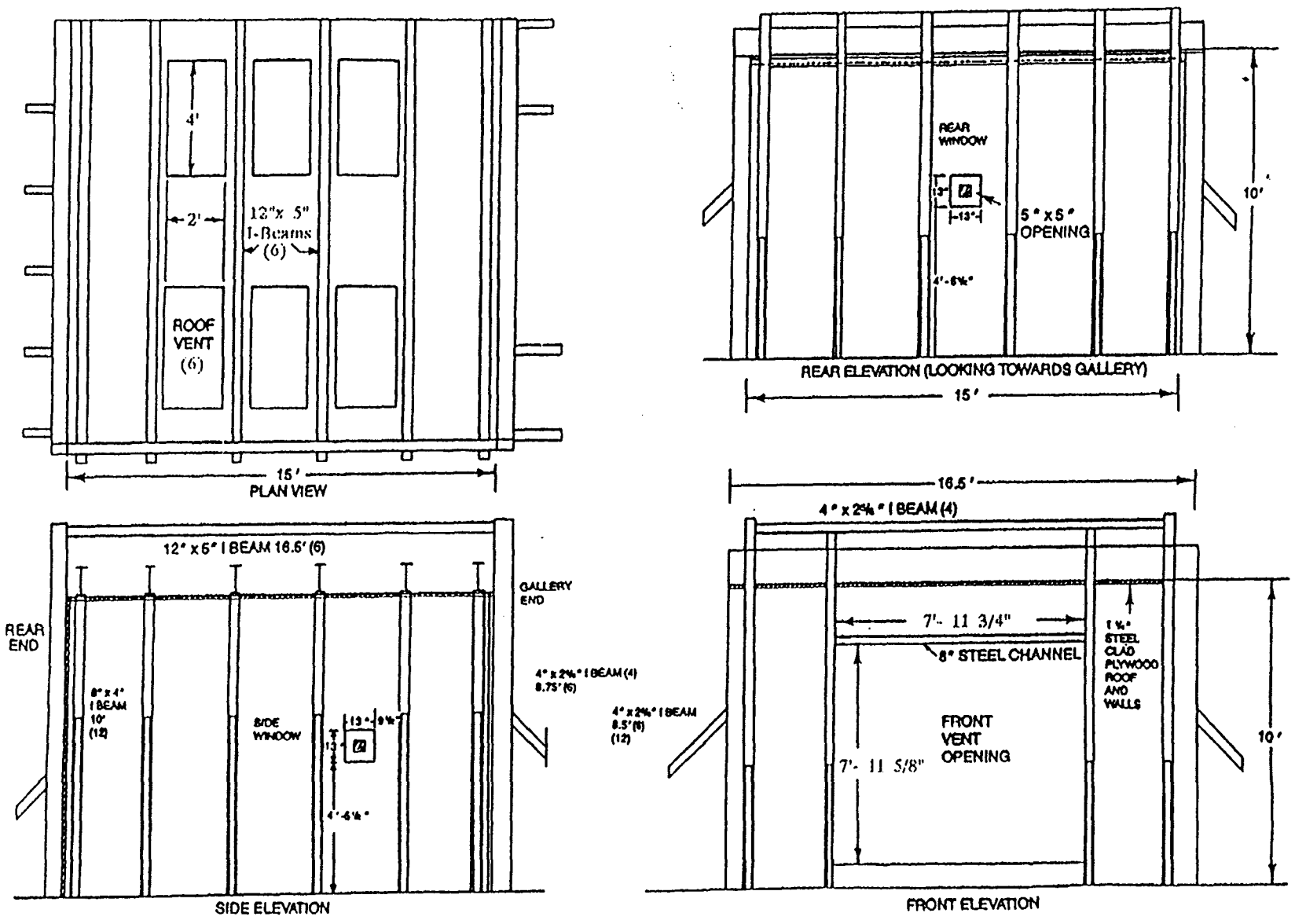

Figure 1. FMRC 63.7 m³ (2250 ft³) Test Chamber.

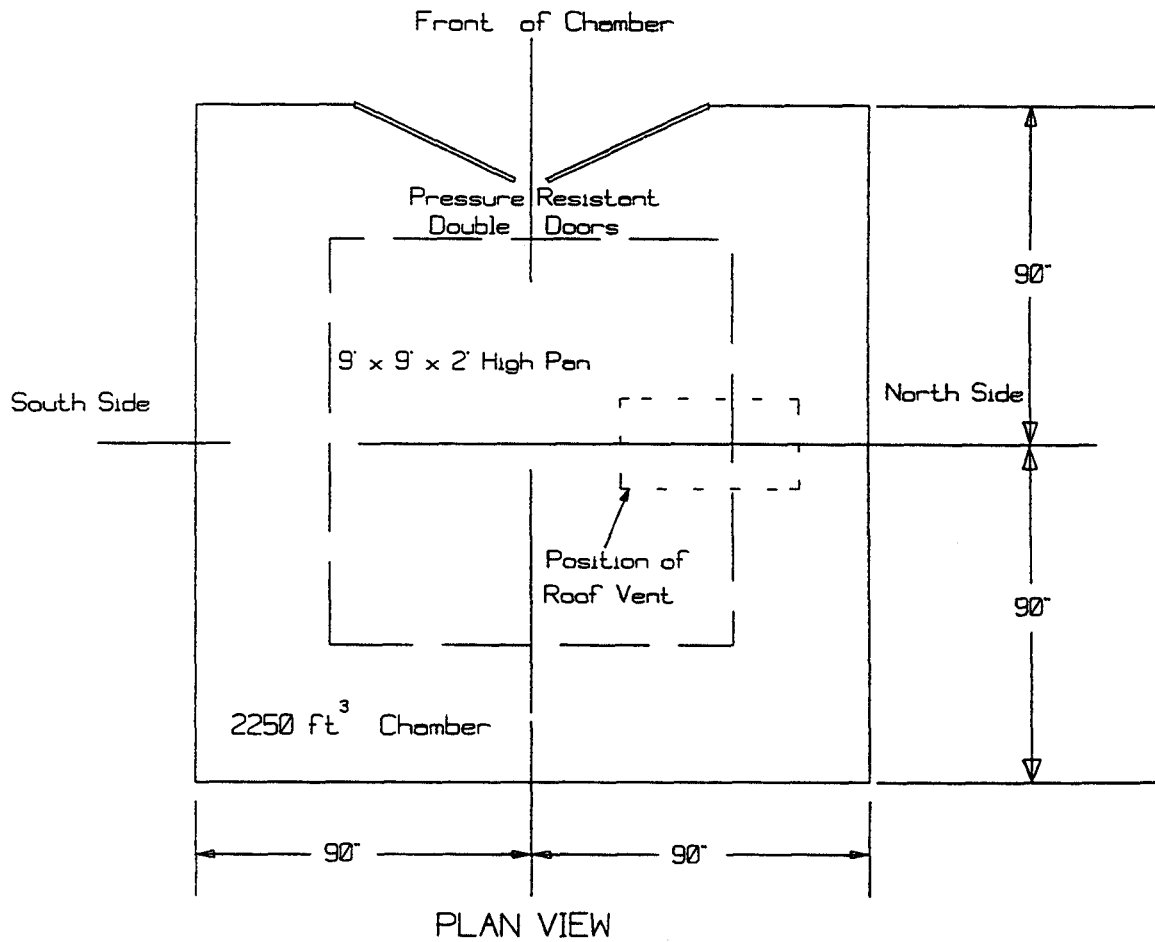

Figure 2. FMRC 63.7 m³ (2250 ft³) Test Chamber (Plan View).

2 ft size) ductwork and, a 0.61 by 0.61 m (2 by 2 ft) diffuser inside the chamber for the tests required to simulate the condition where refrigerant is leaked from the indoor coil into the air handler and can subsequently flow into the residential duct system. The location of the air handler will subsequently be shown in [Figure 6](#).

Three 15 kV arc devices and three gas pilot flames were available as ignition sources to be placed at various locations as required in the tests.

2.2 Refrigerant Injection Systems

2.1.1 Slow Release

The injection of refrigerant for the slow leak scenario involved a vapor release into the test chamber. The refrigerant injection system diagram is shown in [Figure 3](#). The supply cylinder containing the refrigerant or blend was located on a load cell scale (capacity: 181 kg (400 lbs.)) for monitoring both the total amount of refrigerant delivered as well as the release rate. The supply cylinder was connected to a solenoid valve to allow for remote activation and deactivation of flow. Just upstream of the tee leading to the refrigerant entry lines to the heat exchangers, an orifice 0.25 mm (0.01 in.) O.D. was installed for low flow rate. The cold vapors then entered into two parallel connected heat exchangers consisting of 18.9 liter (5-gallon) containers filled with water at elevated temperature up to 70° C (158° F). The containers (reservoirs) were connected to a 22.7 liter (6-gallon) electric water heater with a circulating pump to control the water temperature as necessary. Immersed in these reservoirs were 7.62 m (25 ft) long 6.35 mm (1/4 in.) diameter copper tubing coils carrying the refrigerant. Heat transfer was required to heat the refrigerant from its cold expanded state to ambient temperature vapor. The vapors then entered the delivery line (9.5 mm (3/8 in.) O.D. copper tubing) into the test chamber. An air-actuated ball valve was located immediately outside the wall of the chamber to assure that the flow of refrigerant had ceased in the event of solenoid valve failure by the refrigerant supply cylinder. The refrigerant vapors were released through a 9.5 mm (3/8 in.) O.D. tubing (at the release point).

2.2.2 Fast Release

The injection of refrigerant for fast or catastrophic release scenario was by a jet release resulting in a two-phase mixture. The system was set to have air-actuated ball valves located at both the refrigerant supply cylinder and at the chamber wall. This arrangement assured termination of flow when the appropriate quantity had been released. Approximately 1.83 m

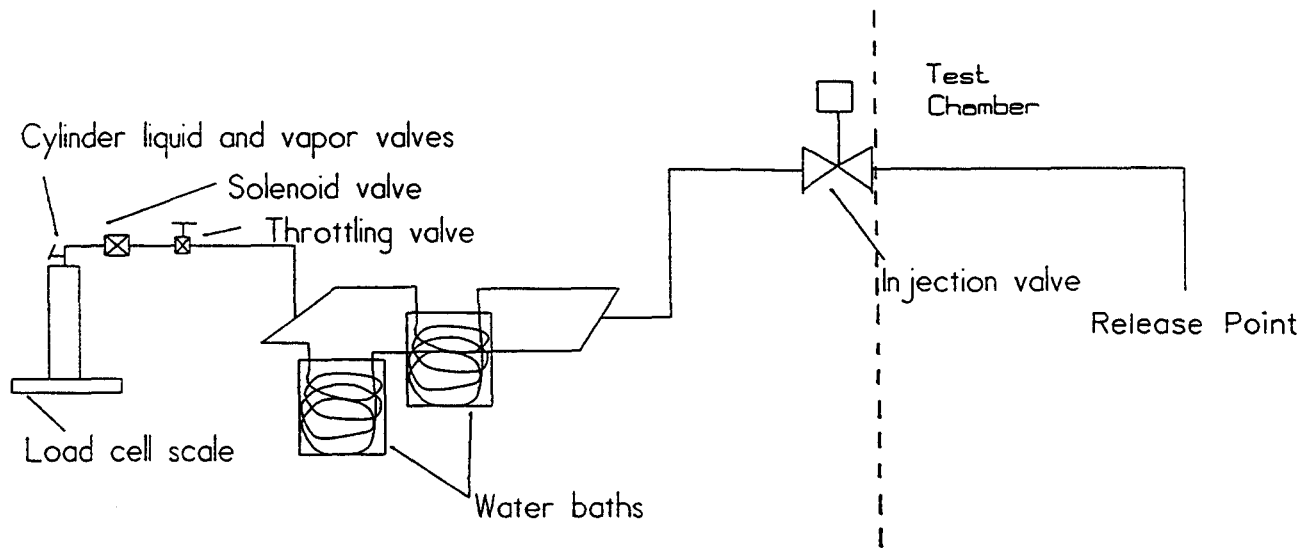

Figure 3. Refrigerant Injection System

(6 ft) of 6.35 mm (1/4 in.) pipe equivalent flex line directly connected the refrigerant supply cylinder to the chamber ball valve. Inside the chamber, 9.5 mm (3/8 in.) O.D. tubing brings the injected charge to the release point. A 1.8 mm (0.07 in.) diameter orifice is attached to the open end of this tubing to control the rate of fast release.

2.3 Concentration Mapping Measurement System

Concentration profiles of flammable gases due to the release of refrigerant inside the chamber were measured at 12 locations. This was done using a multiplexer connected to a gas analysis instrument utilizing a flame ionization detector. Gas concentration data (% vol) were obtained with an instrument (Model EA-700, Eagle Systems, Total Hydrocarbon Analyzer) which is typically used at FMRC for measurements of total hydrocarbons. The sensing element in the analyzer is a flame ionization detector (FID) which provides a continuous response to changes in the composition of the sample stream. This device also responds to the presence of halogenated hydrocarbons. The instrument was calibrated using known concentrations of R-32 and 60%/40% by weight blend of R-32/R-134a in N₂, as shown in [Figure 4](#).

The time response of the analyzer to a step change in concentration was measured as being in the order of approximately 5 seconds, which provides more than adequate time resolution in most applications. This feature of the instrument was exploited by using a single device to obtain concentration data at several locations through multiplexing of the sample stream. Gas was drawn and brought to the analyzer from twelve sampling lines (6.35 mm (1/4 in.) O.D.) which were sequentially connected to the measuring device by a rotary valve. Experience in the use of these multiplexing gas sampling techniques has shown that switching rates of one line every five seconds can easily be achieved. This makes the completion of a 12-channel cycle in one minute. However, due to the length of sampling lines actually used, the total response time of the system was reduced to approximately 15 seconds. Thus, the completion of a 12-channel cycle took 3 minutes.

CALIBRATION CURVE FOR EAGLE SYSTEMS MODEL EA-700 THC ANALYZER
RESPONSE CURVE FOR R32 REFRIGERANT

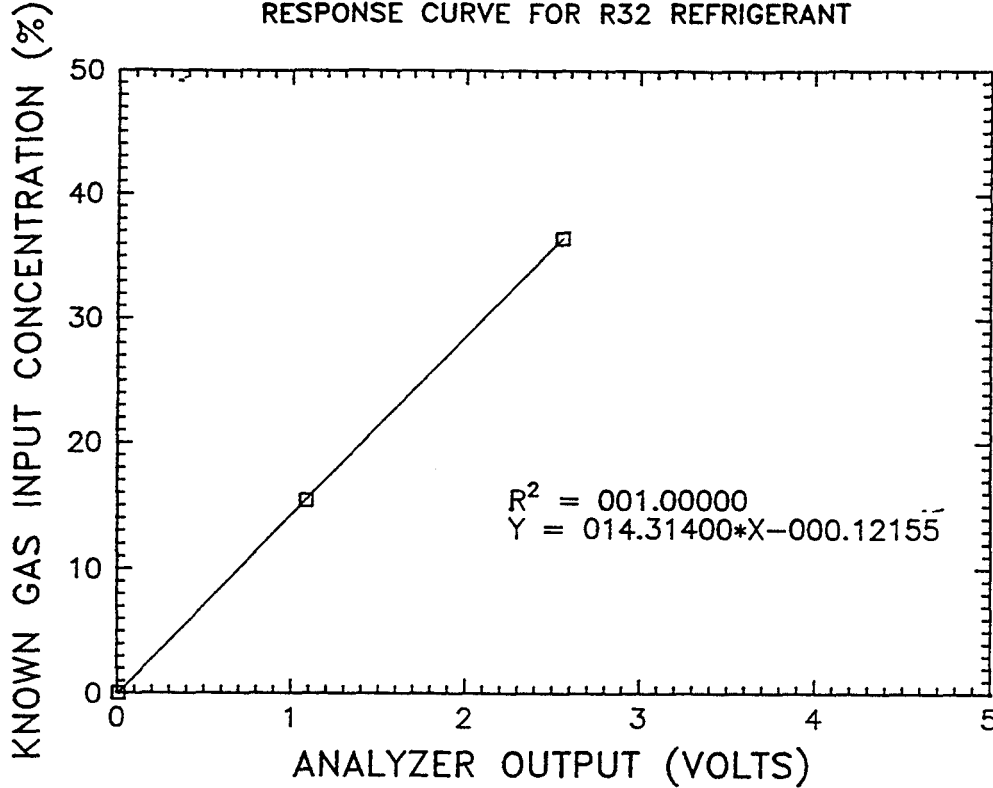

CALIBRATION CURVE FOR EAGLE SYSTEMS MODEL EA-700 THC ANALYZER
RESPONSE CURVE FOR 60/40 % BLEND OF R32/R134A REFRIGERANT

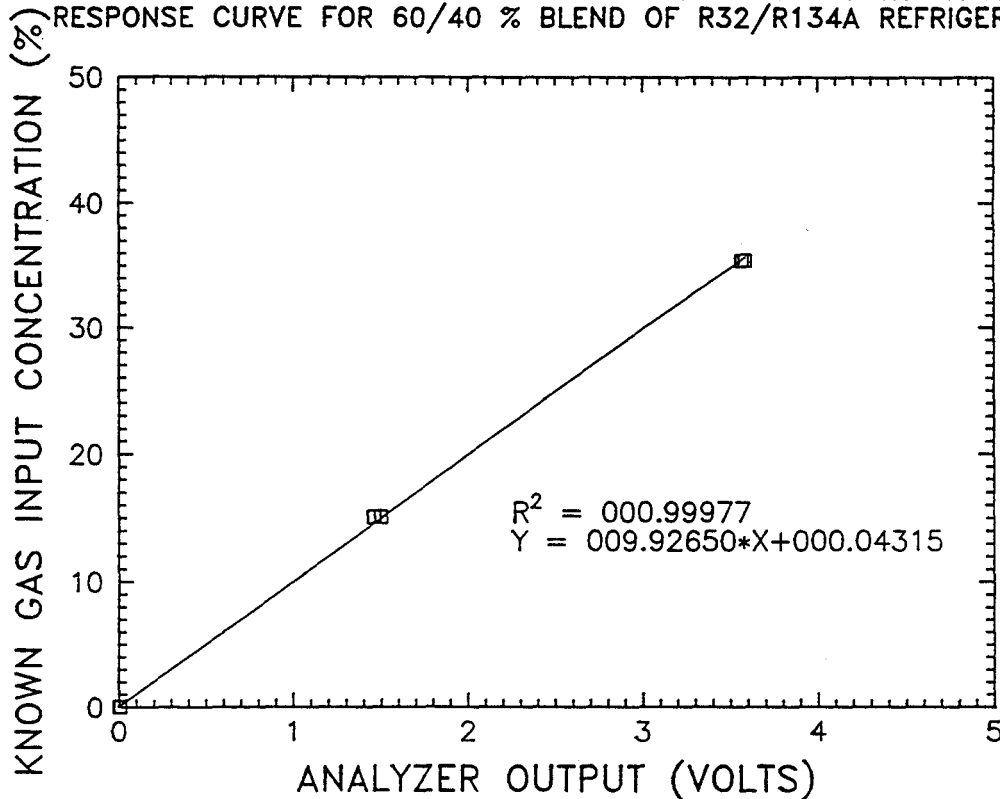

Figure 4. Calibration Curves for Total Hydrocarbon Analyzer. Model EA-700, Eagle Systems.

III

TESTS AND RESULTS

The concentration mapping and ignition tests were conducted using R-32 (vapor density- 1.80 kg/m³) or 60%/40% by weight of R-32/R-134a (vapor density of R-134a- 3.20 kg/m³), leaking at fast as well as slow rates. The fast leaking rate was a two-phase release at approximately 2000-3000 g/min (4.4– 6.6 lbs./min) until a full charge of approximately 5.5 kg (12.1 lbs.) of refrigerant was depleted. The slow release was a vapor release of the entire charge of approximately 5.5 kg (12.1 lbs). The amount of refrigerant release in the tests corresponded to the approximate charge of R-32 required for a high efficiency 5-ton (11,000-lb) heat pump. The fast or catastrophic leak rate simulated a complete line break. The slow leak attempted to simulate a leak caused by a tube failure from vibration or rubbing.

Most of the concentration-mapping tests were performed with R-32, with a few blend tests to allow for differences in behavior to be observed. The concentrations of refrigerant were measured at 12 locations based on the configurations of the test. The ignition tests were conducted only with R-32.

All tests were performed at chamber temperatures of 27-32°C (80-90° F) with a relative humidity of 60-70%.

3.1 Concentration Mapping Tests

3.1.1 Test Configurations

The test chamber was configured to represent several leak scenarios, such as a leak into a room, to the outdoors, in the indoor air handler coil (which spreads to the duct if the air flow is on), and into a utility closet. The detailed configurations are described below.

3.1.1.1 Leak into a Room - The aluminum pan inside the chamber (as shown in [Figure 5](#)) was used to simulate a room. The refrigerant was discharged from the supply tube to a point approximately 0.305 m (1 ft) from the corner of the pan and 0.305 m (1 ft) from the floor of the pan. This location is identified as ‘release point’ in [Figure 5](#). The release point was directed towards the floor of the pan. This arrangement simulated a break in the pipe running to the air handler. All room leak tests were conducted in a quiescent environment.

The gas sampling line layout for room leak tests is also shown in [Figure 5](#). The refrigerant release point was located on the diagonal line of the pan. The first set of three sampling points was located 0.305 m (12 in.) away from the release point and 0.152 m (6 in.) above the pan, and at 0, 30 and 60 degrees from the diagonal line relative to the release point.

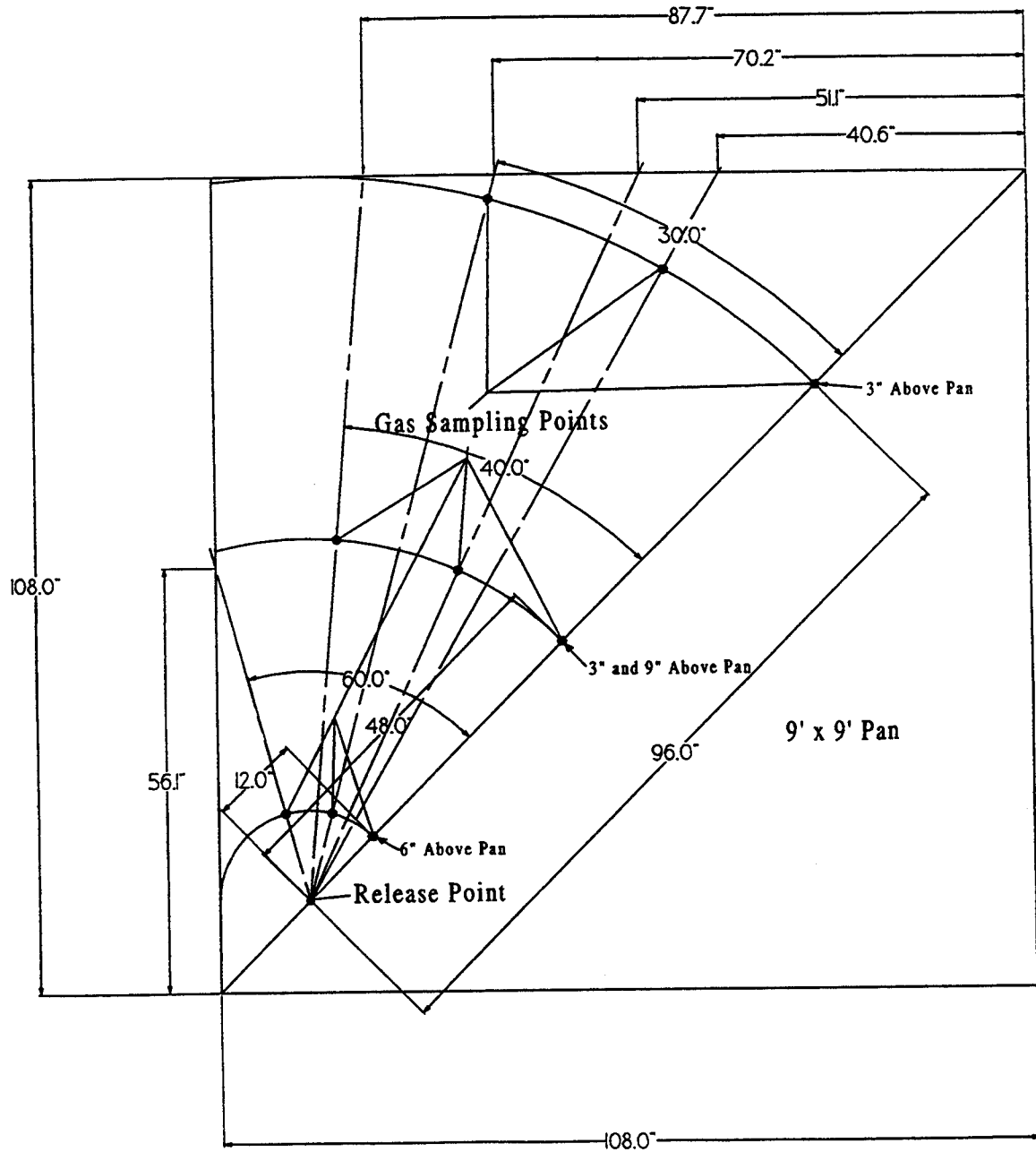

Figure 5. Gas Sampling Layout for Room Leak Test
 (All measurements are inches except for the pan)

The second set of six sampling points was located 1.22 m (48 in.) away from the release point at 0.076 m (3 in.) and 0.23 m (9 in.) above the pan. They were placed on the diagonal line, and at 20 and 40 degrees relative to the release point. Finally, the third set of three sampling points were located 2.44 m (96 in.) away from the release point and 0.076 m (3 in.) above the pan on the diagonal line, and at 15 and 30 degrees relative to the release point. Heights and locations of the gas sampling points were adjusted from test to test.

3.1.1.2 Outdoor Leak - A 0.017 m³/s (36 CFM) fan (0.076 m (3 in.) diameter) was placed at the corner of the pan, behind the release point at the same elevation. The fan was aimed at the release point. The air flow from the fan simulated an outdoor leak environment. All other conditions were the same as above.

3.1.1.3 Leak in the A-coil of the Air Handler Unit - As mentioned earlier, a Carrier Model FC4A-070 air handler was installed at a height of 0.23 m (9 in.) above the floor approximately 0.305 m (1 ft) from the east wall of the chamber (Fig. 6), simulating a basement or attic installation. The refrigerant release point was placed close to the A-coil of the air handler.

Twelve gas sampling points (lines) are shown in Figure 6 for the tests with the air handler blower off. Six gas sampling points were located inside the air handler. These were located 0.089 m (3.5 in.) below the refrigerant release point (#1), on the left and right sides of the blower (#2 and #3), 0.146 m (5.75 in.) away (#4) from the wall of the electrical box and in the middle of the electrical box (#5) and near the heater coil (#6). The other six gas sampling points were located around the periphery of the air handler on the floor. On the south side of the chamber, two gas sampling points were located 0.152 m (6 in.) and 0.305 m (12 in.) from the air handler, 0.076 m (3 in.) above the floor (#7 and #10). On the east side of the chamber, two other gas sampling points were located at the edge of the air handler and 0.305 m (12 in.) away from the air handler at 0.076 m (3 in.) above the floor (#8 and #11). Finally, two gas sampling points were placed on the north side of the chamber 0.152 m (6 in.) and 0.305 m (12 in.) away from the air handler, 0.076 m (3 in.) above the floor (#9 and #12).

The sampling point layout for the tests with the air handler blower on (0.42 m³/s, 900 CFM) are shown in Figure 7. Five gas sampling lines were placed in the air handler unit. These were located 0.089 m (3.5 in.) below the refrigerant release point (#1), 0.254 m (10 in.) from the bottom and 0.38 m (15 in.) inside (A-coil volume)(#2), on the right side of the blower (#3),

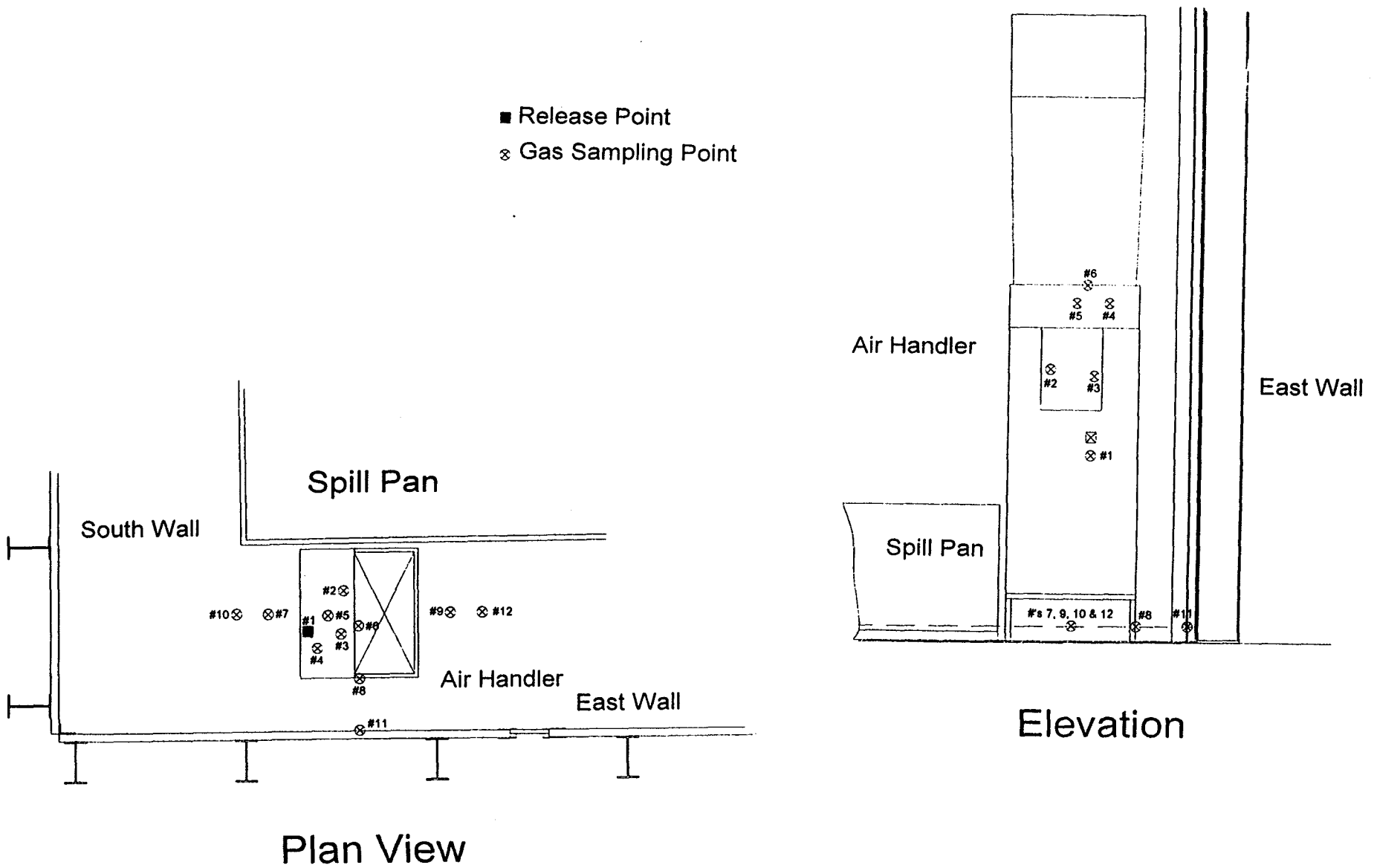

Figure 6. Release Location and Gas Sampling Locations for Fast and Slow Refrigerant Releases in Air handler (Blower Off).

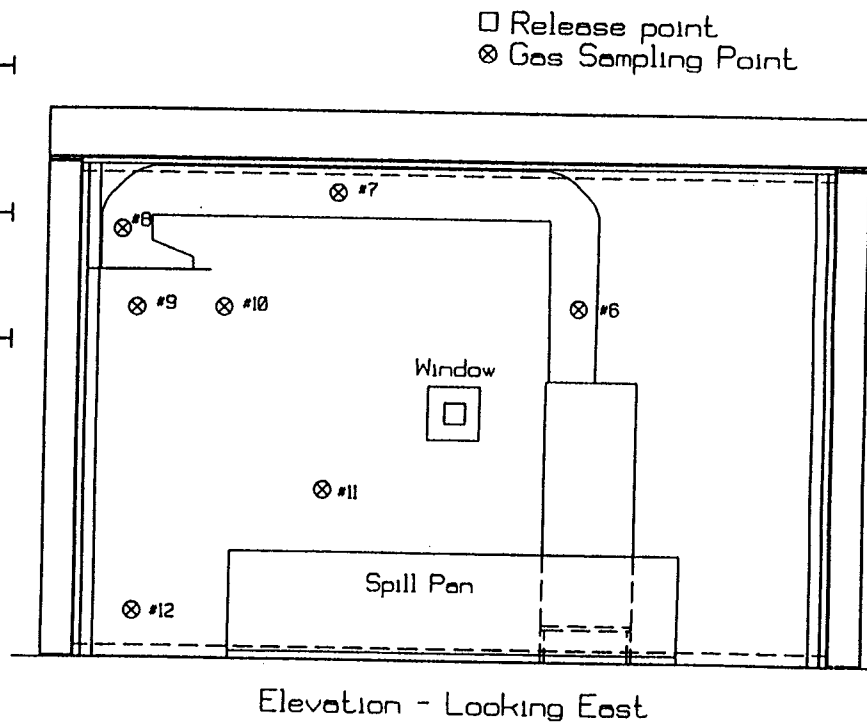
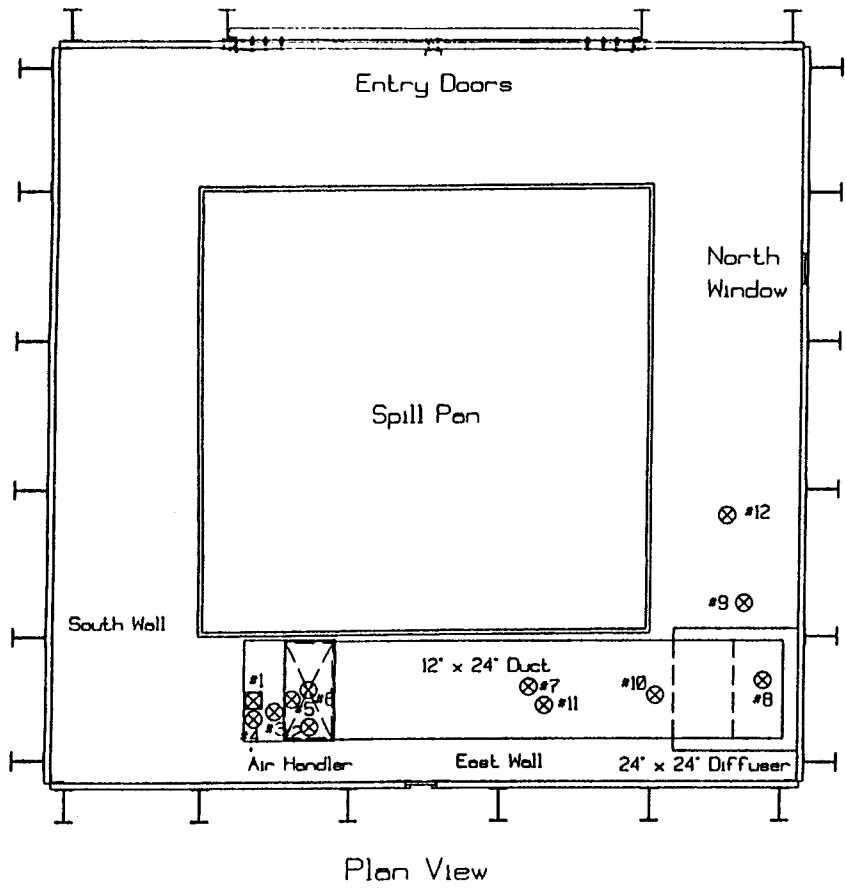

Figure 7. Release Location and Gas Sampling Locations for Fast-Release in Air Handler (Blower On: at 900 CFM).

0.146 m (5.75 in.) from the wall of the electrical box (#4), and near the heater coil (#5). Three gas sampling lines were placed inside the supply duct. One halfway up the vertical leg (#6), one halfway along the horizontal run (#7) and the third halfway down the vertical near the diffuser (#8). The remaining four sampling points were placed at the discharge of the duct (diffuser) in the chamber. Two sampling points were 0.152 m (6 in.) from the diffuser outlet and 0.229 m (9 in.) down on the west and south sides (#9 and #10). The remaining two sampling points (#11 and #12) were 0.762 m (30 in.) from the diffuser and 1.07 m (42 in.) and 0.305 m (12 in.) from the floor of the chamber (south side) and (west side), respectively.

3.1.1.4 Leak in the A-coil of the Air Handler Unit inside a Closet - An enclosure representing a utility closet was fabricated from 9.5 mm (3/8 in.) thick plywood and installed around the air handler, as shown in Figure 8. One of the closet walls was the test chamber wall (east side). The dimensions were approximately 0.91 by 1.37 by 2.44 m (3 by 4.5 by 8 ft. high) with a solid door on the north side 3.2 mm (1/8 in.) gap between the door and the chamber floor, which remained closed during the tests.

The refrigerant release point was placed close to the A-coil of the air handler. The distribution of twelve gas sampling points inside and outside the closet is shown in Figure 8. One sampling line was placed 0.09 m (3.5 in.) below the refrigerant release point inside the air handler. Nine gas sampling lines were located in the closet: on the south side, 0.127 m (5 in.) from the air handler and 0.152 m (6 in.), 0.051 m (2 in.) and 1.07 m (42 in.) high; 0.051 m (2 in.) from the east wall and 0.152 m (6 in.), 0.051 m (2 in.) and 1.07 m (42 in.) high; on the north side, 0.305 m (12 in.) from the air handler and 0.152 m (6 in.), 0.051 m (2 in.) and 1.07 m (42 in.) high. The remaining two were placed outside the closet 0.152 m (6 in.) and 0.305 m (12 in.) from the door, 0.051 m (2 in.) and 0.025 m (1 in.) above the floor, respectively. All tests were conducted with the air handler blower off.

3.1.2 Concentration Mapping Test Sequence

The following tests were conducted:

<u>Test Type</u>	<u>Test Conditions</u>	<u>Test No.</u>
Room Leak in Quiescent Environment	Fast Release of R-32	#1 and #4
Room Leak in Quiescent Environment	Slow Release of R-32	#2 and #9
Outdoor Leak (in the room with air flow)	Slow Release of R-32	#3

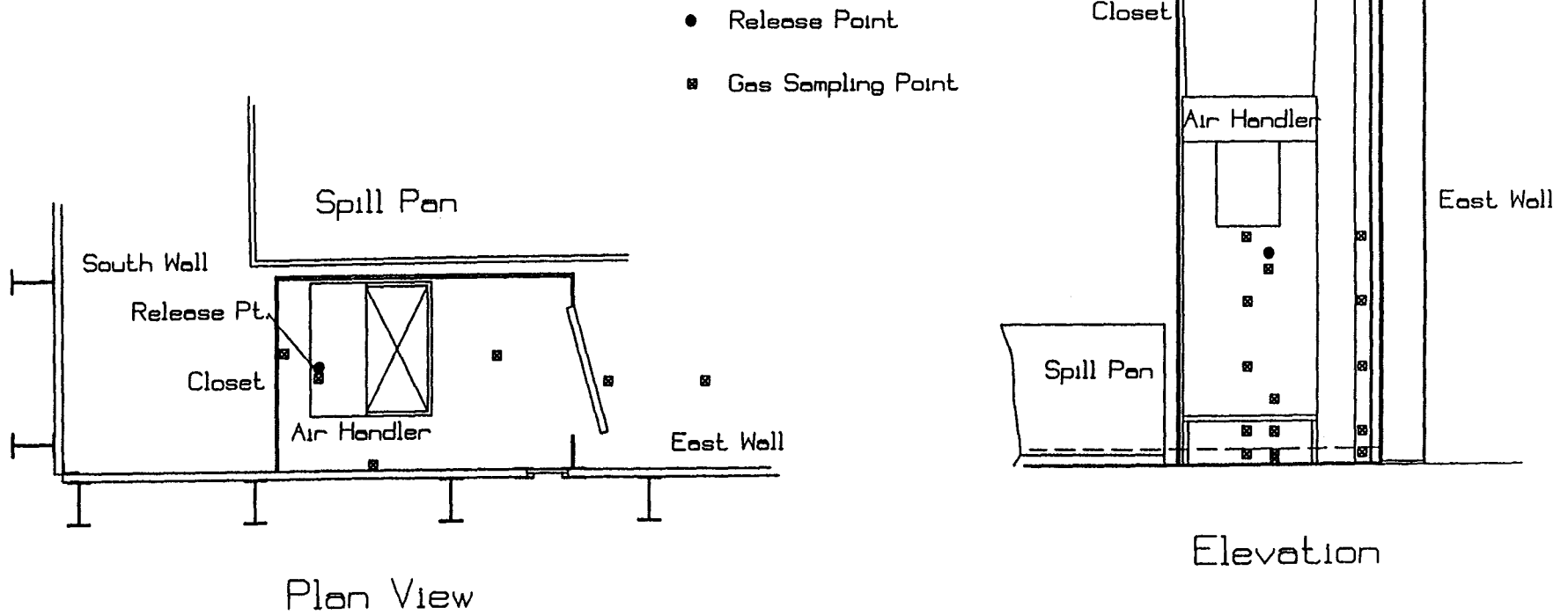

Figure 8. Release and Gas Sampling Locations for Refrigerant Release in Air Handler Inside the Closet.

Leak in Air Handler Unit with blower off	Slow Release of R-32	#6
Leak in Air Handler Unit with blower off	Fast Release of R-32	#5
Leak in Air Handler Unit with blower on	Fast Release of R-32	#7
Repeat of Test #7	Fast Release of R-32	#8
Leak in Air Handler Unit inside a closet with blower off	Fast Release of 60%/40% by weight of R-32/R-134a	#10
Repeat of Test #10	Repeat: gas sampling lines moved	#11
Leak in Air Handler Unit inside a closet with blower off	Slow Release of 60%/40% by weight of R-32/R-134a	#12
Leak in Air Handler Unit inside a closet with blower off	Fast Release of R-32	#13
Repeat of Test #13	Repeat	#14

3.1.3 Concentration Mapping Test Results

3.1.3.1 Room Leak (refer to [Figure 5](#))

- a) **Fast Release:** [Figures 9a](#) and [9b](#) present concentrations of R-32 as a function of time at various locations and elevations on the pan (refer to [Fig. 5](#)). [Figure 9a](#) shows that concentration profiles are uniform at elevations of 0.076 m (3 in.) up to 0.228 m (9 in.) as far as 2.44 m (8 ft.) away from the release point. It should be pointed out in [Figure 9b](#) that the concentrations at 0.152 m (6 in.) and 0.228 m (9 in.) elevations at distances of 0.305 m (12 in.) and 1.22 m (48 in.), respectively, from the release point are lower than the concentrations in the same locations in the previous test ([Fig. 9a](#)). This could be due to an instrumentation problem. The results in Test #3 appeared to be more reliable, based on the amount of refrigerant released. However, based on the sampling of gas concentrations at the locations and elevations on the pan, the data in [Figures 9a](#) and [9b](#) indicate that the concentrations of R-32 were significantly lower than the lower flammable limit (LFL), which is about 13% by vol.

Test #1 - 5.45 Kg R-32, Fast Release in a Quiescent Environment (Room)
Release Rate = 2411 g/min Through a 0.070" Orifice

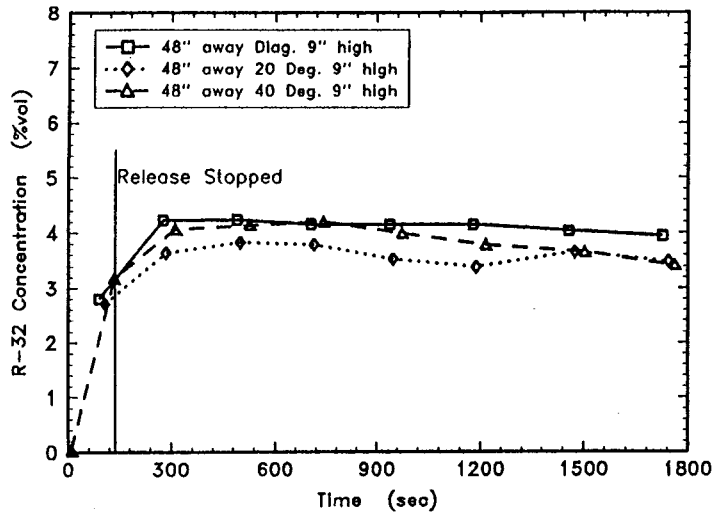

Test #1 - 5.45 Kg R-32, Fast Release in Quiescent Environment (Room)
Release Rate = 2411 g/min Through a 0.070" Orifice

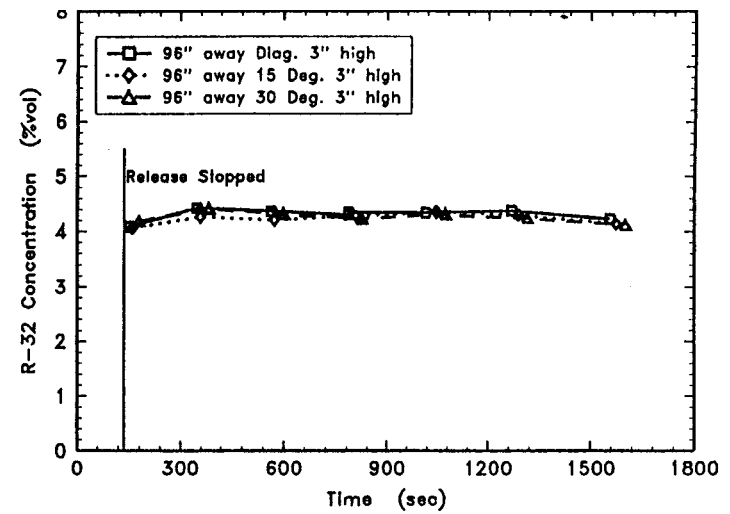

Test #1 - 5.45 Kg R-32, Fast Release in a Quiescent Environment (Room)
Release Rate = 2411 g/min Through a 0.070" Orifice

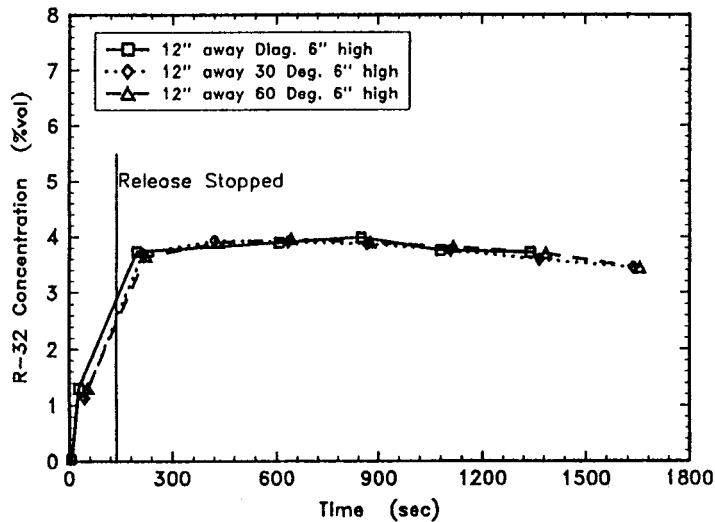

Test #1 - 5.45 Kg R-32, Fast Release in a Quiescent Environment (Room)
Release Rate = 2411 g/min Through a 0.070" Orifice

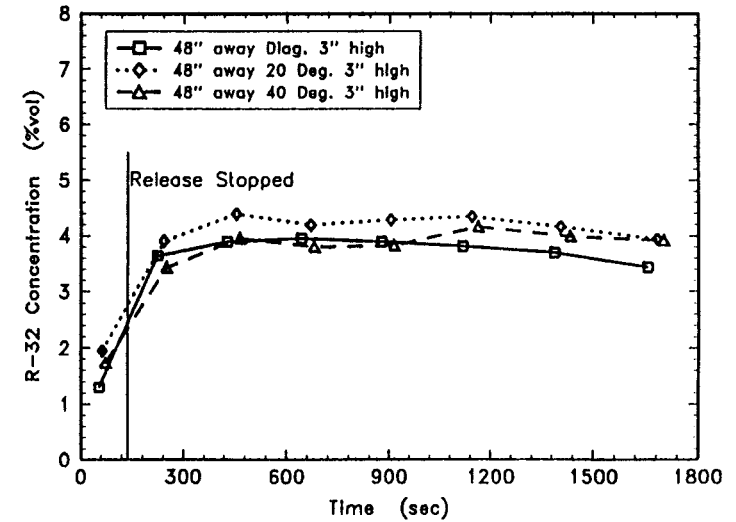
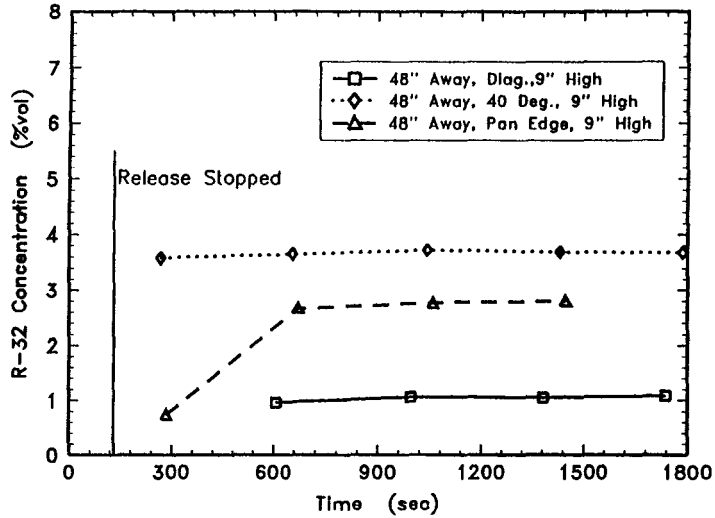
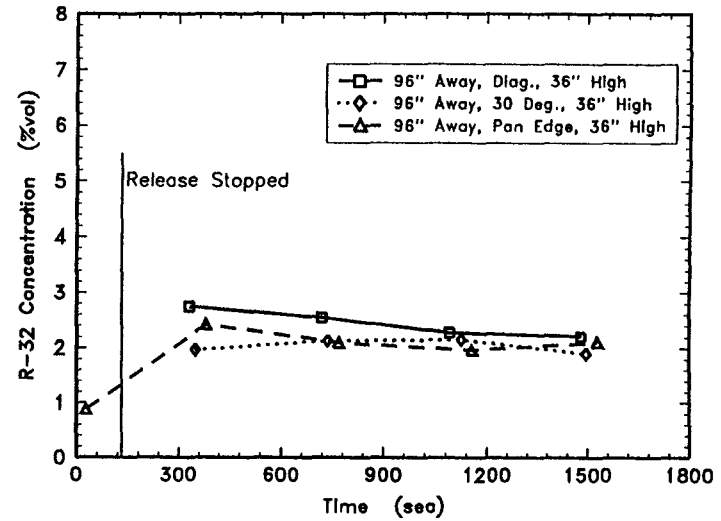

Figure 9a. Concentrations of R-32 (Fast Release) as a Function of Time at Various Locations and Elevations on the Pan.

Test #4 - 5.31 Kg R-32, Fast Release in a Quiescent Environment (Room)
Release rate = 2453 g/min Through a 0.070" Orifice



Test #4 - 5.31 Kg R-32, Fast Release in a Quiescent Environment (Room)
Release rate = 2453 g/min Through a 0.070" Orifice



Test #4 - 5.31 Kg R-32, Fast Release in a Quiescent Environment (Room)
Release rate = 2453 g/min Through a 0.070" Orifice

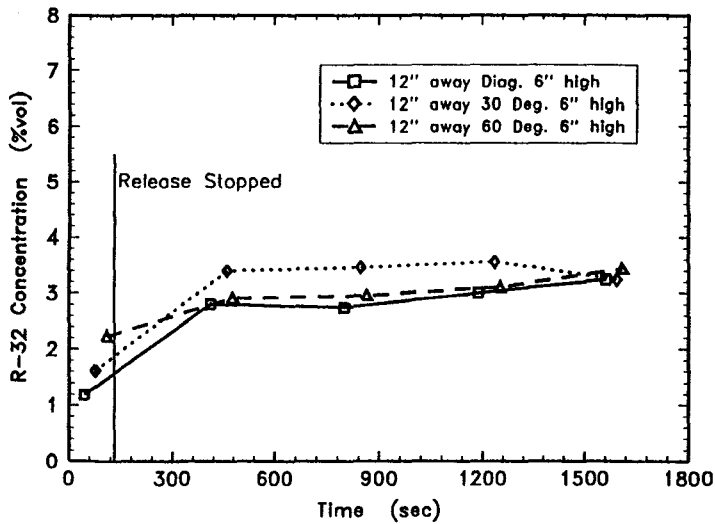

Test #4 - 5.31 Kg R-32, Fast Release in a Quiescent Environment (Room)
Release rate = 2453 g/min Through a 0.070" Orifice

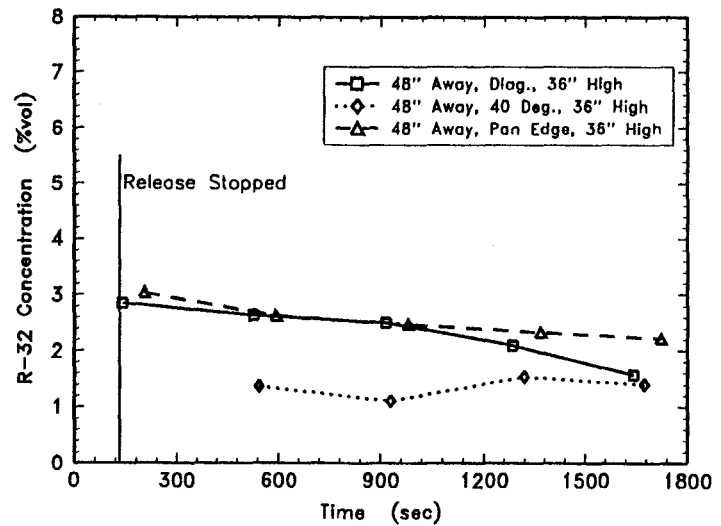

Figure 9b. Concentrations of R-32 (Fast Release) as a Function of Time at Various Locations and Elevations on the Pan.

- b) **Slow Release:** In the slow release case, the R-32 refrigerant produced flammable concentrations at various locations (at 0.305 m (1 ft), 1.22 m (4 ft) and 2.44 m (8 ft) away from the release point) and elevations (0.076 to 0.305 m (3 to 12 in.) from the floor of the pan), as shown in [Figure 10a](#). As can be noted in [Fig. 10a](#), the concentration steadily increased during the release of R-32 up to completion for a total amount of ~5.5 kg (12.1 lbs). The concentration remained steady for a while and then started decreasing after the termination of refrigerant release. In order to confirm that the concentrations will eventually decrease below the LFL due to the leakage from the test enclosure, a second test was conducted for an extended period of time after the completion of refrigerant release, as indicated in [Figure 10b](#). It is interesting to observe that flammable concentrations were noted at 0.076 m to 0.305 m (3 to 12 in.) elevations from the pan at distances of 0.305, 1.22 and 2.44 m (1, 4, and 8 ft) away from the release point, but at the higher elevation of 0.61 m and 0.91 m (2 and 3 ft) at a 1.22 m (4 ft.) distance, concentrations never reached the LFL.

3.1.3.2 Outdoor Leak (refer to [Figure 5](#))

Slow Release: As mentioned earlier, the outdoor leak was simulated by releasing refrigerant at a slow rate with air blowing from a fan behind the refrigerant release point. As expected, the dilution of the leak by the flow of air kept the concentrations well below the LFL, as shown in [Figure 11](#), at various elevations of 0.152, 0.23 and 0.91 m (6 in., 9 in. and 3 ft) and distances of 0.305, 1.22 and 2.44 m (1, 4 and 8 ft) from the refrigerant release point.

3.1.3.3 Leak in Air Handler Unit (refer to [Figures 6 and 7](#))

- a) **Slow Release With Air Handler Blower off:** The concentration data for slow release of R-32 into the air handler unit are presented in [Figure 12a](#). Nowhere, inside as well as outside the air handler at 12 gas sampling locations, the refrigerant concentrations reached the lower flammable limit.
- b) **Fast Release With Air Handler Blower off:** The fast release of R-32 into the air handler produced no or marginally flammable concentrations inside the air handler gas sampling locations, as shown in [Figure 12b](#). However, at the location close to the release point, the concentration momentarily reached the lower flammable limit, but immediately dropped to negligibly small concentrations. The concentration profiles outside the air handler at the floor locations 0.076 m (3 in.) above are also shown in [Figure 12b](#). The flammable concentrations at those locations were lower than the LFL, except for the location 0.305 (12 in.) from the air

Test #2 - 5.52Kg R-32, Slow Release in a Quiescent Environment (Room)
 Vapor Release Rate = 85 g/min Through Heat Exchanger System

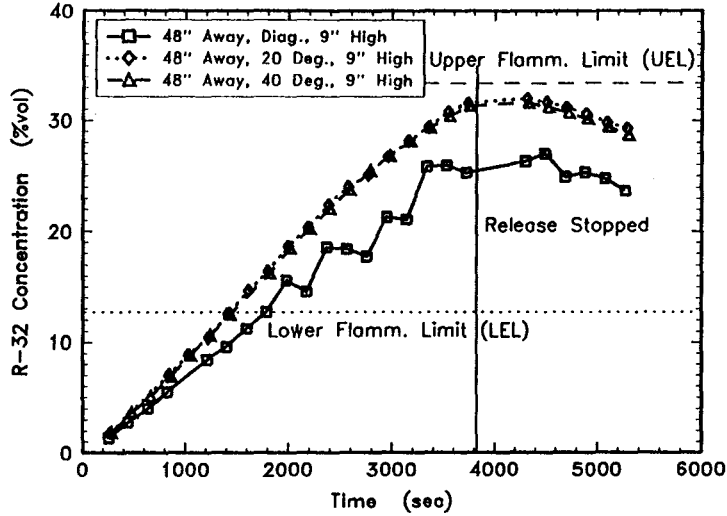

Test #2 - 5.52Kg R-32, Slow Release in a Quiescent Environment (Room)
 Vapor Release Rate = 85 g/min Through Heat Exchanger System

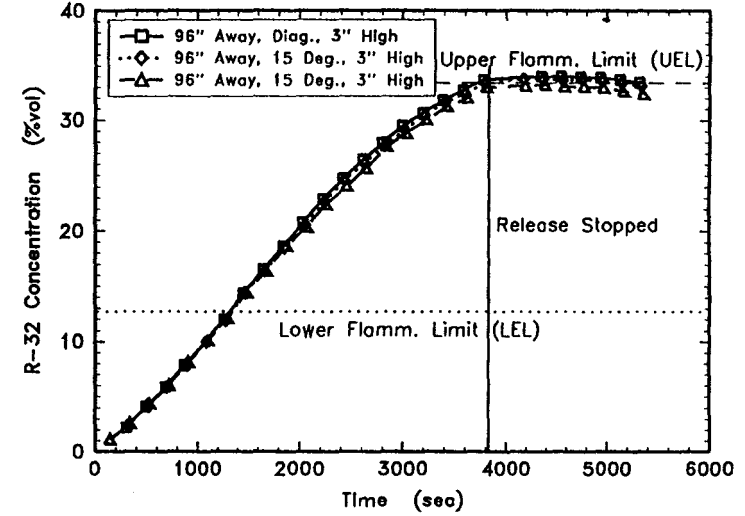

Test #2 - 5.52Kg R-32, Slow Release in a Quiescent Environment (Room)
 Vapor Release Rate = 85 g/min Through Heat Exchanger System

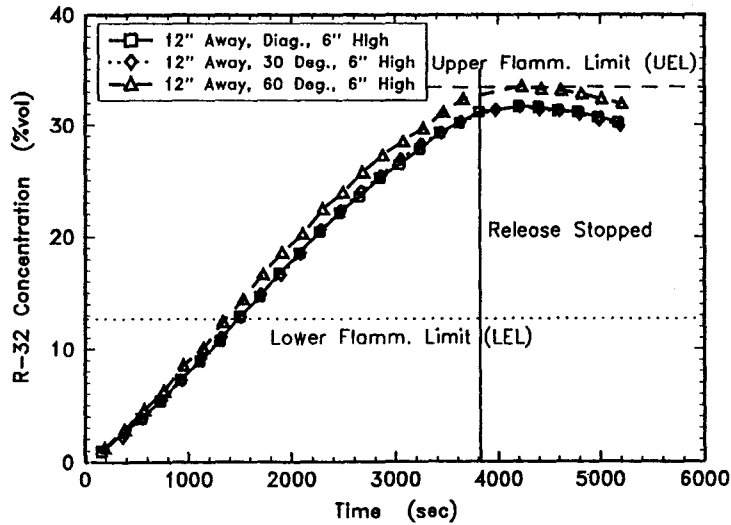

Test #2 - 5.52Kg R-32, Slow Release in a Quiescent Environment (Room)
 Vapor Release Rate = 85 g/min Through Heat Exchanger System

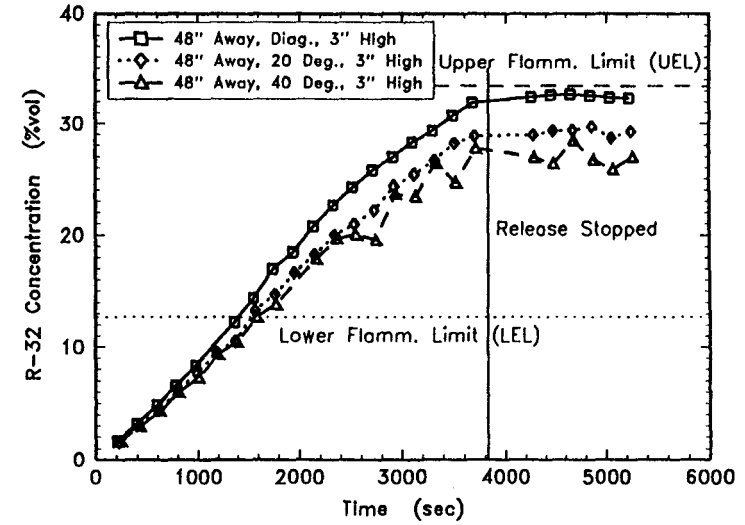
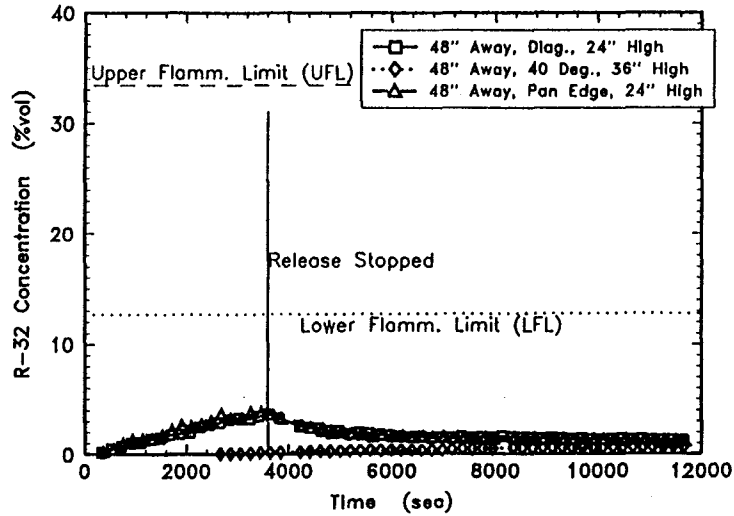
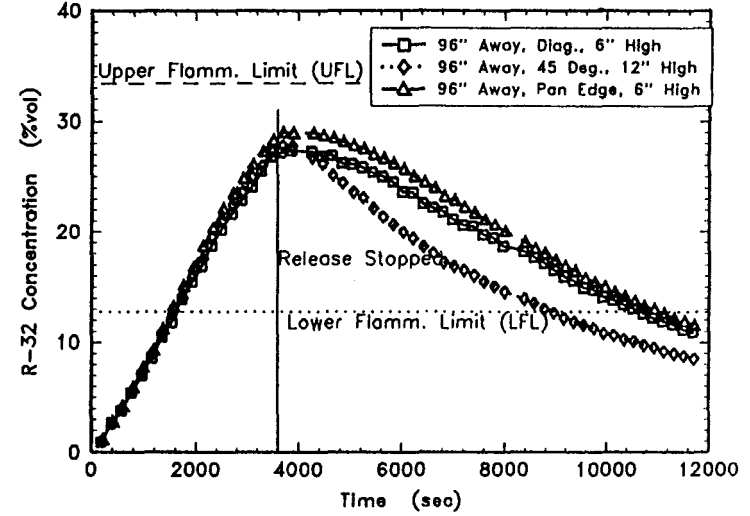

Figure 10a. Concentrations of R-32 (Slow Release) as a Function of Time at Various Locations and Elevations on the Pan.

Test #9 - 5.583 Kg R-32, Slow Release In a Quiescent Environment (Room)
 Vapor Release Rate = 95 g/min Through Heat Exchanger System



Test #9 - 5.583 Kg R-32, Slow Release In a Quiescent Environment (Room)
 Vapor Release Rate = 95 g/min Through Heat Exchanger System



Test #9 - 5.583 Kg R-32, Slow Release In a Quiescent Environment (Room)
 Vapor Release Rate = 95 g/min Through Heat Exchanger System

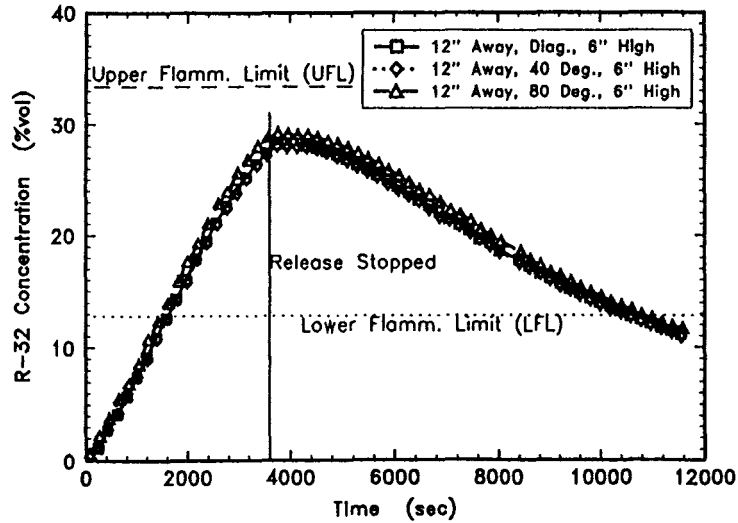

Test #9 - 5.583 Kg R-32, Slow Release In a Quiescent Environment (Room)
 Vapor Release Rate = 95 g/min Through Heat Exchanger System

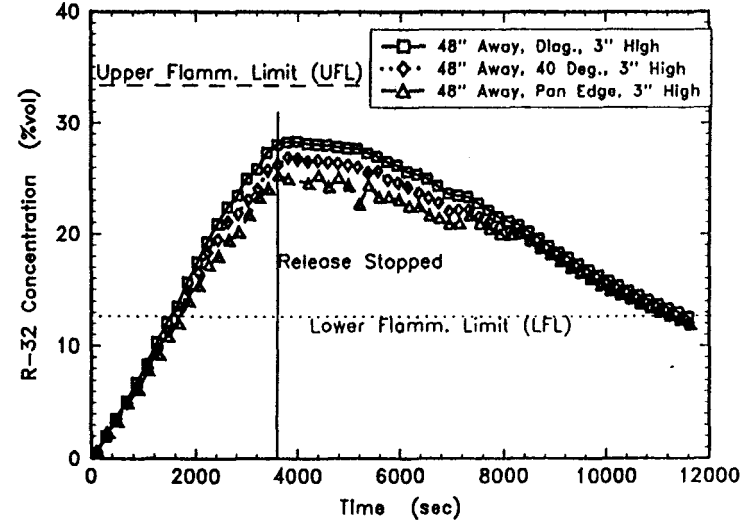
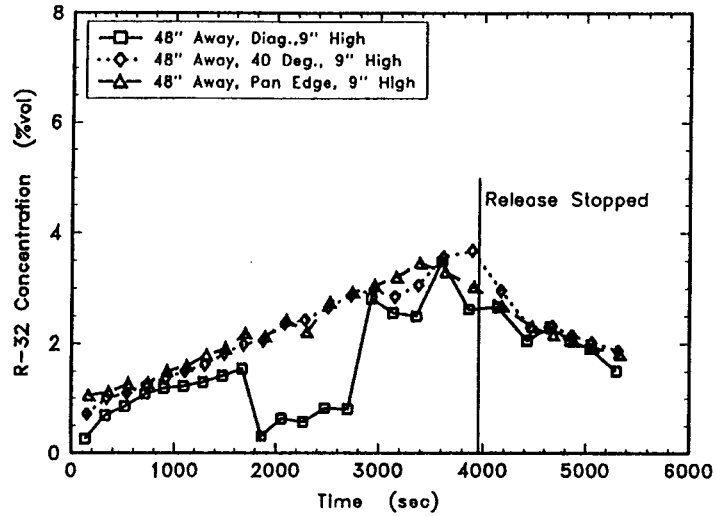
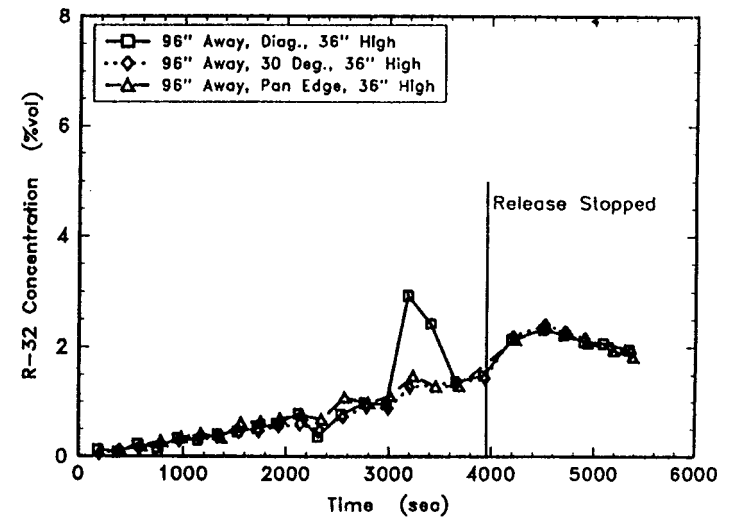

Figure 10b. Concentrations of R-32 (Slow Release) as a Function of Time at Various Locations and Elevations on the Pan (test conducted for extended period of time).

Test #3 - 5.5 Kg R-32 Slow Release In a Room with 36 CFM Fan
 Vapor Release Rate = 83 g/min Through Heat Exchanger System



Test #3 - 5.5 Kg R-32 Slow Release In a Room with 36 CFM Fan
 Vapor Release Rate = 83 g/min Through Heat Exchanger System



Test #3 - 5.5 Kg R-32 Slow Release In a Room with 36 CFM Fan
 Vapor Release Rate = 83 g/min Through Heat Exchanger System

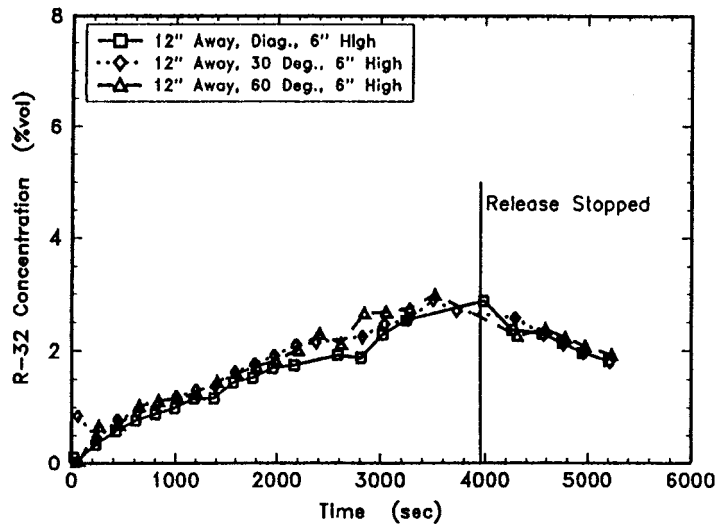

Test #3 - 5.5 Kg R-32 Slow Release In a Room with 36 CFM Fan
 Vapor Release Rate = 83 g/min Through Heat Exchanger System

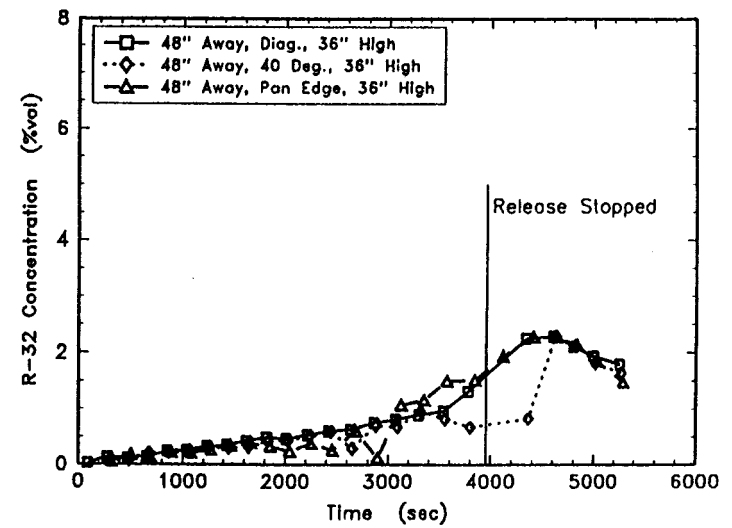
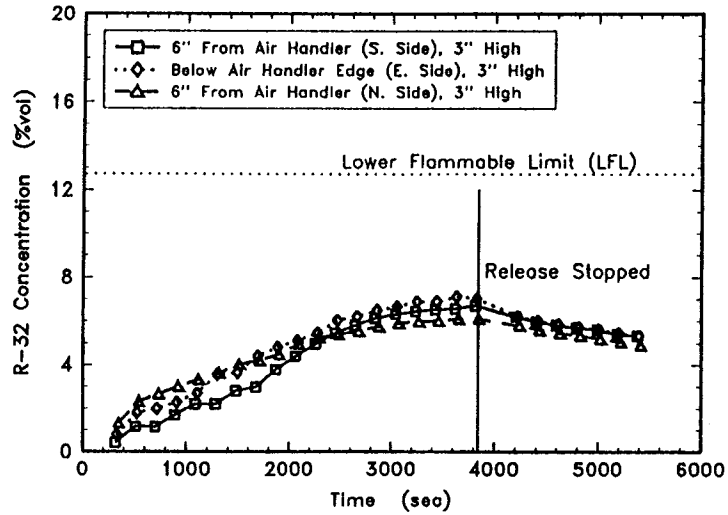
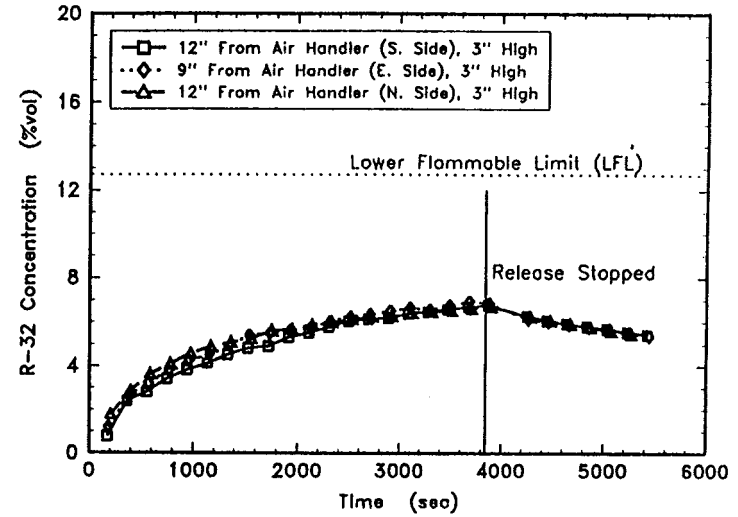

Figure 11. Concentrations of R-32 (Slow Release: simulation of outdoor release) as a Function of Time at Various Locations And Elevations on the Pan.

Test #6 - 5.0 Kg R-32, Slow Release In Air Handler (Blower "OFF")
 Release Rate = 79 g/min Through Heat Exch. System, Release Near "A"-Coil



Test #6 - 5.0 Kg R-32, Slow Release In Air Handler (Blower "OFF")
 Release Rate = 79 g/min Through Heat Exch. System, Release Near "A"-Coil



Test #6 - 5.0 Kg R-32, Slow Release In Air Handler (Blower "OFF")
 Release Rate = 79 g/min Through Heat Exch. System, Release Near "A"-Coil

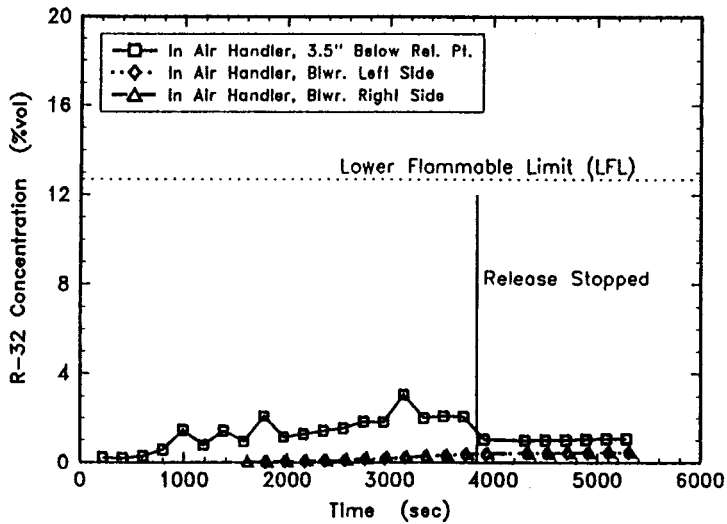

Test #6 - 5.0 Kg R-32, Slow Release In Air Handler (Blower "OFF")
 Release Rate = 79 g/min Through Heat Exch. System, Release Near "A"-Coil

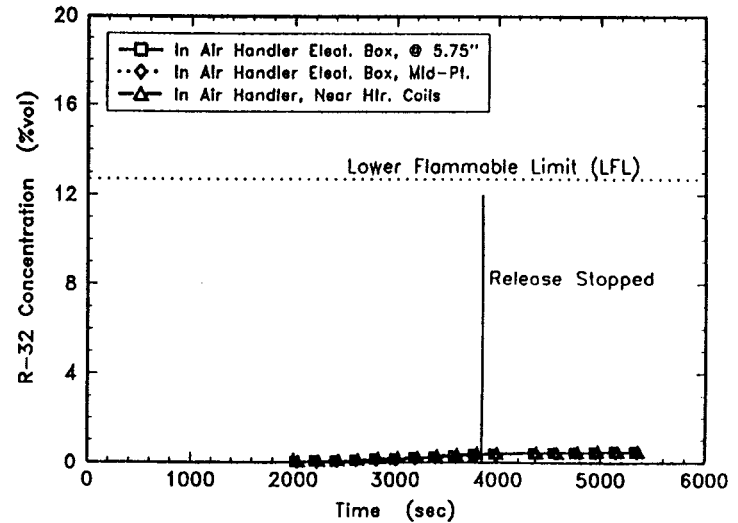
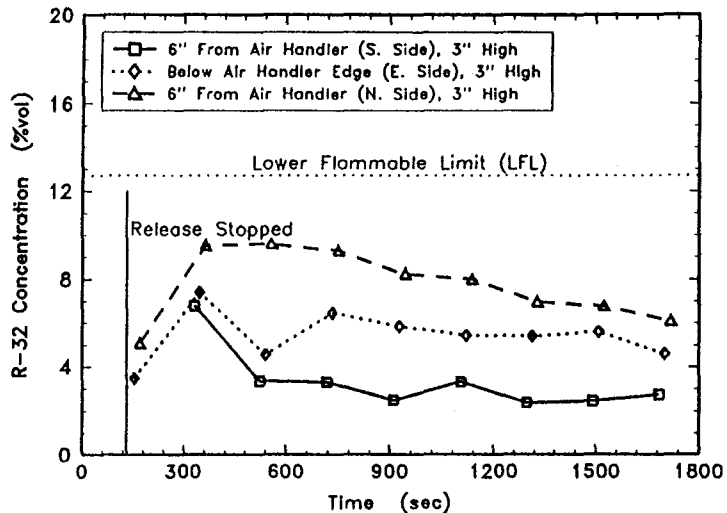
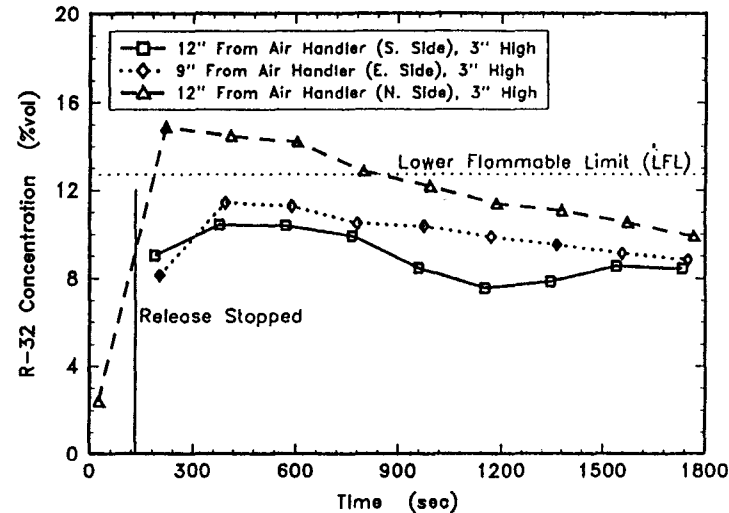

Figure 12a. Concentrations of R-32 (Slow Release into the Air Handler with Blower Off) as a Function of Time at Various Locations Inside and Outside the Air Handler.

Test #5 - 5.39 Kg R-32, Fast Release in Air Handler (Blower "OFF")
Release rate = 2436 g/min Through a 0.070" Orifice, Near "A"-Coil



Test #5 - 5.39 Kg R-32, Fast Release in Air Handler (Blower "OFF")
Release rate = 2436 g/min Through a 0.070" Orifice, Near "A"-Coil



Test #5 - 5.39 Kg R-32, Fast Release in Air Handler (Blower "OFF")
Release rate = 2436 g/min Through a 0.070" Orifice, Near "A"-Coil

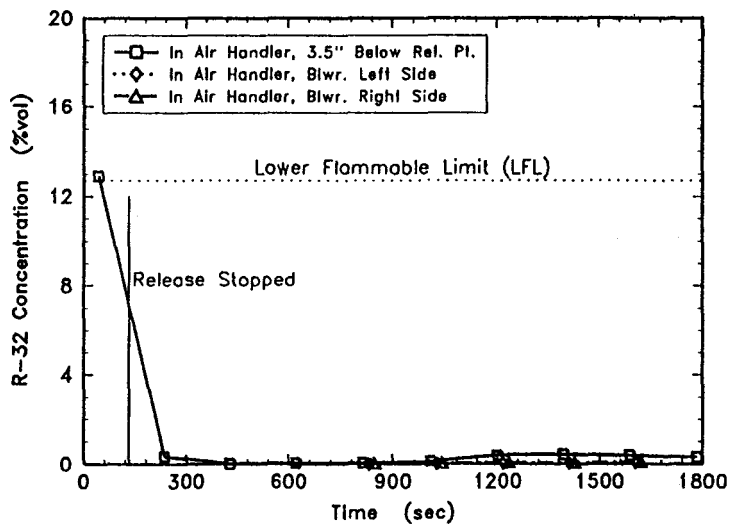

Test #5 - 5.39 Kg R-32, Fast Release in Air Handler (Blower "OFF")
Release rate = 2436 g/min Through a 0.070" Orifice, Near "A"-Coil

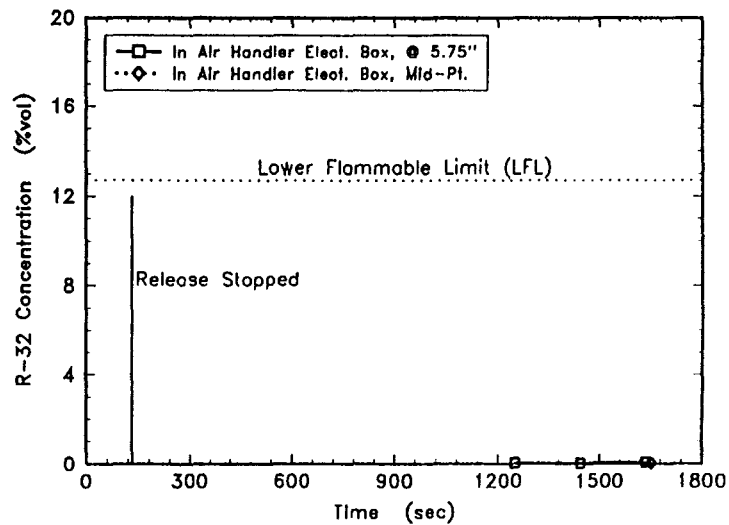

Figure 12b. Concentrations of R-32 (Fast Release into the Air Handler with Blower Off) as a Function of Time at Various Locations Inside and Outside the Air Handler.

handler (south side) and 0.076 (3 in.) above the floor. The flammable concentration at this location exceeded the LFL.

- c) **Fast Release With Air Handler Blower on:** Refer to [Figure 7](#) for detailed gas sampling locations inside the air handler, in the supply duct and away from the diffuser above the floor. [Figures 13a](#) and [13b](#) present the concentrations of R-32 as a function of time. In the first test ([figure 13a](#)), the total amount of refrigerant released was about 4.28 kg (9.44 lb). In a subsequent repeat test, the release amount was increased to about 6.74 kg (14.86 lb) ([Figure 13b](#)). The gas concentration profiles in [Figures 13a](#) and [13b](#) (both tests) show that the concentrations of R-32 were significantly lower than the LFL at the locations of gas sampling. However, it should be mentioned that estimation based on the refrigerant vapor density relative to air density indicate that the steady-state concentration values in [Figures 13a](#) and [13b](#) are not consistent with the amount of refrigerant injected into the chamber volume with the 0.42 m³/s (900 CFM) fan blowing. The estimated concentrations are about 4.5% and 5.9% by volume for test #7 ([Fig. 13a](#)) and test #8 ([Fig. 13b](#)), respectively, which are considerably greater than the concentrations reported in [Figures 13a](#) and [13b](#). Most likely, some amount of refrigerant might have been lost in the floor and beneath the aluminum pan.

3.1.3.4 Leak in Air Handler Unit inside a Closet (refer to [Figure 8](#))

- a) **Fast Release of 60%/40% by weight of R-32/R-134a:** [Figures 14a](#) and [14b](#) present the concentrations of the blend at various locations inside the air handler, in the closet and outside the closet above the floor. The LFL of the blend is not known. However, the concentrations at some locations were as high as 20-25% by volume.
- b) **Slow Release of 60%/40% by weight of R-32/R-134a:** In the case of slow release, the blend concentrations at various locations increased up to about 10%, as shown in [Figure 15](#).
- c) **Fast Release of R-32:** [Figure 16a](#) presents the R-32 concentration profiles at various locations as described in [Figure 8](#). The release amount was about 4.86 kg. (10.71 lb). At the gas sampling locations inside the air handler and closet, the concentrations reached beyond the upper flammable limit (UFL) for a short while and then dropped below the LFL. It is interesting to note, however, that concentrations at the locations outside the closet above the floor remained above the LFL for a long time. In a repeat test with a larger amount of refrigerant (5.56 kg, 12.26 lb), the identical concentration profiles were also observed in [Figure 16b](#). In this test, the concentrations were monitored for a longer period of time.

Test #7 - 4.28 Kg R-32, Fast Release In Air Handler (Blower "ON")
 Release rate = 2424 g/min Through a 0.070" Orifice, Near "A"-Coil

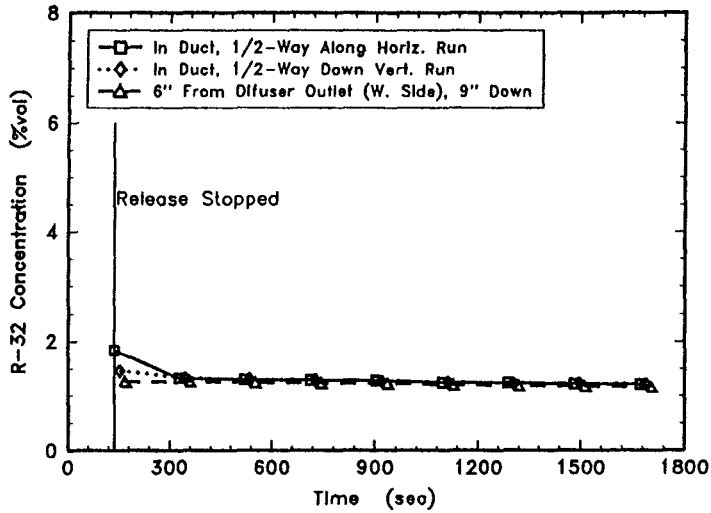

Test #7 - 4.28 Kg R-32, Fast Release In Air Handler (Blower "ON")
 Release rate = 2424 g/min Through a 0.070" Orifice, Near "A"-Coil

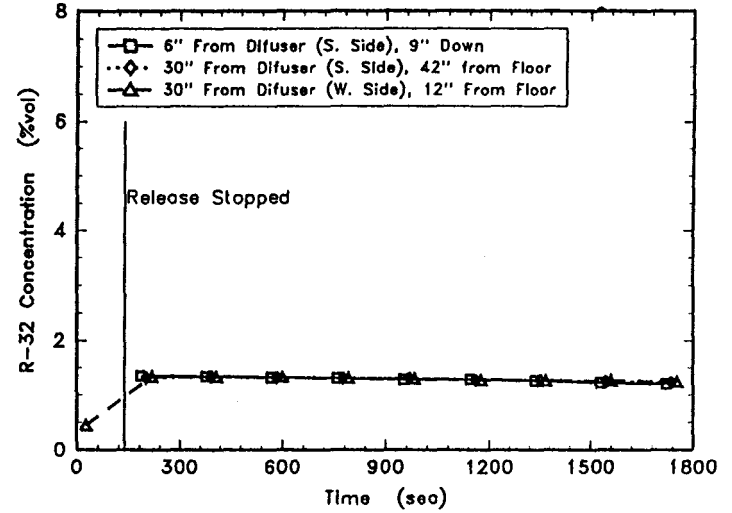

Test #7 - 4.28 Kg R-32, Fast Release In Air Handler (Blower "ON")
 Release rate = 2424 g/min Through a 0.070" Orifice, Near "A"-Coil

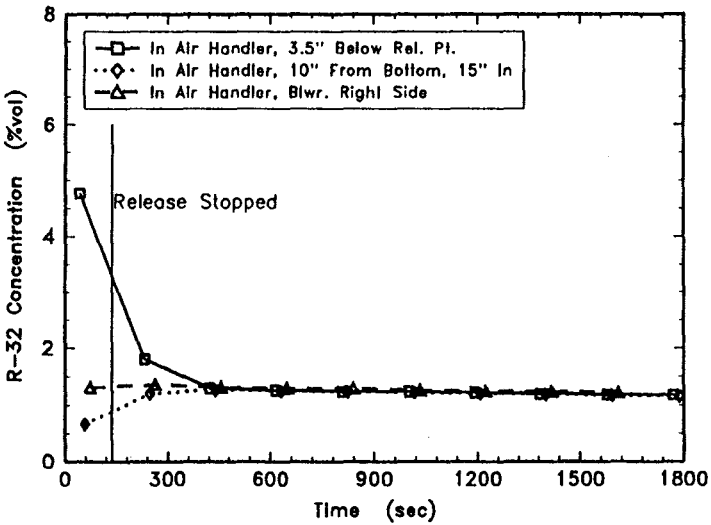

Test #7 - 4.28 Kg R-32, Fast Release In Air Handler (Blower "ON")
 Release rate = 2424 g/min Through a 0.070" Orifice, Near "A"-Coil

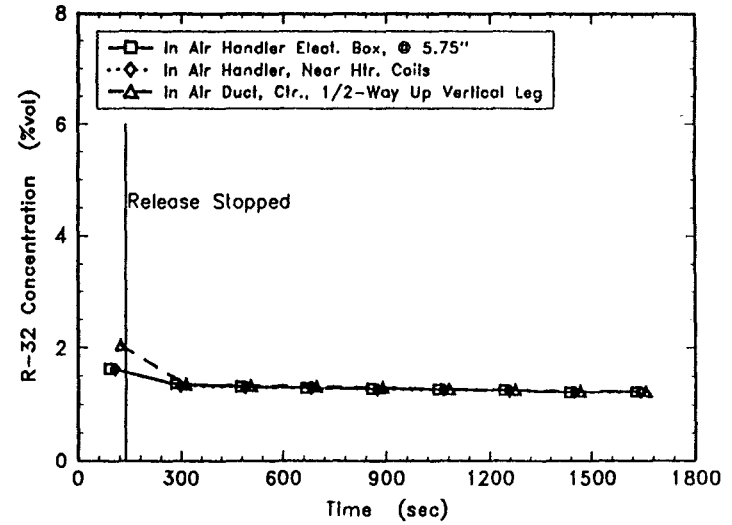
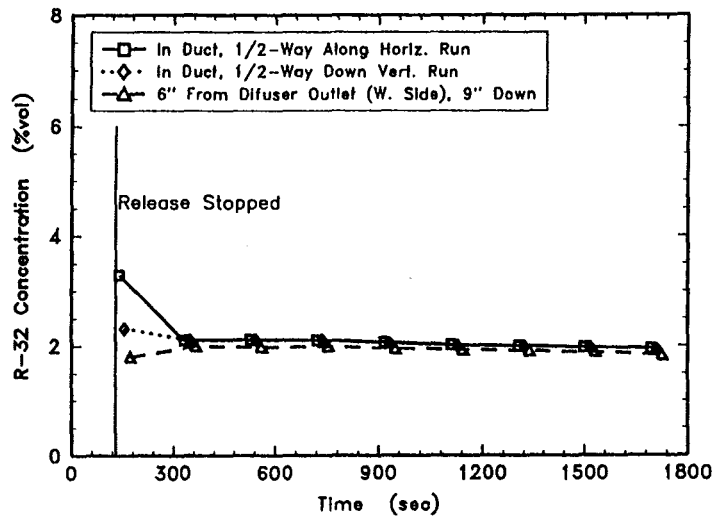
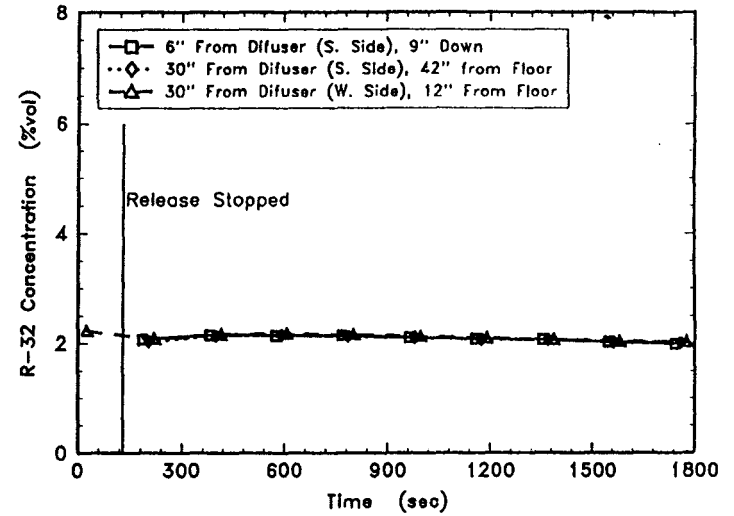

Figure 13a. Concentrations of R-32 (Fast Release into the Air Handler with Blower On) as a Function of Time at Various Locations of Gas Sampling.

Test #8 - 6.74 Kg R-32, Fast Release In Air Handler (Blower "ON")
 Release rate = 3136 g/min Through a 0.070" Orifice, Near "A"-Coil



Test #8 - 6.74 Kg R-32, Fast Release In Air Handler (Blower "ON")
 Release rate = 3136 g/min Through a 0.070" Orifice, Near "A"-Coil



Test #8 - 6.74 Kg R-32, Fast Release In Air Handler (Blower "ON")
 Release rate = 3136 g/min Through a 0.070" Orifice, Near "A"-Coil

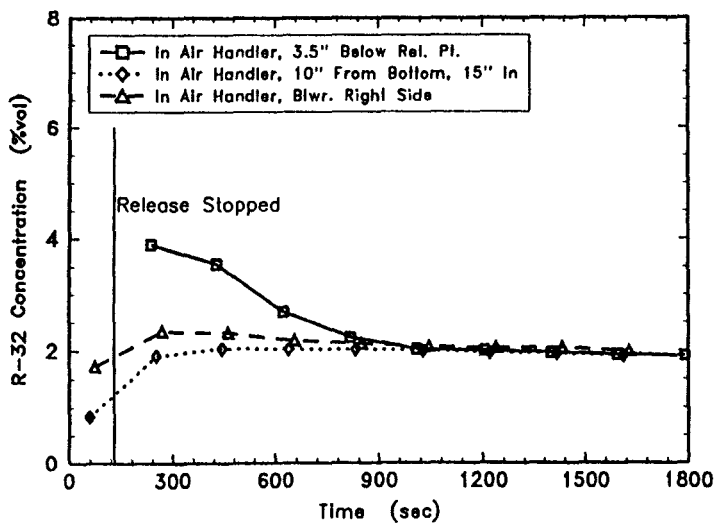

Test #8 - 6.74 Kg R-32, Fast Release In Air Handler (Blower "ON")
 Release rate = 3136 g/min Through a 0.070" Orifice, Near "A"-Coil

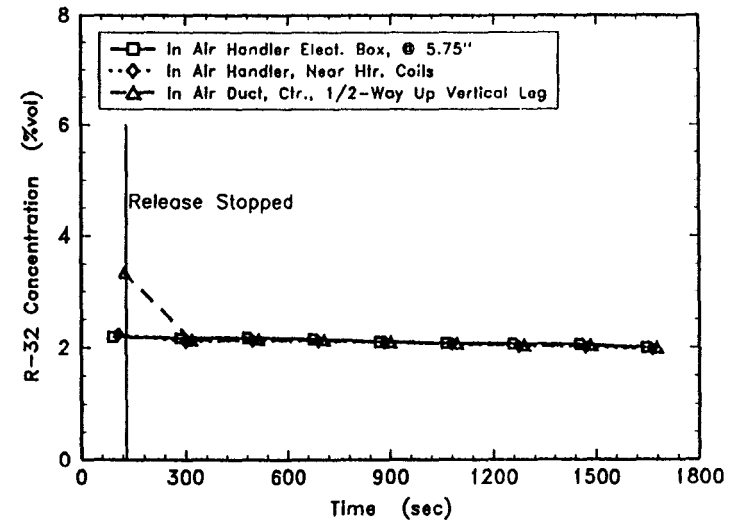
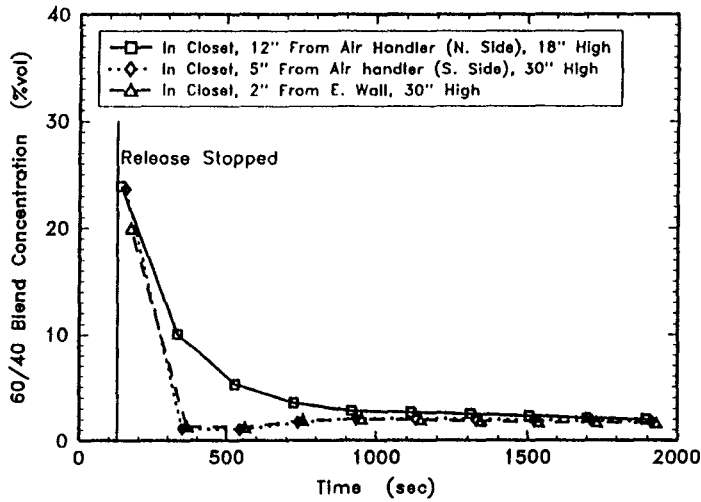
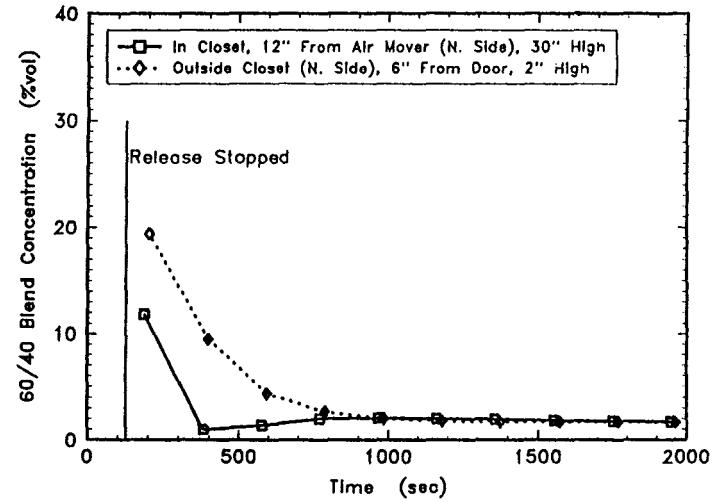

Figure 13b. Concentrations of R-32 (Fast Release into the Air Handler with Blower On) as a Function of Time At Various Locations of Gas Sampling (Repeat Test).

Test #10 - 5.56 Kg Blend, Fast Release in Air Handler (In Closet)
 Release Rate = 2666 g/min Through a 0.070" Orifice, Near "A"-Coll



Test #10 - 5.56 Kg Blend, Fast Release in Air Handler (In Closet)
 Release Rate = 2666 g/min Through a 0.070" Orifice, Near "A"-Coll



Test #10 - 5.56 Kg Blend, Fast Release in Air Handler (In Closet)
 Release Rate = 2666 g/min Through a 0.070" Orifice, Near "A"-Coll

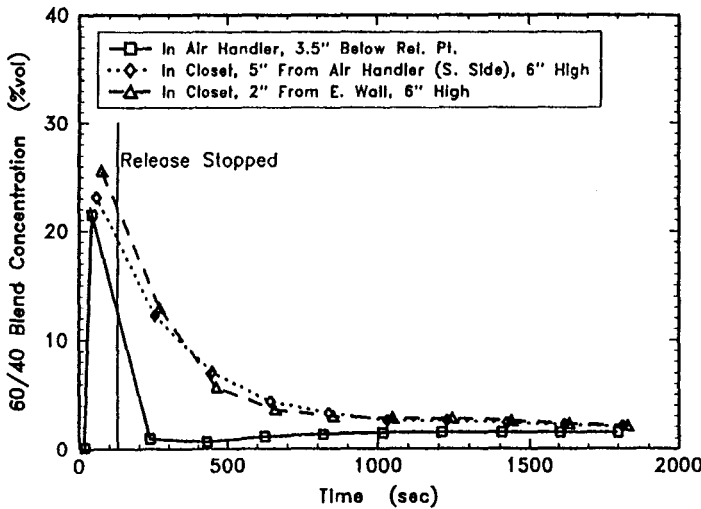

Test #10 - 5.56 Kg Blend, Fast Release in Air Handler (In Closet)
 Release Rate = 2666 g/min Through a 0.070" Orifice, Near "A"-Coll

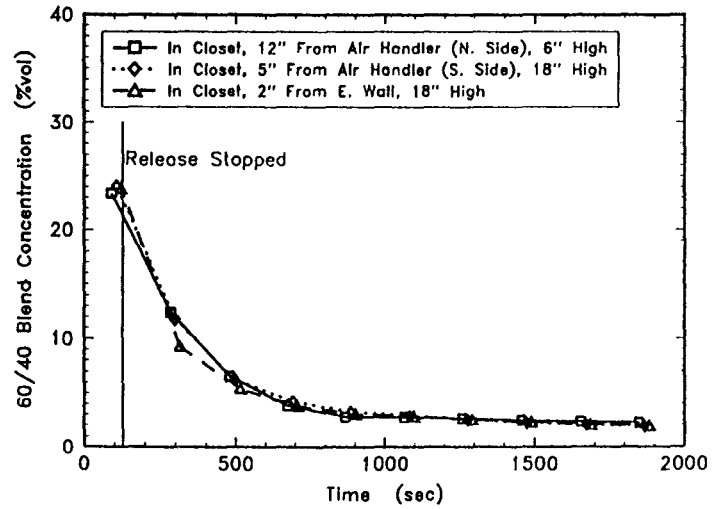
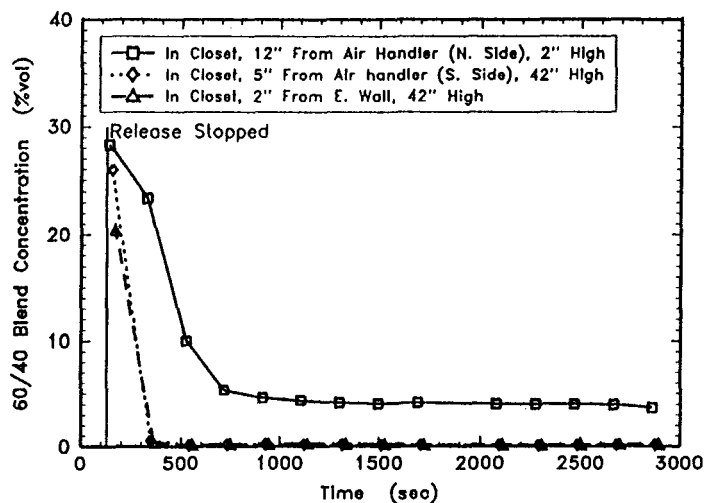
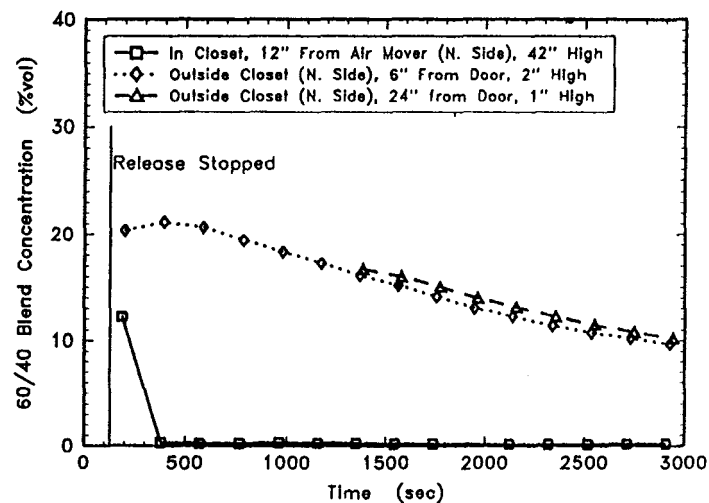

Figure 14a. Concentrations of 60%/40% of R-32/R-134a (Fast Release into the Air Handler Inside a Closet) at Various Locations Inside the Air Handler, in the Closet and outside the Closet above the Floor.

Test #11 - 5.35 Kg Blend, Fast Release in Air Handler (In Closet)
 Release Rate = 2529 g/min Through α 0.070" Orifice, Near "A"-Coll



Test #11 - 5.35 Kg Blend, Fast Release in Air Handler (In Closet)
 Release Rate = 2529 g/min Through α 0.070" Orifice, Near "A"-Coll



Test #11 - 5.35 Kg Blend, Fast Release in Air Handler (In Closet)
 Release Rate = 2529 g/min Through α 0.070" Orifice, Near "A"-Coll

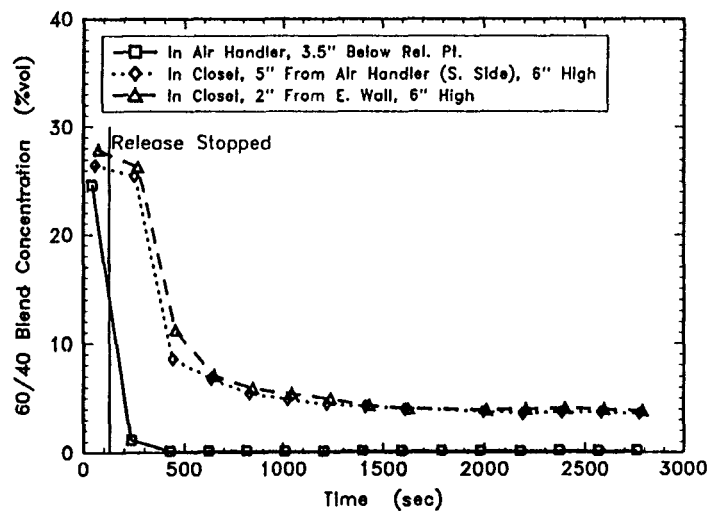

Test #11 - 5.35 Kg Blend, Fast Release in Air Handler (In Closet)
 Release Rate = 2529 g/min Through α 0.070" Orifice, Near "A"-Coll

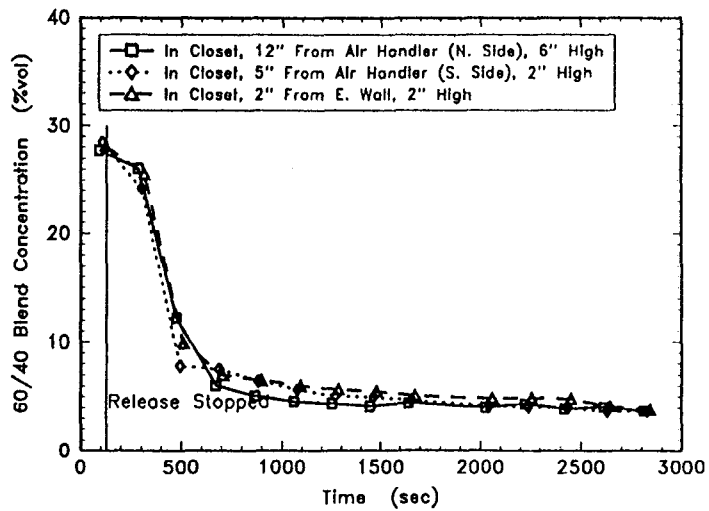
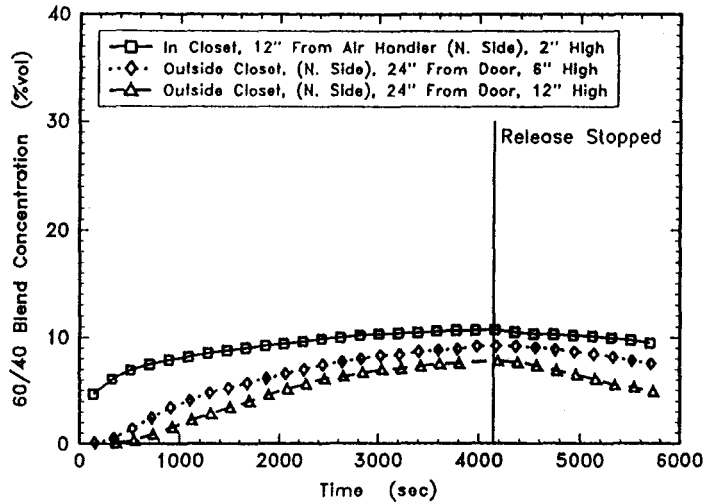
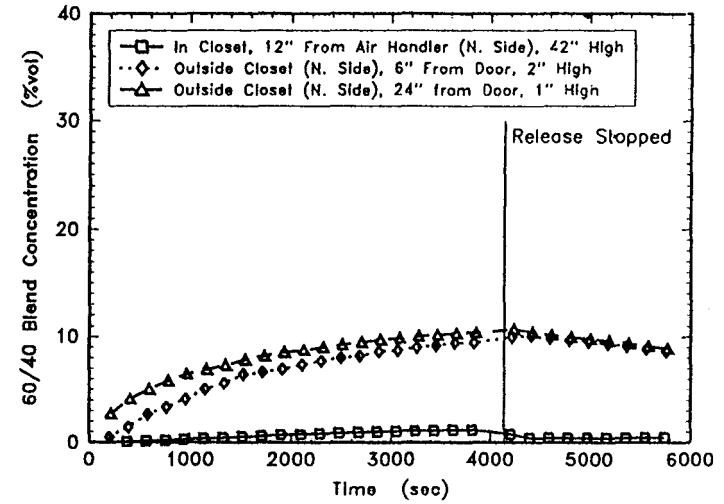

Figure 14b. Concentrations of 60%/40% of R-32/R-134a (Fast Release into the Air Handler Inside a Closet) at Various Locations Inside the Air Handler, in the Closet and Outside the Closet Above the Floor

Test #12 - 5.47 Kg Blend, Slow Release in Air Handler (In Closet)
Release Rate = 79 g/min Through Heat Exchanger System, Near "A"-Coll



Test #12 - 5.47 Kg Blend, Slow Release in Air Handler (In Closet)
Release Rate = 79 g/min Through Heat Exchanger System, Near "A"-Coll



Test #12 - 5.47 Kg Blend, Slow Release in Air Handler (In Closet)
Release Rate = 79 g/min Through Heat Exchanger System, Near "A"-Coll

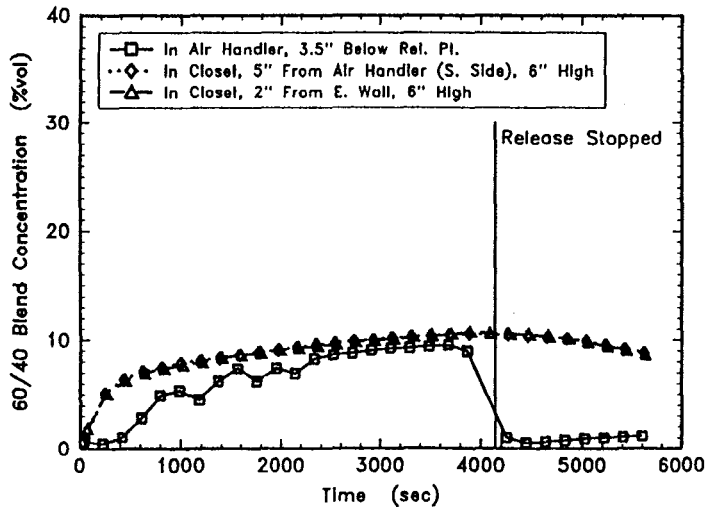

Test #12 - 5.47 Kg Blend, Slow Release in Air Handler (In Closet)
Release Rate = 79 g/min Through Heat Exchanger System, Near "A"-Coll

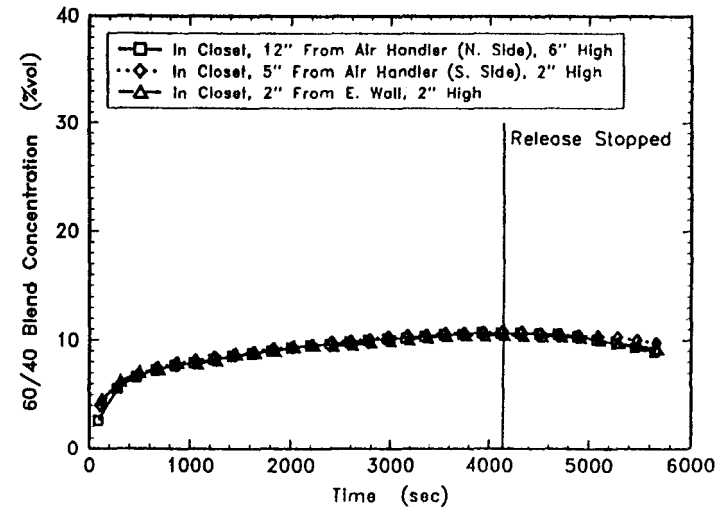
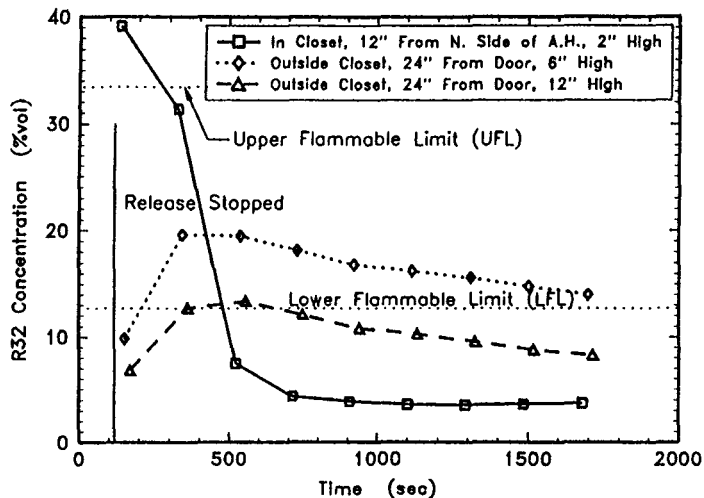
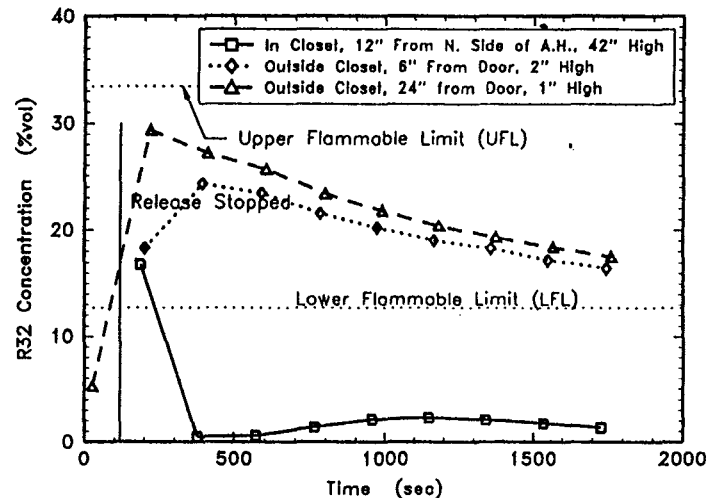

Figure 15. Concentrations of 60%/40% of R-32/R-134a (Slow Release into the Air Handler Inside a Closet) at Various Locations Inside the Air Handler, in the Closet and Outside the Closet Above the Floor

Test #13 - 4.86 Kg R32, Fast Release in Air Handler (In Closet)
 Release Rate = 2470 g/min Through 0.070" Orifice, Near "A"-Coil



Test #13 - 4.86 Kg R32, Fast Release in Air Handler (In Closet)
 Release Rate = 2470 g/min Through 0.070" Orifice, Near "A"-Coil



Test #13 - 4.86 Kg R32, Fast Release in Air Handler (In Closet)
 Release Rate = 2470 g/min Through 0.070" Orifice, Near "A"-Coil

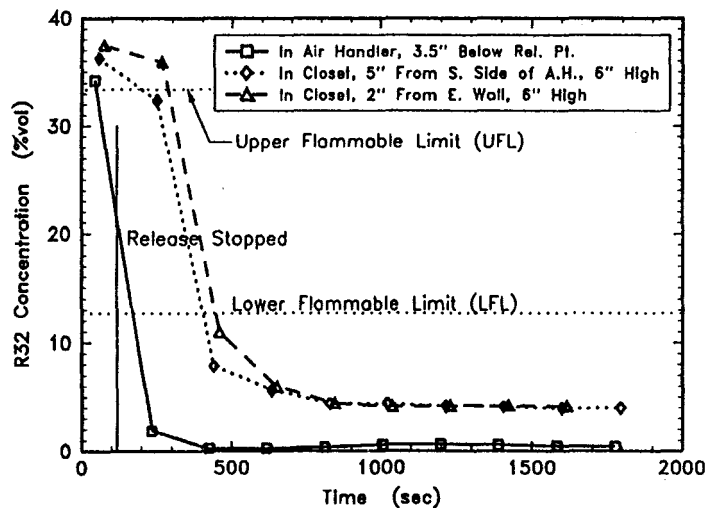

Test #13 - 4.86 Kg R32, Fast Release in Air Handler (In Closet)
 Release Rate = 2470 g/min Through 0.070" Orifice, Near "A"-Coil

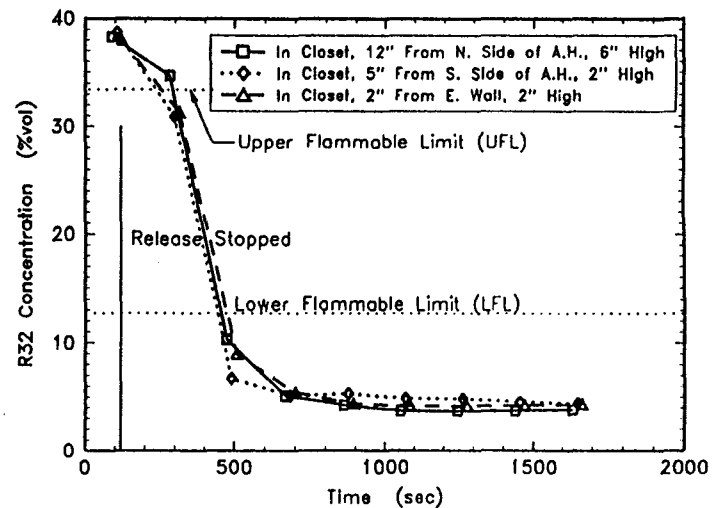
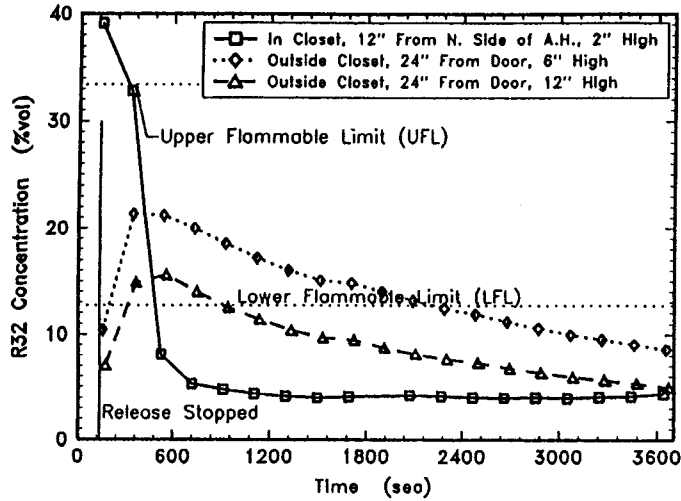
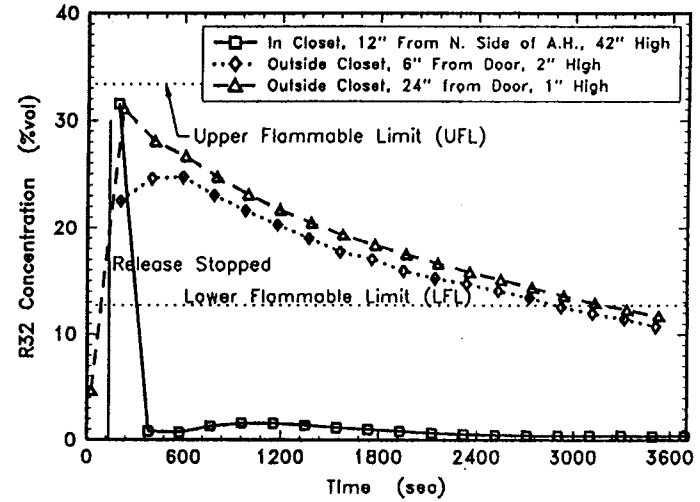

Figure 16a. Concentrations of R-32 (Fast Release into the Air Handler Inside a Closet) at Various Locations Inside the Air Handler, in the Closet and Outside the Closet Above the Floor.

Test #14 - 5.58 Kg R-32, Fast Release In Air Handler (In Closet)
 Release Rate = 2554 g/min Through 0.070" Orifice, Near "A"-Coil



Test #14 - 5.58 Kg R-32, Fast Release In Air Handler (In Closet)
 Release Rate = 2554 g/min Through 0.070" Orifice, Near "A"-Coil



Test #14 - 5.58 Kg R-32, Fast Release In Air Handler (In Closet)
 Release Rate = 2554 g/min Through 0.070" Orifice, Near "A"-Coil

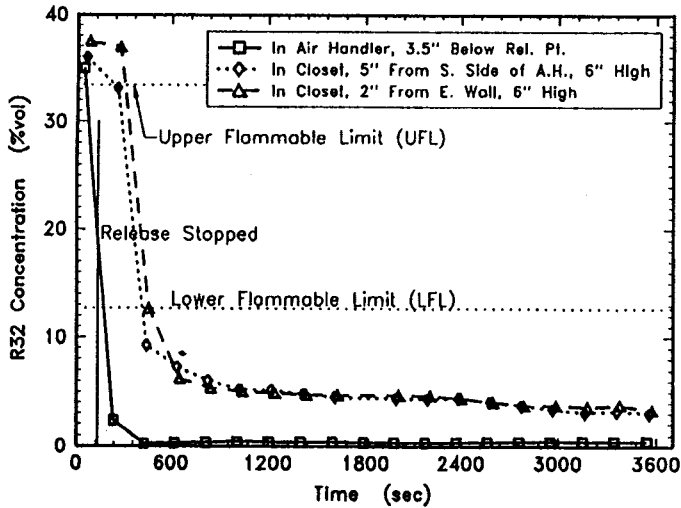

Test #14 - 5.58 Kg R-32, Fast Release In Air Handler (In Closet)
 Release Rate = 2554 g/min Through 0.070" Orifice, Near "A"-Coil

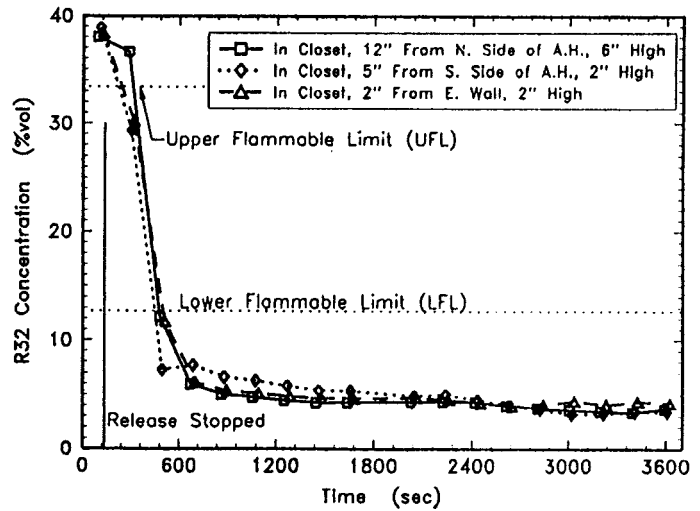

Figure 16b. Concentrations of R-32 (Fast Release into the Air Handler Inside a Closet) at Various Locations Inside the Air Handler, in the Closet and Outside the Closet Above the Floor

3.2 Ignition Tests

All the ignition tests were conducted with R-32. All tests were performed in a quiescent environment. No blowers were used. See section 3.2.1 for ignition test sequence.

3.2.1 Ignition Test Sequence

The following ignition tests were conducted:

<u>Test Type</u>	<u>Test Conditions</u>	<u>Test No.</u>
* Leak in Air Handler Unit inside a closet with blower off	Fast Release of R-32 with two gas pilots inside the closet and one 15 kV arc outside the closet	#1
* Leak in Air Handler Unit inside a closet with blower off	Fast Release of R-32 with one electrical coil of the air handler energized and two gas pilots outside the closet	#2
* Room leak in quiescent environment	Slow Release of R-32 with three gas pilots	#3
* Room leak in quiescent environment	Slow Release of R-32 with one 15 kV arc igniter	#4
* Room leak in quiescent environment	Fast Release of R-32 with three gas pilots	#5
* Room leak in quiescent environment	Very Slow Release of R-32 with three gas pilots	#6
* Room leak in quiescent environment	Slow Release of R-32 with three 15 kV arc igniters	#7
Leak in the duct in quiescent environment	Fast Release of R-32 with three 15 kV arc igniters	#8
Leak in the duct in quiescent environment	Slow Release of R-32 with three 15 kV arc igniters	#9
Room leak with an obstacle in quiescent environment	Very Slow Release of R-32 with three gas pilots	#10

* Repeats of concentration mapping tests.

3.2.2 Test Configurations and Results

The ignition tests were designed based on the concentration mapping results. The test chamber was configured to allow for ignition tests, representing several leak scenarios as for the concentration mapping tests. These scenarios reproduced refrigerant leaks into four different spaces: an empty room, a room with an obstacle, the air handler with a closet and a vertical duct (simulating a leak inside the duct, which spreads to the room through the diffuser). The ignition sources (propane pilots and 15 kV arc igniters) were placed at the locations where flammable concentrations of R-32 were observed in the concentration mapping tests. The ignition sources were kept on while the leak proceeded as well as after it ended and continued for 30 minutes to 5 hours, depending on the tests with fast, slow and very slow refrigerant releases. The detailed configurations and test results are described below.

3.2.2.1 Leak in Air Handler Unit Inside a Closet - [Figure 17](#) presents the refrigerant release point and igniters locations for ignition tests. Similar to the concentration mapping tests, the refrigerant release tube was placed close to the A-coil of the air handler. Refer to [Figures 16a](#) and [16b](#) for concentration profiles at various locations (see [section 3.1.3.4c](#)). The exact locations and type of ignition sources used in the tests are described below.

- a) Test #1, Fast Release (~2500 g/min, 5.51 lb/min): Two gas pilots were placed inside the closet. One was 0.203 m (8 in.) from the east side of the air handler, 0.076 m (3 in.) above the floor and centered in the air handler. The other one was placed 0.305 m (1 ft) from the north side of the air handler (centered) 0.076 m (3 in.) above the floor ([Fig. 17](#)). One 15 kV arc igniter was located outside the closet, 0.305 m (1 ft) from the door (centered) 0.076 m (3 in.) above the floor.

A brief ignition was observed from the gas pilots inside the closet. The flame extinguished itself. However, at the location outside the closet, a sustained flame was developed by the arc igniter, which was contained to an area around the closet door and the east side wall of the chamber (see [Fig. 17](#)).

- b) Test #2, Fast Release (~2500 g/min, 5.51 lb/min): This test was conducted with one of the four heater coils in the air handler (beneath the outlet duct) energized with 230 VAC. Two gas pilot igniters were located outside the closet (north side), both 0.076 m (3 in.) above the floor, one 0.305 m (1 ft) from the door (on the centerline) and the other one 0.305 m (1 ft) from the door centerline (west side).

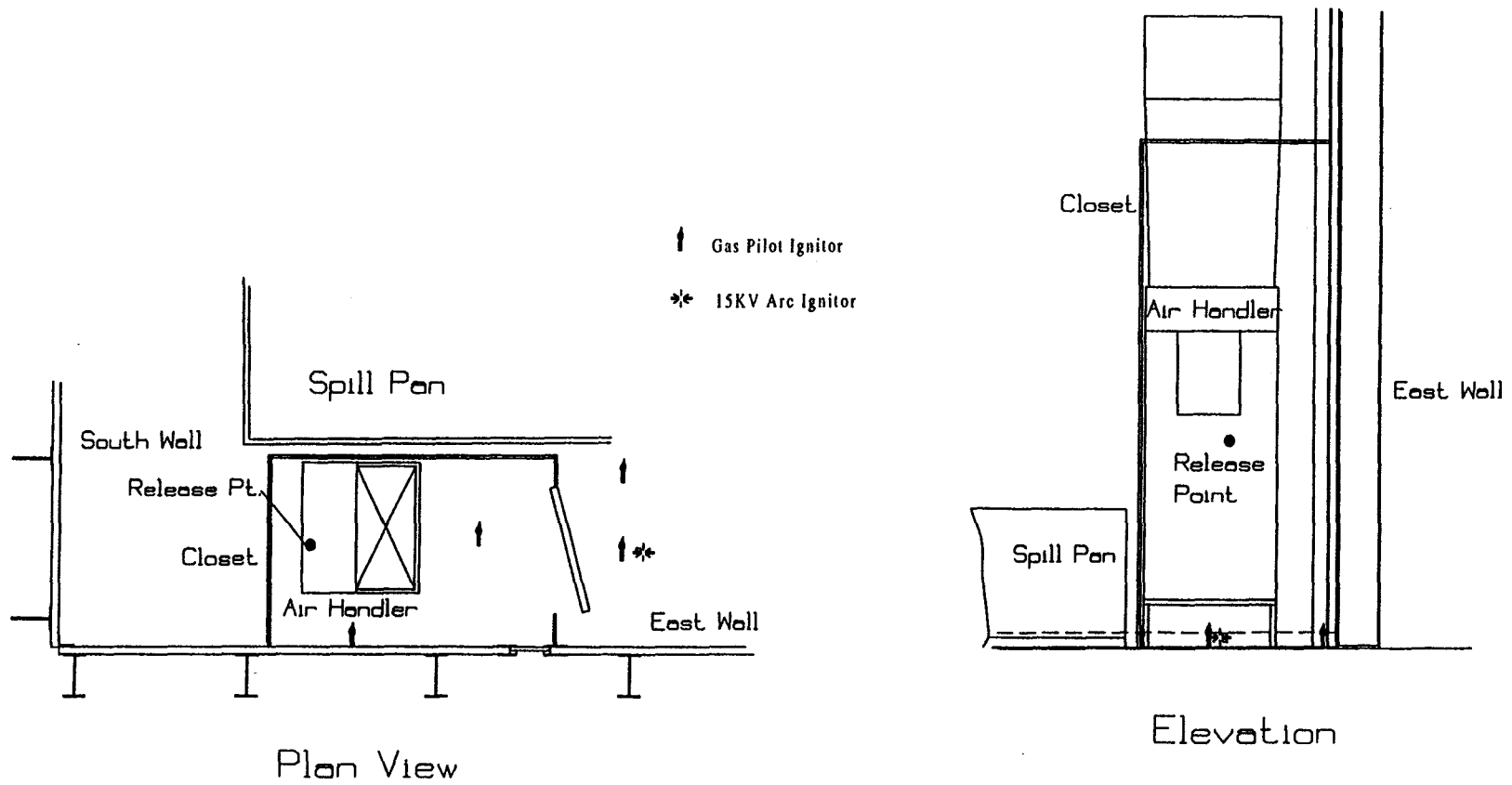

Figure 17. Release and Igniters Locations for Releases in Air Handler Inside a Closet

No ignitions were observed inside the closet. There were sustained flames around the two gas pilots outside the closet door. The flames remained contained to the area around the closet door and east side of the pan lip. The flames lasted about 4 min.

3.2.2.2 Leak into a Room - Tests were conducted in the pan inside the test chamber, as shown in [Figure 18](#). The refrigerant was released at approximately 0.305 m (1 ft) from the corner and 0.305 m (1 ft) from the floor of the pan. The release point was directed towards the floor of the pan.

In one test, the release point was placed 0.457 m (1.5 ft) above the pan. Three gas (propane) pilots (each about 25.4 mm (1 in.) flame length) and three 15 kV continuous arcs were used as ignition sources. The exact locations of these ignition sources are described below for each individual test.

a) Test #3, Slow Release (80-90 g/min, 0.18 – 0.20 lb/min): As shown in [Figure 18](#), three gas pilots were positioned in the pan, 0.076 m (3 in.) above the pan floor respectively, 0.305 m (1 ft) and 1.22 m (4 ft) away from the release point on the diagonal line, and 1.22 m (4 ft) from the release point near the pan edge (south side). Refer to [Figures 10a](#) and [10b](#) for concentration profiles at various locations (see [section 3.1.3.1b](#)).

Two pilots were quickly blown out as the release proceeded. No ignition was observed. The pilot at the edge of the pan slowly burned off flammable concentrations of R-32 with a small flame both during release of the refrigerant and after its completion.

b) Test #4, Slow Release (80-90 g/min) (0.18 - 0.20 lb/min): One 15kV arc igniter was placed 0.305 m (1 ft) away from the release point on the diagonal line and 0.076 m (3 in.) above the floor of the pan (refer to [Fig. 18](#)). Concentration profiles at various locations are presented in [Figures 10a](#) and [10b](#) (see [section 3.1.3.1b](#)).

Repeated ignitions and flames were observed at the arc igniter location. The flames traveled back to the release point and self-extinguished.

c) Test #5, Fast Release (~2500 g/min, 5.51 lb/min): Same configurations as test #3. See [Figures 9a](#) and [9b](#) for concentration profiles at various locations ([Section 3.1.3.1a](#)). No ignitions were observed.

d) Test #6, Very Slow Release (15-66 g/min, 0.033 – 0.14 lb/min): Same configurations as test #3. No ignitions were observed. Only small continuous flames around the pilots were observed as the release proceeded.

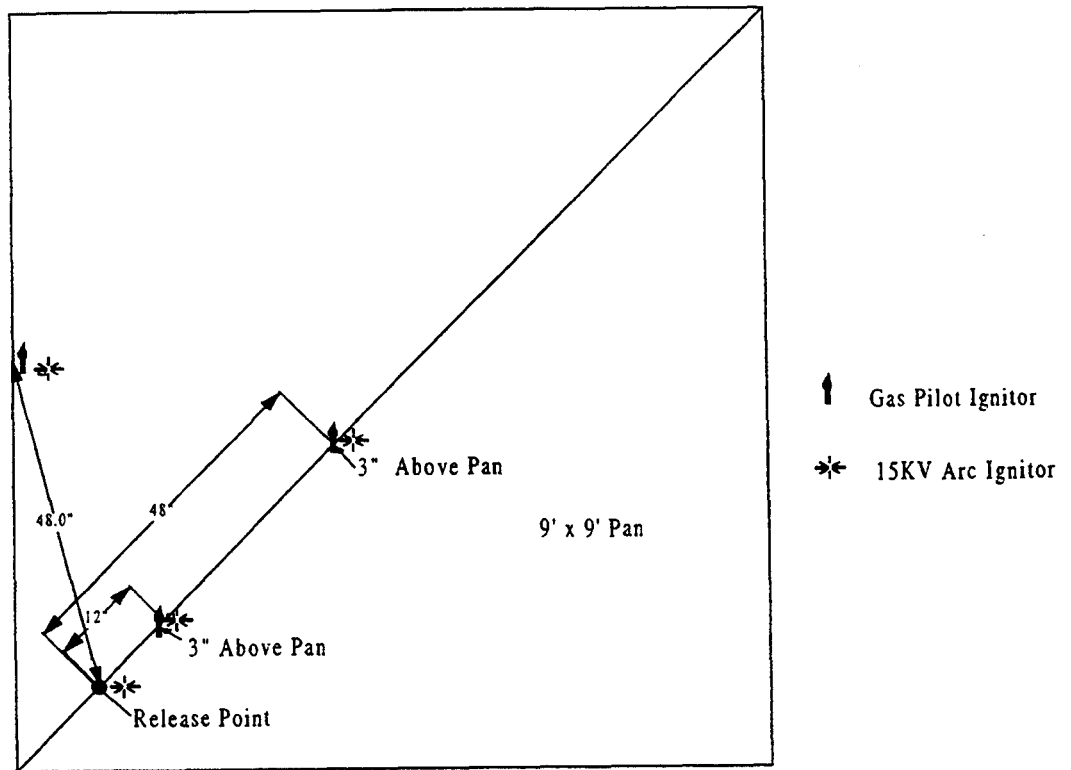

Figure 18. Release Point and Igniters Locations for Pan Ignition Tests

e) Test #7, Slow Release (80-90 g/min, 0.18 – 0.20 lb/min): The refrigerant release point was placed approximately 0.305 m (1 ft) from the corner and 0.457 m (1.5 ft) above the pan floor. Three 15 kV arc igniters were located in the pan, one directly below the release point, one at 0.305 m (1 ft) and one at 0.61 m (2 ft) away from the release point on the diagonal line. All igniters were 0.076 m (3 in.) above the pan floor (see Fig.18). Repeated ignitions and flames were observed at the first arc igniter, which was directly below the release point. The flames traveled back to the release point and self extinguished. This phenomenon continued throughout the test period.

3.2.2.3 Leak in the Duct - A 1.22 m (4 ft) long vertical duct, 0.305 by 0.61 m (12 by 24 in.), with a diffuser attached, 0.762 by 0.762 m, (30 by 30 in.) was installed on the chamber ceiling centered on the pan (1.73 m (68 in.) above the pan) and is shown in Figure 19a. The plan view is shown in Figure 19b. The refrigerant was released at the top of the duct. The locations of ignition sources are described below for each test.

- a) Test #8, Fast Release (~2500 g/min, 5.51 lb/min): Three 15 kV arc igniters were placed directly below the diffuser: two 0.076 m (3 in.) off the pan floor (one at dead center and one at 0.457 m (18 in.) off the center of the diffuser), and one 0.457 m (18 in.) off center of the diffuser at a height of about 0.864 m (34 in.) (half way between the pan floor and the bottom of the diffuser). No ignitions were observed.
- b) Test #9, Slow Release (150 g/min, 0.33 lb/min): Same configurations as in Test #8. No ignitions were observed.

3.2.2.4 Room Leak with Obstacle - Figure 20 presents the detailed test set up. The test was conducted by releasing the refrigerant into the pan with three gas pilot igniters and an obstacle. The refrigerant release point was placed at 2.06 m (6 ft 9 in.) from the west edge and 0.152 m (6 in.) from the south edge of the pan. The release point was directed at an angle 45 degree downward towards the west side of the pan. The detailed test configuration is described below.

- a) Test #10, Slow Release (<30 g/min, 0.066 lb/min): Three gas pilots, all 0.076 m (3 in.) above the pan and 0.152 m (6 in.) from the south pan edge, were located at 0.61 m (2 ft) intervals away from the release point. An obstacle made of sheet metal, 0.457 m (18 in.) wide and 0.61 m (24 in.) high was placed 0.305 m (1 ft) from the south pan edge. Note that one gas pilot was located in a “blind alley.” The two pilots close to the release point

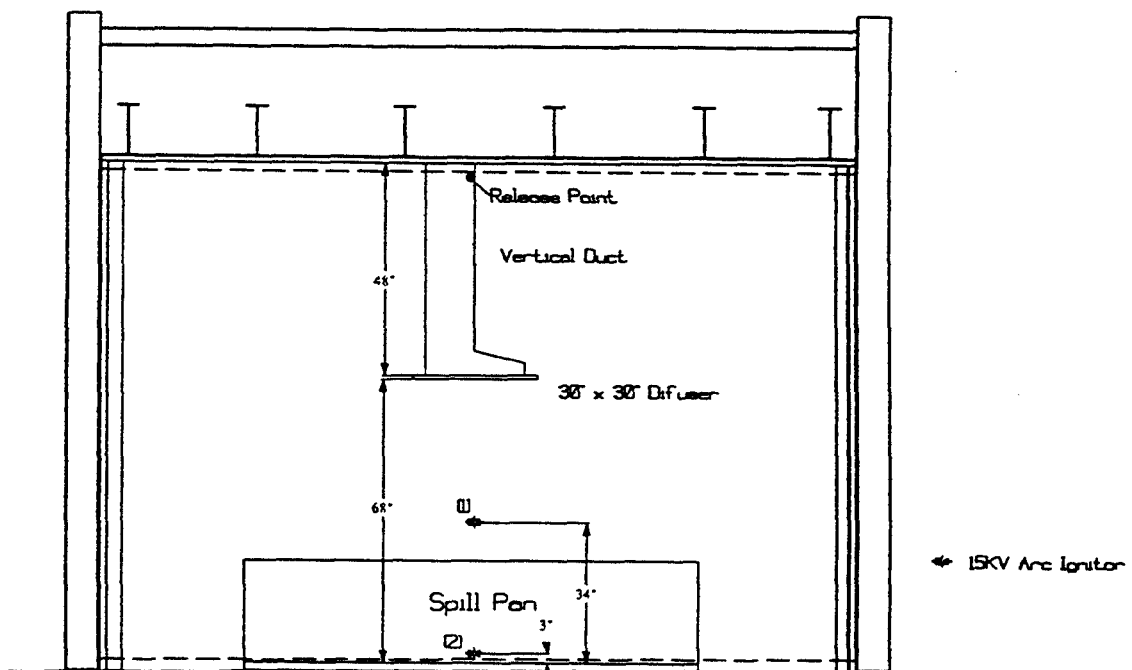

Figure 19a. Release Point and Igniters Locations - Duct Release Test (Elevation-Looking North).

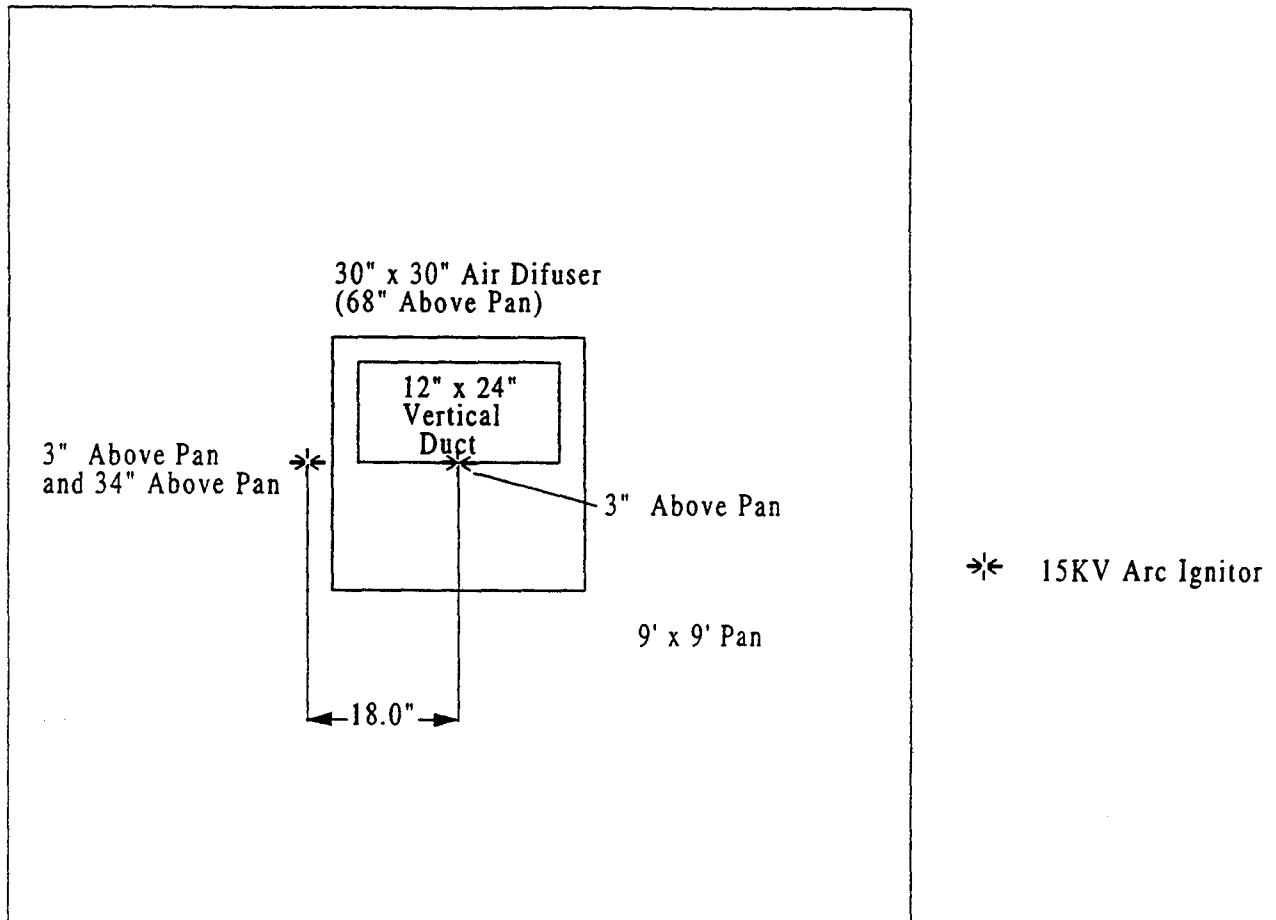

Figure 19b. Igniters Locations for Duct Release (Plan View).

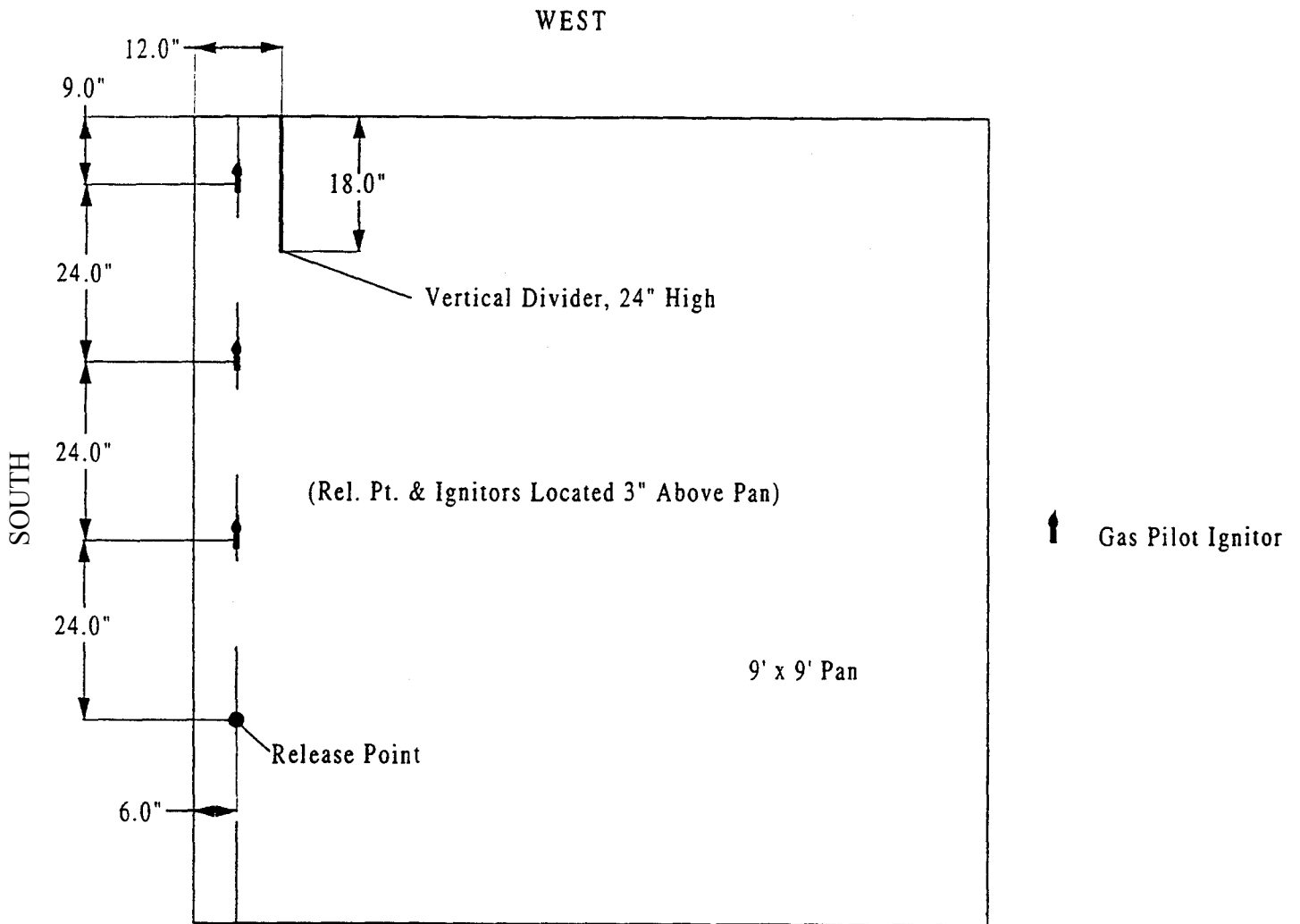

Figure 20. Release Point and Igniters Locations: Pan Ignition Test with an Obstacle.

were blown out as the release proceeded. No ignitions were observed. Only a small continuous flame was observed around the pilot close to the obstacle during the release and after the refrigerant release ended.

IV**CONCLUSIONS**

Based on the large-scale tests conducted in this program, the following conclusions can be made:

- a) The slow release (vapor release) of R-32 refrigerant into a pan (simulating a room) in quiescent environment produced flammable concentration (greater than the LFL) regions at elevations of 0.076 m (3 in.) and up to 0.305 m (12 in.) as far as 2.44 m (8 ft) away from the release point. Ignitions could not be achieved in the flammable regions by placing propane gas pilots. However, when a strong electrical source was used, such as a 15 kV arc igniter, ignition was observed.
- b) The fast release (two phase jet release) of R-32 into the room in a quiescent environment generated refrigerant concentrations which were significantly lower than the LFL in the same regions as stated above. As expected, no ignitions were observed with three gas pilots.
- c) The fast release of R-32 in the A-coil of the air handler unit inside a closet (with blower off) produced momentarily flammable concentration inside the closet (near the release point and at 0.152 m (6 in.) above the floor, then dropped below the LFL. The concentration outside the closet 0.152 m (6 in.) above the floor, however, remained above the LFL. While a brief ignition was observed inside the closet from the gas pilots placed at the locations 0.076 m (3 in.) above the floor, sustained flames developed around the arc igniter and around the gas pilot (in two separate tests using each igniter at a time), located outside the closet (0.305 m (1 ft) away and 0.076 m (3 in.) above the floor.
- d) The fast release of R-32 in the air handler (without closet) with the blower on produced concentrations at the locations inside the air handler, in the supply duct and away from the diffuser above the floor, significantly lower than the LFL.
- e) Fast and slow releases of R-32 into a vertical duct (simulating a leak inside the duct, which spreads to the room through the diffuser) did not produce ignitions with three 15 kV arc igniters placed directly below 0.457 m (18 in.) and 0.864 m (34 in.) away from the duct diffuser in the chamber.
- f) The outdoor leak, simulated by releasing R-32 refrigerant at a slow rate with air blowing from a fan $0.017 \text{ m}^3/\text{s}$ (36 CFM) behind the release point, kept the flammable concentrations below the LFL, at elevations of 0.152 to 0.914 m (6 in. to 3 ft), and 0.305, 1.22 and 2.44 m (1, 4, and 8 ft) away from the release point.

- g) The fast release of 60%/40% of an R-32/R-134a blend into the air handler unit inside the closet (with blower off) produced concentrations as high as 20-25% by volume at various locations inside the air handler, in the closet, and outside the closet above the floor.
- h) Under similar conditions as above, the same blend in a slow release produced concentrations up to 10% by volume.

V

REFERENCES

1. ASHRAE. 1992. Number Designation and Safety Classification of Refrigerants, Standard 34-1992. Atlanta, GA: American Society of Heating, Refrigerating and Air-Conditioning Engineers, Inc.
2. Calm, J.M., "Refrigerants and Lubricants - Data for Screening and Application", 1995 International CFC and Halon Alternatives Conference, Conference Proceedings.
3. Atwood, T., "HFC 32 ... Part of the "New Math" of Refrigerants", 1991 International CFC and Halon Alternatives Conference, Conference Proceedings.
4. Creazzo, J.A., Hammel, H.S., "Replacing CFC-11 with HCFC-22 in Polyurethane Foam," 1991 International CFC and Halon Alternatives Conference, Conference Proceedings.

12. Appendix C: Fault Trees

1. Fire in Basement/Garage (Rev1)

(A) For each Ignition source listed we considered (i) the effect of ventilation on dispersing the leak (ii) the likelihood the ignition source is on/present (iii) the likelihood that leak reaches ignition source in a flammable concentration.

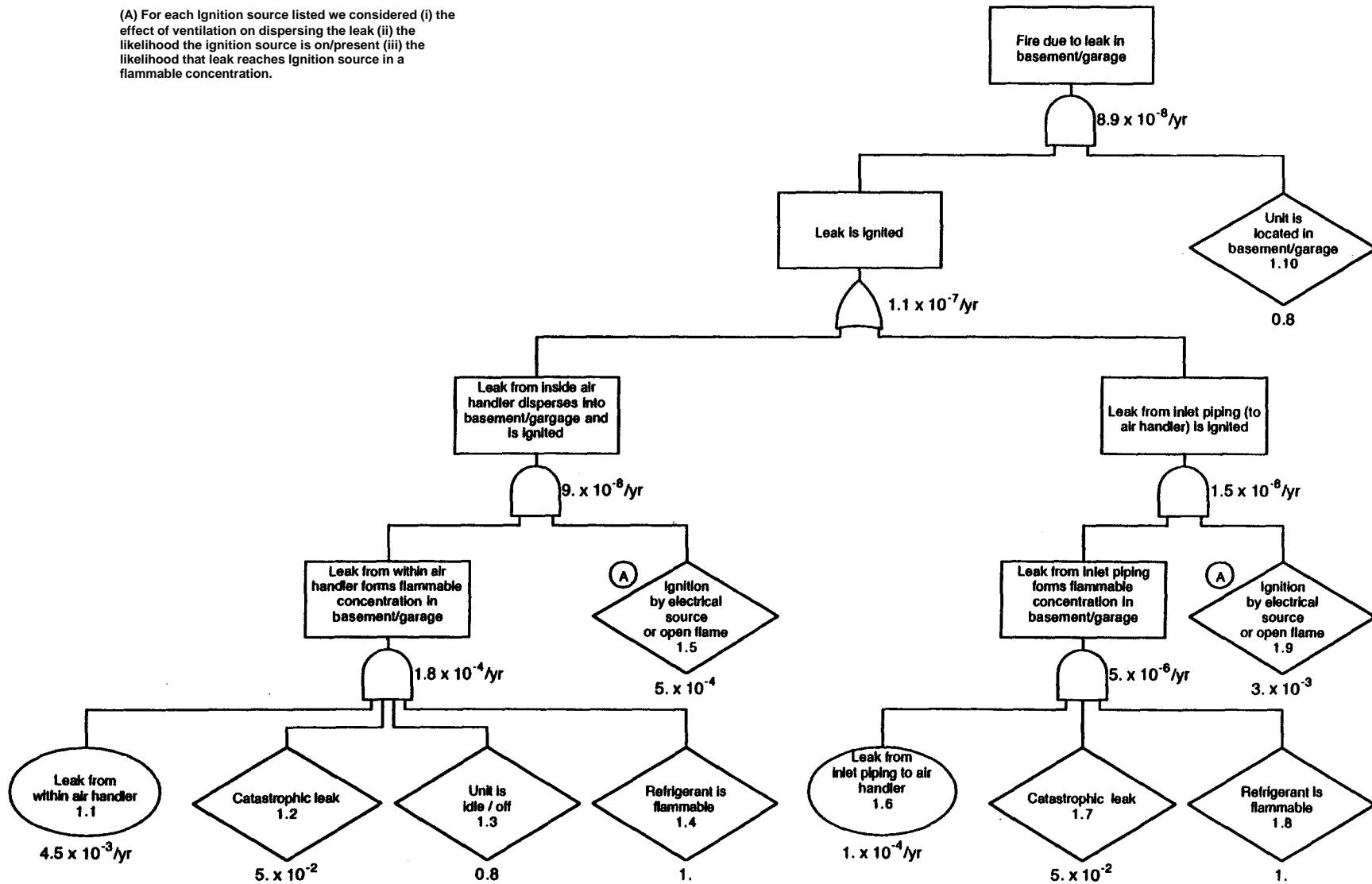

Possible electrical ignition sources in basement/garage:

- oil furnace sparkler ignitor
- high voltage electrical spark
- broken light bulb

Possible open flame ignition sources in basement/garage:

- match / lighter
- pilot light (clothes dryer, water heater, furnace)
- flame (clothes dryer, water heater, furnace)
- fuel fired space heater
- propane torch

2. Fire in Attic (Rev 1)

(A) For each ignition source listed we considered (i) the effect of ventilation on dispersing the leak (ii) the likelihood the ignition source is on/present (iii) the likelihood that leak reaches ignition source in a flammable concentration.

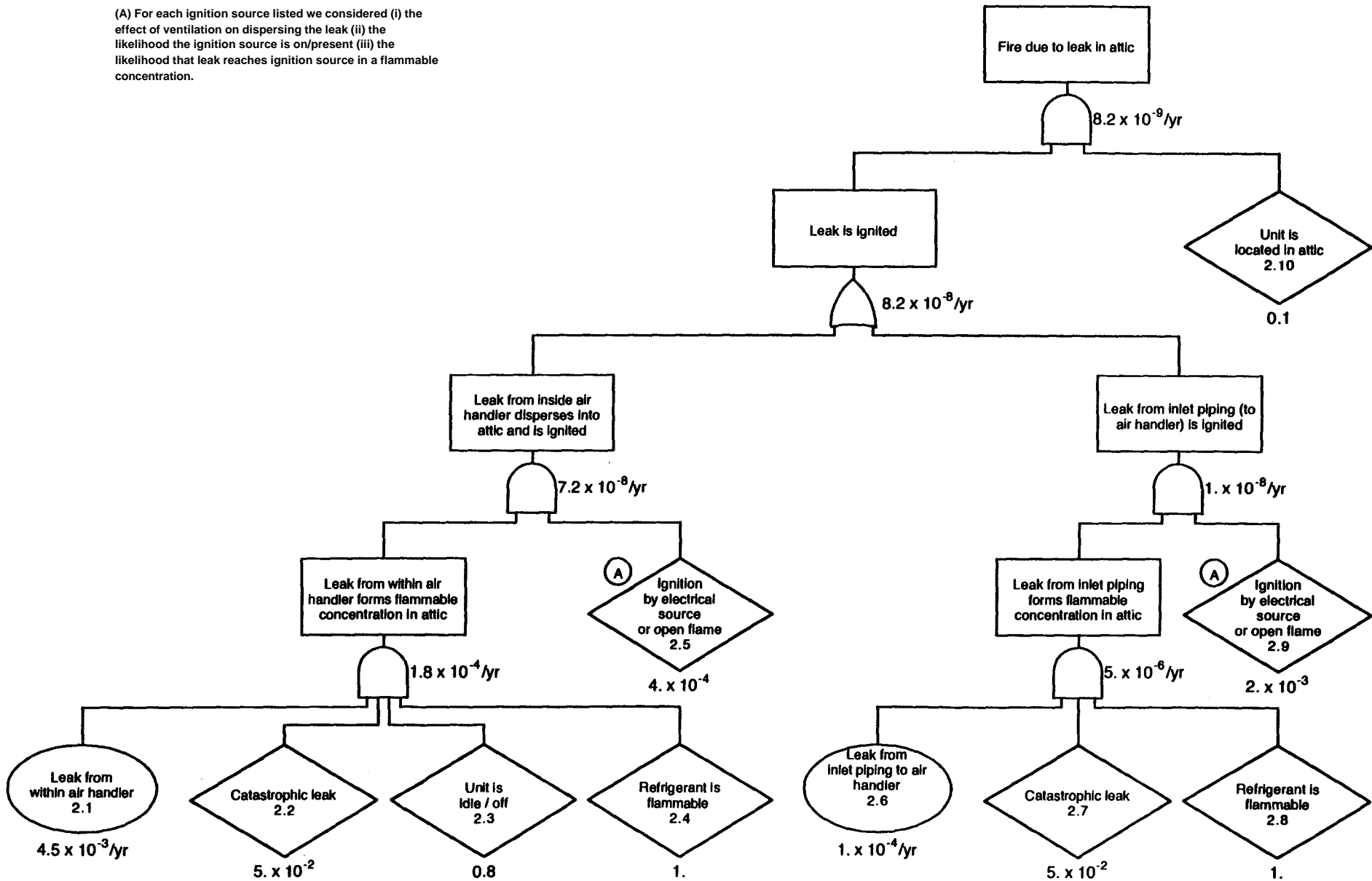

Possible electrical Ignition sources In attic:

- high voltage electrical spark
- broken light bulb

Possible open flame ignition sources In attic:

- pilot light (water heater)
- flame (water heater)

3. Fire in Closet (Rev1)

(A) For each Ignition source listed we considered (i) the effect of ventilation on dispersing the leak (ii) the likelihood the ignition source is on/present (iii) the likelihood that leak reaches ignition source in a flammable concentration.

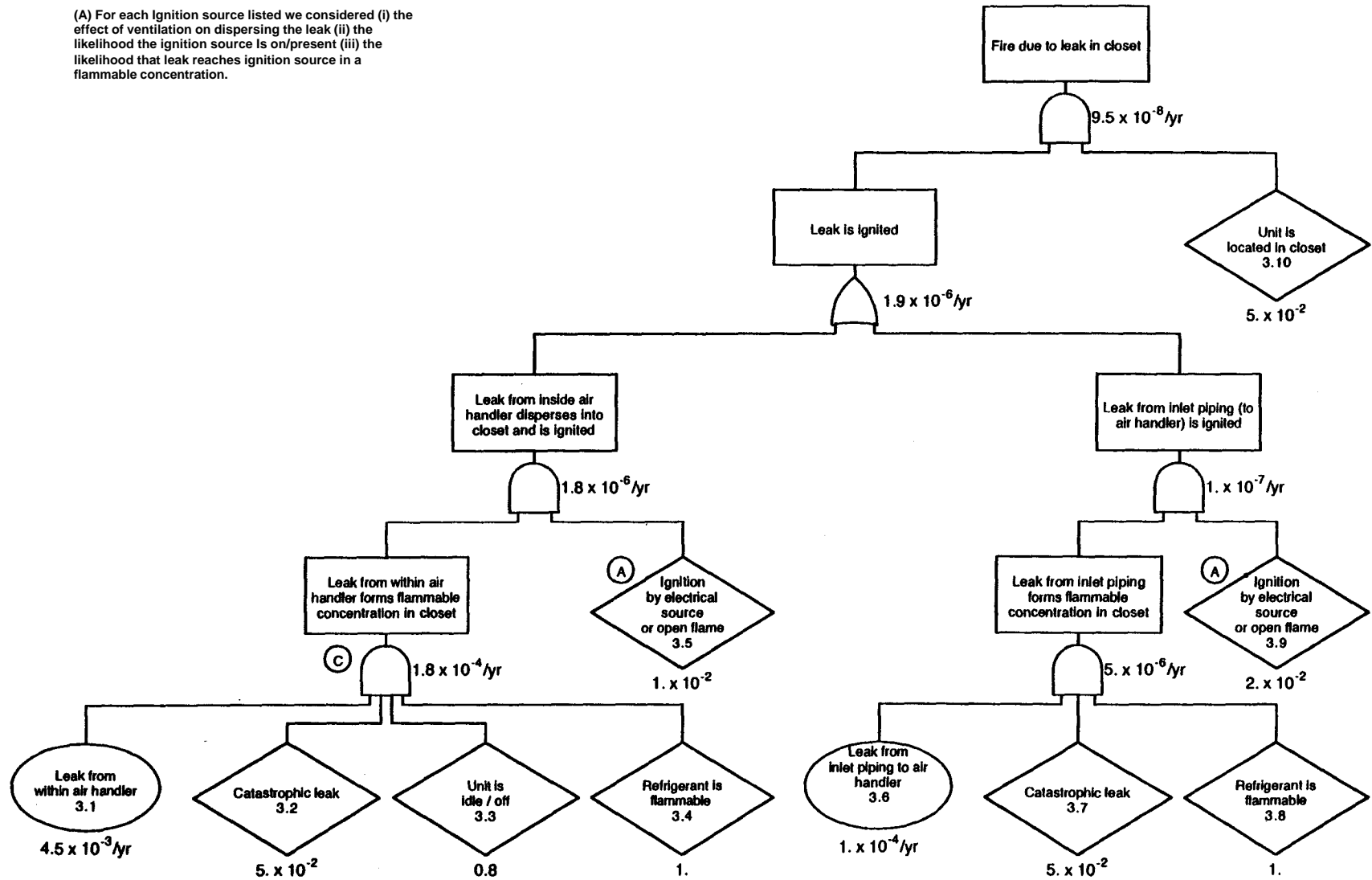

List (i): Possible electrical Ignition sources in closet:

- oil furnace sparker ignitor
- broken light bulb
- high voltage electrical spark

List (ii): Possible open flame ignition sources in closet:

- flame (water heater, furnace)
- pilot light (water heater, furnace)

4. Fire within air handler (Rev1)

(A) We assume the unit cycles between on and idle mode every 15 minutes. Assume that if a leak occurs during the idle period, the leak is at a flammable concentration when the unit cycles on again, for a brief moment.

(B) Testing has shown that if the air handler is confined within a closet, a sustained flammable concentration can be achieved within the air handler. However, for air handlers installed in a less confined area e.g. basement/attic, a flammable concentration is achieved only momentarily in some parts of the air handler. The risks are therefore much lower than in a closet installation.

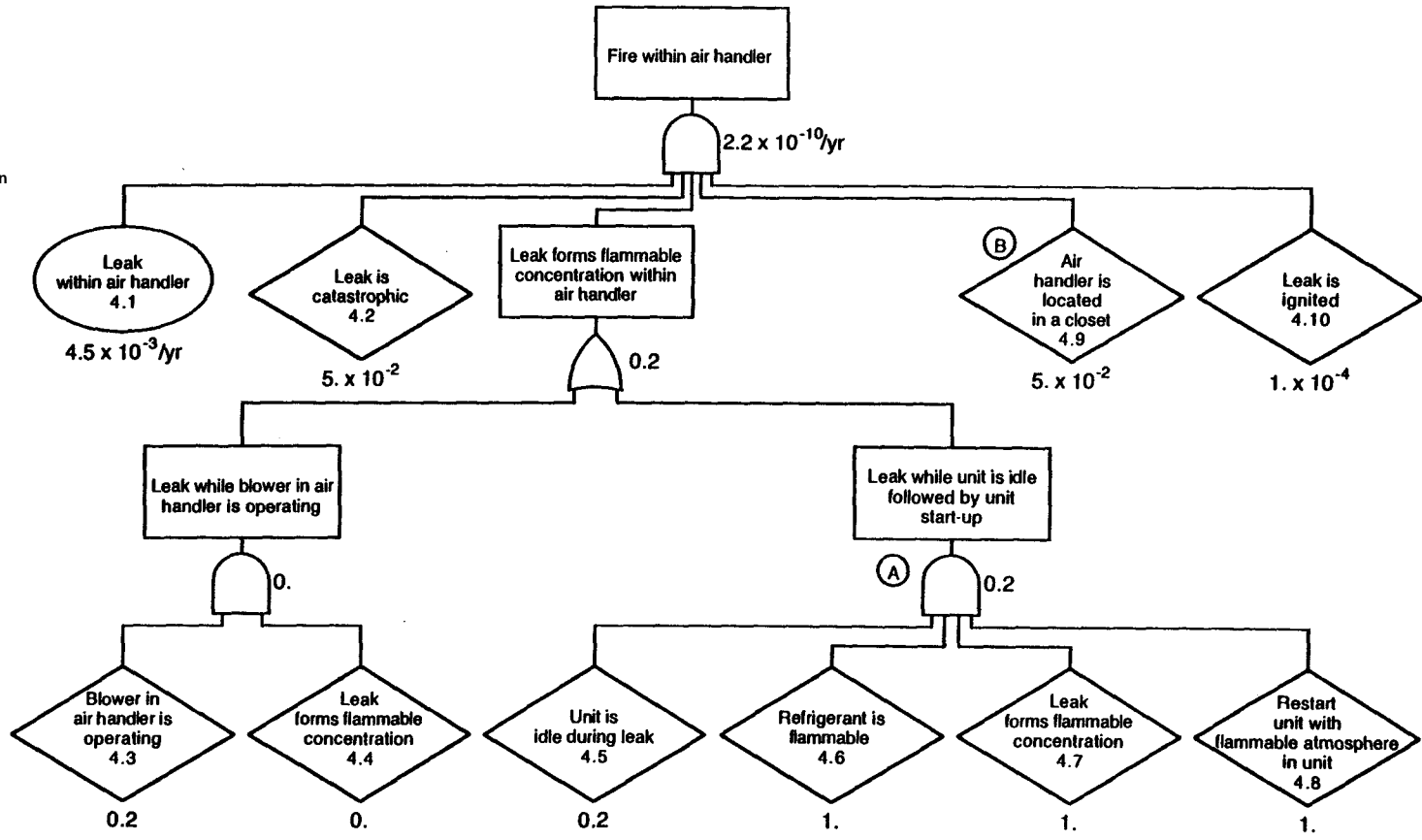

List of potential ignition sources within air handler:

- high voltage electric spark
- supplemental heater element is white hot (fault condition)

5. Fire in room due to leak into duct (Rev1)

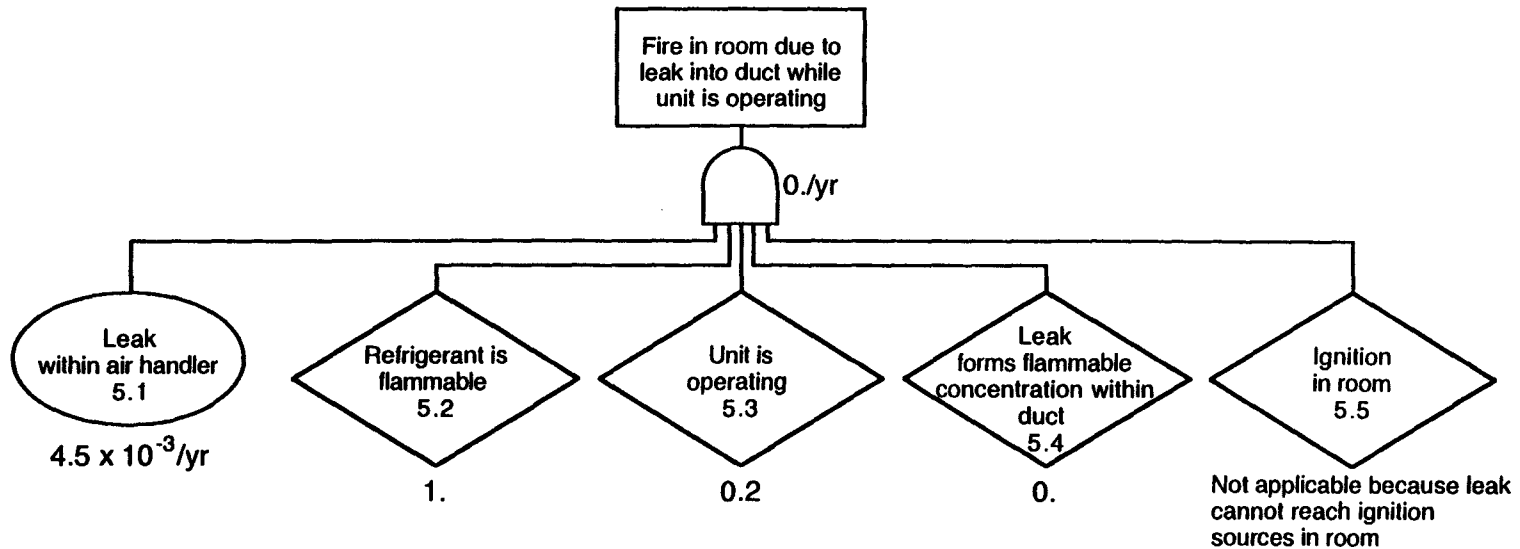

Potential ignition sources in kitchen:

- match/lighter
- gas flame (cooker, water heater, clothes dryer)
- gas pilot (water heater, clothes dryer)
- portable fuel heater
- high voltage electric spark (loose wires)
- electric cooker
- electric resistance heater
- broken light bulb

Potential ignition sources in bedroom:

- match/lighter
- portable fuel heater
- high voltage electric spark (loose wires)
- electric resistance heater
- broken light bulb
- hairdryer or curling iron

Potential ignition sources in living/dining room:

- match/lighter
- portable fuel heater
- gas fire
- wood/pellet stove
- high voltage electric spark (loose wires)
- electric resistance heater
- broken light bulb

6. Fire during servicing (Rev1)

(A) Procedures involving venting or charging apply to the outdoor condensing unit only.

(B) We consider only the chance of ignition by a match/lighter used by the service engineer in close proximity to the unit. Ignition by other sources is unlikely since experimental testing has shown that a leak is rapidly dispersed outdoors.

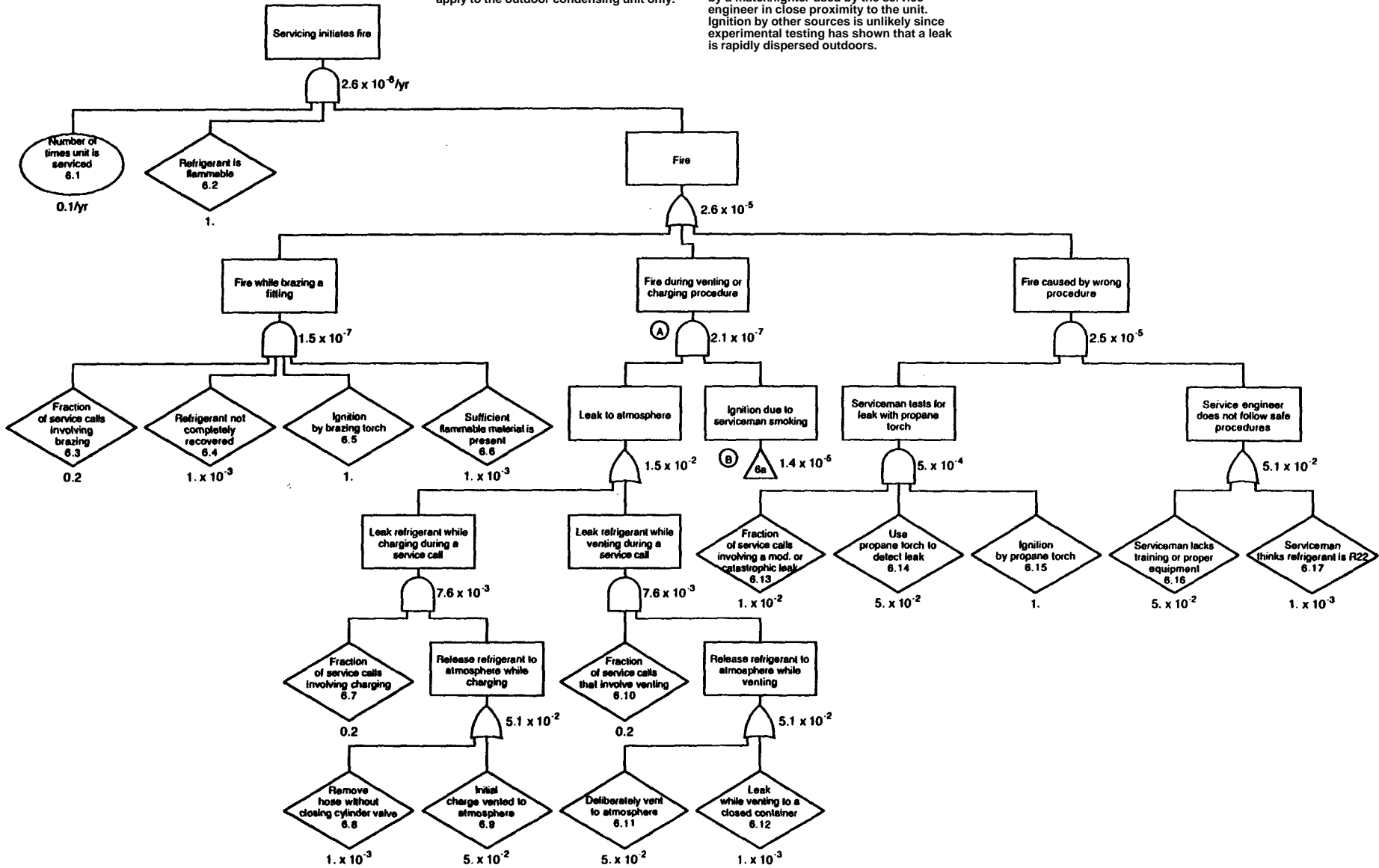

6a. Ignition due to serviceman smoking

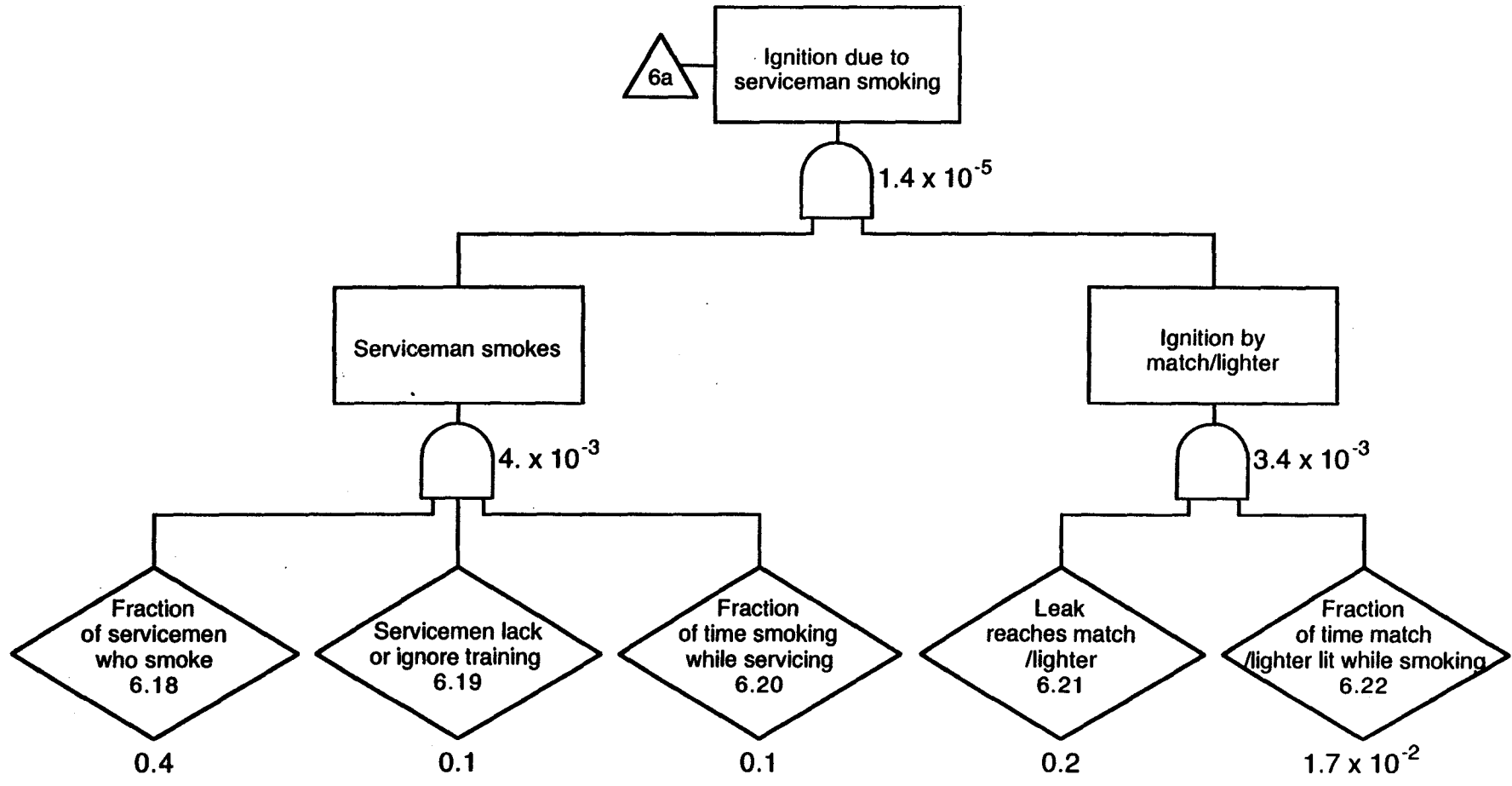

7. Fire due to leak in wall void (Rev1)

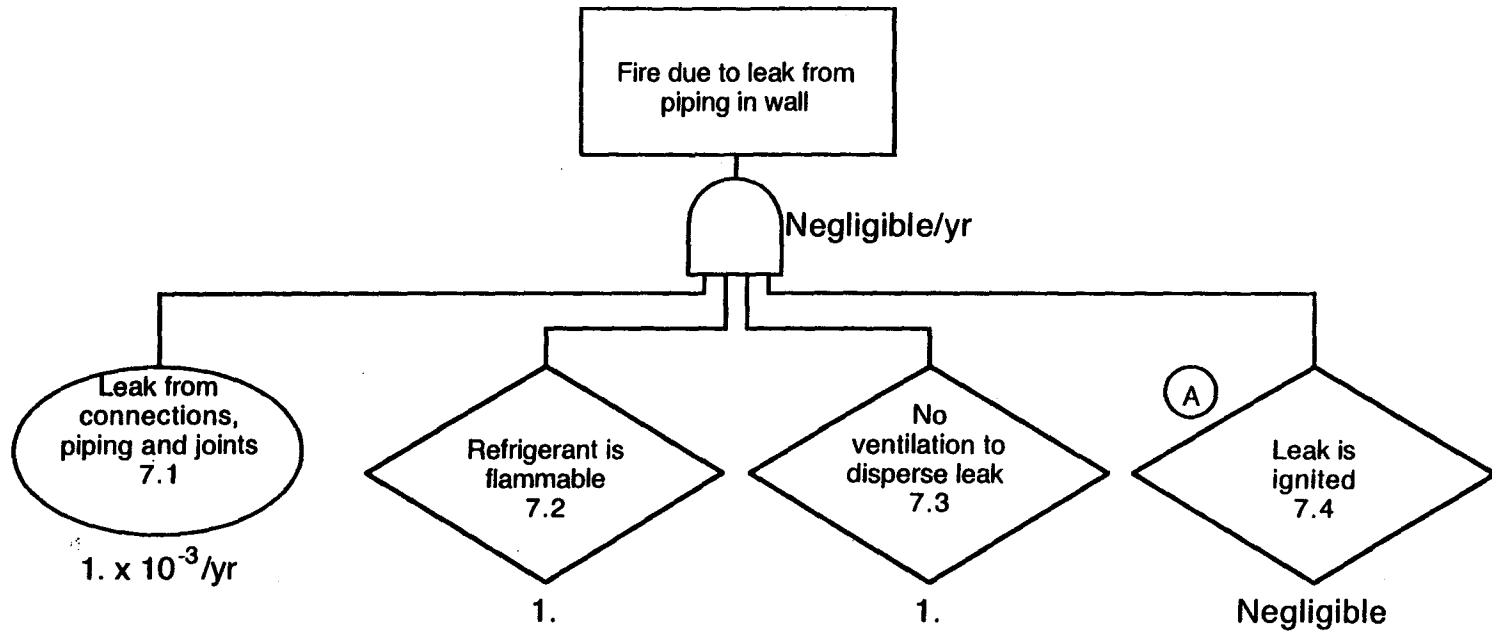

(A) Potential ignition source is a high voltage spark generated by loose wires; however this is not considered feasible in a domestic installation.

8. Fire due to leak from outdoor condensing unit (Rev1)

(A) Only catastrophic leaks have been considered since slow leaks are unlikely to form a flammable concentration within the unit.

(B) Ignition external to the condensing unit is not considered because test results show a leak outdoors is rapidly dispersed to below flammable concentrations.

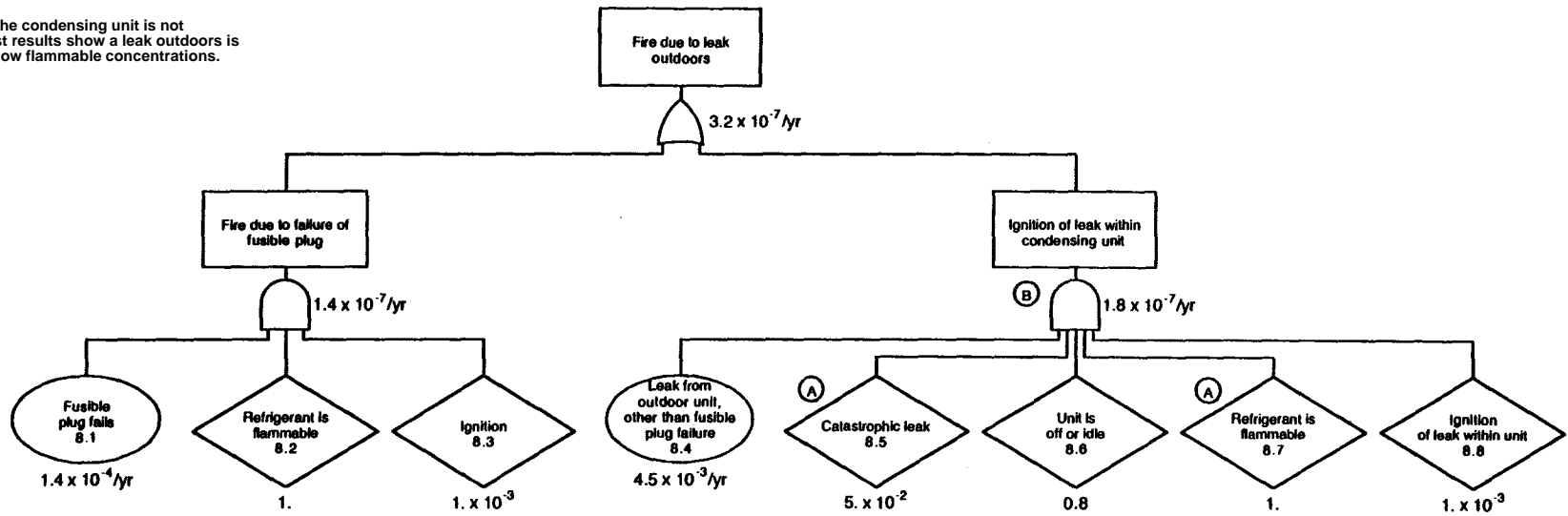

Potential ignition sources within condensing unit:

- high voltage electric spark (e.g. faulty wiring)
- compressor contactor (at locked rotor condition)

9. Fire in room providing return air (Rev1)

(A) Return air is generally taken from a hallway, although less commonly may be taken from a number of rooms.

Potential ignition sources within hallway:

- match/lighter
- broken light bulb
- high voltage electric spark
- candle

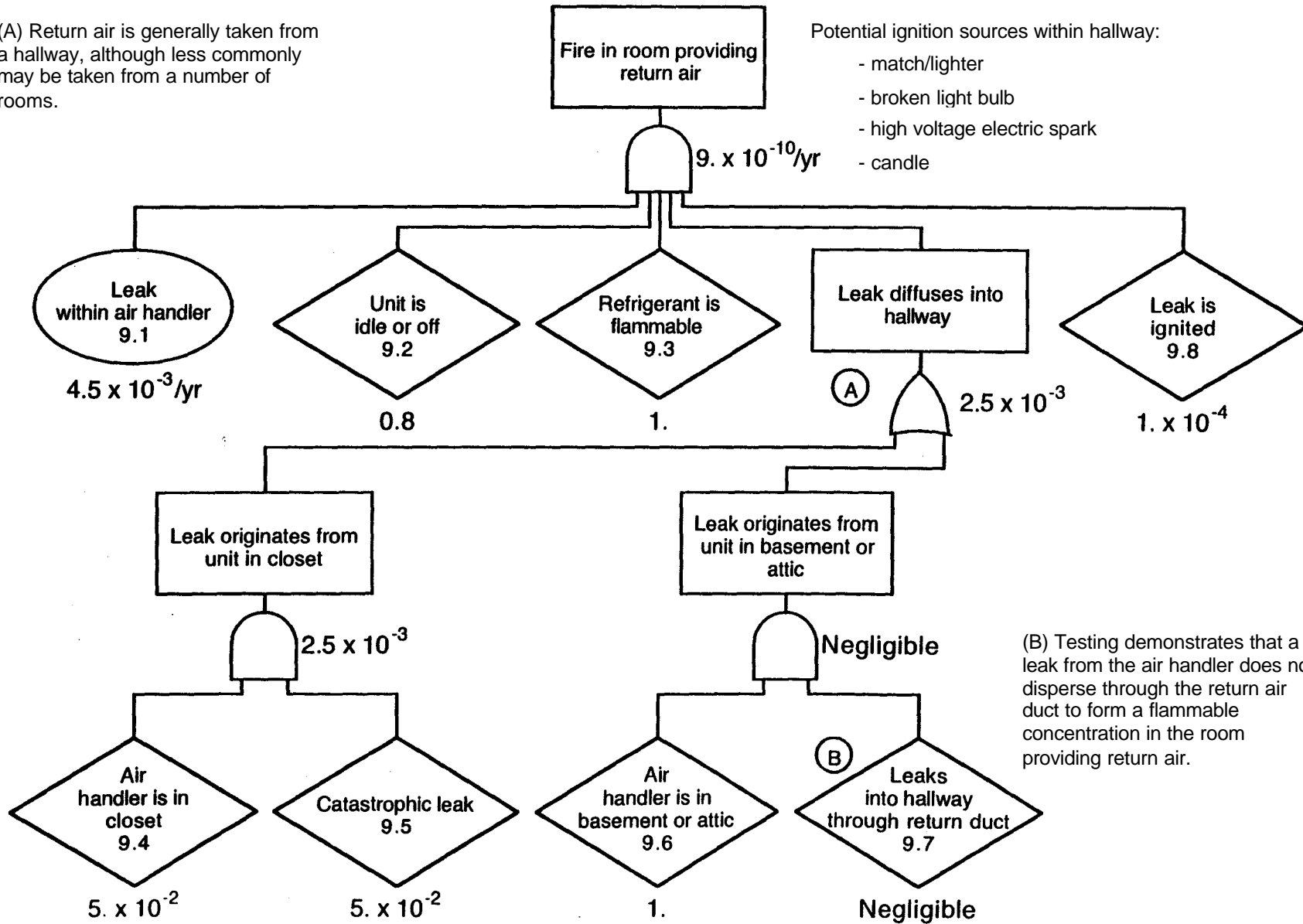

13. Appendix D: Fault Tree Rationale

Rationale for Fault Trees (Baseline Unit in Located in Northeastern US)

	Event	Probability or Frequency	Source/Discussion
1.1	Leak from within air handler	4.5×10^{-3} /yr	An analysis of leak rate data from a number of industry bodies and organizations contacted by Arthur D. Little suggests a conservative leak rate for a split system heat pump is 0.01/unit/yr. The data also shows that approximately equal number of leaks occur in the condensing unit and the air handler. Assuming that 10% of leaks occur from piping between the two units, the remaining 90% of leaks are split equally between the air handler and condensing unit. This yields a leak frequency of 4.5×10^{-3} /yr for the air handler.
1.2	Catastrophic leak	5×10^{-2}	Concentration mapping results by FMRC demonstrate that only catastrophic leaks within the air handler form flammable concentrations outside the air handler when the blower is off. Historical data shows that, at most, 5% of leaks are catastrophic.
1.3	Unit is idle or off	0.8	Concentration mapping results demonstrated that only when the unit is off or idle can a leak form a flammable concentration outside the air handler. When the blower is on, the leak is rapidly dispersed to below flammable concentrations. Analysis of heating and cooling usage hours for the Northeast US from the 'ARI directory of Certified Unitary Equipment' suggests the unit is off 60% of time. We assume the unit is on but idle for a further 20% of time.
1.4	Refrigerant is flammable	1	HFC-32 is flammable 100% of the time and we assume the blend is also flammable 100% of the time. This is conservative since only compositions rich in HFC-32 will be flammable. There is some debate over the exact composition at which the blend is flammable, but some sources suggest it is as low as 40/60% HFC-32/134a. At room temperatures of 20°C a 30:70% liquid blend has a vapor composition greater than 40/60 HFC-32/134a.

	Event	Probability or Frequency	Source/Discussion
1.5	Ignition by electrical source or open flame (in basement/garage)	5×10^{-4}	The most probable ignition sources would be pilot flames; for example, on a gas water heater, a furnace, or possibly an old gas fired clothes dryer. An analysis of how often ignition sources are on/present and how likely the leak reaches these ignition sources gives a probability of 5×10^{-3} . However, ignition testing by FMRC demonstrated that pilot flames are unlikely to ignite a leak in an open room; we have therefore reduced the probability to 5×10^{-4} . Ignition by a electrical source is significantly less likely because few sources are strong enough to ignite HFC-32, as shown in the UL testing.
1.6	Leak from inlet piping to air handler	1×10^{-4} /yr	Since the section of inlet piping to the air handler is short, we assume only a small percentage (<1%) of historical leaks (0.01/yr) occur from the inlet piping, yielding a leak rate of 1×10^{-4} /yr.
1.7	Catastrophic leak	0.05	Concentration mapping results by FMRC demonstrate that a fast leak (around 100 g/min) into a quiescent room forms a flammable concentration. Historical data suggests that roughly 5% of leaks are catastrophic in nature.
1.8	Refrigerant is flammable	1	See 1.4
1.9	Ignition by electrical source or open flame	3×10^{-3}	Concentration mapping results demonstrated that a direct leak into a room results in a more extensive flammable cloud than a leak from within the air handler. Since more ignition sources may be encountered we estimate a higher probability of ignition for a leak from the inlet piping than from within the air handler (See 1.5).
1.10	Unit is located in basement /garage	0.85	We assume 85% of air handlers are located in the basement/garage in the Northeast US, based on interviews with air conditioner suppliers and installers.

	Event	Probability or Frequency	Source/Discussion
2.1	Leak from within air handler	4.5×10^{-3} /yr	See 1.1
2.2	Catastrophic leak	0.05	See 1.2
2.3	Unit is idle/off	0.8	See 1.3
2.4	Refrigerant is flammable	1	See 1.4
2.5	Ignition by electrical source or open flame	4×10^{-4}	The most probable ignition sources would be pilot flames; for example, on a gas water heater. An analysis of how often ignition sources are on/present and how likely the leak would reach these ignition sources gives an ignition probability of 4×10^{-3} . However, ignition testing by FMRC demonstrated that pilot flames are unlikely to ignite a leak in an open room; we have therefore reduced the probability to 4×10^{-4} . Ignition by an electrical source is considered negligible. Testing by UL demonstrated that a high voltage spark is required for ignition, and this is not found inside living spaces.
2.6	Leak from inlet piping to air handler	1×10^{-4} /yr	See 1.6
2.7	Catastrophic leak	0.05	See 1.7
2.8	Refrigerant is flammable	1	See 1.4
2.9	Ignition by electrical source or open flame	2×10^{-3}	Concentration mapping results demonstrated that a direct leak into a room results in a more extensive flammable cloud than a leak from within the air handler. Since more ignition sources may be encountered, we estimate a higher probability of ignition for a leak from the inlet piping than from within the air handler (See 2.5).
2.10	Unit is located in attic	0.10	We assume 10% of air handlers are located in an attic in the Northeast, based on interviews with air conditioner suppliers and installers.

	Event	Probability or Frequency	Source/Discussion
3.1	Leak from within air handler	4.5×10^{-3} /yr	See 1.1
3.2	Catastrophic leak	0.05	See 1.2
3.3	Unit is idle/off	0.8	See 1.3
3.4	Refrigerant is flammable	1	See 1.4
3.5	Ignition by electrical source or open flame	1×10^{-2}	The most probable ignition sources would be pilot flames; for example, on a gas water heater, or a furnace. An analysis of how likely ignition sources are on/present and how likely the leak reaches the ignition source gives an ignition probability of 1×10^{-1} . However, ignition testing by FMRC demonstrated that pilots in a closet briefly ignite before being extinguished; we have therefore reduced the probability to 1×10^{-2} . Ignition by an electrical source is significantly less likely because the potential sources of ignition occur rarely.
3.6	Leak from inlet piping to air handler	1×10^{-4} /yr	See 1.6
3.7	Catastrophic leak	0.05	See 1.2
3.8	Refrigerant is flammable	1	See 1.8
3.9	Ignition by electrical source or open flame	2×10^{-2}	A direct leak into a closet from the inlet piping is likely to result in a flammable cloud which extends further into the closet than a leak from within the air handler. We therefore assume the ignition probability of a leak from the inlet piping is twice as likely as from within the air handler (See 3.4).
3.10	Unit is located in closet	0.05	We assume 5% of air handlers are located in a closet in the Northeast, based on interviews with air conditioner suppliers and installers.

	Event	Probability or Frequency	Source/Discussion
4.1	Leak within air handler	4.5×10^{-3} /yr	See 1.1
4.2	Leak is catastrophic	0.05	Testing by FMRC demonstrated that only catastrophic leaks resulted in flammable concentrations within the air handler. Historical data suggests that about 5% of leaks are catastrophic.
4.3	Blower in air handler is operating	0.2	Analysis of heating and cooling usage hours for the Northeast from the 'ARI Directory of Certified Unitary Equipment' suggests the unit is off 60% of time. For the remaining 40% of the time the unit is switched on, we assume the unit is idle for half the time, and the blower therefore operates 20% of year.
4.4	Leak forms flammable concentration within air handler	0	Experimental tests demonstrate that a flammable concentration is never achieved while the unit is operating because the blower enhances refrigerant dispersion.
4.5	Unit is idle during leak	0.2	See 4.3
4.6	Refrigerant is flammable	1	See 1.4
4.7	Leaks forms flammable concentration	1	Experimental tests show that a flammable concentration can occur within the unit if installed in a highly confined environment; for example in a closet. (See 4.9)
4.8	Restart unit with a flammable atmosphere.	1	We assume the unit cycles between operational and idle modes every 15 minutes while switched on. Testing by FMRC demonstrated that a flammable concentration exists for several minutes when the leak is catastrophic. We conservatively assume, that for all catastrophic leaks, a flammable atmosphere persists in the unit until it cycles on again.

	Event	Probability or Frequency	Source/Discussion
4.9	Air handler is located in a closet	0.05	Testing by FMRC demonstrated that if the air handler is confined within a closet, a sustained flammable concentration can be achieved within the air handler. However for air handlers installed in a less confined area, e.g., a basement/garage, a flammable concentration is achieved only momentarily.
4.10	Leak is ignited	1×10^{-4}	Potential ignition sources within the air handler include a white hot heater element (two point failure condition), or a high voltage electric spark. If a leak occurs in the air handler it is highly probable that these ignition sources, if active, will be encountered by the leak. However the occurrence of either of these ignition sources is rare and we therefore assume one chance in ten thousand that ignition occurs.
5.1	Leak within air handler	4.5×10^{-3} /yr	See 1.1
5.2	Refrigerant is flammable	1	See 1.4
5.3	Unit is operating	0.2	Only when the blower operates can refrigerant be blown into the ductwork and penetrate rooms supplied by the air conditioning system (See 4.3).
5.4	Leak forms flammable concentration in duct and room	0	Tests performed by FMRC demonstrate that a flammable concentration is never achieved in the duct when the blower operates. Thus a leak of refrigerant does not form a flammable concentration within a room or air conditioning ductwork.
5.5	Ignition within room	Not applicable	This leaf is not applicable because testing demonstrated that a flammable concentration of refrigerant cannot be formed within the room.

	Event	Probability or Frequency	Source/Discussion
6.1	Number of times unit is serviced	0.1 /yr	Based on ADL proprietary data, approximately 10% of units are serviced in the first year of warranty.
6.2	Refrigerant is flammable	1	See 1.4
6.3	Fraction of service calls involving brazing	0.15	Estimate based on ADL proprietary data.
6.4	Refrigerant not completely recovered	1×10^{-3}	Servicemen are trained to reduce the pressure in the system prior to brazing for safety reasons. It is highly unlikely that the servicemen will braise without reducing the system pressure. A human error rate of 1×10^{-3} is used.
6.5	Ignition by brazing torch	1	The brazing torch is both the cause of the release and the ignition source. The ignition source will always be present by definition of the scenario, and the brazing torch has sufficient energy to cause ignition.
6.6	Sufficient flammable material is present	1×10^{-3}	In general the amount of flammable vapor released will be very small. Only under particular circumstances, or if there are other flammable materials nearby which ignite, is there any significant hazard.
6.7	Fraction of service calls that involve charging system with refrigerant	0.15	Charging is required for all calls relating to leaks or where deliberate venting is required for repair. Based on ADL proprietary data 5% of calls relate to repairs to the refrigerant loop, and 10% relate to leaks. This gives a total of 15 % of service calls that require charging.

	Event	Probability or Frequency	Source/Discussion
6.8	Remove hose without closing cylinder valve	1×10^{-3}	Servicemen are trained how to charge system with refrigerant properly and safely. It is highly unlikely the servicemen will remove the hose without closing the cylinder valve first. A human error rate of 1×10^{-3} is used.
6.9	Initial charge vented to atmosphere	0.05	With units using non-flammable refrigerants, air may be flushed from the system by venting the first charge of refrigerant to atmosphere with the pressure switches open. Assuming this activity is discouraged through training and regulations, we assume a probability of 0.05.
6.10	Fraction of service calls that involve venting	0.15	Charging is required for all calls relating to leaks or where deliberate venting is required for repair. Based on ADL proprietary data 5% of calls relate to repairs to the refrigerant loop, and 10% relate to leaks. We conservatively assume that the leak has not finished discharging when the service contractor arrives and therefore the system must be vented before starting repair work. This gives a total of 15% of service calls that involve venting.
6.11	Deliberately vent to atmosphere	0.05	Though deliberate venting of refrigerants to atmosphere is currently prohibited, there is a chance these regulations will be ignored. Assuming this activity is discouraged through training and regulations, we assume a likelihood of 0.05 (See 6.9).
6.12	Leak while venting to a closed container	1×10^{-3}	If the container and refrigerant circuit are not connected properly, for example, through a loose fitting, refrigerant could be released. Since the service engineer is trained in this activity, we assigned a probability of human error of 1×10^{-3} .

	Event	Probability or Frequency	Source/Discussion
6.13	Fraction of service calls that involve a moderate or catastrophic leak	1×10^{-2}	Based on warranty service data from heat pump manufacturers, 5% of service calls relate to leaks. Based on Arthur D. Little proprietary data we assume that 20% of these leaks are moderate or catastrophic.
6.14	Use propane torch to detect leak	0.05	Based on discussions with heat pump manufacturers and service representatives, we estimate that a propane torch could be used to detect leaks less than 5% of the time. Use of a propane torch is an old technique superseded by more advanced techniques e.g., electronic detectors. In addition, a propane torch can only detect a leak of refrigerant which contains chlorine, so it will become obsolete in the future.
6.15	Ignition by propane torch	1	The propane torch will always be present by definition of this scenario, and has sufficient energy to cause ignition if it encounters the leak.
6.16	Serviceman lacks training or proper equipment	0.05	We assume a 2.5% chance that a service engineer is not trained in safe leak detection practice. Those from large operations should have adequate training; however, smaller operators may not conduct thorough training and are far beyond the control of the manufacturer. We assume an additional 2.5% chance that the service engineer ignores training because of the cost of buying expensive leak detection equipment. This gives an overall probability of 5%.
6.17	Service engineer thinks refrigerant is R22	1×10^{-3}	Serviceman could think the system contains HCFC- 22 if the warning label is removed, is visually obscured, or if he makes a mistake and forgets to check. Assign CONCAWE probability for human error of 1×10^{-3} .
6.18	Fraction of servicemen who smoke	0.4	About 25-30% of the US population smokes; since young children do not smoke, we assume 40% of servicemen smoke.

	Event	Probability or Frequency	Source/Discussion
6.19	Servicemen lack or ignore training	0.1	Servicemen are instructed not to smoke during servicing. However, there is no real reinforcement of this instruction. We estimate that over time 10% will ignore the instruction, particularly since they are used to dealing with non-flammable refrigerants.
6.20	Fraction of time smoking while servicing	0.1	We estimate a serviceman spends a maximum of 10% of time smoking while servicing the unit.
6.21	Leak reaches match / lighter	0.2	We assume a 20% chance that the match /lighter is within the flammable zone. The serviceman will spend most of his time in close proximity to the unit, but if a leak occurs it will tend to slump downwards.
6.22	Fraction of time match / lighter lit while smoking	0.017	We assume a match/lighter is lit for 5 seconds and a cigarette takes 5 minutes to smoke.
7.1	Leak from connections, piping and joints	1×10^{-3} /yr	We assume 10% of the overall rate for historical leaks (0.01/unit/yr) occur from piping in the wall (See 1.1)
7.2	Refrigerant is flammable	1	See 1.4
7.3	No ventilation to disperse leak	1	We assume there is no ventilation in the wall to disperse the leak.
7.4	Leak is ignited	Negligible	A potential ignition source is a spark generated by faulty wiring. Tests performed by UL showed that HFC-32 is only ignited by a very high voltage spark. It is unlikely that such a high voltage spark could be present in or near living spaces.
8.1	Fusible plug fails	1.4×10^{-4} /yr	Based on ADL proprietary data, the fusible plug on the compressor fails, causing a catastrophic refrigerant release with a frequency of 1.4×10^{-4} /yr.

	Event	Probability or Frequency	Source/Discussion
8.2	Refrigerant is flammable	1	See 1.4
8.3	Ignition of leak following fusible plug failure	1×10^{-3}	Based on ADL proprietary data, all fusible plug failures have resulted in ignition of the lubricant. Ignition tests by UL demonstrated that only high energy ignition sources cause ignition of HFC-32 or the blend. We assume a probability of ignition of 1 in 1000.
8.4	Leak from outdoor unit, other than fusible plug failure	4.5×10^{-3} /yr	A number of ADL proprietary sources suggest a leak rate of 0.01/unit/yr; we assume 45% of leaks originate within the outdoor condensing unit (See 1.1)
8.5	Catastrophic leak	0.05	Based on ADL proprietary test information, only catastrophic leaks are likely to form a flammable concentration within the condensing unit. Historical data shows that approximately 5% of leaks are catastrophic.
8.6	Unit is off or idle	0.8	A flammable concentration is unlikely to form when the unit is operational because the fan will enhance dispersion. However a flammable concentration can form when the unit is off or idle. (See 1.3)
8.7	Refrigerant is flammable	1	See 1.4
8.8	Leak ignited within condensing unit	1×10^{-3}	The most likely ignition source within the condensing unit is the compressor contactor at locked rotor condition. This occurs for a very short time every time the compressor cycles on. Since ignition depends on both unit activity level and duration of the flammable concentration, we assume a chance of ignition of 1 in 1000, which is 10 times more likely than in the air handler.
9.1	Leak within air handler	4.5×10^{-3} /yr	See 1.1
9.2	Unit is off or idle	0.8	The unit must be off or idle for a leak to disperse into the room providing return air. (See 1.3)

	Event	Probability or Frequency	Source/Discussion
9.3	Refrigerant is flammable when unit is idle or off	1	See 1.4
9.4	Air handler is in closet	0.05	See 3.10
9.5	Catastrophic leak	0.05	Experimental testing by FMRC showed that a catastrophic leak from an air handler within a closet forms a flammable concentration outside of the closet.
9.6	Air handler is in attic or basement/garage	0.95	See 1.10 and 2.10
9.7	Refrigerant leaks into hallway through return duct	Negligible	Experimental testing by FMRC showed that a refrigerant leak from within the air handler does not form a flammable concentration within the return air duct.
9.8	Leak is ignited	1×10^{-4}	Potential ignition sources include a match/lighter, a broken light bulb, a high voltage electric spark, or a candle. We considered how likely a leak is to encounter each of these sources, and how often these ignition sources are on/present. We estimate an ignition probability of 1 in 10,000.