

The Impact of Duct Design on Life Cycle Costs of Central Residential Heating and Air-conditioning Systems

AHRI Project No. 8002 Final Report

Prepared for:
Air Conditioning, Heating, and Refrigeration Institute
2111 Wilson Blvd., Suite 500
Arlington, VA 22201

April 2014

Prepared by:
Dr. Brent Stephens (PI)
Department of Civil, Architectural and Environmental Engineering
Illinois Institute of Technology
Chicago, IL USA

Table of contents

Executive Summary	ES-1
Introduction.....	1
Direct and indirect energy impacts of excess pressure.....	1
PSC blowers.....	2
ECM/BPM blowers.....	3
Methodology.....	4
Task 1. Identify house plans in two climates	5
Task 2. Estimate installation costs of ductwork	7
Task 3. Translate ductwork designs to energy modeling software and estimate impacts of system pressures on power draw, airflow, and system capacity	8
Subtask 3.1: Identifying representative airflow, pressure, and power data for AHU fans ..	9
Subtask 3.2: Identifying likely changes in system capacities based on airflow responses	14
Subtask 3.3: Estimating ductwork surface areas.....	16
Task 4. Estimate annual operating energy use for each scenario	21
Energy modeling procedures	21
Task 5. Life cycle cost estimation and optimization	23
Task 6. Sensitivity analysis	25
Results.....	26
Initial costs of duct designs	26
Annual energy simulation results	28
Chicago Home: Chicago contractor designs.....	28
Austin Home: Chicago contractor designs	32
Chicago Home: Austin contractor designs	38
Austin Home: Austin contractor designs	41
Life cycle cost-benefit analysis	49
Lifetime (15-year) HVAC energy savings: All pressure, fan, and duct material scenarios	50
NPV analysis assuming 15-year life cycle: Flex duct only	53
NPV analysis assuming 15-year life cycle: Rigid ducts only	56
NPV analysis assuming 15-year life cycle: Comparing both flex and rigid duct scenarios	59
Optimization and sensitivity based on the simulation results	62
Sensitivity analysis	64
Limitations.....	68
Conclusions.....	69
Acknowledgements.....	69
References.....	70
Appendix: Duct designs from contractors	73

Executive Summary

Many central residential heating and air-conditioning systems in the U.S. have substantially higher external static pressures than recommended by standards and ratings organizations, often due to undersized and constricted ductwork. Because excess external static pressures can have negative impacts on energy consumption, lower resistance ductwork designs (which may be achieved by a combination of lower resistance materials, larger ductwork diameter, and proper field installation) are typically considered best practices within the industry. However, the impacts of high external static pressures on energy consumption are complex, as the relationships between pressure, fan efficiency, fan power draw, airflow rates, heating and cooling capacities and efficiencies, and system runtimes are also complex and depend in part on the type of blower motor used in the air handling unit (AHU). Moreover, there is a lack of information on optimal operational static pressures for central residential heating and air-conditioning systems and, importantly, the overall life cycle energy and cost impacts of utilizing lower pressure duct designs compared to higher pressure designs.

Therefore, in this work we have performed whole building energy simulations and a life cycle cost analysis to compare the total life cycle costs of centralized space conditioning in two new single-family model homes in two separate climates in the United States (Austin, TX and Chicago, IL), both operating under a range of assumptions for operating external static pressures and with real ductwork design configurations as determined by local HVAC contractors. Energy simulations followed a framework of scenarios with specified assumptions for low, medium, and high external static pressures paired with blowers utilizing both permanent split capacitor (PSC) motors and electronically commutated motors (ECMs) in each modeled home. Local heating and air-conditioning contractors in each location provided actual duct designs and cost estimates for both flexible and rigid sheet metal ductwork materials to meet each specified pressure in each home. These designs varied in upfront costs (due to design details, material costs, and labor costs), material type (flexible duct and rigid sheet metal), and ductwork lengths, diameter, and overall layout (and therefore surface areas of ductwork installed in unconditioned space) in order to achieve the predetermined levels of static pressure. Each duct design was assumed to be correctly installed according to standard industry practices (e.g., with minimal compression or sag). The contractors provided their design and installation cost estimates as if the duct systems were to actually be designed and installed in each home. The predetermined external static pressure values were used to estimate the impacts on airflow rates, fan power draws, fan efficiencies, and overall heating and cooling capacities in each scenario using existing fan curve and system performance data for nationally representative residential PSC and ECM blowers, which were then combined with ductwork characteristics from the contractors (e.g., duct UA values) to simulate annual energy consumption for each ductwork design and static pressure level in each home using EnergyPlus.

The Chicago home had a floor area of 2100 ft² and utilized a 15 SEER 3-ton central air-conditioning unit with a 92.5% AFUE 68 kBTU/hr gas-fired furnace with a nominal airflow rate of 1200 CFM at the lowest system pressure of 0.50" w.c. (125 Pa). The Austin home had a floor area of 3150 ft² and utilized a 15 SEER, 8.5 HSPF 4-ton air-source heat pump with a nominal airflow rate of 1600 CFM at the lowest system pressure of 0.55" w.c. (138 Pa). The Chicago home had ducts installed in an unconditioned basement and the Austin home had ducts installed

in an unconditioned attic. Each home was modeled at three static pressure conditions with both PSC and ECM blowers and with both flexible and rigid sheet metal ductwork designs specified to achieve each static pressure level. Low, medium, and high pressures for the Chicago home were 0.50" w.c. (125 Pa), 0.80" w.c. (200 Pa), and 1.10" w.c. (275 Pa), respectively; the same pressure levels were 0.55" w.c. (138 Pa), 0.85" w.c. (213 Pa), and 1.15" w.c. (288 Pa) in the larger Austin home. In general, lower pressure duct designs were assumed to increase airflow rates and fan power draws in systems with PSC blowers, which was expected to primarily decrease system runtimes and reduce overall energy consumption. Lower pressure duct designs with ECM blowers were assumed to decrease fan power draws while keeping airflow rates nearly constant, which was expected to primarily decrease fan energy consumption, all else being equal. However, differences in contractor duct designs (which primarily affected duct UA values) complicated these expected results somewhat because of heat transfer across ductwork in unconditioned spaces.

Overall, these combinations provided a total of 48 annual building energy simulations, results of which were used to compare the expected annual heating and air-conditioning energy costs between each duct design and system configuration over an assumed 15-year lifespan for each home. Finally, these 15-year life cycle energy cost differences were used alongside the contractor cost estimates for each duct design to compare differences in total life cycle costs of each scenario in terms of net present values (NPVs) using standardized industry assumptions for discount rates, cost of inflation, and future electricity and gas prices.

Summary of Results

Key sections of the full report are summarized below.

AHU performance characteristics

We relied on virtual models of dozens of fan manufacturers to summarize the likely airflow rate and fan power draw responses to the external static pressures specified herein. For both PSC and ECM blowers, nominal airflow rates of 1200 CFM and 1600 CFM were assumed in the Chicago and Austin homes at the lowest external static pressures of 0.50" w.c. and 0.55" w.c., respectively. Increases in external static pressure to 0.80" w.c. (Chicago medium) or 0.85" w.c. (Austin medium) were expected to yield 20% and 18% reductions in flow for the PSC blowers and 3% and 1% reductions in flow for ECM blowers, respectively. Similarly, increases in external static pressure to 1.10" w.c. (Chicago high) and 1.15" w.c. (Austin high) were expected to yield 48% and 43% reductions in flow for PSC blowers and 8% and 2% reductions in flow for ECM blowers, relative to the lowest pressure cases. For the Chicago home, these flow changes corresponded to as much as a 41% reduction in fan power draw (PSC) and as much as a 42% increase in fan power draw (ECM) at the highest pressure. Similarly for the Austin home, the highest pressure yielded a 36% decrease in fan power draw for the PSC blower and a 55% increase in fan power draw for the ECM blower. These pressure, flow, and power draw changes are generally consistent not only with manufacturer data but with data from both laboratory and field tests. Changes in heating and cooling capacities and efficiencies at each of these airflow rates were then captured using built-in polynomial functions in EnergyPlus and used to predict annual space conditioning energy requirements in each scenario. Overall, these AHU characteristics represent values under rather extreme changes in external static pressures, which serve to provide an estimate of the likely bounds of energy impacts involved. In reality,

contractors may simply increase the fan size or change fan speed settings to overcome excess pressure in the field, but these simulations do not explore that possibility.

Costs and characteristics of duct designs

For both the Austin and Chicago home duct designs by the Chicago contractor, lower pressure ducts were more expensive than higher pressure ducts, with costs of the lowest pressure designs ranging from 3% to 26% higher than the highest pressure designs, depending on home, target pressure, and material selection. These cost differences largely stemmed from using larger diameter duct materials to achieve lower target pressures. Cost differences in the Austin contractor's designs were smaller and not as straightforward, with some lower pressure designs even being slightly less expensive than higher pressure designs (although the magnitude of differences were also smaller). These differences are attributed in part to very different designs between the two contractors to meet the same goals. For example, designs by the Chicago contractor resulted in duct surface areas that were typically 20-40% higher than the Austin contractor's designs for a given target pressure, reflecting large differences in material use efficiencies. The Chicago contractor typically used a radial flex duct design where each supply register was served by an individual branch beginning at the AHU, while the Austin contractor typically used more material-efficient trunk and branch designs. These differences yielded substantial differences in duct UA values (assuming R-6 ductwork insulation for all scenarios), which are important to capture to account for heat transfer across ducts installed in unconditioned space. Finally, there were also large differences in costs for rigid sheet metal ducts compared to flexible duct designs according to both contractors. Rigid duct designs were estimated to cost as much as ~\$6000 more than flex duct designs for some configurations, which had a large impact on the life cycle cost estimates herein.

Annual energy simulation results

Lower airflow rates with PSC blowers at high system pressures were predicted to yield large increases in space conditioning energy use relative to lower system pressures due primarily to lower capacities and longer system runtimes. Higher system pressures were predicted to yield only slight increases in space conditioning energy use with ECM blowers due primarily to higher fan power draws at nearly constant airflow rates (although fan energy is only a small portion of the total amount of energy used for space conditioning). More specifically, the lowest pressure ductwork designs by both contractors were predicted to decrease annual energy costs for space conditioning in the Chicago home relative to the highest pressure design by ~5-7% with a PSC blower. These savings were 0-3% in most cases in the Chicago home with ECM blowers, and even led to very slight increases in some scenarios due primarily to higher ductwork UA values with the lower pressure designs. Somewhat more drastically, the Austin home results for both contractors suggest that in this home with these duct designs, the combined effects of the lowest duct pressures will likely decrease space conditioning costs relative to the highest pressure designs by 22-25% with a PSC blower installed, but could either increase (as much as +4%) or decrease (as much as -4%) space conditioning costs with an ECM blower installed, depending on duct UA values stemming from individual contractor design details. These results suggest that lower pressure duct designs can yield substantial annual energy savings relative to high pressure duct designs, particularly for PSC blowers. The energy impacts of lower pressure duct systems with ECM blowers were smaller because fan energy is a small fraction of the total amount of energy used for HVAC purposes.

Life cycle cost-benefit

Three different sets of comparisons were then performed to estimate life cycle costs or benefits using both the simulation results and initial design and installation cost estimates from both contractors: (1) comparing low and medium pressure flex duct scenarios to the highest pressure flex scenario, (2) comparing low and medium pressure rigid sheet metal scenarios to the highest pressure rigid sheet metal scenario, and (3) comparing the same pressure designs with both flex duct and rigid sheet metal scenarios to the highest pressure flex duct scenario alone (the latter representing what is typically thought to be the least expensive duct design option). These three comparisons were made separately to provide comparisons between designs that were as realistic as possible; for example, some locations do not allow flexible ductwork so comparing rigid designs to flex designs is not always reasonable. Life cycle cost comparisons were also conducted separately for PSC and ECM blowers because AHU fan costs were not factored into this analysis.

Flex only. For the PSC+flex combinations, lower pressure duct designs were predicted to have 15-year net present values (NPVs) relative to the highest pressure PSC+flex combination ranging from approximately \$430 to \$1670 (positive values represent life cycle savings), depending somewhat on target pressure and more so on contractor design (i.e., the combined effects of duct UA and initial cost estimates). For the Chicago contractor's designs, the medium pressure PSC+flex combinations yielded the highest NPVs; for the Austin contractor's PSC+flex combinations, the lowest pressure PSC+flex combination yielded the highest NPV in the Austin home and results were similar to the medium pressure results in the Chicago home. For ECM+flex systems, 15-year NPVs ranged from a savings of \$37 to an excess cost of \$1435 with the Chicago contractor's designs; the Austin contractor's designs yielded savings in all lower pressure scenarios ranging from \$109 to \$419, again with the medium pressure duct system in the Chicago home having a higher NPV than the low pressure and vice versa in the Austin home. These results suggest that within flexible duct systems only, both medium and low pressure duct systems can result in life cycle costs savings over a 15-year period, particularly for PSC systems and often for ECM systems, although the savings may vary depending on actual duct design characteristics and design and installation costs. In total, the lowest pressure flex duct systems yielded 15-year savings relative to the highest pressure flex duct systems in 6 of 8 model scenarios comparing across two homes, two fan types, and two contractors' designs, while medium pressure flex duct systems yielded 15-year savings in 7 of 8 model scenarios. These results suggest that lower pressure ductwork systems are generally more cost effective if the analysis is restricted to flexible ductwork materials alone.

Rigid only. Limiting life cycle cost comparisons to within rigid sheet metal systems alone, the lower pressure rigid duct designs also generally yielded life cycle cost savings over the highest pressure rigid designs in most of the modeled scenarios. Five out of 8 model scenarios resulted in life cycle savings for the lowest pressure rigid systems relative to the highest pressure rigid systems, and 6 out of 8 scenarios resulted in life cycle savings for the medium pressure rigid duct systems, again summarizing across both homes, both fan types, and both contractors' designs. These results suggest that if one is constrained to using rigid ductwork alone, lower pressure duct designs can also generally lead to life cycle cost savings in these two model homes, particularly for PSC fans, but also for some ECM scenarios. However, the magnitude (and sometimes direction) of savings may vary depending on fan type, level of pressure, and individual

contractor cost estimates and duct design details (that primarily reflect differences in UA values). More specifically, all of the lower pressure duct designs from the Austin contractor yielded life cycle cost savings (ranging from \$460 to \$1510 for PSC+rigid combinations and from \$64 to \$244 for ECM+rigid combinations). The only scenarios that did not yield life cycle savings were those using the Chicago contractor's estimates. Contractor designs alone thus can have a large impact on the economics of lower pressure duct systems in residences.

Flex versus rigid. A final comparison was made across both types of ductwork materials with the highest pressure *flex* duct design as the baseline scenario but again treating PSC and ECM blowers separately. As mentioned, most of the low and medium pressure flex duct designs yielded life cycle cost savings relative to the high pressure flex designs across both homes and both contractor designs. However, none of the rigid duct scenarios yielded life cycle savings over the highest pressure flex systems; initial cost estimates from both contractors were too high relative to any expected life cycle energy cost savings. However, these results should be interpreted with caution because they assume that both flexible and rigid sheet metal duct systems are equally likely to achieve the same target pressures. In reality, flexible ductwork materials are less likely to be able to achieve the lowest system pressures used herein.

Overall, lower pressure flexible ductwork systems combined with PSC blowers were shown to yield life cycle cost savings relative to high pressure flexible duct systems. Lower pressure flexible duct systems with ECM blowers were also shown to yield life cycle cost savings, although the magnitude of savings is lower than with PSC blowers and can vary depending on individual duct design details and contractor cost estimates.

Sensitivity

Results herein were also explored for their sensitivity to a number of important input parameters. For one, extending the duct system life cycle length to 30 years did not drastically affect the results. Second, although some differences in annual energy consumption were predicted to stem from large differences in duct UA values based on the different contractors' designs, controlling for duct UA values also did not drastically influence the outcomes. Third, the modeled homes utilized relatively high efficiency space conditioning equipment, which may have underestimated savings relative to homes modeled with lower efficiency equipment. However, we explored this sensitivity by decreasing the efficiency of air-conditioning units to SEER 13, decreasing the HSPF of the heat pump to 7.7, and decreasing the AFUE of the gas furnace to 80, and demonstrated that the magnitude of savings involved would indeed increase for scenarios with predicted savings, but the number of simulation cases resulting in life cycle savings would not change. These outcomes all suggest that the results and conclusions herein are not highly sensitive to these particular assumptions.

Limitations

There are a number of important limitations to this work that should be mentioned. For example, this work is limited to the particular homes, duct designs, cost estimates, and choices of input parameters used herein. This work also does not capture any changes in system pressures over time; pressures are assumed constant throughout the year (e.g., filters are changed regularly and coil fouling is minimal). This work also assumes that both flexible and rigid sheet metal ductwork have the same likelihood of being installed according to industry quality standards and

therefore can meet the specified design pressures. In reality, flexible ductwork materials are more likely to be constricted during construction due to installation with excessive compression, excessive sag, or being pinched by wires and cables. However, these impacts are not captured herein, which is a very important limitation to these findings. Additionally, this work focuses only on energy consumption impacts and does not explore other factors such as air distribution effectiveness, occupant comfort, indoor air quality, or noise associated with different pressures, fans, and ductwork designs. Also, the NPV analyses herein focuses solely on the duct design and installation costs and modeled energy impacts, and does not account for differences in costs between PSC and ECM blowers. Additionally, duct leakage fractions also remained the same in each model scenario (10% of air handler flow), and were not varied with system pressures. Finally, this work does not explore differences in equipment reliability and maintenance that may differ across the ductwork materials used or between the two blower types. For example, blowers may need to be replaced more often when subjected to excessive static pressures, but we are not aware of accurate ways to estimate replacement times under different operational conditions and thus these impacts remain beyond the scope of this study.

Introduction

Current residential heating, ventilating, and air-conditioning (HVAC) test procedures are limited to testing with external static pressures between 0.1 and 0.2 inches of water column (in. w.c.), or 25-50 Pa (DOE, 2005). Many central residential HVAC systems in the U.S. have substantially higher external static pressures (upwards to 1" w.c. [250 Pa] or higher) due to a combination of common system restrictions, including high pressure drop filters, cooling coils, heating elements, and ductwork (Neme et al., 1999; Proctor and Parker, 2000; ASHRAE, 2004; Lutz et al., 2006; Stephens et al., 2010; Stephens et al., 2010b; Proctor et al., 2011). Among these restrictions, undersized and constricted ductwork is thought to be a key culprit that leads to excess external static pressures that a system must overcome, particularly for compressible flexible ductwork (Abushakra et al., 2002). Excess static pressures can have significant energy impacts depending primarily on the type of blower motor used in the air handling unit (AHU) and the level of excess static pressure (Rodriguez et al., 1996; Parker et al., 1997). It is well known that duct designs should be addressed in the early stages of design (Burdick, 2011); however, information is currently lacking on optimal operational pressures in duct design for central residential HVAC systems.

The impacts of various pressure duct designs on energy consumption are complex, as the relationships between pressure, fan efficiency, fan power draw, airflow rates, and heating and cooling capacities are also complex and depend on the type of fan motor used in the AHU. The energy impacts of duct pressures can be categorized generally into (1) direct power draw requirements of the AHU fan and (2) more complex and indirect relationships between pressure, airflow, delivered sensible and latent capacities, system runtimes, and heat transfer and air leakage across ductwork surfaces and connections if ductwork is installed in unconditioned spaces.

Direct and indirect energy impacts of excess pressure

First, for direct energy impacts, the fan power draw requirements of any AHU fan can be calculated using Equation 1.

$$W_{fan} = \frac{\Delta P_{system} Q_{fan}}{\eta_{fan} \eta_{motor}} \quad (1)$$

where:

W_{fan} = power draw of the fan (W)

ΔP_{system} = external system pressure (Pa)

Q_{fan} = airflow rate ($\text{m}^3 \text{s}^{-1}$)

η_{fan} = efficiency of the fan (-)

η_{motor} = the efficiency of the fan motor (-)

Depending on the type of fan used, the airflow rate (Q_{fan}) and the overall fan and motor efficiency ($\eta_{fan} \times \eta_{motor}$) will respond differently to a specific external static pressure (ΔP_{system}) and thus will have different impacts on fan power draw. The next two sections will describe these energy impacts on PSC and ECM (or BPM) blower motors individually.

PSC blowers

Permanent split capacitor (PSC) motors have traditionally been the most widely used blower motors in residential AHUs with a market share of approximately 90% as of 2002 (Sachs et al., 2002), although the share has decreased in recent years. PSC blowers do not incorporate controls to maintain airflow rates at constant rates. Therefore, when excess system pressures are introduced, airflow rates typically decrease (Parker et al., 1997; Stephens et al., 2010a, 2010b). Figure 1 shows a typical relationship between static pressure, fan power, and fan efficiency as measured in-situ in an operational residential system utilizing a PSC motor (Stephens et al., 2010a).

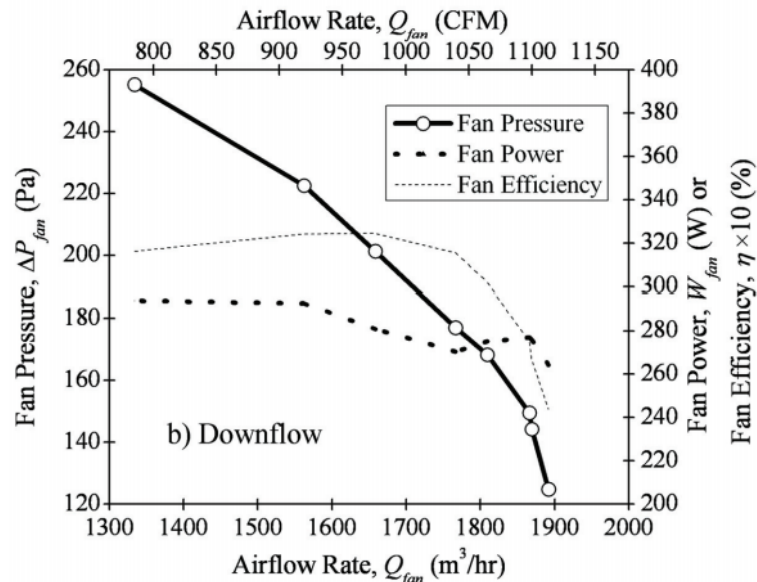

Figure 1. Measured fan curves for a residential AHU with a PSC motor.
Figure taken directly from Stephens et al. (2010a).

For most parts along the curves in Figure 1, increasing the external static pressure will decrease both the airflow rate and the power draw of the PSC blower, although the direction and magnitude of changes in fan power draw depend on the location along the fan efficiency curve. Therefore, for most PSC motors, the direct energy impact of higher static pressures will often be a reduction in fan power draw. However, the overall energy impacts are more complex. Reducing system airflow rates in PSC systems will impact energy consumption primarily by decreasing total cooling capacity of air-conditioning systems (Parker et al., 1997), although sensible and latent capacity impacts are typically nonlinear with flow reductions (Stephens et al., 2010a). Decreased sensible capacity will increase energy consumption by increasing the length of system runtime, although very few measurements of these impacts have been made in actual homes. Capturing these effects is important; because the power draw of compressor-condenser units installed outdoors is typically much larger than the power draw of AHU fans (Stephens et al., 2010a,b), even a small increase in system runtime may overwhelm any savings in fan power draw. Conversely, reduced airflow has been shown to reduce compressor power as well (Parker et al., 1997), which may or may not offset increases in runtime depending on the magnitude of each change. For heat pumps, lower airflow rates will generally decrease both heating and

cooling capacity as well, although the power draw of outdoor units will likely increase (Shen et al., 2011), making these interactions even more complex.

As an example of some of these interactions, the installation of higher-efficiency and higher-pressure drop filters in the same test house system described in Figure 1 was previously shown to increase total external static pressure by 30% from 0.58" w.c. (145 Pa) to 0.75" w.c. (188 Pa). This led to an 11% decrease in system airflow rates from 1010 CFM (1720 m³ hr⁻¹) to 900 CFM (1530 m³ hr⁻¹) but only a 4% decrease in both sensible cooling capacity and coefficient of performance (COP) (Stephens et al., 2010a). The magnitude of reductions in sensible cooling capacity and efficiency were lower than the 11% reduction in airflow in part because both the temperature difference and the humidity ratio difference across the coil actually increased by approximately 7-8%. Overall, one could expect a 4% reduction in sensible cooling capacity to lead to as much as a 4% increase in system runtime and a corresponding 4% increase in cooling energy consumption, all things being equal. However, there were no significant changes in cooling energy consumption in the aforementioned test house at either airflow rate (Stephens et al., 2010). Other recent modeling efforts have predicted that decreasing airflow rates in residential systems with PSC blowers would have negligible (Wilson et al., 2013) or small (Nassif, 2012; Walker et al., 2012) impacts on space conditioning energy consumption. Few other data exist on these complex relationships in real residential environments.

ECM/BPM blowers

Electronically commutated motors (ECM), also known as brushless permanent magnet (BPM) motors, are variable speed motors that can maintain constant or near-constant airflow rates across a wide range of external pressures. ECM blowers typically also have a much higher electric efficiency than PSC motors across a wider range of airflow rates than PSC blowers (Lutz et al., 2004, 2006; Walker, 2006; Franco et al., 2008). In these systems, an increase in system pressure will generally result in the fan drawing more power to maintain the same (or nearly the same) airflow rate (DOE, 2011). Therefore, ECM/BPM motors have a more straightforward relationship with energy consumption in the presence of excess static pressure: they will generally increase fan energy consumption by increasing power draw in response to increased static pressure and maintain the same (or nearly the same) airflow rate, depending on the sophistication of control systems utilized (Genteq, 2010). The absolute magnitude of power draw will still usually be lower than a PSC motor, depending on the magnitude of the pressure increase, because of typically higher efficiencies at most airflow rates. Because ECM blowers work to maintain constant or near-constant airflow rates, altering duct system pressures will not drastically impact indirect energy consumption by altering system runtimes; energy impacts are primarily derived from direct fan power impacts. However, overall space conditioning energy impacts can still be complex and may vary by climate; at higher fan power draws at higher pressures, more excess heat will be rejected into the airstream which may increase cooling energy requirements but may decrease heating energy requirements (Walker et al., 2012).

Given the complexity of these relationships between static pressure, airflow rates, fan power draws, fan efficiencies, sensible and latent capacities, system runtimes, and the combined impacts on space conditioning energy consumption, we have conducted a modeling effort to explore the overall impacts on energy consumption and life cycle costs of various duct designs in single-family homes in the U.S. The duct designs and system configurations utilize several

combinations of external pressures, fan types, and ductwork materials to explore these complex relationships in two hypothetical homes in two climates. The full methodology is described in the next section.

Methodology

In this work, we modeled several combinations of external static pressures, fan types (i.e., both PSC and ECM blowers), and ductwork materials (i.e., flexible ductwork and rigid sheet metal) in central heating and air-conditioning systems using two different single-family home plans in two different climates in order to estimate the energy impacts and overall life cycle costs of operating these residential HVAC systems under a range of ductwork configurations. Simulation results were also used to explore optimal duct static pressures and materials that result in the minimum life cycle costs over an extended period of time (15 or 30 years) in these two typical, new single-family homes.

We obtained estimates of initial design and installation costs for six different duct designs for each home made by residential HVAC contractors located in each of two climate zones: one in Chicago, IL and one in Austin, TX. The designs were intended to explore a range of low, medium, and high external static pressures attributable to the different duct designs as if they were to be designed and actually installed by each contractor. The contractors also provided cost estimates and designs for both flexible duct systems and rigid sheet metal systems to meet each specified level of external static pressure in each home. The intent of using different ductwork materials was to capture differences in both initial cost as well as secondary impacts such as heat transfer across ductwork surface area when installed in unconditioned spaces (Parker et al., 1993; Francisco et al., 1998). The various duct system pressures were then used to predict the impacts on system airflow rates, fan power draws, fan efficiencies, and overall delivered heating and cooling capacity for two different kinds of blower motors: permanent split capacitor (PSC) motors and variable speed electrically commutated motors (ECM). This information was used in conjunction with differences in ductwork characteristics (manifested as differences in duct surface areas) to simulate the annual energy usage for each home in each climate with each duct system. Finally, life cycle costs were estimated for each scenario by combining the estimates of initial design and installation costs from the contractors with differences in results from annual energy simulations of each home and duct design. Results from the scenario matrix were also explored for the combination of duct designs that led to the lowest predicted life cycle cost over an assumed duration of operation of 15 years (with an additional exploration using a 30-year lifespan).

Therefore, the following tasks were completed to fulfill the objectives of this work:

1. Representative single-family home plans were identified for use in (i) the Midwestern and (ii) the Southern United States, represented by Chicago, IL and Austin, TX, respectively.
2. Initial costs to design and install a variety of ductwork systems in the homes were estimated by third party residential heating and air-conditioning contractors (one located in Chicago, IL and one located in Austin, TX).
3. Information from the designs was translated into a format that could be introduced into a whole building energy simulation program to model the operational energy impacts of the various designs. Relationships between pressure, airflow rates, fan power draw, fan efficiency, system capacity, outdoor unit power draw, and others were all estimated at this

stage using data considered generally representative of typical central residential HVAC equipment.

4. Energy simulations were performed in EnergyPlus Version 8.1.0 to estimate the annual space conditioning energy consumption required for operating HVAC systems in both homes with the variety of ductwork system configurations, fan types, and external static pressures.
5. The results from Tasks 2 and 4 were used to estimate differences in life cycle costs of operation for each configuration, including upfront and operational energy costs over an assumed lifetime of 15 years (and repeated again assuming a lifetime of 30 years). These results were also used to determine the ductwork and system combination that minimized life cycle costs among these configurations.
6. A brief sensitivity analysis was performed to elucidate the relative importance of key input parameters.

The methodology for each task is described in more detail below.

Task 1. Identify house plans in two climates

The purpose of Task 1 was to identify house plans for (i) a typical one-story home with a basement in the Midwestern U.S. and (ii) a typical one-story slab-on-grade home in the Southern U.S. The Midwestern home was chosen to have a nominal 1200 CFM air-handling system with ducts installed in the basement. The Southern home was chosen to have a nominal 1600 CFM air-handling system with ducts installed in the attic. These homes were designed to meet or exceed most minimum energy code requirements in both locations according to the 2009 International Energy Conservation Code (IECC). Therefore, the homes modeled herein are considered to be generally consistent with new construction practices in each location.

Two residential HVAC subcontractors (one located in Chicago, IL and one located in Austin, TX) worked to first identify home plans for typical single-family new construction in each location (using Chicago and Austin as the representative locations). Elevation drawings of each selected home are shown in Figure 2. Relevant building characteristics are described in detail in Table 1. These home characteristics provide the baseline design and construction details for use in the simulations described herein. ACCA Manual J calculations were performed by each contractor to size heating and air-conditioning equipment for each home in their respective locations (ANSI/ACCA, 2011a). Load calculations were performed primarily to ensure that the originally specified nominal airflow rates and equipment capacities were indeed appropriate for the two homes. Each contractor also specified off-the-shelf equipment for use in each home as if they were going to perform the actual installation work, although the equipment selection served only to validate assumptions for the nominal flow rates. We selected more generalizable HVAC equipment for use in the modeling procedure, which are not necessarily tied to specific off-the-shelf manufactured products and make our results more generalizable.

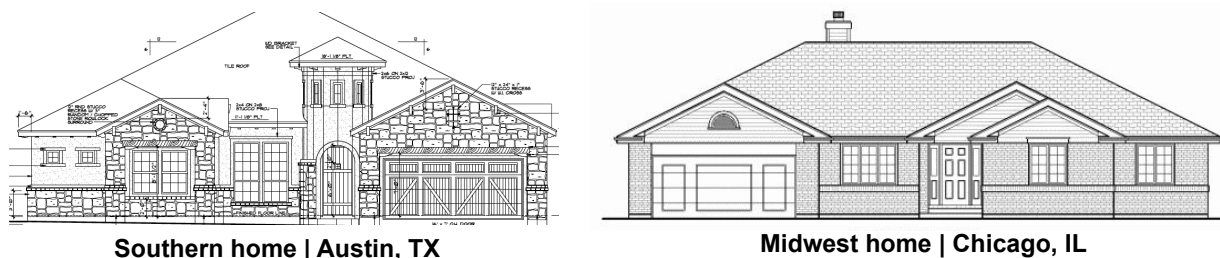

Figure 2. Elevation drawings of each home.

Table 1. Baseline characteristics of each IECC 2009 compliant home in each location

	Austin, TX	Chicago, IL
Floor area (ft ²)	3,154	2,101
Orientation	Front door faces southeast	Front door faces east
Floor construction	Slab on grade	R-30 floor insulation over full unconditioned basement
Number of bedrooms	3	3
Number of bathrooms	2	2
Exterior materials	Stucco and stone exterior	Brick veneer
Wall insulation (h·ft ² ·°F/Btu)	R-19 in 2x6 exterior walls	R-21 in 2x6 exterior walls
Attic insulation (h·ft ² ·°F/Btu)	R-38 in roof deck	R-38 in roof deck
Window U-value (Btu/h·ft ² ·°F)	0.35	0.35
Window SHGC	0.30	0.55
Window area, F B L R (ft ²)	89, 200, 120, 36	48, 112, 9, 12
Duct/AHU location	Unconditioned attic	Unfinished basement
Duct insulation (h·ft ² ·°F/Btu)	R-6	R-6
Duct leakage (%)	10%	10%
Envelope airtightness	7 ACH ₅₀	7 ACH ₅₀
Manual J AHU airflow rate (CFM)	1888	1307
Manual J sensible design load (Btu/hr)	35,729	28,078
Manual J latent design load (Btu/hr)	4,789	5,523
Manual J total cooling design load (Btu/hr)	40,517	33,601
Manual J heating design load (Btu/hr)	45,266	46,387
Modeled HVAC equipment	4-ton heat pump 15 SEER 1-stage 8.5 HSPF	3-ton AC unit 15 SEER 1-stage 92.5% AFUE 68 kBtu/hr gas furnace
Nominal AHU airflow rate (CFM)	1600 @ 0.5" w.c.	1200 CFM @ 0.5" w.c.
Nominal cooling capacity (Btu/hr)*	48,000 (SHR = 0.74)	36,000 (SHR = 0.74)
Nominal heating capacity (Btu/hr)*	48,000 (+ 10,000 suppl.)	68,000

*Model system capacities reflect values modeled at the nominal (highest) airflow rate assumed for each home.

The Austin home was considerably larger than the Chicago home. The Austin home was a 1-story slab-on-grade stucco and stone veneer home with R-19 (IP) exterior walls and R-38 (IP) attic floor insulation. Windows had a U-value of 0.35 (IP) and a solar heat gain coefficient (SHGC) of 0.30. Ducts (R-6 IP, 10% leakage split two-thirds supply side and one-third return side) were installed in the unconditioned attic. The envelope was assumed to have an airtightness of 7 air changes per hour at 50 Pa (ACH_{50}). A generic 15 SEER 1-stage 4-ton heat pump with an 8.5 HSPF was chosen as primary space conditioning equipment, with an additional 10 kBtu/hr of supplemental strip heat.

The Chicago home was a 1-story brick veneer home with R-21 (IP) exterior walls and R-38 (IP) attic floor insulation, built over an unconditioned basement (with R-30 floor insulation installed over the basement). Windows had a U-value of 0.35 (IP) and an SHGC of 0.55. Ducts (R-6 IP, 10% leakage split two-thirds supply side and one-third return side) were installed in the unconditioned basement. The envelope was also assumed to have an airtightness of 7 ACH_{50} . Heating was provided by a generic 1-stage 15-SEER 3-ton air-conditioning unit and heating was provided by a 92.5% AFUE natural gas furnace with a capacity of 68 kBTU/hr.

Task 2. Estimate installation costs of ductwork

In this study, we specified a range of external pressures (ΔP_{system}) to explore based on the original project work statement. These pressures were chosen to represent the total pressure introduced by a combination of ductwork, coils, filters, supply registers, and return grilles. Table 2 summarizes (i) external static pressures introduced by ducts alone and (ii) total external static pressures associated with each targeted design after assuming an additional 0.35" w.c. (87 Pa) is introduced by the combination of filters (0.10" w.c.; 25 Pa), coils (0.16" w.c.; 40 Pa), registers (0.03" w.c.; 8 Pa), and grilles (0.03" w.c.; 8 Pa). These assumptions are widely used in many ACCA Manual D calculations (ANSI/ACCA, 2011b).

Table 2. Duct and total static pressure targets for the duct designs in each home

Duct Scenario	Chicago, IL		Austin, TX	
	Duct pressure	Total external static pressure	Duct pressure	Total external static pressure
Low pressure (baseline)	0.15" w.c. (38 Pa)	0.50" w.c. (125 Pa)	0.20" w.c. (50 Pa)	0.55" w.c. (138 Pa)
Medium pressure	0.45" w.c. (113 Pa)	0.80" w.c. (200 Pa)	0.50" w.c. (125 Pa)	0.85" w.c. (213 Pa)
High pressure	0.75" w.c. (188 Pa)	1.10" w.c. (275 Pa)	0.80" w.c. (200 Pa)	1.15" w.c. (288 Pa)

The specified pressures were used by each of the contractors in performing ACCA Manual D calculations to size different ductwork designs and materials to achieve each external pressure in each home (ANSI/ACCA, 2011b). Each contractor provided their designs along with a cost estimate for the design and installation of each duct system in each climate as if they were to actually perform the installation. Duct designs were also made for each target pressure using two different duct materials: (1) flex ductwork and (2) rigid metal ductwork. Both contractors performed duct designs and cost estimates for each home; therefore, their results captured regional variations in material costs, design layouts, labor costs, and construction practices.

It should be noted that although the system pressures identified in Table 2 are mostly higher than standard industry assumptions and test conditions (DOE, 2005), they actually compare very well with existing measurements of pressures in real homes across the U.S. For example, in a study of

60 new homes in California, total external pressures during cooling periods ranged from ~0.3” w.c. (75 Pa) to ~1.2” w.c. (300 Pa) (Wilcox et al., 2006). The median external static pressure was 0.75” w.c. (188 Pa), with median contributions of 0.18” w.c. (45 Pa) from supply ducts; 0.27” w.c. (68 Pa) from cooling coils; 0.15” w.c. (38 Pa) from return ducts; and 0.15” w.c. (38 Pa) from filters.

Similar results were also found in approximately 50 homes in another recent study in California (Proctor et al., 2011). In this study, the average supply plenum, cooling coil, and return plenum pressures were as follows: supply ducts (ducts + registers): 0.18” w.c. (45 Pa); cooling coil: 0.22” w.c. (55 Pa); and return ducts (ducts + grilles + filters): 0.47” w.c. (118 Pa). Total external static pressures (supply + return + coil) ranged from ~0.55” w.c. to ~1.2” w.c. (138 to 300 Pa). Excluding coils, these ranged from 0.25” to 1.0”. These values suggest that the range of total external pressures identified in Table 2 will appropriately encompass a wide range of static pressures measured in actual homes. These also align well with other field studies (Stephens et al., 2010a, 2010b; Stephens et al., 2011, 2010c). The full matrix of simulation cases is shown in Table 3.

Table 3. Matrix of simulations to run for this project

Home #1	Duct Type	Blower Motor	Duct Pressures	Total Pressures	Home #2	Duct Type	Blower Motor	Duct Pressures	Total Pressures
Midwestern home Ducts in basement 1200 CFM airflow Nominal 3-ton AC unit	Metal	PSC	0.15" (38 Pa)	0.50" (125 Pa)	Southern home Ducts in attic 1600 CFM airflow nominal 4-ton heat pump	Metal	PSC	0.20" (50 Pa)	0.55" (138 Pa)
			0.45" (113 Pa)	0.80" (200 Pa)				0.50" (125 Pa)	0.85" (213 Pa)
			0.75" (188 Pa)	1.10" (275 Pa)				0.80" (200 Pa)	1.15" (288 Pa)
		ECM	0.15" (38 Pa)	0.50" (125 Pa)			ECM	0.20" (50 Pa)	0.55" (138 Pa)
			0.45" (113 Pa)	0.80" (200 Pa)				0.50" (125 Pa)	0.85" (213 Pa)
			0.75" (188 Pa)	1.10" (275 Pa)				0.80" (200 Pa)	1.15" (288 Pa)
	Flex	PSC	0.15" (38 Pa)	0.50" (125 Pa)	Flex	PSC	0.20" (50 Pa)	0.55" (138 Pa)	
			0.45" (113 Pa)	0.80" (200 Pa)			0.50" (125 Pa)	0.85" (213 Pa)	
			0.75" (188 Pa)	1.10" (275 Pa)			0.80" (200 Pa)	1.15" (288 Pa)	
		ECM	0.15" (38 Pa)	0.50" (125 Pa)		ECM	0.20" (50 Pa)	0.55" (138 Pa)	
			0.45" (113 Pa)	0.80" (200 Pa)			0.50" (125 Pa)	0.85" (213 Pa)	
			0.75" (188 Pa)	1.10" (275 Pa)			0.80" (200 Pa)	1.15" (288 Pa)	

Task 3. Translate ductwork designs to energy modeling software and estimate impacts of system pressures on power draw, airflow, and system capacity

The external static pressures used in each duct design and system configuration were first used to estimate the impacts of duct pressures on fan airflow rates, fan efficiency, and fan power draw. EnergyPlus has built-in polynomial functions that calculate sensible and latent capacity, COP, and outdoor unit power draw as a function of airflow rates, so only fan-related inputs were required in the simulation. These fan-related inputs were all determined separately based on PSC and ECM blowers. In the following sections we also discuss the likely impacts of lower airflow rates on the capacities of the air-conditioning, gas furnace, and heat pump systems, although those values are not used directly in this work because of our reliance on the appropriate functions in EnergyPlus. Finally, we estimated duct surface areas and duct UA values based on

the contractor duct designs to capture indirect energy impacts of ducts installed in unconditioned spaces.

This work was thus performed according to the following three subtasks:

- Subtask 3.1: Identifying representative flow, pressure, and power data for AHU impacts
- Subtask 3.2: Identifying likely changes in system capacities, efficiencies, and outdoor unit power draws based on airflow responses from Subtask 3.1
- Subtask 3.3: Estimating duct surface areas based on contractor designs

These tasks were performed assuming that the system pressures in Table 3 impact a nominally sized air-handling unit and space conditioning equipment. In reality, if a contractor discovered excessive external static pressures, he or she may increase fan speeds or even install a larger AHU in order to achieve proper airflow rates. However, we do not capture that potential herein and simply assume that the same AHU and fan speed settings are used in each pressure condition. This should capture the largest possible energy impacts introduced by high duct pressures. We also assume that ductwork configurations are installed according to industry quality standards (i.e., with minimal duct compression or sag) and that both flexible and rigid sheet metal ductwork materials are equally likely to be able to achieve the target pressures. However, in reality, flexible ductwork is more likely to become compressed or constricted because of improper installation than rigid sheet metal ductwork.

Subtask 3.1: Identifying representative airflow, pressure, and power data for AHU fans

We attempted to select data from the most widely representative HVAC equipment for use in the modeling efforts herein because outcomes of the energy simulations are strongly influenced by both the quality of the input data and the representativeness of the type of equipment chosen. This means that high quality data are needed for a wide range of both ECM and PSC blowers and for air-conditioning units with gas furnaces (in the Chicago home) and for heat pumps (in the Austin home). In addition to quality of data, we have chosen data for HVAC equipment that would be considered generally representative of as many homes in the U.S. as possible. Therefore, after surveying manufacturer data (e.g., Lutz et al., 2004; DOE, 2011), soliciting input from our subcontractors, and surveying laboratory experimental data (e.g., Walker, 2006), we decided to use data from a large summary of manufacturer fan data provided in Appendix 7-F of the *Technical Support Document for the Energy Efficiency Program for Consumer Products: Residential Central Air Conditioners, Heat Pumps, and Furnaces* (DOE, 2011). In this report, the authors selected data from dozens of fan manufacturers to summarize airflow rate responses to external static pressures for a wide range of both PSC and ECM blowers. Polynomial curve fits were established for both types of fans and for a variety of furnace models. We rely on the “virtual models” created in their report based on the established average curve fits therein. We rely on their estimates for 3-ton units (and 1200 CFM nominal) for the Chicago home and 4-ton units for the Austin home (and 1600 CFM nominal).

PSC Blowers. Average fan curves (airflow vs. pressure) and fan efficiency curves (W/CFM vs. pressure) for a range of single-stage virtual model furnaces with PSC blowers are shown in Figure 3.

PSC Blowers

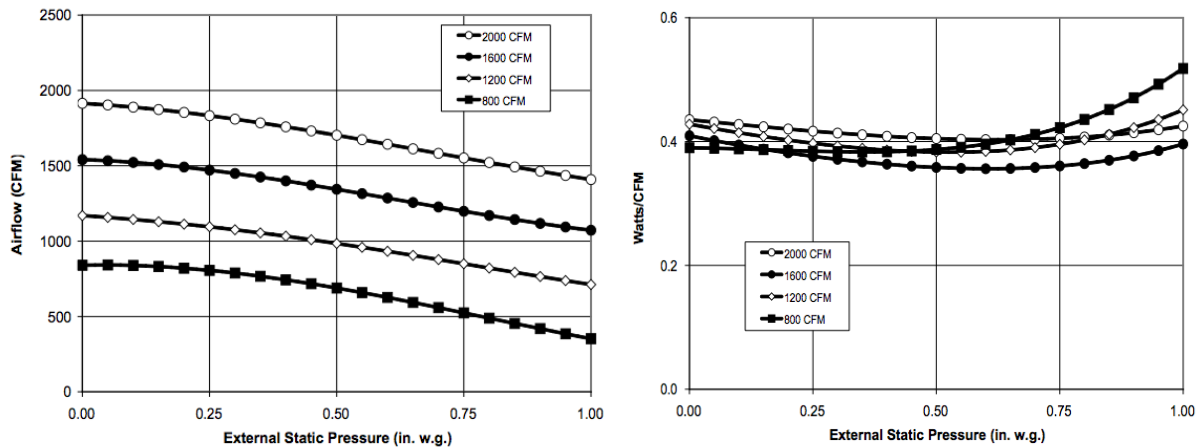

Figure 3. Fan airflow and fan efficiency curves for single-stage virtual models of PSC furnaces with four different blower sizes (figure taken directly from DOE, 2011).

These virtual models show that excess static pressure will indeed decrease airflow rates in PSC blowers. Fan efficiency (in Watts/CFM) will remain largely constant until pressures in excess of 0.75” w.c. (188 Pa), meaning that fan power draw will generally decrease with decreases in fan flow. These data are considered appropriate and align well with the background information in this report.

ECM Blowers. Similarly, average fan curves (airflow vs. pressure) and fan efficiency curves (W/CFM vs. pressure) for a range of single-stage virtual model furnaces with ECM blowers are shown in Figure 4.

ECM Blowers

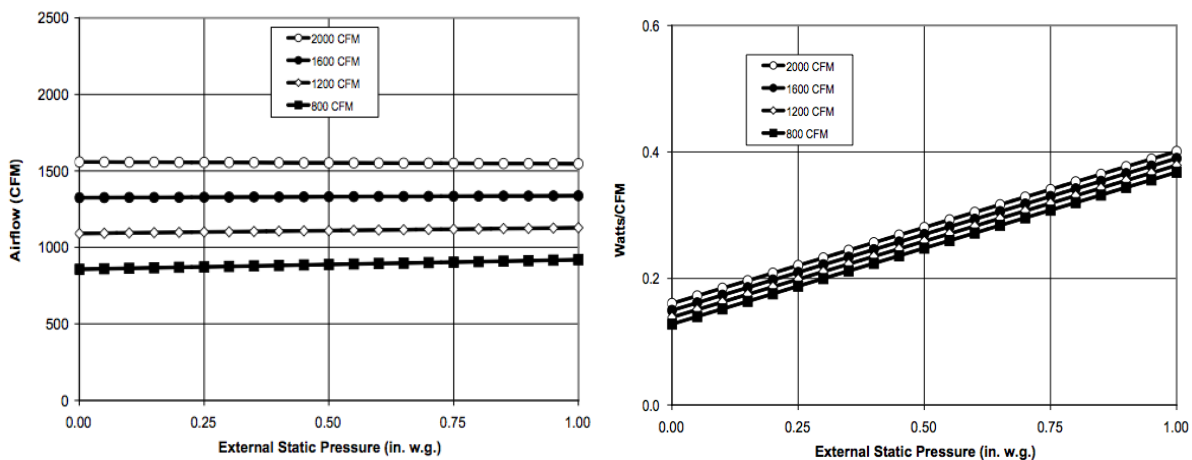

Figure 4. Fan airflow and fan efficiency curves for two-stage virtual models of ECM furnaces with four different blower sizes (figure taken directly from DOE, 2011).

In Figure 4, these representative ECM blowers act as near-constant flow ECM blowers with fan power draw per unit airflow rate increasing approximately linearly with increases in airflow. Curve fits to the data in Figure 3 and Figure 4 were used from the technical support document to extend the range of external pressures beyond the scale shown in the figures.

Curve fits for each fan type are summarized as follows. Airflow (in CFM) is given by the empirical formula in Equation 2. Fan efficiency (in Watts/CFM) is given by the empirical formula in Equation 3.

$$CFM = x_0 + x_1P + x_2P^2 \quad (2)$$

$$\frac{Watts}{CFM} = y_0 + y_1P + y_2P^2 \quad (3)$$

where P = external system pressure (in. w.c.), CFM = airflow rate (CFM), and $Watts/CFM$ = power draw per unit airflow (W/CFM). Coefficients for both Equation 2 (airflow) and Equation 3 (fan efficiency) for the 3-ton and 4-ton units (1200 CFM and 1600 CFM nominal airflow rates, respectively) are shown in Table 4.

Table 4. Airflow and fan efficiency coefficients for the PSC and ECM blowers

Unit	x₀	x₁	x₂	y₀	y₁	y₂
PSC blowers	Airflow rates (CFM)			Fan efficiency (W/CFM)		
3-ton (1200 CFM nominal)	1158.0	-12.1	-507.2	0.432	-0.209	0.185
4-ton (1600 CFM nominal)	1522.7	-40.3	-537.0	0.416	-0.191	0.156
ECM blowers						
3-ton (1200 CFM nominal)	1043.2	23.5	-101.1	0.160	0.239	-0.029
4-ton (1600 CFM nominal)	1326.2	57.6	-61.9	0.170	0.311	-0.084

Figure 5 summarizes the airflow rates and fan power draws utilized in this work at each of the three pressures outlined previously for each home (and for both PSC and ECM blowers). Absolute relationships between flow and power at each pressure were first identified using the coefficients in Table 4. Subsequently, the relative relationships from these curves were used to align the data to the nominal flows (i.e., those maximum flows at the lowest pressures) that were previously outlined (1200 CFM nominal for the Chicago home and 1600 CFM nominal for the Austin home, both at 0.5" w.c. or 0.55" w.c.). These provide the primary inputs in terms of AHUs for this study.

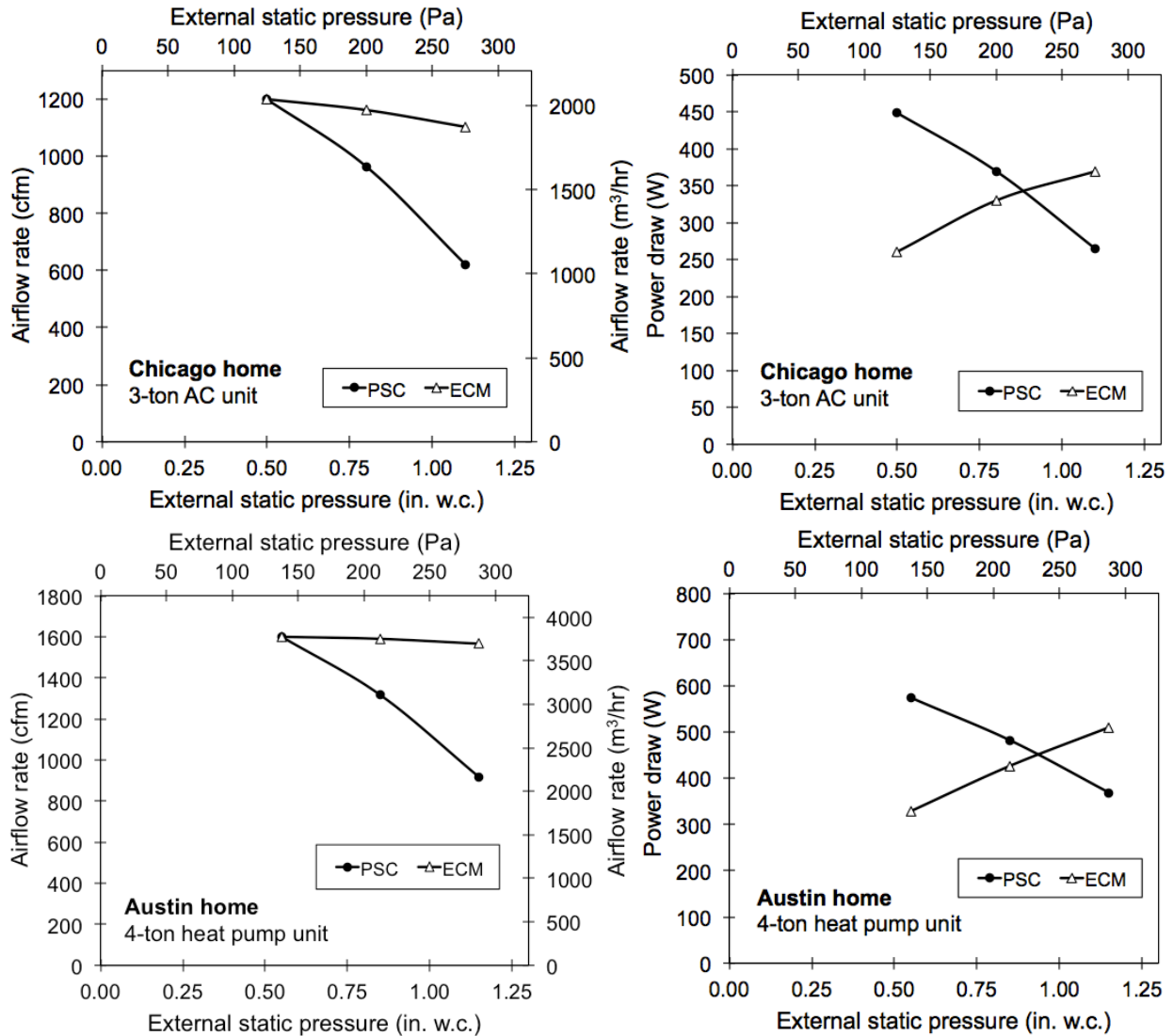

Figure 5. Summary of airflow rate and fan power draw inputs utilized at each of the low, medium, and high external static pressures in this work for both PSC and ECM blowers for use in simulations herein.

For both PSC and ECM blowers, nominal airflows of 1200 CFM and 1600 CFM were assumed to be achieved in the Chicago and Austin homes at the lowest external static pressures of 0.5” w.c. (125 Pa) and 0.55” w.c. (138 Pa), respectively. Increases in external static pressure to 0.80” w.c. (Chicago) or 0.85” w.c. (Austin) were predicted to yield 20% and 18% reductions in flow for the PSC blowers and 3% and 1% reductions in flow for ECM blowers, respectively. Similarly, increases in external static pressure to 1.10” w.c. (Chicago) and 1.15” w.c. (Austin) were predicted to yield 48% and 43% reductions in flow for PSC blowers and 8% and 2% reductions in flow for ECM blowers, relative to the low pressure cases.

For the Chicago home, these flow changes correspond to as much as a 41% reduction in fan power draw (PSC) and as much as a 42% increase in fan power draw (ECM) at the highest pressure. At the highest pressure the PSC blower actually drew less power than the ECM blower. Similarly for the Austin home, the highest pressure yielded a 36% decrease in fan power draw

for the PSC blower and a 55% increase in fan power draw for the ECM blower; power draw was approximately equal for both blowers at the highest pressure.

These pressure, flow, and power draw changes are generally consistent not only with manufacturer data but with data from laboratory and field tests (Parker et al., 1997; Walker, 2006; Stephens et al., 2010, 2010a, 2010b), and thus should be considered generally representative of the range of equipment and operational conditions observed in homes across the country. The absolute values of the full range of pressure, airflow, fan power draw, and fan efficiency inputs for each simulation case in both homes are shown in Table 5.

Table 5. Summary of power, flow, and capacity inputs for the EnergyPlus simulations

Home	Duct type	Blower type	Total pressure (in. w.c.)	Airflow rate (CFM)	Fan + motor efficiency (%)	Fan power draw (W)
Chicago 3-ton AC Gas furnace 1200 CFM nominal	Flex	PSC	0.50"	1200	0.16	449
			0.80"	964	0.25	369
			1.10"	622	0.30	265
		ECM	0.50"	1200	0.27	260
			0.80"	1162	0.33	330
			1.10"	1103	0.39	369
	Metal	PSC	0.50"	1200	0.16	449
			0.80"	964	0.25	369
			1.10"	622	0.30	265
		ECM	0.50"	1200	0.27	260
			0.80"	1162	0.33	330
			1.10"	1103	0.39	369
Austin 4-ton heat pump 1600 CFM nominal	Flex	PSC	0.55"	1600	0.18	573
			0.85"	1316	0.27	482
			1.15"	916	0.34	369
		ECM	0.55"	1600	0.32	329
			0.85"	1590	0.37	427
			1.15"	1566	0.42	510
	Metal	PSC	0.55"	1600	0.18	573
			0.85"	1316	0.27	482
			1.15"	916	0.34	369
		ECM	0.55"	1600	0.32	329
			0.85"	1590	0.37	427
			1.15"	1566	0.42	510

Subtask 3.2: Identifying likely changes in system capacities based on airflow responses

Once airflow and fan power draw impacts in response to the defined static pressures were identified, Subtask 3.2 identified the likely impacts of airflow on heating and cooling capacity, efficiency, and outdoor unit power draw for each home and system. Again, these were not used directly as inputs in EnergyPlus, but were captured in the built-in polynomial functions that link capacity and efficiency (or the coefficient of performance, COP) to airflow rates. The same airflow rates were assumed to be used in both heating and cooling modes for simplicity.

Cooling capacities. First, likely sensible, latent, and total cooling capacities in response to the aforementioned range of airflow rates in each home were identified. Several existing studies were summarized to establish these relationships (Rodriguez et al., 1996; Parker et al., 1997). Parker et al. (1997) reported on results from both simulations and laboratory experimental studies of the impacts of reduced airflow on air-conditioning capacity. Rodriguez et al. (1996) reported on similar laboratory experiments of a heat pump unit operating at reduced airflow under a range of conditions, including operating with both a thermal expansive valve (TXV) and fixed orifice control system. Figure 6 describes relative impacts of important air-conditioning capacity and power parameters in response to decreased airflow rates from laboratory testing in Parker et al. (1997), which were used primarily in this work. These results compared well with those in Rodriguez et al. (1996) and to other work using detailed equipment simulations (Brandemuehl et al., 1993; Nassif, 2012).

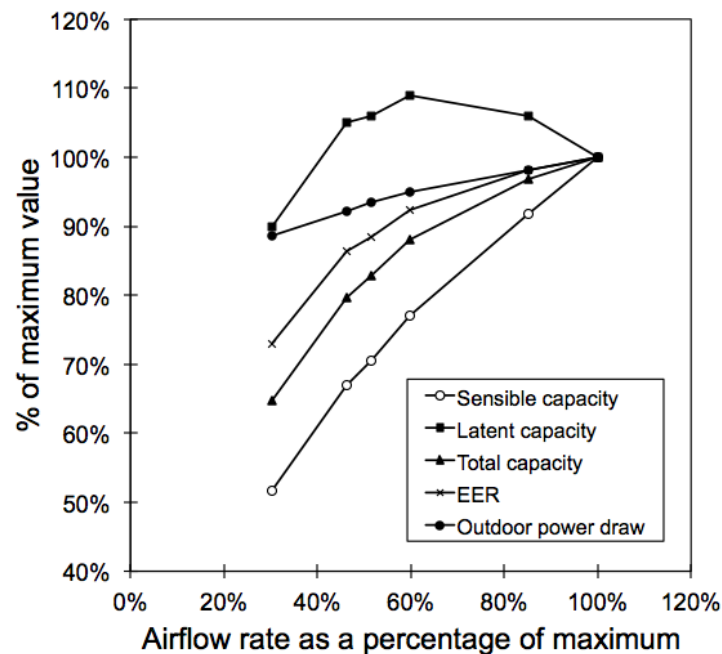

Figure 6. Relative impacts of sensible capacity, latent capacity, total capacity, EER, and outdoor unit power draw in response to decreases in airflow rates (data from Parker et al. 1997). Maximum airflow values are taken as ~425 CFM per ton in Parker et al. (1997) and are assumed to coincide with nominal airflow rates outlined previously for use in this work.

The relationships in Figure 6 are valid for both homes in the cooling mode (Chicago utilizing a traditional DX system and Austin utilizing a heat pump). Likely changes in total cooling capacity, sensible cooling capacity, latent capacity, and outdoor compressor power draw are

shown in Table 6 based on each change in airflow at each system pressure for each of the fan types in each location.

Table 6. Likely changes in cooling system performance in response to changes in airflow rates for the homes and conditions herein. Data are from Parker et al. (1997).

Home	Blower type	Total pressure	Airflow rate	Total capacity	Sensible capacity	Latent capacity	Compressor power draw
Chicago	PSC	Low	-	-	-	-	-
		Medium	-20%	-5%	-10%	+7%	-3%
		High	-48%	-18%	-29%	+6%	-6%
	ECM	Low	-	-	-	-	-
		Medium	-3%	-1%	-3%	+1%	0%
		High	-8%	-2%	-4%	+3%	-1%
Austin	PSC	Low	-	-	-	-	-
		Medium	-18%	-5%	-10%	+7%	-2%
		High	-43%	-12%	-23%	+9%	-5%
	ECM	Low	-	-	-	-	-
		Medium	-1%	0%	0%	0%	0%
		High	-2%	-1%	-2%	+1%	0%

Heating capacities. Heating capacity for the gas furnace in the Chicago home was linked directly to the airflow rate in the simulations (Walker et al., 2002). However, separate relationships were used for heating mode performance of the heat pump in the Austin home. For example, in a recent study of a 3-ton air-source heat pump operating in the heating mode, Shen et al. (2011) provided data for steady-state experimental heating performance under a variety of conditions, including varying airflow rates. They performed tests on the same heat pump unit with both a fixed-area expansion orifice (FEO) and a thermal expansion valve (TXV) installed separately. They directly measured heating capacity and compressor power draw at each flow rate and under a range of refrigerant charge conditions. Only the data from 100% charge conditions are included here. Figure 7 shows the relative response of both heating capacity and compressor power draw to changes in airflow rates at 100% charge conditions for the tested system with both types of metering devices installed and as tested at three different outdoor operating conditions. Values are shown as a fraction of nominal values (i.e., as a fraction of that measured at nominal flow). Each line represents three data points.

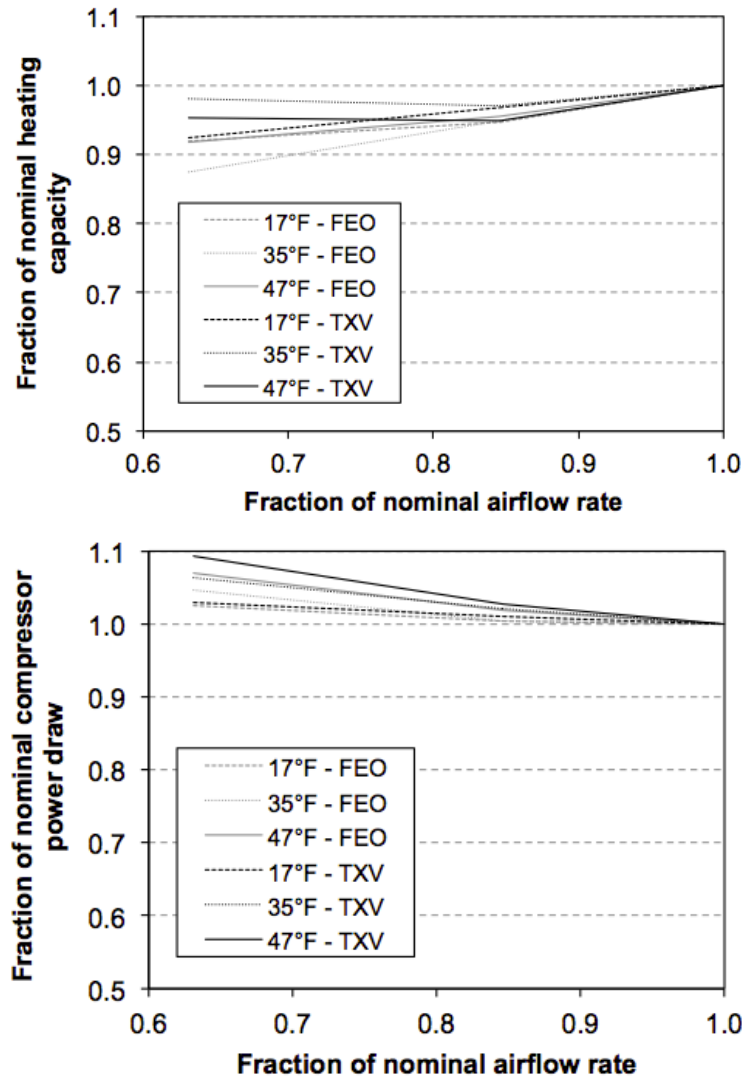

Figure 7. Heat pump performance as a function of nominal airflow rate for a range of two expansion valve types and three different outdoor air temperatures; data taken directly from experimental results in Shen et al. (2011).

Heating performance degradation at lower airflow rates was shown to be much smaller than the degradation of cooling performance for the heat pump unit in this study. Across both types of metering devices and across all three outdoor air temperatures, the reduction in heating capacity was ~2-6% with a 15% reduction in airflow and ~2-13% with a 37% reduction in airflow. Conversely, the compressor power draw increased ~1-4% and ~2-10% at those same reductions in airflow rates. These results are similar to other recent studies on other residential heat pumps (Kruse et al., 2008; Payne et al., 2010; Palmiter et al., 2011) and suggest that lower airflow rates will increase heating energy in the modeled homes both by increasing runtimes and by drawing more power while operating.

Subtask 3.3: Estimating ductwork surface areas

Finally, the actual ductwork designs provided by the subcontractors (in Task 2) were translated into a format conducive to incorporating into the energy simulation program, EnergyPlus. The

most relevant inputs culled from each ductwork design included ductwork R-values and, most importantly, the surface areas of supply and return ductwork installed in unconditioned spaces (which varied by duct design). Each of these affects the overall UA values for ductwork, which is particularly important for ductwork installed in unconditioned spaces (Parker et al., 1993; Francisco et al., 1998; ASHRAE, 2004b). Supply and return ductwork surface areas of each ductwork design were estimated manually based on the size and shape of ductwork provided by the contractors (i.e., by calculating the surface area of a cylinder of the same length and diameter as each duct run). Those values were converted into UA values for each scenario based on an assumed level of ductwork insulation of $R=6 \text{ h}\cdot\text{ft}^2\cdot^\circ\text{F}/\text{Btu}$ ($U = 0.167 \text{ Btu}/\text{h}\cdot\text{ft}^2\cdot^\circ\text{F}$).

The ductwork designs for lower external static pressures generally utilized greater diameter ductwork that was typically running similar lengths (the greater diameter allows for lower resistance for an equivalent length). Therefore, the external surface area of ductwork was typically higher for the lower static pressure designs, although there was considerable variability between each contractor's designs. Designs by the Chicago contractor resulted in UA values for ductwork that were typically 20-30% higher for the lower pressure (larger diameter) duct systems relative to the highest pressure (smaller diameter) duct systems; designs by the Austin contractor resulted in UA values that were between 2% and 15% higher for the lower pressure systems. Additionally, the Austin contractor tended to use more efficient duct designs in terms of material; their duct UA values were often 20-40% lower than the Chicago contractors. Example duct design layouts by each contractor for just one flex duct scenario in the Chicago home are shown in Figure 8 and Figure 9. In Figure 8, the Austin contractor utilized flexible duct trunks and branches to achieve the desired pressure for that scenario. In Figure 9, the Chicago contractor utilized a radial flex duct design where each branch began at the AHU (this is often referred to "ductopus" configuration by building scientists as the branches resemble a cephalopod's tentacles). The surface areas of these designs may not accurately represent the designs of other contractors; later in this report we also explore the sensitivity of the simulation results to these inputs by controlling for duct UA (refer to page 30).

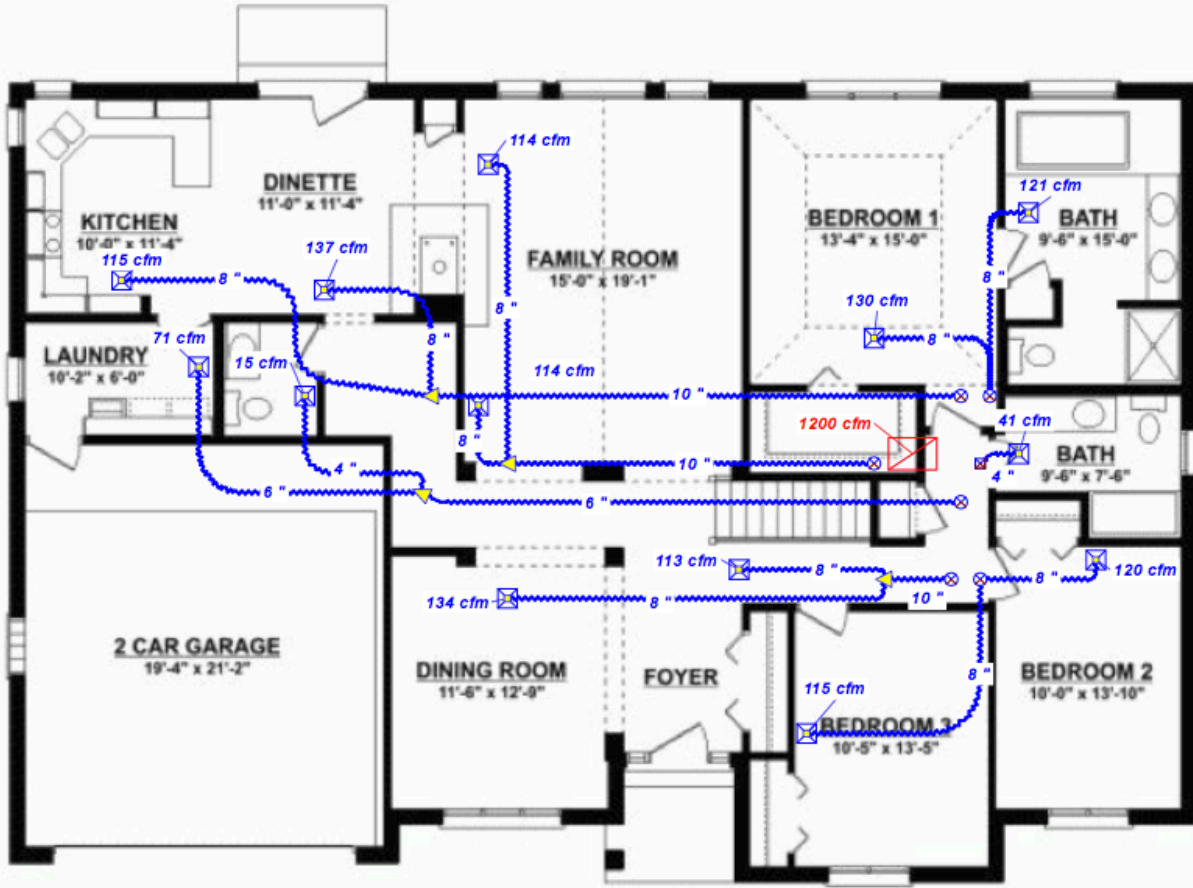

Figure 8. Example duct design layout for the Chicago home by the Austin contractor using flexible ductwork materials.

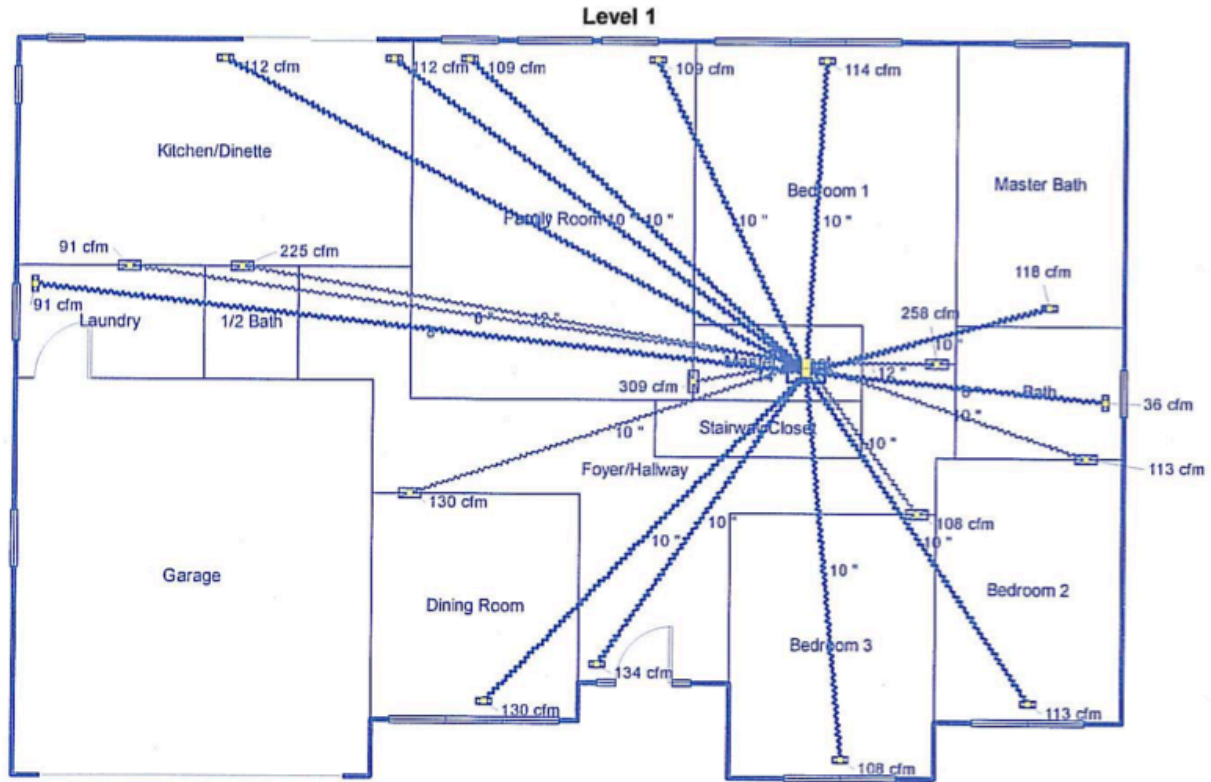

Figure 9. Example duct design layout for the Chicago home by the Chicago contractor using flexible ductwork materials

Combined, these differences in duct UA values both between contractors and between homes were expected to have energy implications in terms of heat transfer of conditioned supply air or return air across insulated ductwork located in the unconditioned attic or basement spaces. Full inputs for ductwork UA values are shown in Table 7 for each home and simulation case.

Table 7. Duct UA values used in the energy simulations, estimated using duct designs from both contractors

Home	Duct type	Blower	Total Pressure (in. w.c.)	Duct UA (Btu/h·°F)		Duct UA (Btu/h·°F)	
				Chicago contractor		Austin contractor	
				Supply	Return	Supply	Return
Chicago 3-ton AC unit Gas furnace 1200 CFM nominal	Flex	PSC	0.50"	225.0	111.0	165.2	1.4
			0.80"	169.7	90.3	133.4	0.5
			1.10"	161.2	84.0	143.2	0.5
		ECM	0.50"	225.0	111.0	165.2	1.4
			0.80"	169.7	90.3	133.4	0.5
			1.10"	161.2	84.0	143.2	0.5
	Metal	PSC	0.50"	139.5	66.7	116.5	0.5
			0.80"	110.8	51.1	114.5	0.5
			1.10"	107.2	51.1	114.0	0.5
		ECM	0.50"	139.5	66.7	116.5	0.5
			0.80"	110.8	51.1	114.5	0.5
			1.10"	107.2	51.1	114.0	0.5
Austin 4-ton heat pump 1600 CFM nominal	Flex	PSC	0.55"	323.2	110.5	199.8	40.7
			0.85"	263.7	108.1	189.8	37.7
			1.15"	259.1	108.1	183.9	37.7
		ECM	0.55"	323.2	110.5	199.8	40.7
			0.85"	263.7	108.1	189.8	37.7
			1.15"	259.1	108.1	183.9	37.7
	Metal	PSC	0.55"	158.0	92.4	205.0	1.7
			0.85"	135.0	86.1	186.5	1.7
			1.15"	125.8	82.8	183.5	1.7
		ECM	0.55"	158.0	92.4	205.0	1.7
			0.85"	135.0	86.1	186.5	1.7
			1.15"	125.8	82.8	183.5	1.7

Task 4. Estimate annual operating energy use for each scenario

Each combination of HVAC system, AHU fan, home, climate, and duct design was modeled in an energy modeling software package, EnergyPlus Version 8.1.0, for a typical year using the appropriate (Chicago and Austin) typical meteorological year (TMY3) data. EnergyPlus was developed and made available by the US Department of Energy (DOE). It uses its own hourly simulation engine and allows for tremendous flexibility in choosing appropriate inputs for fan characteristics that are crucial to this project. Because EnergyPlus does not have an inherent graphical user interface, we used the BEopt Version 2.1.0.0 software package (also designed and made available by the US DOE) to generate basic input files (*.idf files) for each of the two homes for use with EnergyPlus, which were then modified in the EnergyPlus IDF Editor (or in a separate text file) to account for varying fan pressure, fan efficiency, airflow, fan power draw, and duct UA inputs for each simulation case. The general modeling procedures are outlined below.

Energy modeling procedures

Each home was first modeled in BEopt with the building shell and generic air-source HVAC system reflecting inputs described in Table 1. BEopt allows for rapid geometry construction based on a footprint alone. The home models and footprints are shown in Figure 10 and Figure 11. Model geometry was simplified from the actual house plans in Figure 2 to limit simulation time and potential geometry errors. Window-to-wall ratios were adjusted based on the house plans and are reflected in Table 1.

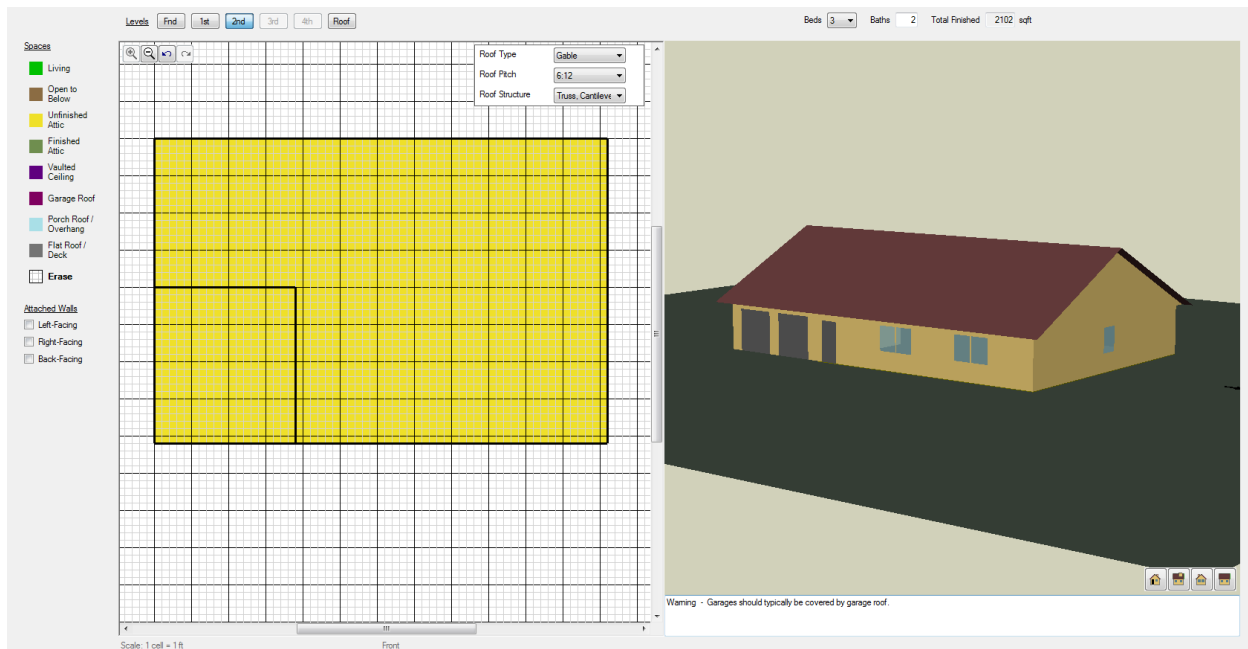

Figure 10. Chicago home model in BEopt.

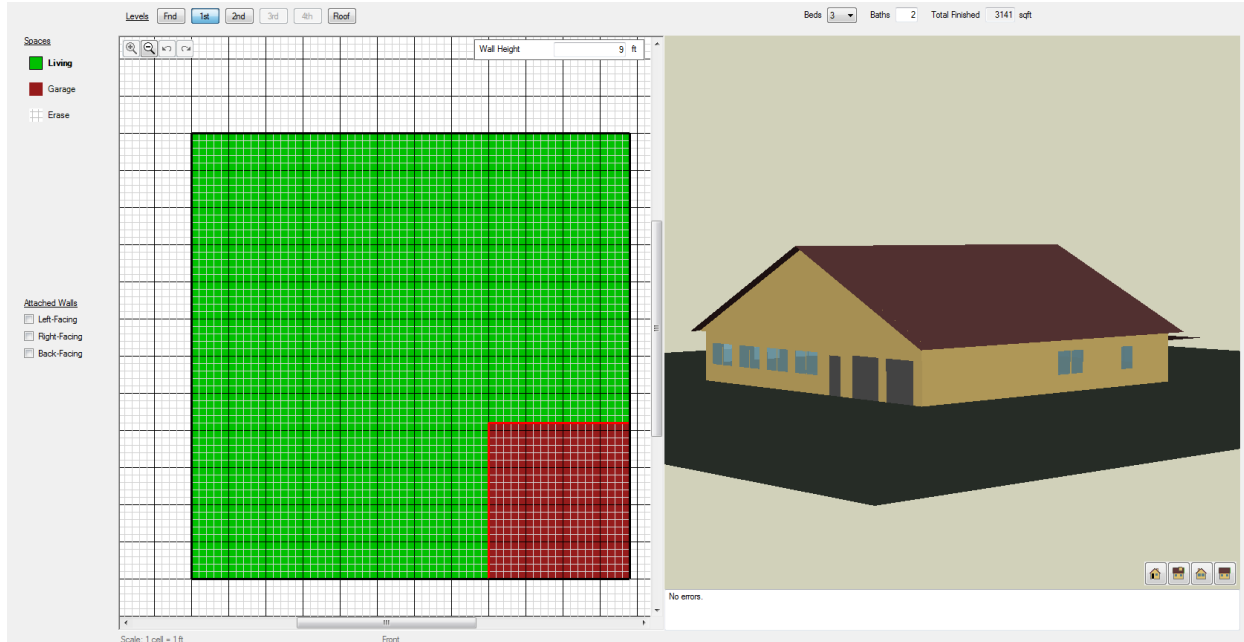

Figure 11. Austin home model in BEopt.

Once geometries were constructed, BEopt allows for selection of a number of inputs including orientation, building envelope characteristics, HVAC systems and efficiencies, heating and cooling set points, thermal mass characteristics, and several other parameters that govern energy performance in the homes. Each input was adjusted in BEopt to best reflect input values in Table 1. All inputs related to occupant activity, such as natural ventilation (i.e., window opening) during mild weather and appliance, lighting, and miscellaneous load profiles, were chosen as the default values in BEopt, which relies on the well-established inputs in the Building America House Simulation Protocols (Hendron and Engebrecht, 2010).

Once all available inputs were selected in BEopt, a simulation was run in order to generate an EnergyPlus input (IDF) file. The IDF file was copied for each home and the results of the initial simulation were discarded. The IDF file was then edited using a combination of the EnergyPlus IDF Editor and a simple text editor to vary inputs to reflect each simulation case. Rated airflow rates for HVAC equipment and duct sizes were kept at the maximum (nominal) value for each simulation case, but the design and specified airflow rates were adjusted in each case (and capacities were adjusted internally within EnergyPlus using built-in algorithms). Airflow rates were changed in each of the `AirLoopHVAC:UnitaryHeatCool`, `Fan:OnOff`, `AirTerminal:SingleDuct:Uncontrolled`, and `Branch` sections of the IDF file. Fan pressure and efficiency were also changed for each case (in the `Fan:OnOff` section of the IDF file), which governs fan power draw in the simulations. Finally, duct UA values were adjusted for each case in a separate section of the IDF file that is created by BEopt (`EnergyManagementSystem:Program`). This involved changing approximately 8-10 inputs per simulation case.

No dedicated outdoor air supply or heat recovery was used in either home. Thermostat set points were 76°F in the summer and 70°F in the winter. Internal electric loads included a dishwasher, refrigerator, clothes washer, lighting, and miscellaneous; all schedules were taken directly from

default values in BEopt. Duct leakage fractions remained the same in each scenario (10% of air handler flow). All of the EnergyPlus input files are stored in an online repository available for free download (Stephens, 2014).

Important EnergyPlus outputs for the Chicago home included annual electric use for the AHU fan and outdoor condenser-compressor unit, as well as annual natural gas usage for the furnace. Similar annual outputs for the Austin home included electric use for the AHU fan and heat pump during both heating and cooling (recorded separately). These annual outputs were first used to explore impacts of fans and duct design on space conditioning energy use and costs on an annual basis using baseline energy cost estimates. In this work, “cooling energy” refers to the energy used by the compressor during cooling modes; “heating energy” refers to energy used by either the furnace (Chicago) or the heat pump (Austin) during heating modes; “fan energy” refers to the total amount of energy used by the AHU fan during either heating or cooling modes; and “HVAC energy” refers to the combination of fan + compressor + furnace energy usage. The same results were also used to explore life cycle costs, using methods described below.

Task 5. Life cycle cost estimation and optimization

Estimates of annual energy consumption from Task 4 were first summed over an assumed 15-year lifetime of the units to determine the estimated total lifetime energy consumption of each configuration. A 15-year lifetime was chosen as the primary life cycle length because although ductwork will typically last much longer, the actual systems modeled herein (and all of their associated capacity and efficiency inputs) are likely to be replaced within 15 years. Thus, it is actually most appropriate to consider the lifetime of the systems on which all of the input parameters are based. However, we also consider a 30-year lifespan to explore any potential differences in life cycle cost-benefit ratios or payback periods that may be introduced by using a longer timeframe. The 30-year lifespan however does not include equipment replacement costs because the efficiency and capital costs of equipment available 15 years from now are unknown.

To make the simulation outputs as nationally representative as possible, national average residential electricity rates and natural gas costs were explored to inform the energy cost assumptions. Also, the same electricity and natural gas rates were used in each simulation location; local and regional impacts were not explored. Figure 12 shows historical U.S. average residential natural gas rates over the past ~40 years using data from the US EIA (U.S. residential natural gas costs culled from <http://www.eia.gov/dnav/ng/hist/n3010us3a.htm>). Natural gas costs were simply assumed to remain constant at the 10-year average of \$11.90 per 1000 cubic feet, primarily because of recent decreases in gas costs that disrupt any clear trend in costs and because of historical difficulty in accurately forecasting natural gas prices (Sanders et al., 2008). Natural gas volumetric costs translate to approximately 1.16 cents per 1000 BTU or \$11.6 per million BTU. Baseline electricity costs are assumed to be 11.8 cents per kWh in the present year (U.S. residential electricity rates culled from <http://www.eia.gov/electricity/state/pdf/sep2010.pdf> and http://www.eia.gov/energyexplained/index.cfm?page=electricity_factors_affecting_prices). Nominal electricity costs were assumed to increase at an annual nominal rate of 2.0%, or a real rate of 0.3% in 2011 dollars (EIA, 2013).

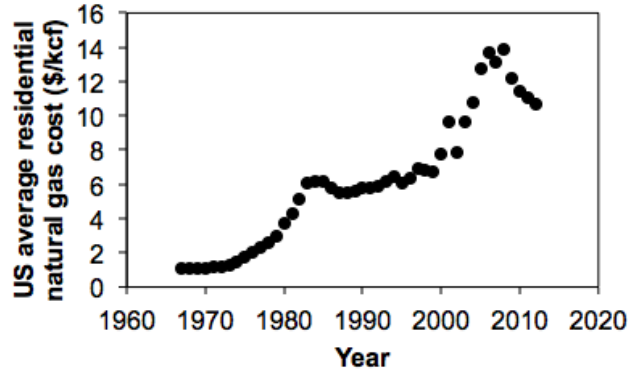

Figure 12. Historical U.S. national average residential natural gas costs

Net present value (NPV). To explore the upfront costs and life cycle operational benefits of each duct design scenario, we first compared differences in upfront costs between each duct design to differences in cumulative energy costs summed over 15 years of life, accounting for both increases in electricity costs and inflation. This allows for a comparison between the excess costs of a design to any added benefit (in terms of operational energy cost savings) or added cost (in terms of additional operational energy costs required) over the assumed lifespan of 15 years. The typically lowest cost, highest pressure (i.e., 1.10” or 1.15”) ductwork design was first used as the reference case for other scenarios to compare to, treating rigid and flex ductwork materials separately. However, the analysis was performed separately for PSC and ECM blowers because we have not captured differences in initial costs for these fan types. An additional comparison was also made across both flex and metal ductwork to capture the costs and benefits of using different pressure ductwork designs with different materials, although this analysis is somewhat limited as described in a later section.

The cost-benefit analysis results from above were also converted into a net present value (NPV) as the primary way to compare life cycle costs and benefits associated with investment in the various ductwork designs. The annual NPV was estimated for each scenario according to Equation 4, which follows a procedure outlined in the 2012 Supplement to NIST Handbook 135 *Life-Cycle Costing Manual for the Federal Energy Management Program* (Rushing et al., 2012).

$$NPV_n = \frac{\Delta C_n}{(1+d)^n} \quad (4)$$

where ΔC_n = the difference in annual energy cost for heating and cooling between a particular duct design configuration and the baseline configuration in year n ; d = the discount rate (assumed 3.5% based on a 3.0% real rate excluding inflation and a 0.5% long-term average inflation rate, as described in the 2012 Supplement to NIST Handbook 135, Rushing et al., 2012); and n = the year of analysis. The total NPV over the course of a 15-year life cycle was then estimated according to Equation 5.

$$NPV_{lifecycle} = \sum_{n=0}^{15} NPV_n \quad (5)$$

where $NPV_{lifecycle}$ is simply the sum of the NPV_n for each of the 15 assumed years of the design life cycle, including the cost of implementation of ductwork in year 0. This yields the total NPV, which can be used to evaluate whether or not an investment will be beneficial or costly over its lifetime compared to a reference scenario. In this work, a positive total NPV describes an investment in which benefits exceed costs (i.e., positive NPV = savings). Conversely, a negative total NPV describes an investment in which costs exceed benefits over the duration of the design life cycle (i.e., negative NPV = excess costs).

Finally, results from Task 4 and Task 5 were used to identify the lowest life cycle cost duct design and fan combinations in the two simulated homes. These configurations were identified by the scenarios with the highest NPVs and some reasons are given as to why they may have achieved the lowest life cycle costs (or more appropriately, greatest life cycle benefits).

Task 6. Sensitivity analysis

There are a variety of input parameters that may greatly influence the modeling results and cost analyses herein, including: changes in assumptions for future energy costs, duct leakage fractions, ductwork insulation values, thermostat settings, envelope thermal performance, HVAC equipment efficiency (i.e., SEER for both air-conditioning units, AFUE for the furnace, and HSPF for the heat pump), and the location of the ductwork (i.e., moving inside to conditioned space). However, it was beyond the scope of this project to systematically vary each parameter individually as would be appropriate for a large suite of Monte Carlo simulations. Additionally, several of these parameters are fixed for new homes according to code minimums and are not likely to vary much in the modeled homes (particularly not in a direction that would lead to greater energy impacts than the results modeled herein). Ultimately, we provide a quantitative exploration of the influence of only one particular set of parameters on the results: lower HVAC equipment efficiency, which was chosen because it is a realistic variation that would create greater disparities in absolute energy savings and costs (and thus have a large, realistic influence on the final outcomes of this work). Finally, the same cost analysis approach was also used assuming a 30-year lifespan to test the sensitivity of the results to assumptions for ductwork life.

Results

Results from the simulations and analyses herein are described in the following order:

1. Initial costs of each ductwork design
2. Baseline space heating and cooling energy consumption and costs from annual energy simulations of each configuration
3. Life cycle cost-benefit ratios and net present values
4. Exploration of optimal (minimum) life cycle costs and sensitivity analyses

Initial costs of duct designs

Table 8 describes initial design and installation cost estimates for each duct design in each home from both contractors. The contractors provided initial costs that included HVAC equipment as well. However, HVAC equipment costs (which were the same for each contractor’s estimate for each scenario) were subtracted out of the total costs to provide only the cost estimates for ductwork design and installation.

Table 8. Duct design and installation cost estimates from the hired contractors

Duct material	Duct pressure	Total external static pressure	Initial design and installation cost	
			Chicago contractor	Austin contractor
			Chicago home	
Flex duct	0.15”	0.50”	\$4,970	\$3,784
	0.45”	0.80”	\$4,870	\$3,665
	0.75”	1.10”	\$4,820	\$3,903
Sheet metal	0.15”	0.50”	\$10,470	\$7,370
	0.45”	0.80”	\$8,970	\$7,423
	0.75”	1.10”	\$8,820	\$7,361
			Austin home	
Flex duct	0.20”	0.55”	\$6,110	\$4,182
	0.50”	0.85”	\$5,360	\$4,160
	0.80”	1.15”	\$4,860	\$4,114
Sheet metal	0.20”	0.55”	\$11,410	\$7,324
	0.50”	0.85”	\$10,910	\$7,160
	0.80”	1.15”	\$10,510	\$7,132

Chicago contractor cost estimates. For both the Austin and Chicago home duct designs by the Chicago contractor, lower pressure ducts would consistently be more expensive than higher pressure ducts. For example, the lowest pressure flex duct would cost approximately \$150 more than the highest pressure flex duct (~3% higher) in the Chicago home; the same comparison yields an excess cost of \$1250 in the Austin home (~26% higher costs). Similarly, the lowest pressure sheet metal duct is estimated to cost \$1650 more than the highest pressure metal duct (~19% higher) in the Chicago home and \$900 more (~8% higher) in the Austin home. These differences are attributed to both differences in ductwork material (between flex and rigid) and to the diameters of ductwork runs. These differences were largely expected based on material impacts alone.

Austin contractor cost estimates. For both the Austin and Chicago home duct designs by the Austin contractor, differences between lower pressure and higher pressure duct costs were not as straightforward, which was not expected. For example, the lowest pressure flex duct would cost approximately \$119 *less* than the highest pressure flex duct in the Chicago home; the same comparison yields an excess cost of only \$68 in the Austin home. Sometimes the medium pressure duct design had the highest cost. Similarly, the lowest pressure sheet metal duct is estimated to cost only \$9 more than the highest pressure metal duct in the Chicago home and only \$192 more in the Austin home. These differences are attributed to a combination of differences in ductwork material (between flex and rigid), the design diameters of ductwork runs, and the labor requirements for installation. Obviously the two contractors delivered very different designs and cost estimates to meet the same goals, which is important to capture in the analysis herein. This provides an important limitation as well and suggests that because these costs may not be generally representative of all contractors' designs, results should be interpreted with caution.

Comparing contractor estimates. On absolute terms, duct design and installation was estimated to cost less for the smaller Chicago home, which is intuitive for the amount of materials involved in the smaller home. This was true for both contractors. Also, for both contractors, rigid sheet metal ductwork was estimated to cost substantially more than flex duct for all scenarios, as much as ~\$6000 more for some configurations. This large excess initial cost was due not only to differences in materials but in estimates of the more intensive level of labor required to install rigid ductwork relative to flexible ductwork. Finally, it is important to note that the design and installation estimates from the Austin contractor were consistently lower for all configurations, reflecting a combination of differences in labor and total material costs between the two contractors and their respective locations.

These estimates provide the starting point for differences in installation costs to which differences in annual energy savings (or excess costs) are compared to for each configuration.

Annual energy simulation results

This section shows results from the annual energy simulations for each configuration, beginning with the Chicago and Austin homes with the Chicago contractor’s duct designs. A full table of results from the simulations for both homes and their duct designs performed by the Chicago contractor are shown in Table 9.

Chicago Home: Chicago contractor designs

The simulated annual HVAC energy use and associated costs (in the baseline year 1) based on the Chicago contractor’s duct designs for the Chicago home are shown in Figure 13. The first row shows results for flex duct designs and the second row shows results for rigid sheet metal designs. Each plot is split by PSC and ECM blowers and shows each of the design duct pressures (low, medium, and high). The first column shows annual estimated fan and cooling electricity use (in kWh). The second column shows annual natural gas use for space heating (in million BTU). The third column shows baseline (1st year) space conditioning energy costs (at today’s rates) split by heating energy, fan energy, and cooling energy. Other non-HVAC energy consumption is ignored in this analysis because they are unaffected by the input variables used herein, although it should be noted that heating energy accounted for ~73% of the total amount of predicted natural gas usage in the Chicago home, on average, while fan and cooling energy accounted for only ~8% and ~6% of total electricity usage across the scenarios, respectively. Baseline annual energy costs are estimated using an electricity rate of 11.8 cents per kWh and \$11.6 per million BTU for natural gas.

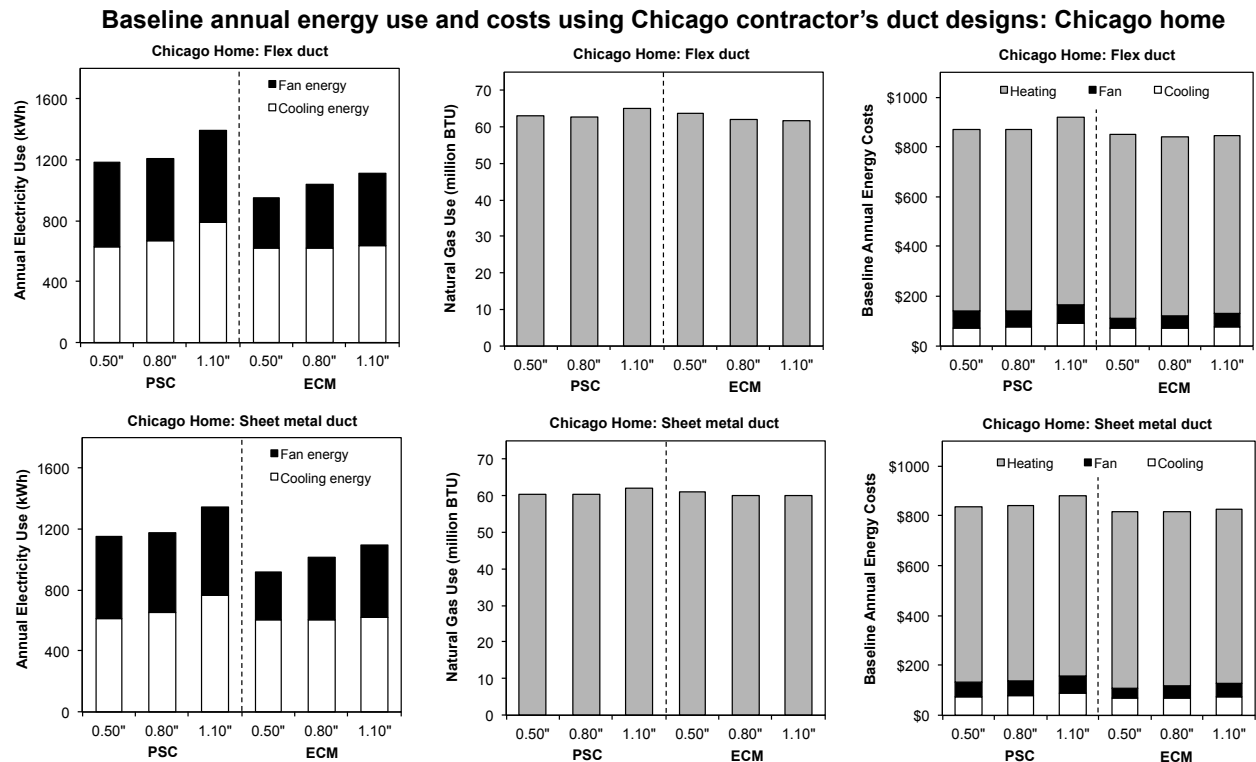

Figure 13. Estimated annual fan, cooling, and heating energy usage and total HVAC energy costs for the Chicago home (at baseline energy costs) with both types of AHU fans and both rigid and flex duct work at each duct design (using only the Chicago contractor’s duct designs).

The relative comparison of annual (i) heating energy, (ii) fan energy, (iii) cooling energy, and (iv) total HVAC energy costs between each of the three static pressures for each duct system and fan type for the Chicago home as designed by the Chicago contractor is shown in Figure 14.

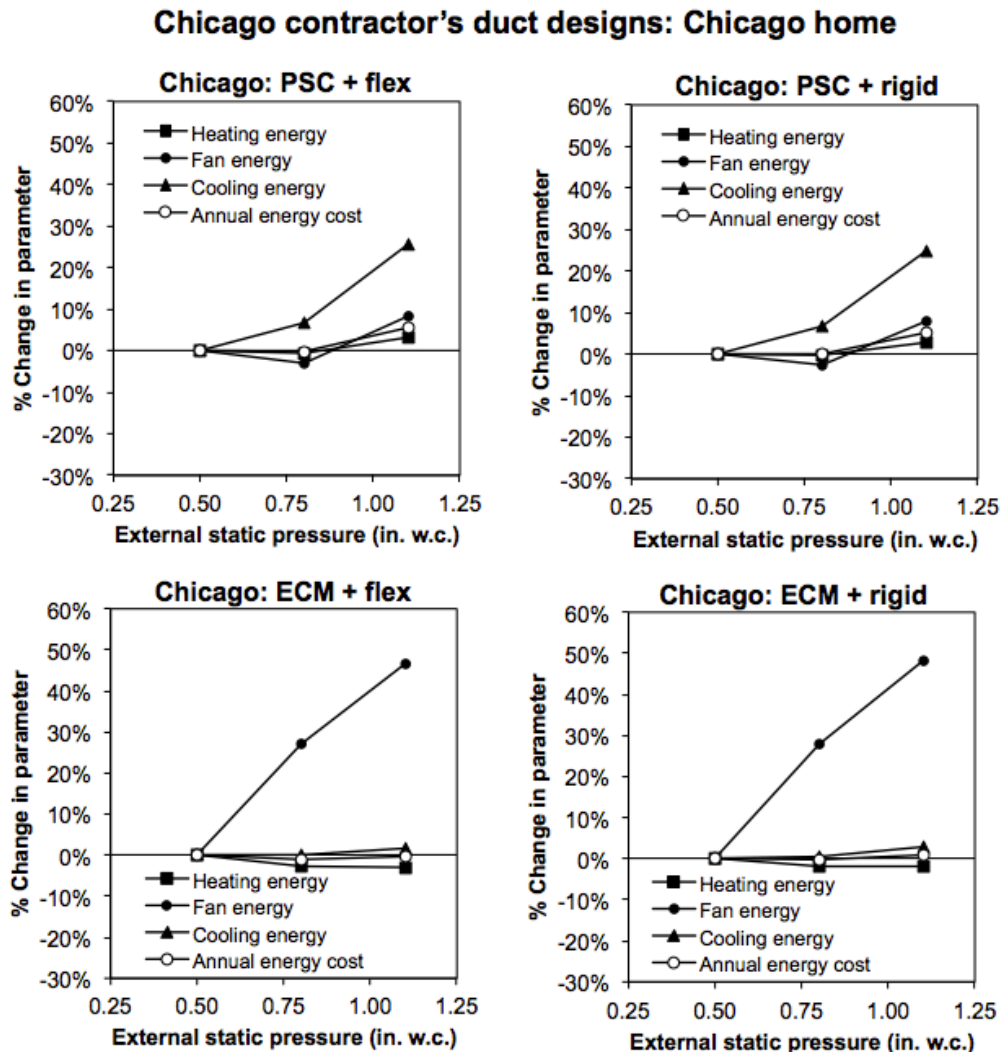

Figure 14. Estimated relative change in annual fan, cooling, and heating energy usage and total annual HVAC energy costs for the Chicago home with both types of AHU fans and both rigid and flex duct work at each duct design (using only the Chicago contractor's duct designs).

Relative differences among design duct pressures were similar among rigid and flex ductwork in the Chicago home. For PSC blowers and both ductwork types, cooling energy increased by approximately 7% when moving from 0.50" to 0.80" and increased approximately 26% when moving from 0.50" to 1.10". Both reflect increases in system runtimes at airflow rates that are 20% and 48% lower, respectively. Lower airflow rates led to lower cooling capacities at these higher pressures, although the increase in runtime was not as large as decreased airflow rates for a number of reasons, including nonlinear reductions in sensible capacity, reduced compressor power draw at the lower airflow rates, less reject heat added to the airstream for the PSC blowers, and lower conductive losses through ductwork with lower surface areas and lower UA values.

An additional set of simulations was also run assuming that each of the cases had the same duct UA values, which was used to verify the maximum increases in system runtimes and overall cooling energy use. In this case, cooling energy increased approximately 9% at the 0.80" pressure and 31% at the 1.10" pressure, suggestions that lower ductwork surface areas with the Chicago contractor's designs contribute a relatively small amount to the overall predicted changes in energy use. These results are similar to those simulated in other studies (e.g., Nassif, 2012) and suggest that (i) EnergyPlus can successfully simulate these complex relationships between power draw, airflow, capacity, and system runtime reasonably well, and (ii) the relationship between airflow reductions and increases in system runtime and cooling energy use is indeed nonlinear in the modeled home. For example, a 20% reduction in airflow yielded a 9% increase in cooling energy use and a 48% reduction in airflow yielded a 31% increase in cooling energy use, both after accounting for the combined effects of reduced cooling capacity, less reject heat to the airstream, and lower compressor power draw. These values are much more in line with likely decreases in sensible capacity of 10% and 29%, respectively, from Table 6.

Turning back to actual scenario results with proper inputs from Table 5, annual fan energy did not change when moving to 0.80", but increased by 14% when moving to 1.10" for the PSC+flex system, suggesting that any reductions in fan power draw observed at moderately increased static pressures were negated by longer system runtimes. This is especially true at the more extreme 1.10" static pressure condition with PSC blowers. Similar changes of -1% and +11% were also predicted for the PSC+rigid system.

For the ECM+flex system, there were only small increases in cooling energy consumption of 0% and +2% at 0.80" and 1.10" relative to 0.50", which is generally appropriate for a very small (or negligible) change in airflow rates and cooling capacities (from Table 5). The slight increase in cooling energy at the highest pressure may be explained by an increase in heat rejected into the airstream by the ECM blower using more power. Again setting duct UA values equal, cooling energy increased 2% and 4% at the 0.80" and 1.10" pressures with the ECM+flex system, suggesting that lower duct UA values in the actual contractor's scenarios served to offset some of the excess reject heat from the AHU fans.

Correspondingly for the ECM+flex combinations, there was a 27% and 47% increase in fan energy consumption for the two higher pressures, respectively, due primarily to greater power draw of the ECM blowers at higher pressures. There was also a 3% reduction in heating energy at both of these two higher pressures, likely due to the combination of increased reject heat from the fans as they drew more power at the higher pressures, as well as a small reduction in conductive losses through lower UA ducts. Similarly for the ECM+rigid system, cooling energy increased 0% and 3% at 0.80" and 1.10" relative to 0.50"; fan energy increased 28% and 48%, and heating energy decreased 2% at each of the same pressures.

Although some of these changes appear large, these results suggest that the overall change in annual heating and cooling energy use at either of the higher pressures in the Chicago home was relatively small, particularly at the medium pressure. This is largely because there were only minor changes (3% or less for all cases) in annual heating energy and Chicago is a largely heating dominated climate. Cooling energy and fan energy increased by as much as 26% and 48%, respectively, but the combination of cooling and fan energy is never more than

approximately 17% of the total electricity consumption in this home. Overall, total HVAC energy costs in the baseline year were estimated to be ~0.2% lower and ~5% higher for each of the flex or rigid PSC scenarios when comparing 0.80" and 1.10" systems to 0.50" systems, respectively. The impact on ECM scenarios was even smaller: total HVAC energy costs were 0.2-1% lower for 0.80" systems and between 0.3% lower (flex) and 0.8% higher (rigid) in the 1.10" systems, respectively, compared to the 0.50" systems. Therefore, these results suggest that in this particular home in this climate with these particular duct designs and under the aforementioned assumptions, the combined effects of higher duct pressures on airflow rates, fan power draws, system capacities, and outdoor unit power draws can have a small negative impact on total system runtime and energy consumption in these systems with PSC blowers and a negligible impact in these systems with ECM blowers. A few scenarios even showed slight savings associated with moderately higher pressures, although the magnitudes were very small.

There is some recent evidence from other simulations that these small changes in energy consumption are reasonable estimates for the input parameters explored herein. For example, Walker et al. (2012) estimated that higher efficiency, higher pressure drop filters that decreased airflow rates in PSC systems by ~27% compared to baseline would lead to a ~1% increase in energy consumption on average across several climate zones in California. BPM/ECM blowers were estimated to use 1-3% more energy across the same homes and climates due to additional fan energy required to overcome the greater pressure drop. In heating dominated climates in California, most of their higher pressure, lower airflow PSC simulations actually resulted in slight reductions in annual energy consumption, similar to our results for moderate pressures (0.80") in the Chicago PSC home modeled herein.

In another recent study, Wilson et al. (2013) estimated that a 30% reduction in airflow rates in residential PSC systems would lead to up to 5% excess cooling energy use in cooling-dominated climates or 7-9% excess heating energy use in heating-dominated climates, although only for very poorly insulated duct systems installed in unconditioned spaces. If ducts are moderately insulated or installed in conditioned spaces, they predicted smaller increases in heating and cooling energy use at lower airflow rates in the same PSC systems.

PSC vs. ECM: Chicago home. In the Chicago home simulations using the Chicago contractor's duct designs, total HVAC energy costs were consistently lower for ECM blowers than for PSC blowers. For example, cooling energy was 10% lower using ECM blowers with both types of ductwork; fan energy was 27-28% lower; space heating was 1-2% lower; and total HVAC energy costs were 4% lower when comparing between ECM and PSC blowers with similar ductwork types and averaged over all design pressures. These results suggest that in this home under these assumptions, ECM blowers can save a small amount of energy annually (up to ~4% of annual energy costs) relative to the use of PSC blowers, regardless of duct design.

Rigid vs. flex ductwork materials: Chicago home. Rigid metal ductwork, which had a lower UA than flex duct at all pressures because of shorter, less complicated duct runs designed by the Chicago contractor, generally led to lower energy use for cooling, fans, and heating, although the magnitude of differences varied by use. For example, the mean requirements for heating energy were 3-4% lower for rigid versus flex ducts; fan energy was 2-4% lower for rigid ducts; cooling energy was 2-3% lower for rigid ducts; and total annual HVAC energy costs were ~3-4% lower

for rigid ducts than for flexible ductwork. Lower fan energy was not driven by differences in fan power (which are constant inputs for each pressure regardless of duct system), but by changes in system runtime during both heating and cooling operating, which in turn are primarily driven by differences in heat transfer losses across the different surface areas of R-6 ductwork installed in the unconditioned basement. AHU fan runtimes during both heating and cooling periods are shown in Figure 21 for all modeled scenarios.

Overall, these results suggest that the lowest pressure ductwork designs by this contractor for this particular home would be expected to decrease annual energy costs for space conditioning by as much as ~5% compared to the highest pressure ductwork design if the system utilizes a PSC blower. Conversely, if an ECM blower is utilized, these lower pressure ductwork designs are predicted to have a very small impact of total HVAC energy costs (less than 1% in most cases and sometimes in the direction of slight savings). Additionally, the use of ECM blowers alone (rather than PSC blowers) or rigid ductwork alone (rather than flex ductwork) could save up to 4% on annual energy costs if implemented individually, regardless of ductwork pressure, suggesting that greater emphasis perhaps should be placed on upgrading to modern AHU blowers or lowering duct UA values regardless of duct pressure. However, we should reemphasize that these results are limited to the particular designs by the Chicago contractor mentioned herein.

Austin Home: Chicago contractor designs

Baseline annual HVAC energy use and costs based on the Chicago contractor's duct designs for the Austin home are shown in Figure 15 in a format similar to the previous figures. The first row shows results for flex duct designs and the second row shows results for rigid sheet metal designs. Each plot is split by PSC and ECM blowers and shows each of the design duct pressures (low, medium, and high). The first column shows annual estimated fan, heating, and cooling electricity use (in kWh). The second column shows baseline (1st year) space conditioning energy costs (at current costs) split by heating energy, fan energy, and cooling energy. Other non-HVAC energy uses are ignored in this portion of the analysis because they are unaffected by the input variables used herein, although it should be noted that space conditioning energy use accounted for only 36-47% of the total amount of predicted electricity usage in the Austin home, depending on configuration. Baseline annual energy costs are estimated using the same electricity rate of 11.8 cents per kWh (this home does not use natural gas for space conditioning).

The relative comparison between each of the three static pressures for each duct system and fan type for the Austin home as designed by the Chicago contractor is also shown in Figure 16.

Baseline annual energy use and costs using Chicago contractor's duct designs: Austin home

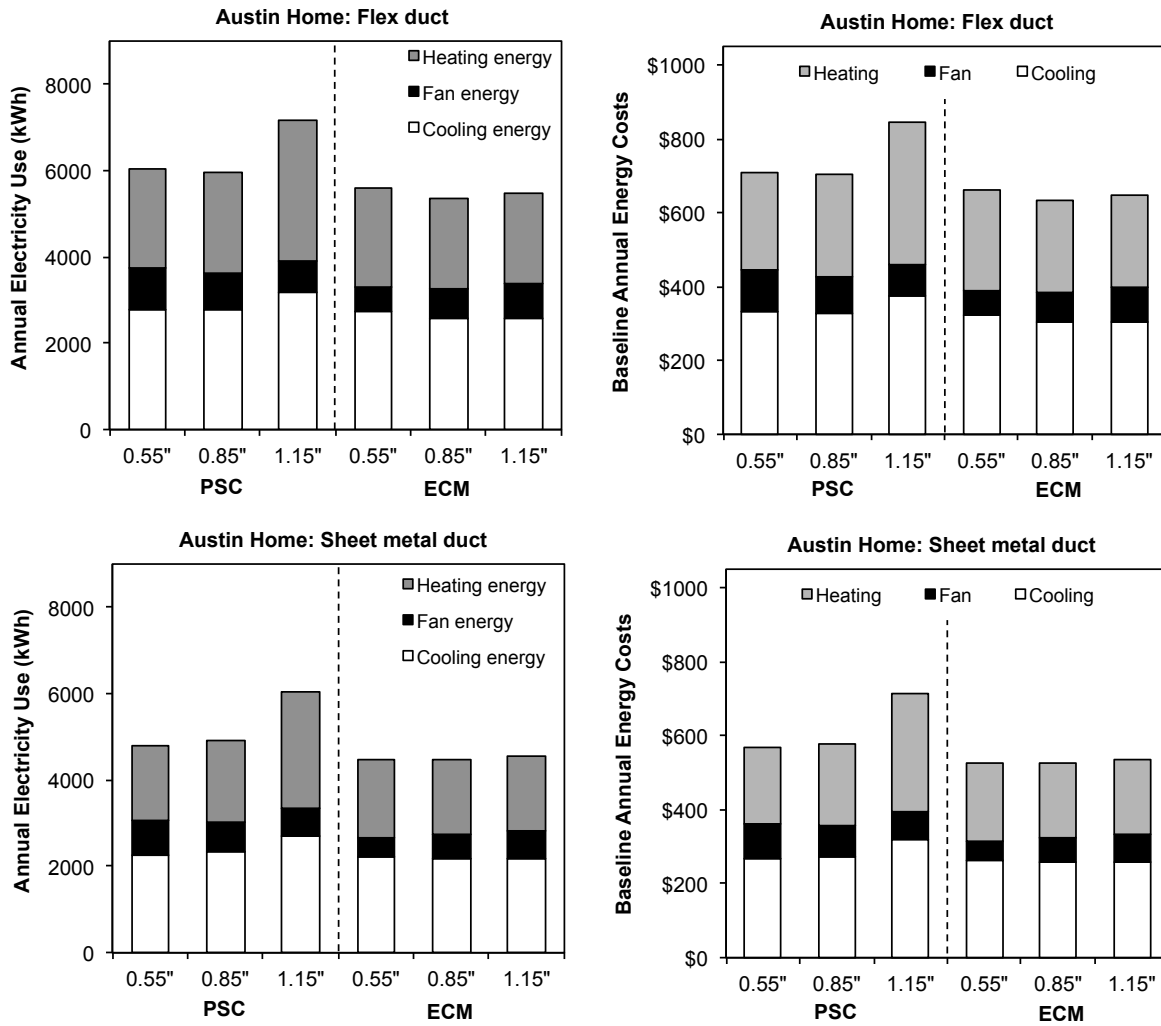

Figure 15. Estimated annual fan, cooling, and heating energy usage and total HVAC costs for the Austin home (at baseline energy costs) with both types of AHU fans and both rigid and flex duct work at each duct design (using only the Chicago contractor's duct designs).

Chicago contractor's duct designs: Austin home

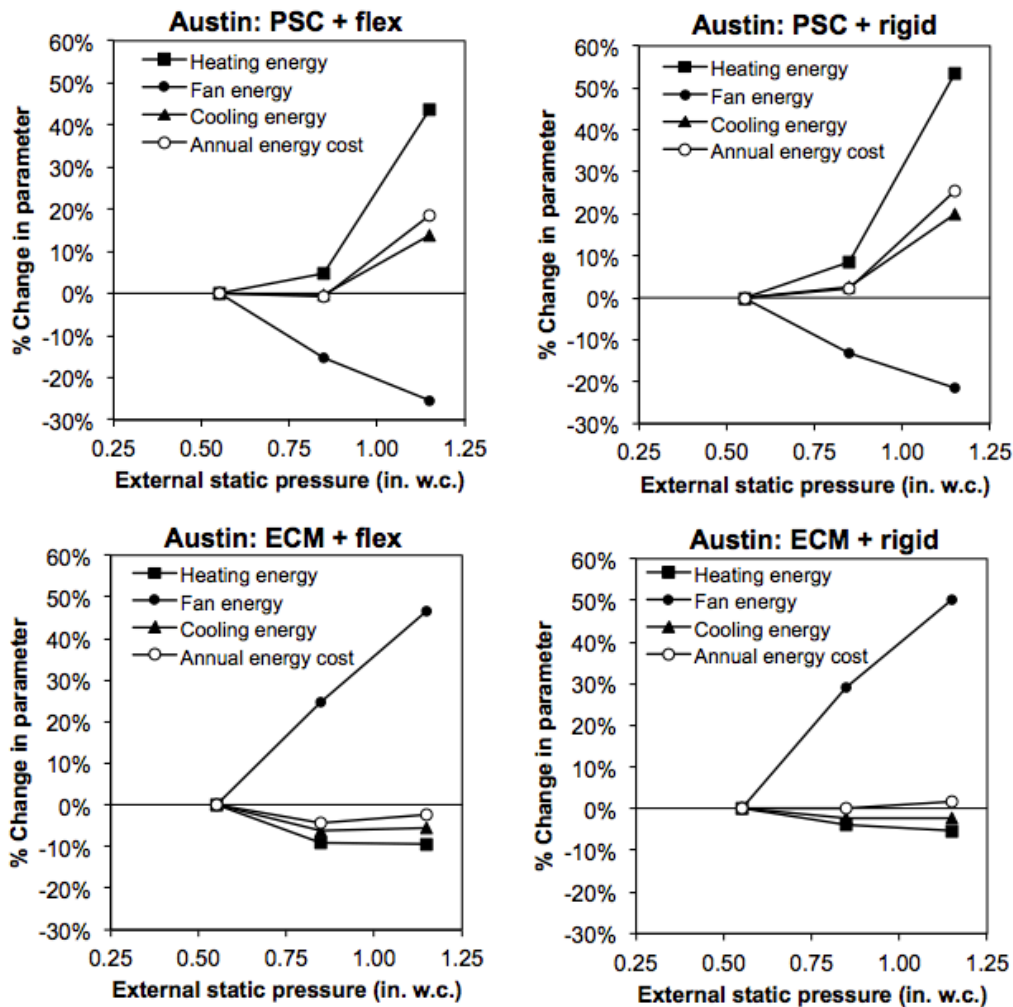

Figure 16. Estimated relative change in annual fan, cooling, and heating energy usage and total annual HVAC energy costs for the Austin home with both types of AHU fans and both rigid and flex duct work at each duct design (using only the Chicago contractor's duct designs).

In the Austin home with PSC blowers and flexible ductwork materials, cooling energy slightly decreased by 0.3% when moving from 0.55” to 0.85” and increased by 14% when moving from 0.55” to 1.15”. Impacts were greater in magnitude for the PSC+rigid combinations: cooling energy increased 3% at 0.85” and increased 20% at 1.15”, suggesting that higher duct UA values in the flex systems with the Chicago contractor’s designs masked some of the fan and flow impacts in the Austin home. Again, increases in cooling energy were due to a combination of longer system runtimes mitigated in part by a lower fan power draw (which rejects less heat into the airstream), lower compressor power draw, and reduced heat transfer across ductwork surfaces at the higher pressure designs.

Annual fan energy actually decreased 15% and 25% when moving to 0.85” and 1.15”, respectively, for the PSC+flex system, suggesting an increase in static pressure may actually provide a benefit in terms of fan energy because of reduced airflow rates and fan power draw

requirements (and that these impacts were not offset by longer system runtimes in this home). For the PSC+rigid system, annual fan energy decreased 13% and 22% at 0.85" and 1.15" relative to 0.55". Heating energy consumption increased approximately 5% for the 0.85" PSC+flex system and 43% for the 1.15" system, suggesting that lower airflow rates have a large impact on heat pump performance and runtime in this home with these duct designs. Results were similar in the PSC+rigid systems: heating energy increased 9% at 0.85" and 54% at 1.15".

For the ECM+flex system, there was a 6% change in cooling energy consumption at both 0.80" and 1.10", which captures the combined effects of excess heat rejected to the airstream by the AHU blowers drawing more power at greater pressures offset some by lower duct UA values from the Chicago contractor's designs. In fact, fan energy increased by 25% and 46% for the medium and high pressure ECM+flex designs, respectively. There was also a 9% reduction in heating energy at both of these higher pressures, most likely due to the combined effects of reduced heat transfer across the lower UA ductwork designs in the unconditioned attic and the addition of excess reject heat from the fans drawing higher power at higher pressures.

Similarly for the ECM+rigid system, cooling energy decreased by 2% at both 0.85" and 1.15" relative to 0.55"; fan energy increased 29% and 50%; and heating energy decreased 4% and 5% at each of the same pressures.

Overall, these results suggest that the total change in annual heating and cooling energy use and thus annual energy costs at either of the higher pressures in the Austin home is largely a function of the type of fan utilized. For example, total HVAC energy costs (fan + cooling + heating combined) were 1% lower and 19% higher for the medium and high pressure PSC+flex combinations compared to their low pressure counterparts, respectively, and 2% and 25% higher for the medium and high pressure PSC+rigid combinations. Therefore, the lowest pressure duct designs in this home with a PSC fan could lead to substantial reductions in energy costs (as much as 25%) relative to those encountered using the highest pressure duct designs. Moderate pressure designs had a much smaller impact.

Conversely, for the ECM+flex combination, the medium and high pressure duct systems led to a 4% and 2% *decrease* in total HVAC energy costs, respectively, due largely to reduced heating energy requirements with lower duct UA values. For the ECM+rigid combination, the medium pressure duct system led to a negligible change in total HVAC energy costs while the high pressure duct system led to a 2% increase. Therefore, these particular lower pressure duct designs in this home with an ECM blower would either increase or decrease space conditioning costs depending on the surface area (or level of insulation) of ductwork, although the magnitude of changes was never predicted to be larger than 4%.

For comparison, Walker et al. (2012) estimated that higher efficiency, higher pressure drop filters that decreased airflow rates in PSC systems compared to baseline would lead to anywhere between a 1% savings to 3% increase in space conditioning energy in a cooling-dominated climate in California, depending on the extent of flow reductions. Our results show more drastic impacts at the lowest airflow rates used herein. Conversely, all higher pressure ECM/BPM scenarios were estimated in Walker et al. (2012) to use more energy for space conditioning (as

much as 5% more energy for a system with a high pressure drop MERV 16 filter installed and minimal duct leakage), which is within the same order of magnitude of changes observed herein.

Overall, the Austin home results suggest that in this home in this climate with these duct designs by the Chicago contractor and under the aforementioned assumptions, the combined effects of lower duct pressures will likely decrease space conditioning costs as much as 25% with a PSC blower installed (compared to the highest pressure duct design), but could either slightly increase (as much as +2%) or decrease (as much as -4%) space conditioning costs with an ECM blower installed.

PSC vs. ECM: Austin home. In the Austin home simulations (using the Chicago contractor's duct designs), total HVAC energy costs also varied between ECM and PSC blowers. For example, total HVAC energy costs were 14-15% lower for ECM blowers versus PSC blowers with either type of ductwork due to the combined effects of a 10% decrease in cooling energy, a 20% reduction in fan energy, and a 17-18% decrease in heating energy. It appears that fan power and efficiency both drive the majority of the savings.

Rigid vs. flex ductwork materials: Austin home. Metal ductwork, which had a lower UA than flex duct at all pressures, also led to lower energy usage and costs for space conditioning in the Austin home overall using the Chicago contractor's designs. For example, the mean requirements for cooling energy were ~17% lower for rigid versus flex ducts with either fan type; fan energy required was ~16% lower; and space heating energy was 19-20% lower for rigid ducts. Total annual HVAC energy costs were ~18% lower for rigid ducts compared to flex for both fan types. These results suggest that large savings are achievable by lower UA values for the rigid ducts installed in the unconditioned attic, driven by surface areas that were approximately 50% lower due on average due to fewer duct branches in the designs.

The full results from all of these simulations using the Chicago contractor's designs are shown in Table 9.

Table 9. Annual energy simulation results for both homes at baseline using the Chicago contractor’s designs

Home	Duct type	Blower	Total Pressure (in. w.c.)	Airflow rate (CFM)	Cooling (kWh)	AHU Fans (kWh)	Total Electricity (kWh)	Heating ($\times 10^6$ Btu)	Total Gas Consumption ($\times 10^6$ Btu)
Chicago 3-ton AC Gas furnace 1200 CFM nominal	Flex	PSC	0.50"	1200	631	556	8131	62.98	86.21
			0.80"	964	672	539	8156	62.61	85.84
			1.10"	622	792	603	8342	64.92	88.09
		ECM	0.50"	1200	622	328	7895	63.60	86.82
			0.80"	1162	622	417	7983	61.93	85.20
			1.10"	1103	633	481	8058	61.71	84.98
	Metal	PSC	0.50"	1200	614	536	8095	60.51	83.81
			0.80"	964	656	522	8122	60.38	83.67
			1.10"	622	767	578	8289	62.20	85.44
		ECM	0.50"	1200	606	317	7867	61.10	84.39
			0.80"	1162	608	406	7958	60.01	83.32
			1.10"	1103	622	469	8036	59.96	83.28
			Total Pressure (in. w.c.)	Airflow rate (CFM)	Cooling (kWh)	AHU Fans (kWh)	Heating Electricity (kWh)	Total HVAC Electricity (kWh)	Total Electricity (kWh)
Austin 4-ton heat pump 1600 CFM nominal	Flex	PSC	0.55"	1600	2797	964	2261	6022	14008
			0.85"	1316	2789	817	2369	5975	13961
			1.15"	916	3183	719	3244	7147	15133
		ECM	0.55"	1600	2747	539	2311	5597	13583
			0.85"	1590	2578	672	2100	5350	13336
			1.15"	1566	2594	789	2094	5478	13464
	Metal	PSC	0.55"	1600	2267	786	1756	4808	12797
			0.85"	1316	2325	683	1906	4914	12900
			1.15"	916	2717	617	2697	6031	14017
		ECM	0.55"	1600	2231	442	1789	4461	12447
			0.85"	1590	2183	569	1717	4469	12458
			1.15"	1566	2178	664	1694	4536	12525

Chicago Home: Austin contractor designs

The simulated annual HVAC energy use and associated costs in the baseline year for the duct designs by the Austin contractor are now presented, first for the Chicago home and second for the Austin home. Results are presented in the same manner as the previous results for the Chicago contractor’s designs. Annual HVAC energy use and costs are first shown in Figure 17. Relative differences are then shown in Figure 18. Other non-HVAC energy consumption is again ignored in this portion of the analysis, although it should be noted that heating energy accounted for 68-69% of the total amount of predicted natural gas usage in the Chicago home, on average, while fan and cooling energy accounted for ~8% and ~6% of total electricity usage across the scenarios, respectively. Baseline annual energy costs are again estimated using an electricity rate of 11.8 cents per kWh and \$11.6 per million BTU for natural gas.

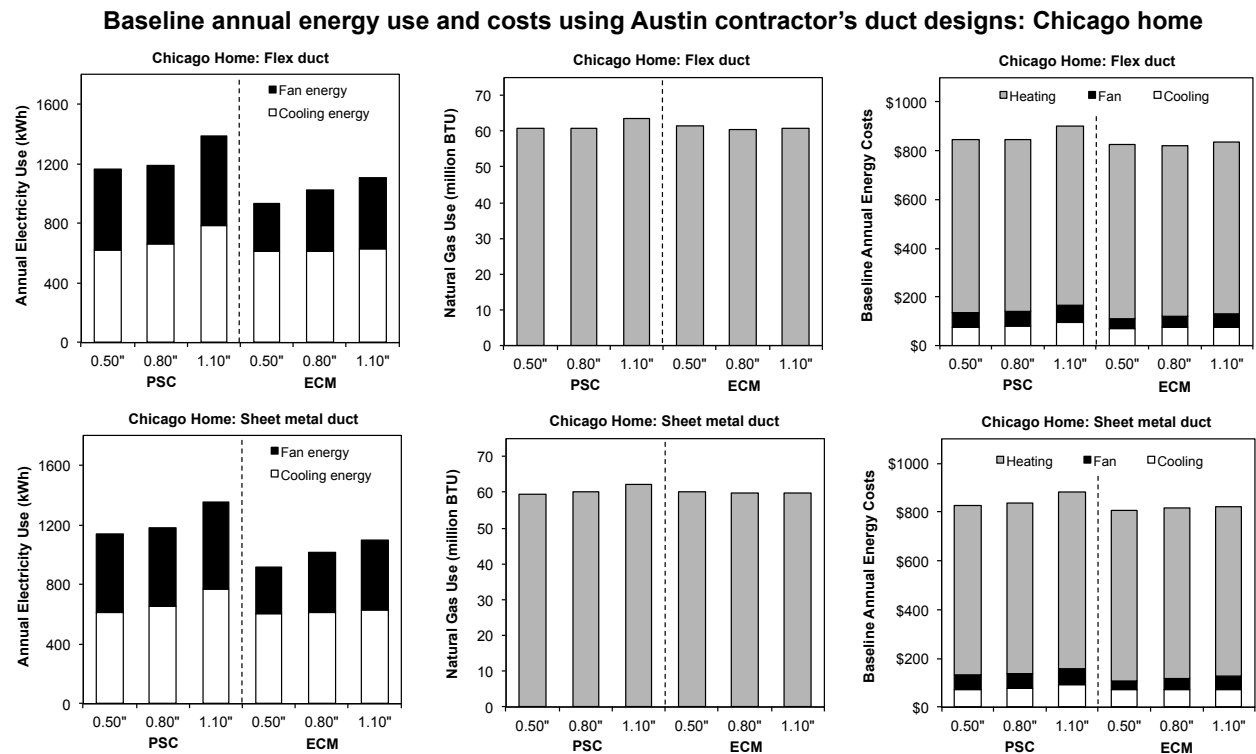

Figure 17. Estimated annual fan, cooling, and heating energy usage and total HVAC energy costs for the Chicago home (at baseline energy costs) with both types of AHU fans and both rigid and flex duct work at each duct design (using only the Austin contractor’s duct designs).

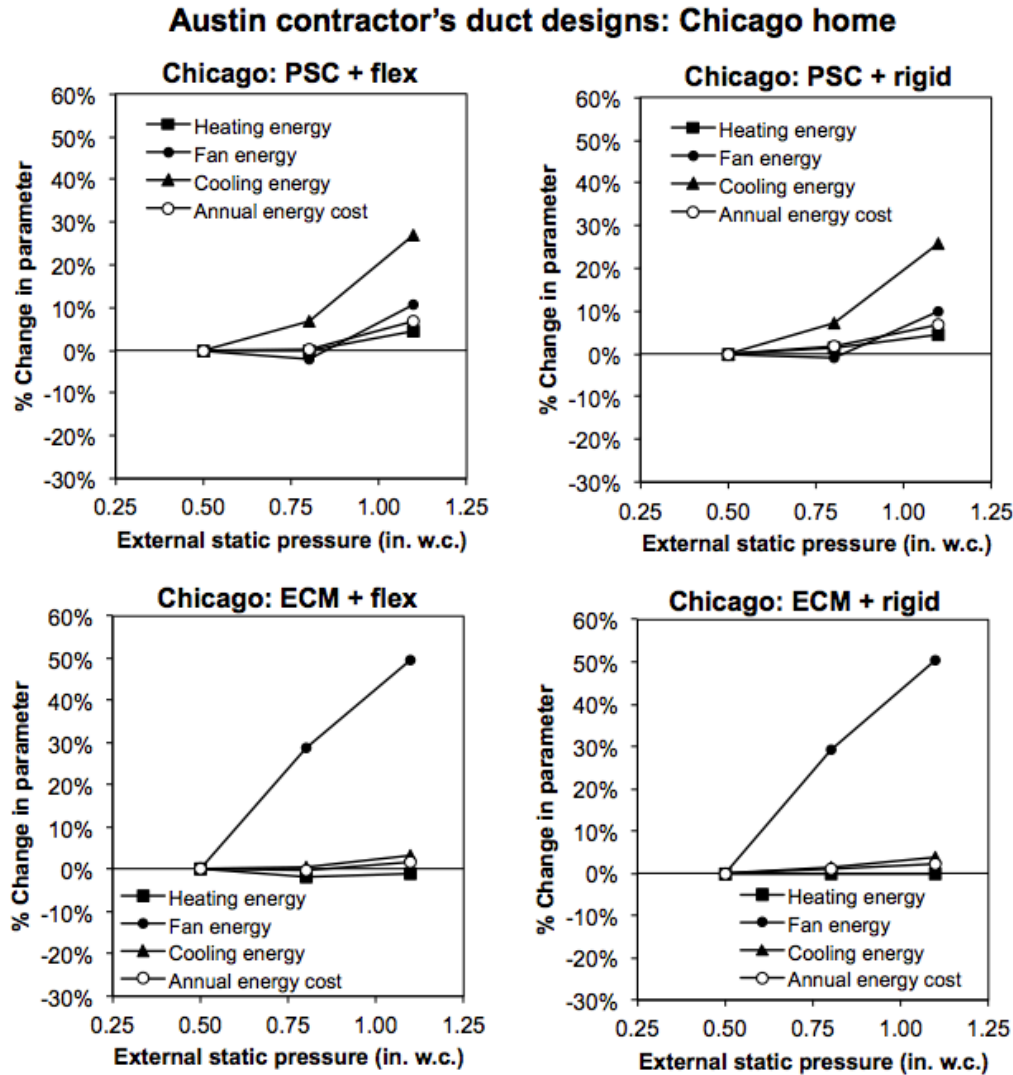

Figure 18. Estimated relative change in annual fan, cooling, and heating energy usage and total annual HVAC energy costs for the Chicago home with both types of AHU fans and both rigid and flex ductwork at each duct design (using only the Austin contractor’s duct designs).

Relative differences among design duct pressures were similar among rigid and flex ductwork in the Chicago home with the Austin contractor’s designs. For PSC blowers and both ductwork types, cooling energy increased by approximately 7% when moving from 0.50” to 0.80” and increased approximately 27% when moving from 0.50” to 1.10”. These were within 1% of the results using Chicago contractor’s designs. Annual fan energy decreased 2% when moving to 0.80”, and then increased by 11% when moving to 1.10” for the PSC+flex system, suggesting that the reduction in fan power draw observed at moderately increased static pressures was only partially negated by longer system runtimes. Similar changes of -1% and +10% were also predicted for the PSC+rigid system. These estimates were also within 1-2% of the results using the Chicago contractor’s designs. It should be noted that for the Chicago home, the average duct UA value across all scenarios was approximately 73% greater using the Chicago contractor’s duct designs versus the Austin contractor’s designs (average of 228 Btu/h·°F vs. 132 Btu/h·°F).

Full details of each contractor's designs are included in the appendix of this report, but the main differences were that the Chicago contractor utilized longer return ducts than the Austin contractor, and also used more complex, spider-like duct runs than the Austin contractor (particularly for flex duct).

For the ECM+flex system designed by the Austin contractor, there were only small increases in cooling energy consumption of 0% and +3% at 0.80" and 1.10" relative to 0.50", which again is generally appropriate for a very small (or negligible) change in airflow rates and cooling capacities. Correspondingly for the ECM+flex combinations, there was a 29% and 50% increase in fan energy consumption at the two higher pressures, respectively, due primarily to greater power draw of the ECM blowers at higher pressures. There was also a 1-2% reduction in heating energy at both of these two higher pressures, likely due mostly to increased reject heat from the fans as they drew more power at the higher pressures (also, flex duct UA values from the Austin contractor's designs were not very different from one another). Similarly for the ECM+rigid system, cooling energy increased 1% and 4% at 0.80" and 1.10" relative to 0.50"; fan energy increased 29% and 50%, and heating energy did not change at each of the same pressures. These values are all within a 1-3% of results using the Chicago contractor's designs in the Chicago home.

Overall, cooling energy and fan energy were increased by as much as 27% and 50%, respectively, at the highest pressures, but the combination of cooling and fan energy was typically only 14% of the total electricity consumption in this home. Overall, total HVAC energy costs in the baseline year were estimated to be ~0.4% higher and ~7% higher for the PSC+flex scenario when comparing 0.80" and 1.10" systems to 0.50", respectively. Similar results of ~1.6% higher and ~7% higher total HVAC energy costs for the PSC+rigid scenarios were observed for the same increases in pressure.

The impact on ECM scenarios was again smaller than PSC scenarios: total HVAC energy costs were between 0.2% lower (flex) and 1.2% higher (rigid) for 0.80" systems and between 1.6% higher (flex) and 2.4% higher (rigid) in the 1.10" systems, respectively, compared to the 0.50" systems. Therefore, these results suggest that in this particular home in this climate with these particular duct designs and under the aforementioned assumptions, the lowest duct pressures can lead to shorter system runtimes and up to 7% lower space conditioning energy costs for PSC blowers, but would have a smaller impact on energy use in systems with ECM blowers.

PSC vs. ECM: Chicago home. In the Chicago home simulations (using the Austin contractor's duct designs), total HVAC energy costs were consistently lower for ECM blowers than for PSC blowers. For example, cooling energy was 10% lower using ECM blowers with both types of ductwork; fan energy was 27-28% lower; space heating was ~1% lower; and total HVAC energy costs were ~4% lower when comparing between ECM and PSC blowers with similar ductwork types and averaged over all design pressures. These results are very similar to those estimated using the Chicago contractor's designs. These results again suggest that in this home under these assumptions, ECM blowers can save a small amount of energy annually (up to ~4% of annual energy costs) relative to the use of PSC blowers, regardless of duct design.

Rigid vs. flex ductwork materials: Chicago home. Rigid metal ductwork, which had a lower UA than flex duct at all pressures because of shorter, less complicated duct runs designed by the Austin contractor, also led to lower energy use for cooling, fans, and heating, although the magnitude of differences varied slightly by end-use. For example, the mean requirements for heating energy were 1-2% lower for rigid versus flex ducts; fan energy was 1-2% lower for rigid ducts; cooling energy was 1-1.5% lower for rigid ducts; and total annual HVAC energy costs were ~1.5-2% lower for rigid ducts than for flexible ductwork.

Overall, these results suggest that the lowest pressure ductwork designs by this contractor for this particular home will decrease annual energy costs for space conditioning relative to the highest pressure duct design by as much as ~7% if the system utilizes a PSC blower. Conversely, if an ECM blower is utilized, these lower pressure ductwork designs are predicted to have a small impact of total HVAC energy costs (less than 3% in most cases and sometimes in the direction of very slight, albeit mostly negligible, savings for moderate pressures). Additionally, the use of ECM blowers or rigid ductwork alone could save up to 2% and 4% on annual energy costs, respectively, if implemented individually. These results are very similar to the results obtained for the Chicago home using the Chicago contractors designs, which suggests that lower pressure duct systems may be financially viable in this home, particularly for PSC blowers.

Austin Home: Austin contractor designs

Baseline annual HVAC energy use and costs based on the Austin contractor's duct designs for the Austin home are shown in Figure 19 in a format similar to the previous figures. Space conditioning energy use accounted for 36-45% of the total amount of predicted electricity usage in the Austin home, depending on configuration, which is similar to results using the Chicago contractor's designs. The relative comparison between each of the three static pressures for each duct system and fan type for the Austin home as designed by the Austin contractor is also shown in Figure 20.

Baseline annual enerav use and costs usina Austin contractor’s duct designs: Austin home

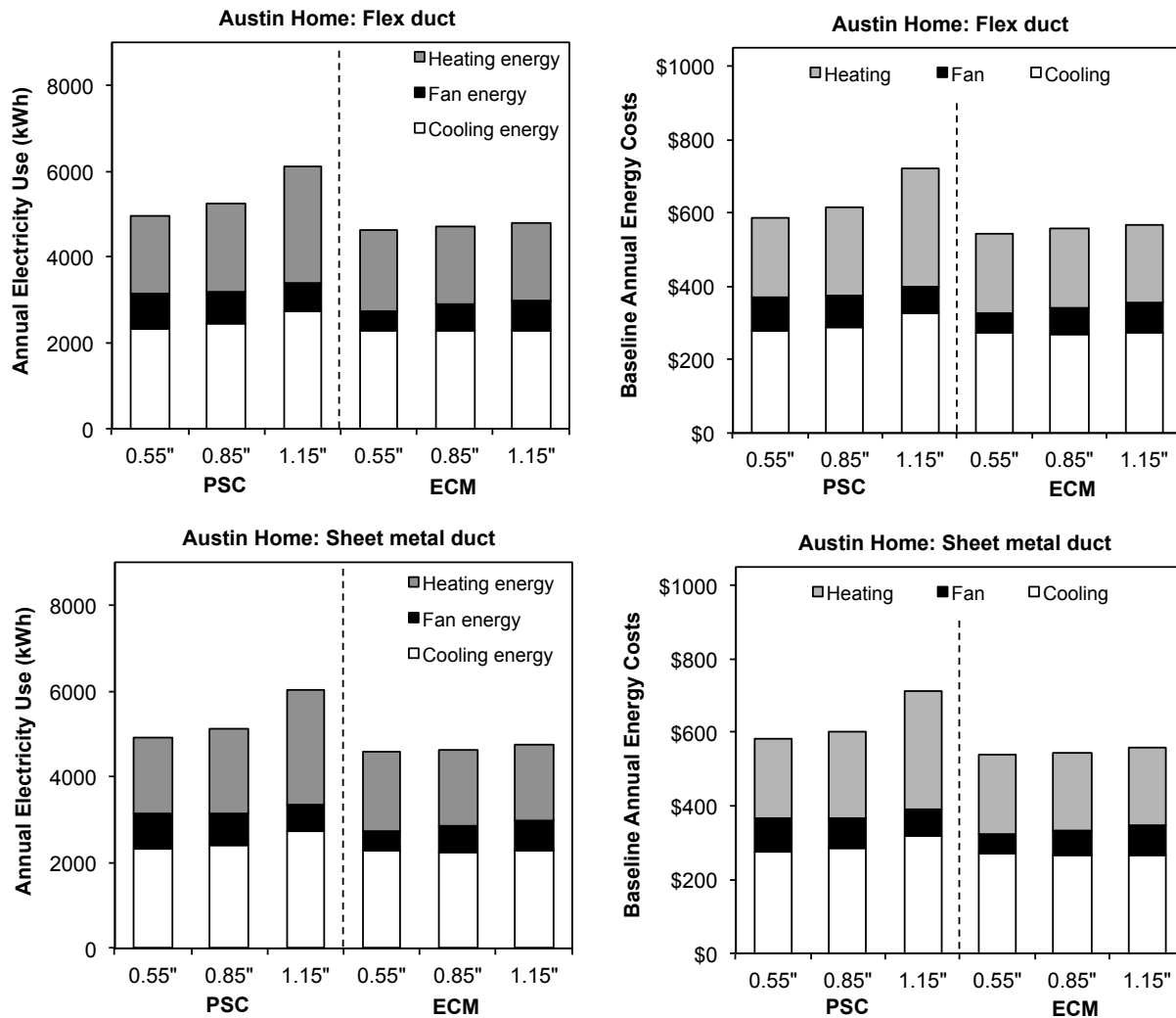

Figure 19. Estimated annual fan, cooling, and heating energy usage and total HVAC energy costs for the Austin home (at baseline energy costs) with both types of AHU fans and both rigid and flex duct work at each duct design (using only the Austin contractor’s duct designs).

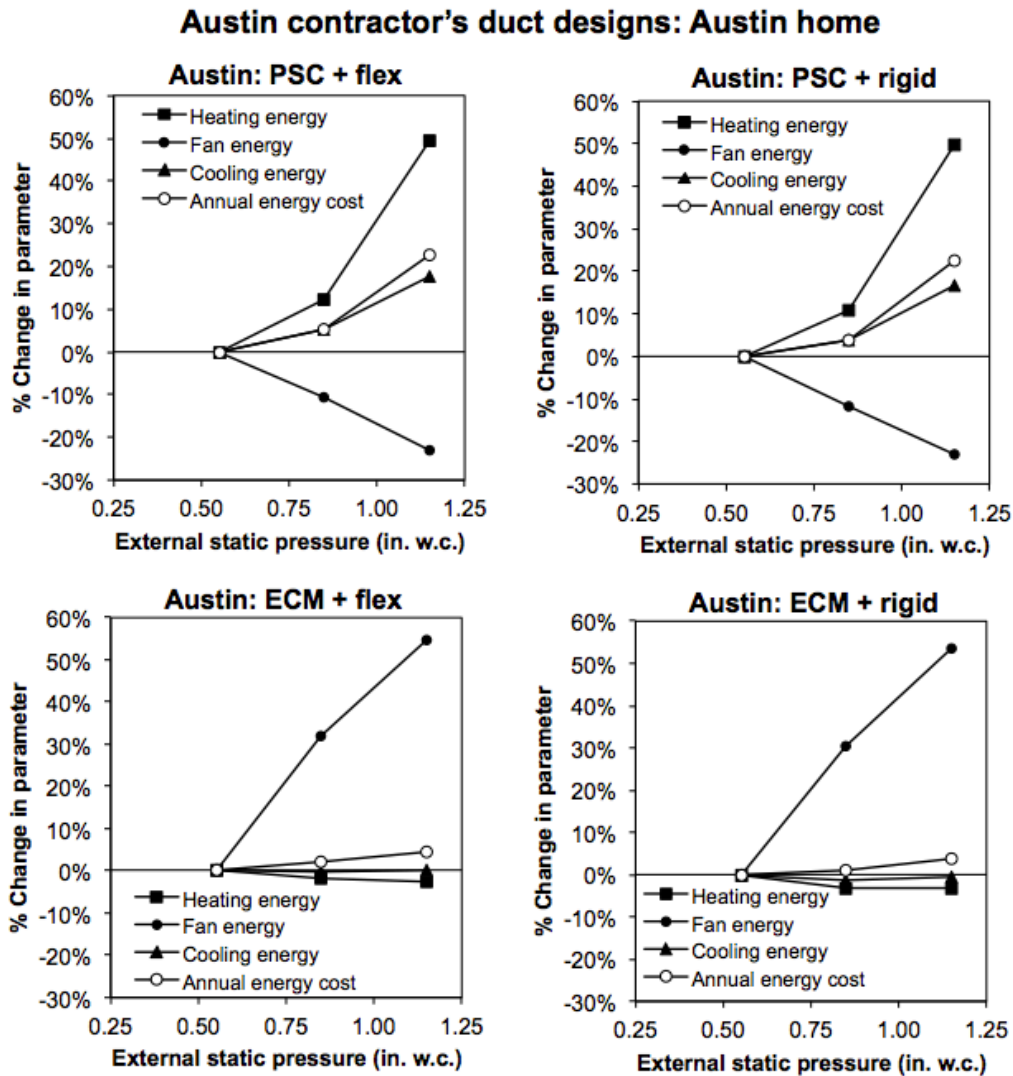

Figure 20. Estimated relative change in annual fan, cooling, and heating energy usage and total annual HVAC energy costs for the Austin home with both types of AHU fans and both rigid and flex duct work at each duct design (using only the Austin contractor's duct designs).

In the Austin home with PSC blowers and flexible duct work, cooling energy increased by 5% when moving from 0.55” to 0.85” and increased by almost 18% when moving from 0.55” to 1.15”. Impacts were similar for the PSC+rigid combinations: cooling energy increased 4% at 0.85” and increased 17% at 1.15”. Again, increases in cooling energy are due to a combination of longer system runtimes mitigated in part by a lower fan power draw (which rejects less heat into the airstream), lower compressor power draw, and reduced heat transfer across ductwork surfaces at the higher pressure designs. These results were very similar to those estimated using the Chicago contractor’s designs, albeit with some differences likely due to large differences in duct UA values between the two contractors’ designs.

Annual fan energy decreased 11% and 23% when moving to 0.85” and 1.15”, respectively, for the PSC+flex system, again suggesting an increase in static pressure may actually provide a

benefit in terms of fan energy because of reduced airflow rates and fan power draw requirements (and that these impacts were not offset by longer system runtimes). For the PSC+rigid system, annual fan energy decreased 12% and 23% at 0.85" and 1.15" relative to 0.55". Heating energy consumption increased approximately 12% for the 0.85" PSC+flex system and 49% for the 1.15" system, again similar to results using the Chicago contractor's designs. Results were also similar in the PSC+rigid systems: heating energy increased 11% at 0.85" and 50% at 1.15".

For the ECM+flex system, there was no observable change in cooling energy consumption at either 0.80" and 1.10", which captures the combined effects of excess heat rejected to the airstream by the AHU blowers drawing more power at greater pressures offset some by lower duct UA values from the Austin contractor's designs. Fan energy increased by 32% and 55% for the medium and high pressure ECM+flex designs, respectively. There was also a 2-3% reduction in heating energy at both of these higher pressures, most likely due to the combined effects of reduced heat transfer across the lower UA ductwork designs in the unconditioned attic and the addition of excess reject heat from the fans drawing higher power at higher pressures. Similarly for the ECM+rigid system, cooling energy decreased by less than 1.5% at both 0.85" and 1.15" relative to 0.55"; fan energy increased 30% and 54%; and heating energy decreased 3% at each of the same pressures.

Overall, these results suggest that the total change in annual heating and cooling energy use and thus HVAC energy costs at either of the higher pressures in the Austin home is again largely a function of the type of fan utilized, and that results were similar for both contractors' designs. For example, total HVAC energy costs (fan + cooling + heating combined) were 5% higher and 23% higher for the medium and high pressure PSC+flex combinations compared to their low pressure counterparts, respectively, and 4% and 22% higher for the medium and high pressure PSC+rigid combinations. Therefore, the lowest pressure duct designs in this home with a PSC blower could lead to substantial reductions in energy costs (as much as 22-23%) relative to those encountered using the highest pressure duct designs. Moderate pressure designs had a smaller impact, but still led to 4-5% higher heating and cooling energy consumption relative to the lowest pressures.

Conversely, for the ECM+flex combination, the medium and high pressure duct systems led to a 2% and 4% increase in total HVAC energy costs, respectively, due largely to reduced heating energy requirements with lower duct UA values. The Chicago contractor's designs, which had much higher flex duct UA values, were estimated to slightly *decrease* space conditioning energy costs, suggesting that excessive UA values for larger ductwork areas in the Chicago contractor's designs were masking the impacts of airflow rates and fan power draws in these combinations. In fact, average total HVAC energy across the ECM+flex combinations was predicted to be 13% lower using the Austin contractor's designs versus using the Chicago contractor's designs (which is tied directly to runtime changes as shown in Figure 21). For the ECM+rigid combination and the Austin contractor's designs, the medium pressure duct system led to a very small change in total HVAC energy costs (~1%) while the highest pressure duct system led to a 4% increase. Therefore, these particular lower pressure duct designs in this home with an ECM blower would likely decrease space conditioning costs, although the magnitude of changes was again predicted to be smaller than 5% for all scenarios.

Overall, the Austin home results for both contractors suggest that in this home in this climate with these duct designs and under the aforementioned assumptions, the combined effects of the lowest duct pressures will likely decrease space conditioning costs 22-25% with a PSC blower installed (compared to the highest pressure duct design), but could either slightly increase (as much as +4%) or decrease (as much as -4%) space conditioning costs with an ECM blower installed. The lowest pressure designs also have the ability to reduce annual space conditioning costs relative to the medium pressure design (as much as 5%), but can also lead to very small increases in costs depending on the actual duct design. Differences in annual space conditioning costs between the low and medium pressure designs using ECM blowers were almost always less than 1%.

PSC vs. ECM: Austin home. In the Austin home simulations (using the Austin contractor's duct designs), total HVAC energy costs also varied between ECM and PSC blowers. For example, total HVAC energy costs were 13% lower for ECM blowers versus PSC blowers with either type of ductwork due to the combined effects of a 9% decrease in cooling energy, a 19% reduction in fan energy, and a 17% decrease in heating energy. It appears that fan power and efficiency both drive the majority of the savings.

Rigid vs. flex ductwork materials: Austin home. Metal ductwork, which had a lower UA than flex duct at all pressures (although the difference was not as drastic using the Austin contractor's designs compared to the Chicago contractor's), led to only slightly lower energy usage and costs for space conditioning in the Austin home overall. For example, the mean requirements for cooling energy were ~1% lower for rigid versus flex ducts with either fan type; fan energy required was ~1% lower; and space heating energy was 1-2% lower for rigid ducts. Total annual HVAC energy costs were ~1.3-1.4% lower for rigid ducts compared to flex for both fan types. Only small savings are achievable because the Austin contractor's designs had duct UA values for flex duct that were only about 15-20% larger on average than the rigid sheet metal ductwork.

The full results from all of these simulations using the Austin contractor's designs are shown in Table 10.

Finally, the full annual HVAC energy costs results in the baseline year for both homes using both the Chicago and Austin contractor's designs are summarized in Table 11.

Table 10. Annual energy simulation results for both homes at baseline using the Austin contractor’s designs

Home	Duct type	Blower type	Total Pressure (in. w.c.)	Airflow rate (CFM)	Cooling (kWh)	AHU Fans (kWh)	Total Electricity (kWh)	Heating ($\times 10^6$ Btu)	Total Gas Consumption ($\times 10^6$ Btu)
Chicago 3-ton AC Gas furnace 1200 CFM nominal	Flex	PSC	0.50"	1200	619	542	8108	60.95	88.88
			0.80"	964	661	531	8139	60.93	88.85
			1.10"	622	786	600	8331	63.71	91.70
		ECM	0.50"	1200	611	319	7878	61.55	89.51
			0.80"	1162	614	411	7972	60.47	88.39
			1.10"	1103	631	478	8056	60.86	88.78
	Metal	PSC	0.50"	1200	611	531	8086	59.52	87.41
			0.80"	964	656	525	8128	60.25	88.16
			1.10"	622	769	583	8300	62.17	90.12
		ECM	0.50"	1200	603	314	7861	60.10	88.02
			0.80"	1162	611	406	7964	59.89	87.80
			1.10"	1103	625	472	8042	59.90	87.80
			Total Pressure (in. w.c.)	Airflow rate (CFM)	Cooling (kWh)	AHU Fans (kWh)	Heating Electricity (kWh)	Total HVAC Electricity (kWh)	Total Electricity (kWh)
Austin 4-ton heat pump 1600 CFM nominal	Flex	PSC	0.55"	1600	2342	808	1822	4972	12961
			0.85"	1316	2461	722	2042	5306	13211
			1.15"	916	2753	622	2722	6278	14086
		ECM	0.55"	1600	2303	453	1856	4611	12600
			0.85"	1590	2294	597	1819	4778	12700
			1.15"	1566	2303	700	1808	4914	12800
	Metal	PSC	0.55"	1600	2325	803	1803	4931	12917
			0.85"	1316	2417	708	1997	5269	13111
			1.15"	916	2717	617	2697	6267	14017
		ECM	0.55"	1600	2286	450	1836	4572	12561
			0.85"	1590	2256	586	1778	4736	12608
			1.15"	1566	2272	692	1778	4872	12731

Table 11. Annual HVAC energy costs (assuming baseline year gas and electricity costs) in all modeled scenarios with both the Chicago and Austin contractors' duct designs

Home	Duct type	Blower type	Total pressure (in. w.c.)	Airflow rate (CFM)	Total HVAC energy costs in baseline year	
					Chicago contractor	Austin contractor
Chicago 3-ton AC Gas furnace 1200 CFM nominal	Flex	PSC	0.50"	1200	\$871	\$844
			0.80"	964	\$869	\$847
			1.10"	622	\$918	\$903
		ECM	0.50"	1200	\$850	\$824
			0.80"	1162	\$841	\$822
			1.10"	1103	\$847	\$837
	Metal	PSC	0.50"	1200	\$838	\$825
			0.80"	964	\$839	\$838
			1.10"	622	\$880	\$881
		ECM	0.50"	1200	\$818	\$805
			0.80"	1162	\$816	\$815
			1.10"	1103	\$824	\$824
Austin 4-ton heat pump 1600 CFM nominal	Flex	PSC	0.55"	1600	\$711	\$587
			0.85"	1316	\$705	\$617
			1.15"	916	\$843	\$719
		ECM	0.55"	1600	\$660	\$544
			0.85"	1590	\$631	\$556
			1.15"	1566	\$646	\$568
	Metal	PSC	0.55"	1600	\$567	\$582
			0.85"	1316	\$580	\$604
			1.15"	916	\$712	\$712
		ECM	0.55"	1600	\$526	\$540
			0.85"	1590	\$527	\$545
			1.15"	1566	\$535	\$560

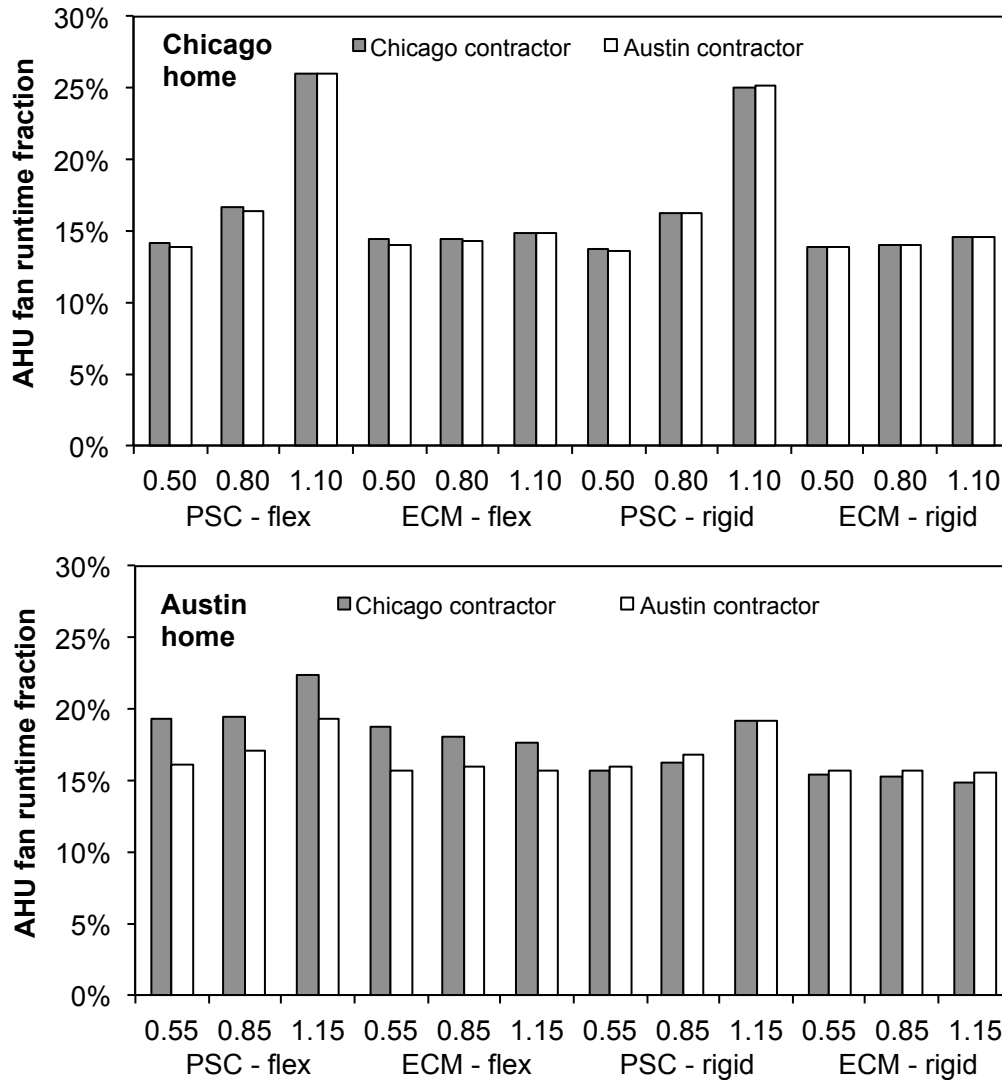

Figure 21. Annual AHU fan runtime fractions (combined heating and cooling) in all modeled scenarios with both the Chicago and Austin contractors' duct designs

Life cycle cost-benefit analysis

Although the single-year annual simulation results above were helpful for interpreting energy usage and operational cost impacts of each duct design and blower combination, a life cycle analysis was also conducted to determine the true cost-benefit relationship between differences in initial costs among duct configurations and subsequent increases or decreases in HVAC energy costs. As described in the methodology section, life cycle costs and benefits were explored first by summing the HVAC energy cost impacts over a 15-year lifetime assuming 15 years worth of constant annual HVAC energy savings (or increases) and accounting for annual increases in electricity rates, constant natural gas prices, and inflation. These data were explored separately for each contractor's designs, treating PSC and ECM blowers separately, and treating the *highest-pressure flex condition* as the baseline reference scenario. These comparisons are shown in the next section and in Figure 22 for the Chicago contractor's designs and Figure 23 for the Austin contractor's designs. The high pressure flex scenario was chosen as the reference case for these HVAC energy cost comparisons because most other scenarios were already shown to yield single-year annual HVAC energy savings due to a combination of higher airflow rates (and higher capacities) and lower duct UA values for most scenarios relative to the highest pressure flex condition.

Subsequently, the same HVAC energy cost estimates were used to estimate the net present value (NPV) of the initial investment over an assumed 15-year life cycle. This procedure accounted for long-term inflation and discount rates per standard procedures and allowed for a true comparison of the net benefits (in terms of HVAC energy savings) versus costs (in terms of initial design and installation costs). In both cases, the data were explored first by comparing both the medium and low system pressure conditions against the *highest-pressure* condition for each house and fan type and treating (1) flex duct systems and (2) rigid duct systems separately. Flex and rigid duct systems were treated separately to limit the cost comparisons to the impacts of duct pressures alone (which is the main focus of this study). Additionally, comparisons across ductwork types are not always appropriate. For example, in the City of Chicago, flexible nonmetallic ductwork is not even permitted in residential units per the building code, §18-28-603. In other settings, it may be standard industry practice for contractors to rely exclusively on flexible ductwork and thus rigid duct designs may seldom be used. Therefore, in comparing predicted NPVs to baseline high pressure ductwork conditions, we first treated flexible and rigid ductwork scenarios separately (i.e., a comparison of duct pressures within the same duct material). Fan types were also treated separately because we have not accounted for differences in initial costs of PSC versus ECM blowers. Once again, results from the Chicago and Austin contractors' duct designs are treated separately. These comparisons are shown in Figure 24 and Figure 25.

Subsequently, the same data were also explored for the same division of fan types but also comparing the medium and low pressure systems with both flex duct and rigid sheet metal duct materials to the *highest-pressure flex* condition in each case. This procedure allowed for a life cycle cost comparison *across* duct materials (i.e., of flex vs. rigid), although it is limited to several important assumptions and limitations outlined in the accompanying text in that section.

Lifetime (15-year) HVAC energy savings: All pressure, fan, and duct material scenarios

Chicago contractor designs. A comparison between HVAC energy costs when summed over a 15-year lifetime for each scenario and duct design (as designed by the Chicago contractor) is first shown in Figure 22. Positive values represent lifetime HVAC energy savings relative to the highest pressure flex design for each home and fan combination. Negative values represent excess HVAC energy costs relative to the same baseline condition.

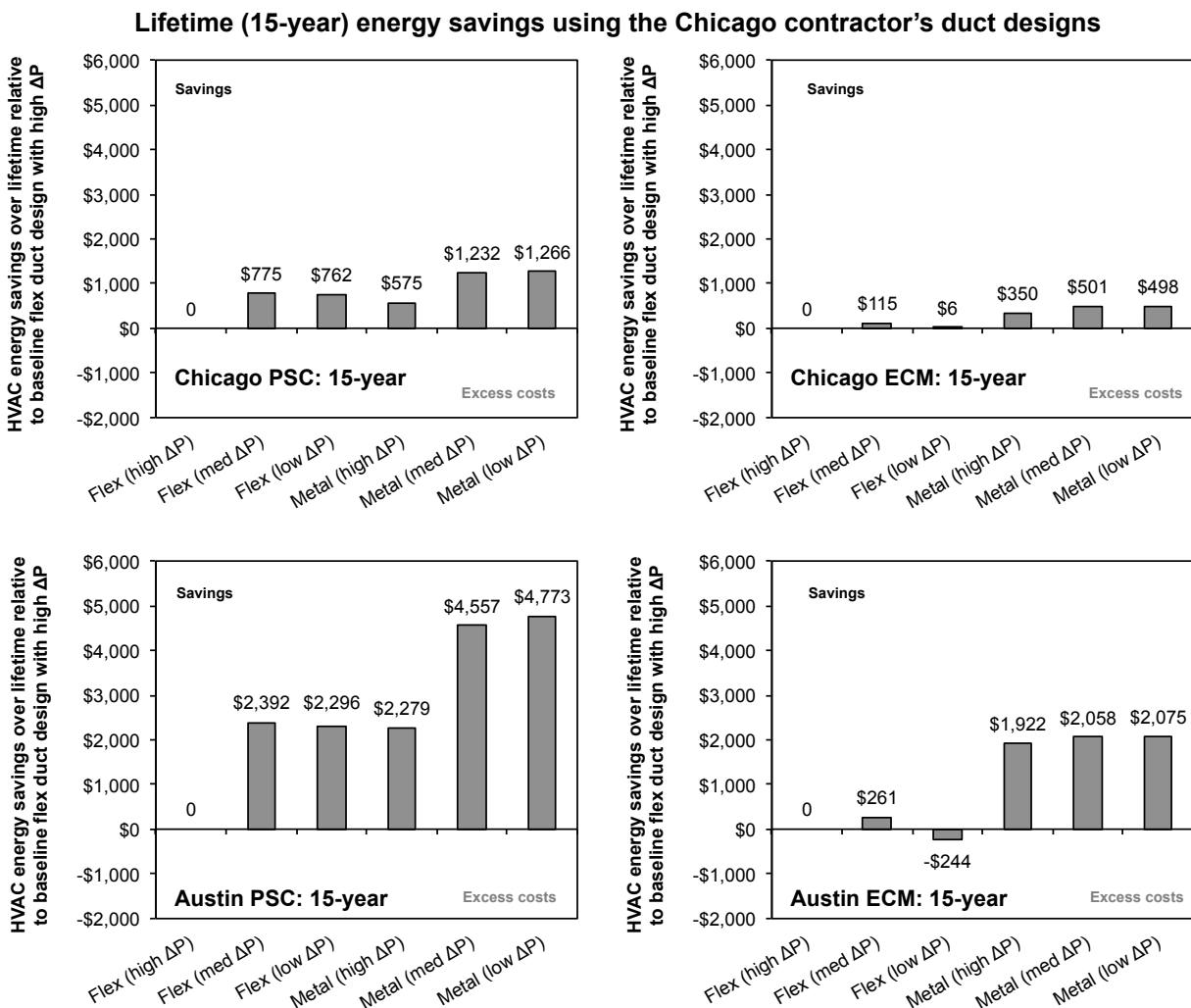

Figure 22. Estimated HVAC energy savings over a 15-year lifetime relative to those with a baseline high pressure flex duct design with each type of fan installed (duct designs are provided by the Chicago contractor). The high pressure case refers to 1.10” w.c. of total pressure for the Chicago home and 1.15” w.c. of total pressure for the Austin home. Positive values represent lifetime HVAC energy cost savings.

When summed over a 15-year lifespan, the lower pressure conditions with Chicago contractor’s designs were expected to yield energy savings over the high pressure flex condition for nearly all conditions. In general, lower pressure duct systems appear to have a greater impact on HVAC energy savings in systems with PSC blowers than in those with ECM blowers. For both homes with PSC blowers, the estimated impacts of medium and low pressure duct systems were very similar: in the Chicago home with a PSC blower, both medium and low pressure flex duct

systems were expected to yield 15-year energy savings of approximately \$760-775. Similarly in the Austin home with a PSC blower, medium and low pressure flex ductwork was expected to yield 15-year energy savings of approximately \$2300-2400.

Moving to medium or low pressure rigid ductwork was expected to increase savings by ~60% in the Chicago home and by almost 100% in the Austin home, suggesting that the lower UA values of the rigid ductwork materials with the Chicago contractor's designs yielded substantially higher HVAC energy savings relative to their high UA flex designs. In both homes with PSC blowers, the highest pressure rigid sheet metal duct system yielded lower energy savings than the other four comparison scenarios. The impacts with ECM blowers were not as drastic in either home. For the flex duct system, 15-year energy savings of low or medium duct pressures ranged from -\$6 to \$115 in the Chicago home and from -\$244 to \$261 in the Austin home. Savings were larger for rigid sheet metal ductwork, ranging from \$350 to \$501 in the Chicago home and from \$1922 to \$2075 in the Austin home.

Austin contractor designs. The same type of life cycle HVAC energy cost comparison for each scenario and duct design as designed by the Austin contractor is shown in Figure 23. Positive values again represent HVAC energy cost savings relative to the highest pressure flex design.

Fifteen-year lifetime HVAC energy savings with the Austin contractor's designs were similar in direction to those with the Chicago contractor's designs, although the magnitude of savings was greater for all cases in the Chicago home and smaller for most cases in the Austin home. These differences were largely attributable to large differences in duct UA values using the two contractors' designs.

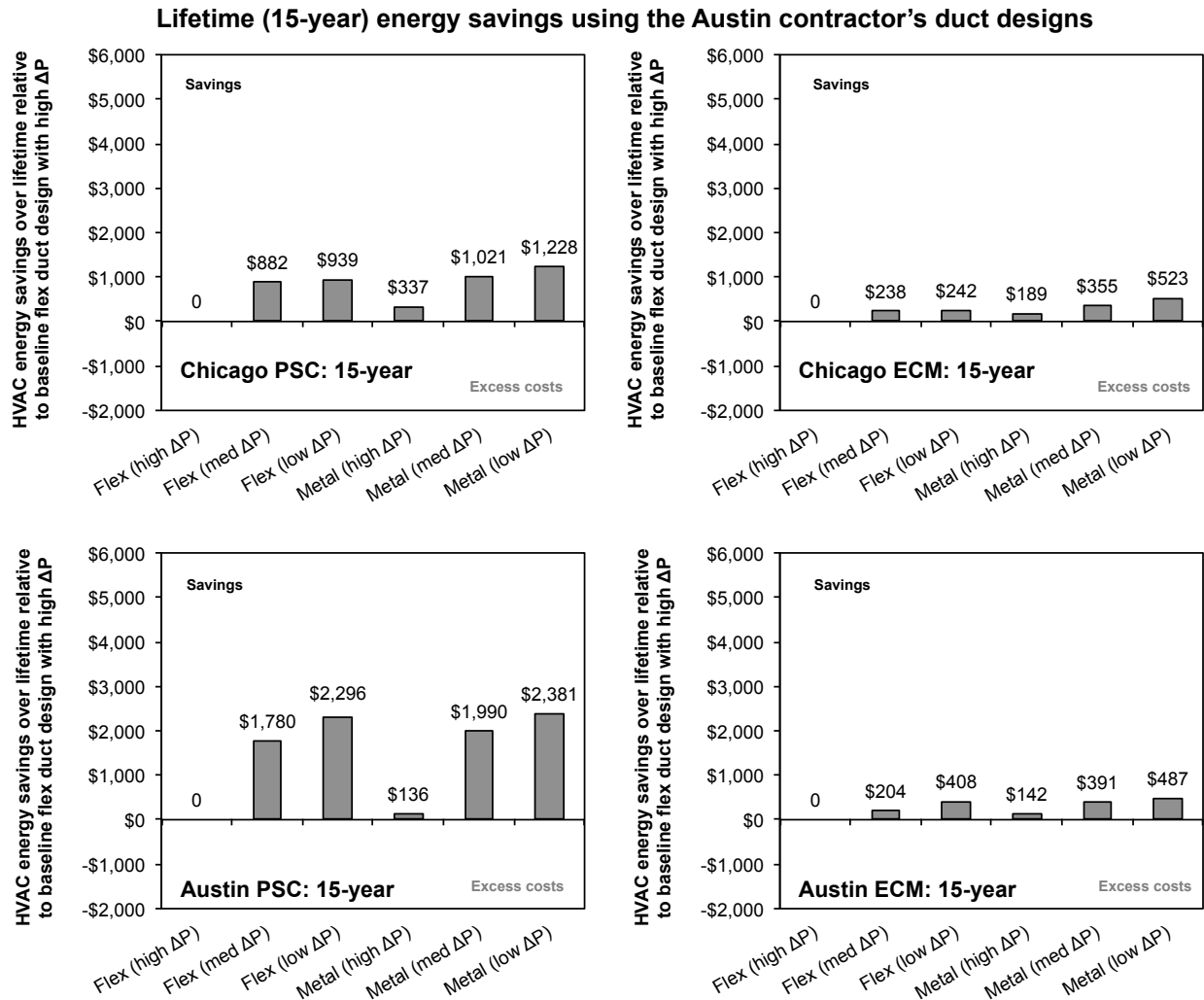

Figure 23. Estimated HVAC energy savings over a 15-year lifetime relative to those with a baseline high pressure flex duct design with each type of fan installed (duct designs are provided by the Austin contractor). The high pressure case refers to 1.10” w.c. of total pressure for the Chicago home and 1.15” w.c. of total pressure for the Austin home. Positive values represent lifetime HVAC energy cost savings.

Combined, these data suggest that nearly all medium or low pressure duct scenarios will yield HVAC energy cost savings over a 15-year lifetime. Additional HVAC energy savings appear achievable using lower UA value rigid ductwork material (which typically involved less complex duct runs and thus lower ductwork surface area installed in unconditioned spaces). However, the next section combines the predicted differences in life cycle HVAC energy costs with differences in initial duct design and installation cost estimates to estimate the overall life cycle cost/benefit of each scenario in terms of net present value (NPVs). Flex duct scenarios and rigid duct scenarios were first treated independently, followed by an exploration across both duct materials.

NPV analysis assuming 15-year life cycle: Flex duct only

In the NPV calculation procedure, we assumed that the entire cost of duct design and installation was incurred in the initial year (year 0). Subsequently, the total annual electricity and/or natural gas usage simulated for each home was assumed to remain constant each year for the following 15 years, which is generally appropriate considering that typical meteorological year (TMY) data drive the simulation inputs. As previously mentioned, electricity rates were assumed to increase 2% per year and natural gas costs were assumed to remained constant.

Figure 24 shows 15-year NPVs estimated for both the Chicago and Austin homes using only the Chicago contractor’s flex duct designs. Similarly, Figure 25 shows 15-year NPVs estimated for both homes using only the Austin contractor’s flex duct designs.

Lifetime (15-year) net present values (NPV) using the Chicago contractor’s duct designs: Flex only

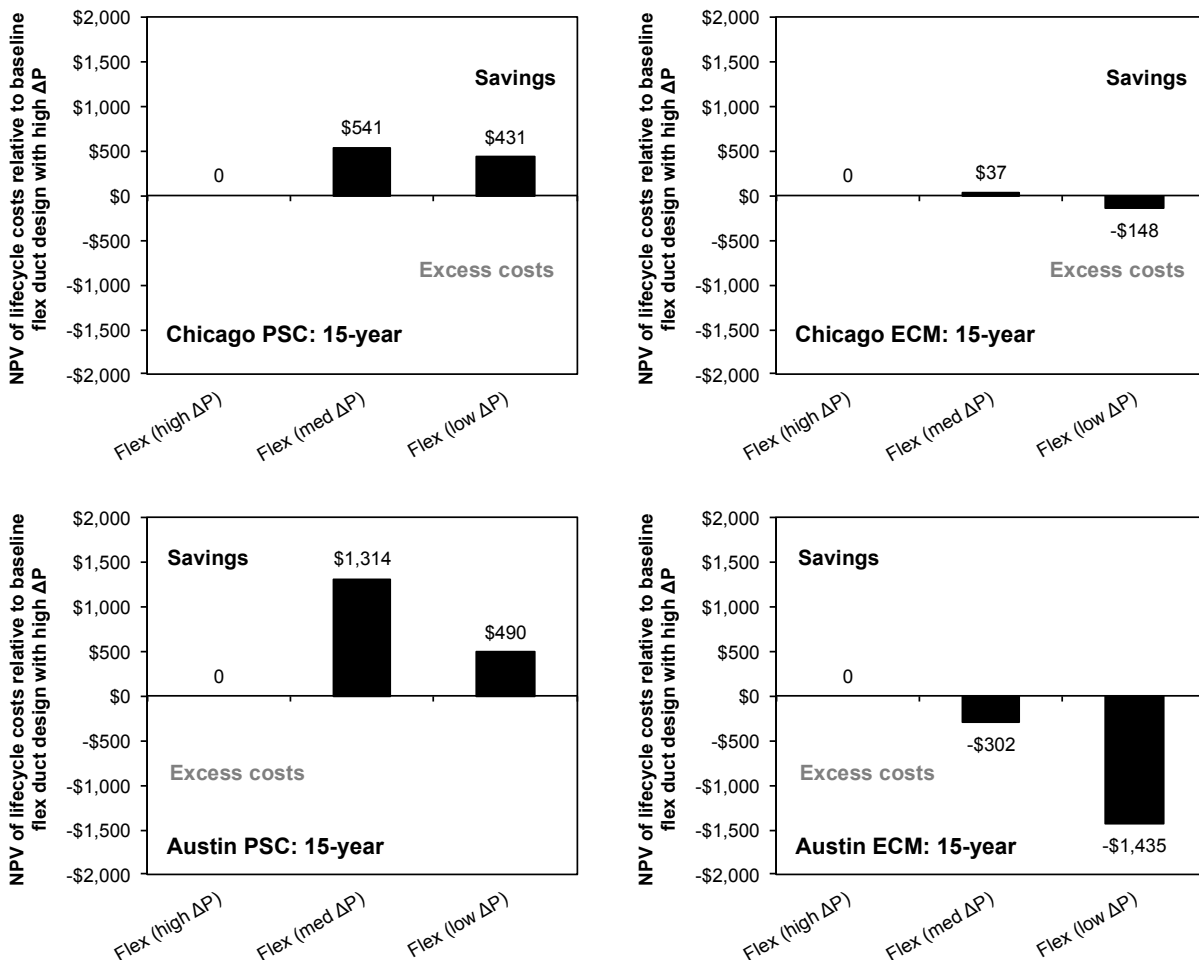

Figure 24. Net present value (NPV) of the life cycle costs of flex duct designs over 15-year life relative to a high pressure flex duct design in each location and with each type of fan installed (duct designs are provided by the Chicago contractor). The high pressure case refers to 1.1” w.c. of total pressure for the Chicago home and 1.15” w.c. of total pressure for the Austin home. Positive values represent scenarios with lifetime savings. Comparisons are limited to flex duct designs only.

Lifetime (15-year) net present values (NPV) using the Austin contractor’s duct designs: Flex only

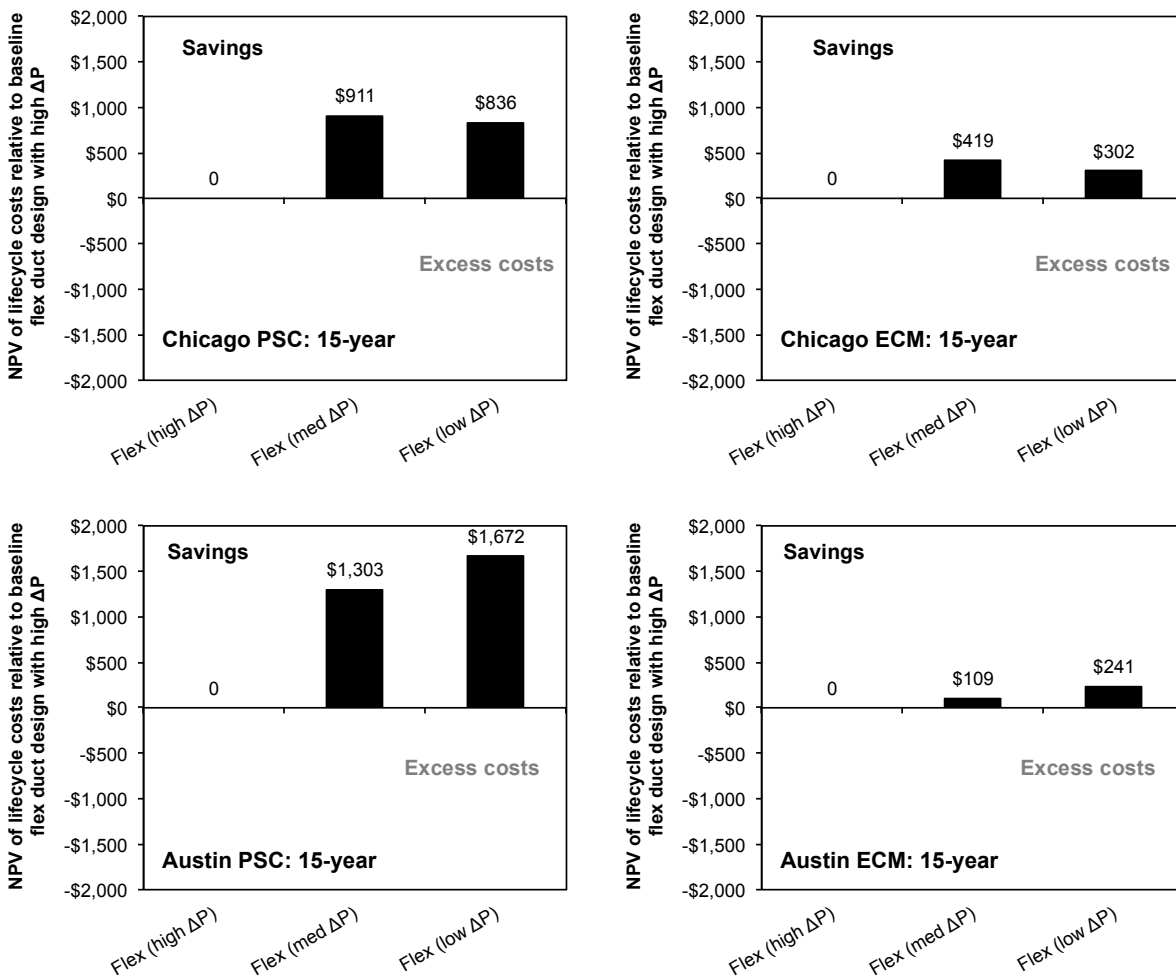

Figure 25. Net present value (NPV) of the life cycle costs of flex duct designs over 15-year life relative to a high pressure flex duct design in each location and with each type of fan installed (duct designs are provided by the Austin contractor). The high pressure case refers to 1.1” w.c. of total pressure for the Chicago home and 1.15” w.c. of total pressure for the Austin home. Positive values represent scenarios with lifetime savings. Comparisons are limited to flex duct designs only.

For the PSC+flex combinations, lower pressure duct designs were predicted to have 15-year NPVs ranging from approximately \$430 to \$1670, depending somewhat on pressure but more so on contractor design (i.e., the combined effects of duct UA and initial cost estimates). For the Chicago contractor’s designs, the medium pressure PSC+flex combination yielded the highest NPVs; for the Austin contractor’s PSC+flex combinations, the lowest pressure PSC+flex combination yielded the highest NPV in the Austin home and was similar to the medium pressure results in the Chicago home.

For ECM+flex systems, 15-year NPVs ranged from a savings of \$37 to an excess cost of \$1435 with the Chicago contractor’s designs; the Austin contractor’s designs yielded savings in all lower pressure scenarios ranging from \$109 to \$419, again with the medium pressure duct system in the Chicago home having a higher NPV than the low pressure system and vice versa in

the Austin home. These results suggest that within flexible duct systems only, both medium and low pressure duct systems can result in significant life cycle costs savings over a 15-year period, particularly for PSC systems and often for ECM systems, although the savings were not as large and may vary depending on actual duct designs and costs.

To provide a more concise summary of these results, Table 12 also summarizes these results using a simple nomenclature, whereby a positive NPV for a scenario (i.e., a scenario with life cycle cost savings) is marked with a positive sign (+) and scenarios with excess life cycle costs are marked with a negative sign (-).

Table 12. Summary of 15-year NPV analysis for flex ducts only

Home	Contractor	Blower	15-year NPV relative to high pressure flex ¹	
			Flex low	Flex medium
Chicago	IL	PSC	+	+
		ECM	-	+
	TX	PSC	+	+
		ECM	+	+
Austin	IL	PSC	+	+
		ECM	-	-
	TX	PSC	+	+
		ECM	+	+
Number of scenarios w/ savings:			6/8	7/8

¹Positive signs (+) reflect life cycle cost savings. Negative signs (-) reflect excess life cycle costs.

According to Table 12, the lower pressure flex duct designs reflect life cycle cost savings over the high pressure flex designs in most of the modeled scenarios: six out of eight scenarios for the lowest pressure flex systems and seven out of eight scenarios for the medium pressure flex duct systems.

NPV analysis assuming 15-year life cycle: Rigid ducts only

Similar to the analysis for flex duct designs only above, Figure 26 shows 15-year NPVs estimated for the Chicago and Austin homes using only the Chicago contractor’s rigid duct designs. Similarly, Figure 27 shows 15-year NPVs estimated for both homes using only the Austin contractor’s rigid duct designs. In both cases, life cycle costs of the medium and low pressure rigid designs are compared to the highest pressure rigid designs. Table 13 also summarizes these same data using the simplified “+/-” nomenclature used in the previous summaries.

Lifetime (15-year) net present values (NPV) using the Chicago contractor’s duct designs: Rigid only

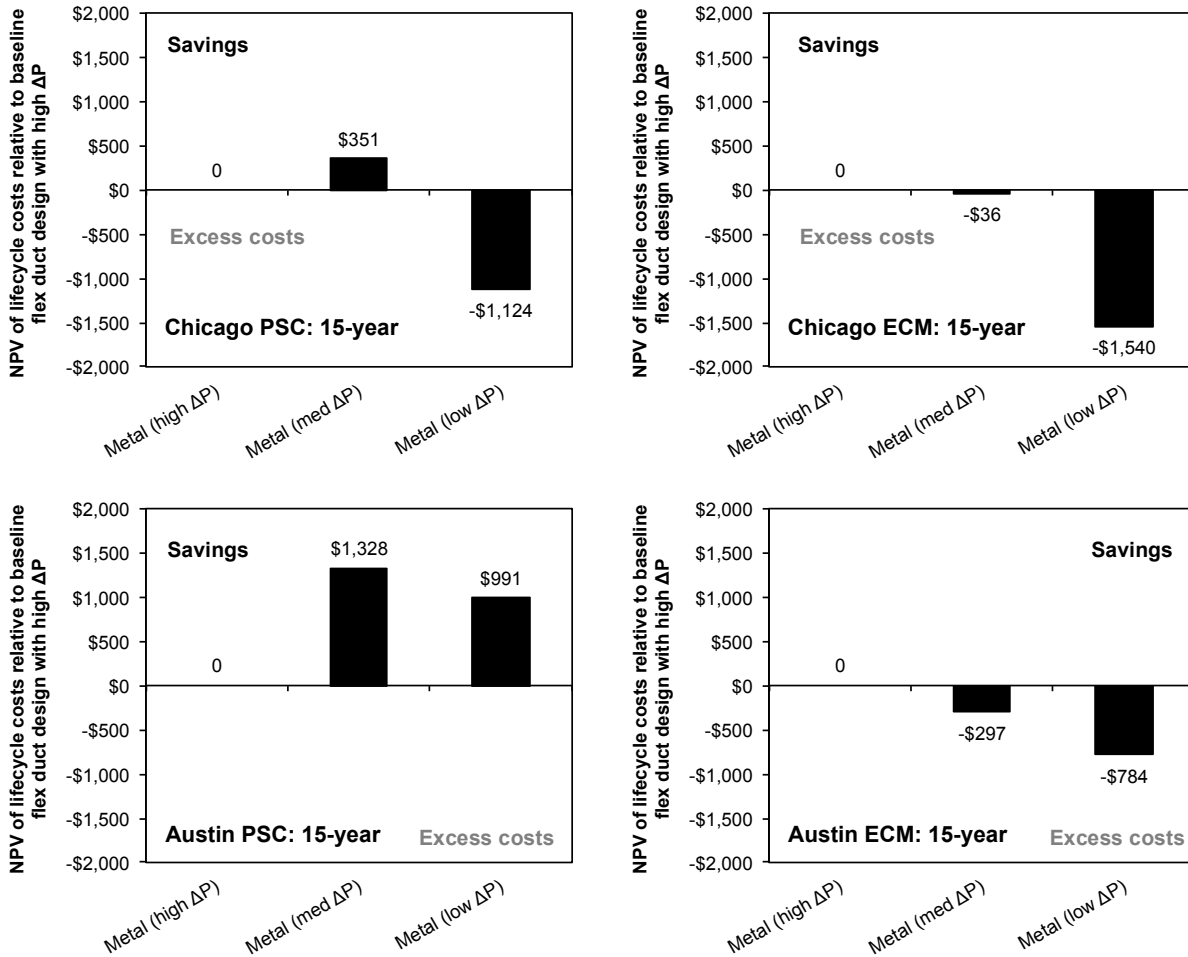

Figure 26. Net present value (NPV) of the life cycle costs of rigid duct designs over 15-year life relative to a high pressure rigid duct design in each location and with each type of fan installed (duct designs are provided by the Chicago contractor). The high pressure case refers to 1.1” w.c. of total pressure for the Chicago home and 1.15” w.c. of total pressure for the Austin home. Positive values represent scenarios with lifetime savings. Comparisons are limited to rigid duct designs only.

Lifetime (15-year) net present values (NPV) using the Austin contractor’s duct designs: Rigid only

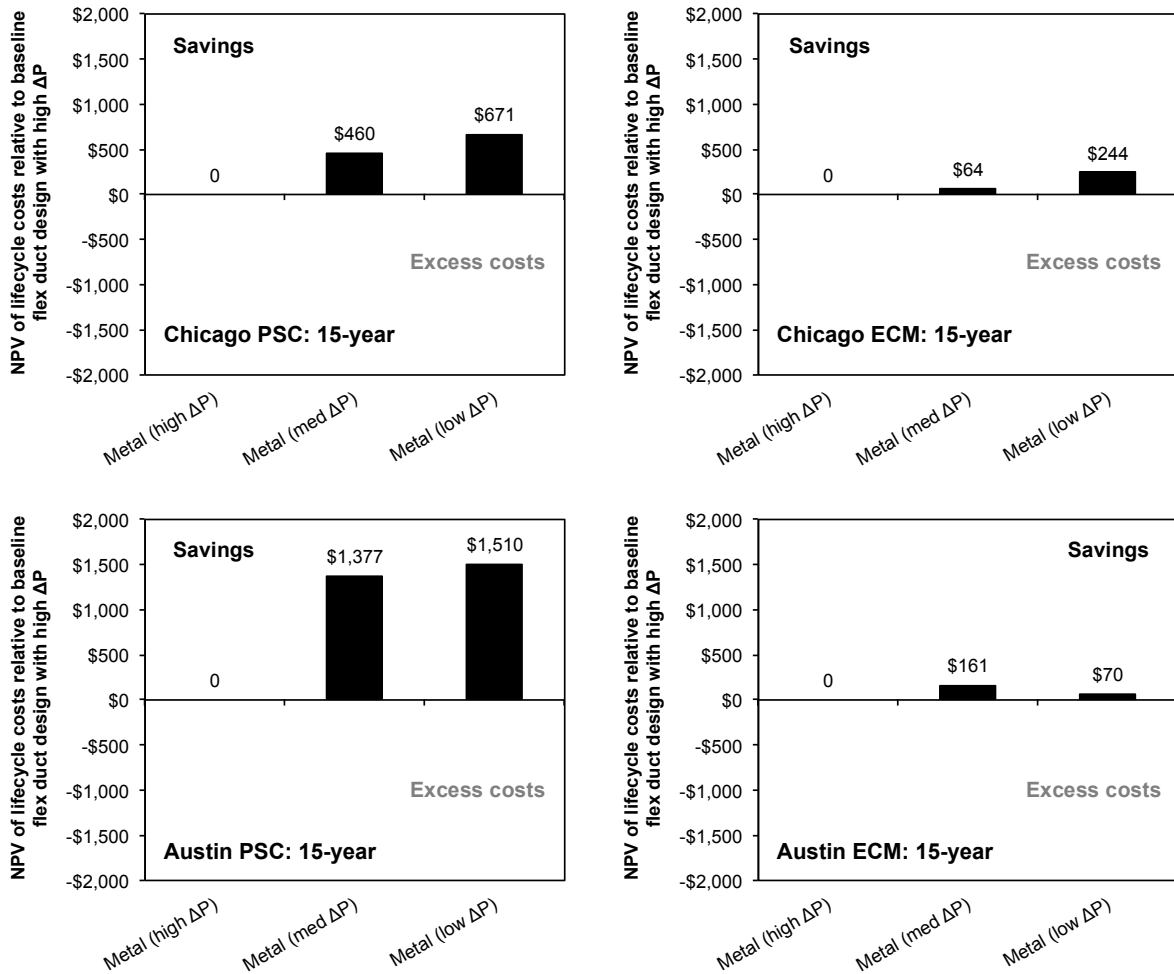

Figure 27. Net present value (NPV) of the life cycle costs of rigid duct designs over 15-year life relative to a high pressure rigid duct design in each location and with each type of fan installed (duct designs are provided by the Austin contractor). The high pressure case refers to 1.1” w.c. of total pressure for the Chicago home and 1.15” w.c. of total pressure for the Austin home. Positive values represent scenarios with lifetime savings. Comparisons are limited to rigid duct designs only.

Table 13. Summary of 15-year NPV analysis for rigid ducts only

Home	Contractor	Blower	15-year NPV relative to high pressure rigid ¹	
			Rigid low	Rigid medium
Chicago	IL	PSC	-	+
		ECM	-	-
	TX	PSC	+	+
		ECM	+	+
Austin	IL	PSC	+	+
		ECM	-	-
	TX	PSC	+	+
		ECM	+	+
Number of scenarios w/ savings:			5/8	6/8

¹Positive signs (+) reflect life cycle cost savings. Negative signs (-) reflect excess life cycle costs.

Limiting life cycle cost comparisons to within rigid systems alone, the lower pressure rigid duct designs also reflected life cycle cost savings over the high pressure rigid designs in most of the modeled scenarios: five out of eight scenarios for the lowest pressure rigid systems and six out of eight scenarios for the medium pressure rigid duct systems. This is particularly true for PSC blowers, but also for some ECM scenarios. However, the magnitude (and sometimes direction) of savings may change depending on fan type, level of pressure, and individual contractor duct designs and initial cost estimates. For example, all of the lower pressure duct designs from the Austin contractor yielded life cycle cost savings (ranging from \$460 to \$1510 for PSC+rigid combinations and from \$64 to \$244 for ECM+rigid combinations); the only scenarios that did not yield life cycle savings were those using the Chicago contractor's designs and estimates. ECM scenarios using the Chicago contractor's designs yielded excess life cycle costs in both homes and only one PSC scenario (low pressure in the Chicago home with the Chicago contractor's designs) was expected to yield excess life cycle costs. This was due to a combination of excess ductwork costs and higher duct UA values using only the Chicago contractor's designs; the Austin contractor's designs did not reflect such dramatic changes in upfront costs or duct UA. Details of individual contractor designs thus can have a very large impact on the economics of lower pressure duct systems in residences.

Overall, these results suggest that within the constraints of using rigid duct materials, low pressure duct systems can yield significant savings in systems with PSC blowers (i.e., up to ~\$1500), depending on contractor design characteristics and upfront costs. In systems with ECM blowers, lower pressure duct systems can either yield slight life cycle cost savings or as much as ~\$1500 in excess life cycle costs in these two homes, depending primarily on contractor cost estimates and specific duct design details.

NPV analysis assuming 15-year life cycle: Comparing both flex and rigid duct scenarios

There are also cases where one has the option to select either flexible or rigid metal duct materials. Therefore, we have provided an additional life cycle cost comparison of each of the modeled scenarios comparing both flex and rigid duct materials, all referenced to what was originally expected to be the least expensive initial cost scenario: the highest pressure flex condition. Figure 28 shows net present values (NPV) calculated for each of the Chicago contractor’s designs and Figure 29 shows NPVs for the Austin contractor’s designs. Both the medium and low pressure flex designs, as well as the low, medium, and high pressure rigid designs, were compared to the highest pressure flex duct design in this analysis. Positive values again indicate scenarios that yielded net savings over an assumed 15-year lifetime. Importantly, this analysis assumed that each duct type is equally capable of achieving the target pressures specified. In reality, flexible ductwork materials are much more likely to be constricted during construction due to installation with excessive compression, excessive sag, or being pinched by wires and cables. Therefore these results should be interpreted with some caution.

Lifetime (15-year) net present values (NPV) using the Chicago contractor’s duct designs

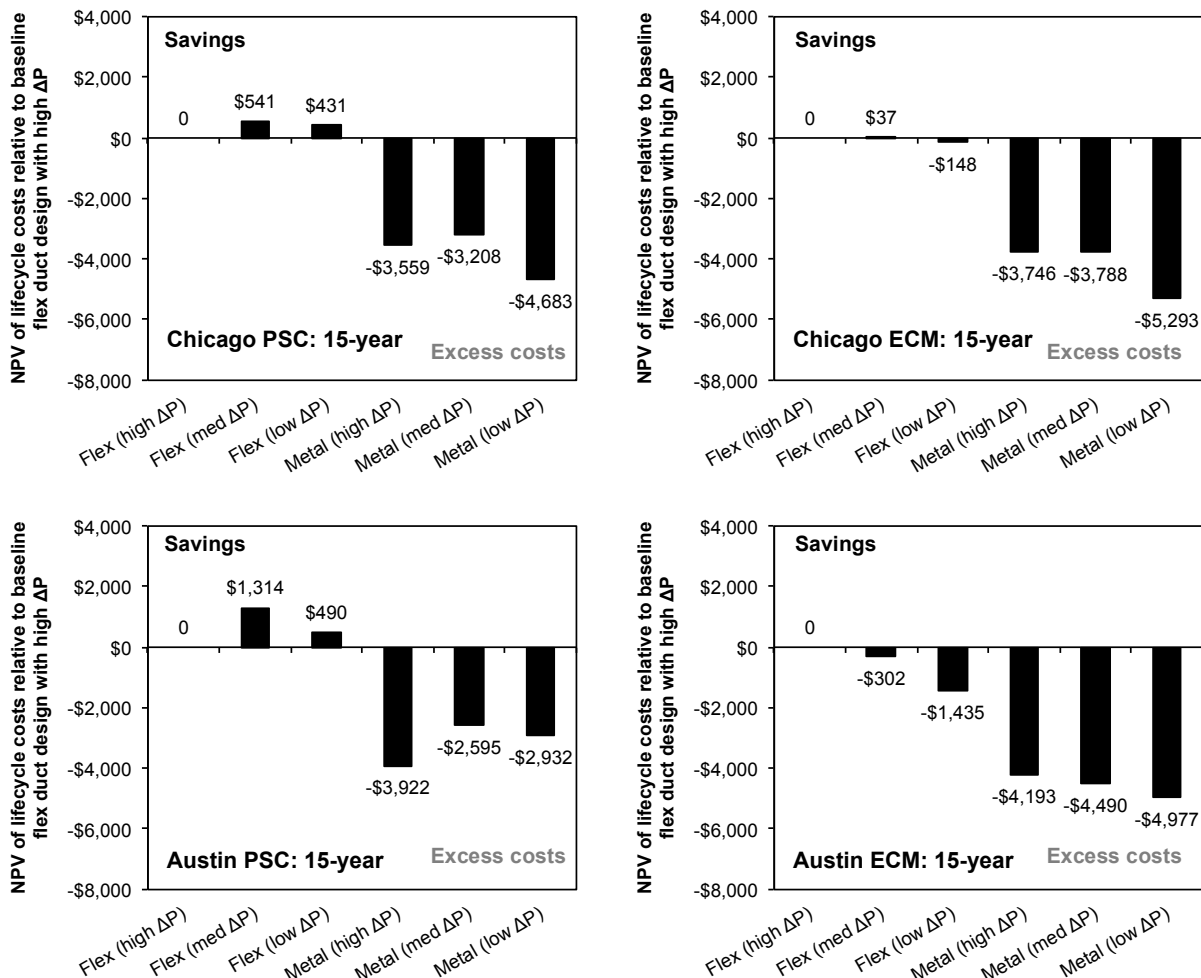

Figure 28. Net present value (NPV) of the life cycle costs of both flex and rigid duct designs over 15-year life relative to a high pressure flex duct design in each location and with each type of fan installed (duct designs are provided by the Chicago contractor). The high pressure case refers to 1.1” w.c. of total pressure for the Chicago home and 1.15” w.c. of total pressure for the Austin home. Positive values represent scenarios with life cycle cost savings.

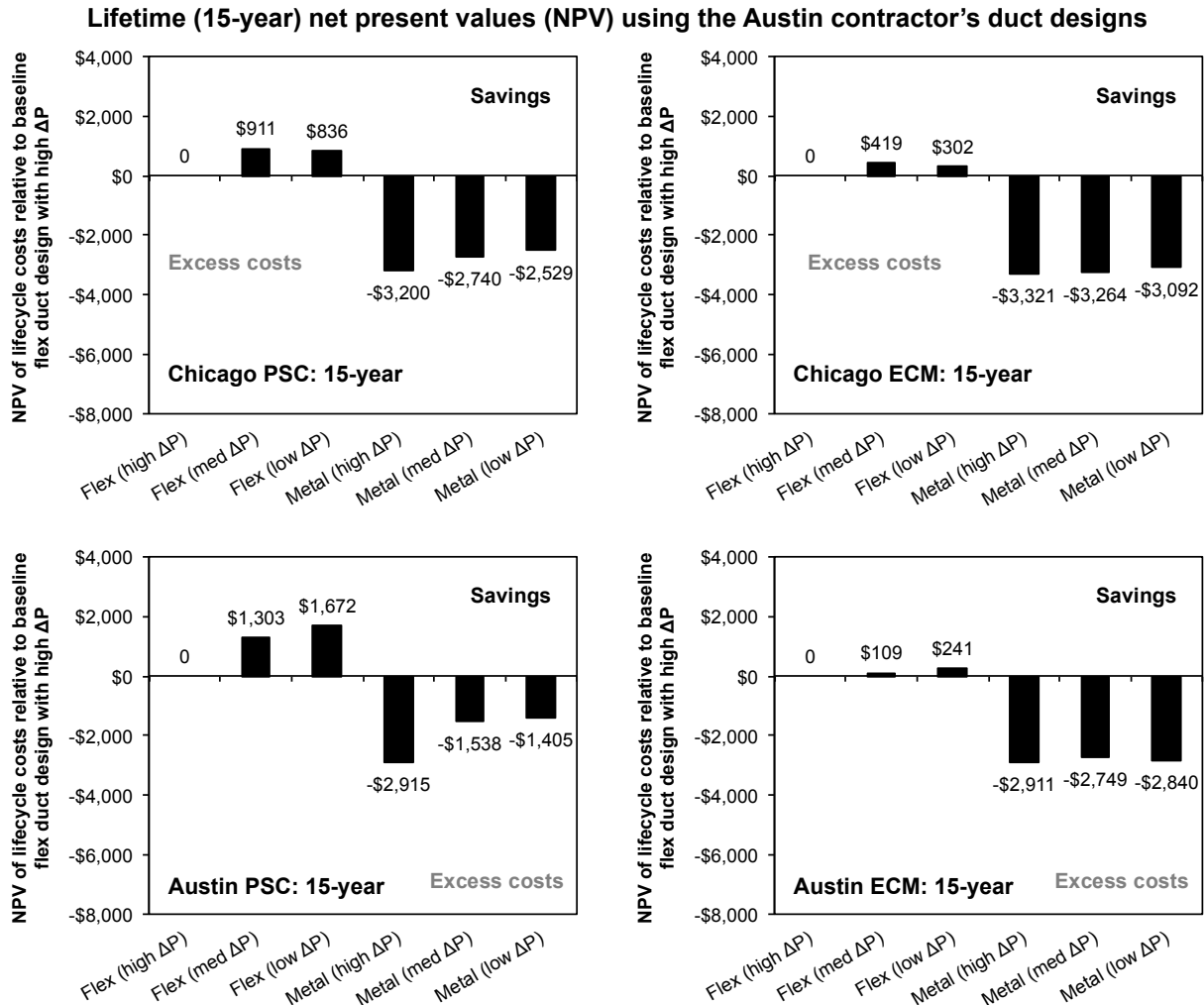

Figure 29. Net present value (NPV) of the life cycle costs of both flex and rigid duct designs over 15-year life relative to a high pressure flex duct design in each location and with each type of fan installed (duct designs are provided by the Austin contractor). The high pressure case refers to 1.1” w.c. of total pressure for the Chicago home and 1.15” w.c. of total pressure for the Austin home. Positive values represent scenarios with life cycle cost savings.

Table 14 provides a concise summary of these results comparing both ductwork materials for both homes with designs from both contractors using the same simple nomenclature as in previous sections. Again, most of the medium and low pressure flex duct designs were predicted to yield life cycle cost savings relative to the high pressure flex designs across both homes and both contractor designs. Six out of eight low pressure flex duct scenarios were expected to yield life cycle cost savings while seven out of eight medium pressure flex duct scenarios were expected to yield savings. These results are the same as the flex only section above. However, in this analysis none of the rigid duct scenarios were expected to yield life cycle savings; their initial cost estimates from both contractors were too high relative to any expected annual HVAC energy cost savings. These results suggest that for this particular home in this particular climate and under the assumptions described herein, lower pressure duct designs yield 15-year life cycle savings only for flexible ductwork. Switching to rigid ductwork and assuming that the target pressures can be met does not yield life cycle cost savings because of very high upfront costs.

However, as mentioned, this analysis is limited to the assumption that both ductwork materials are equally likely to achieve the desired pressures.

Table 14. Summary of 15-year NPV analysis for both flex and rigid ductwork

			15-year NPV relative to high pressure flex ¹				
Home	Contractor	Blower	Flex low	Flex medium	Rigid low	Rigid medium	Rigid high
Chicago	Chicago	PSC	+	+	-	-	-
		ECM	-	+	-	-	-
	Austin	PSC	+	+	-	-	-
		ECM	+	+	-	-	-
Austin	Chicago	PSC	+	+	-	-	-
		ECM	-	-	-	-	-
	Austin	PSC	+	+	-	-	-
		ECM	+	+	-	-	-
Number of scenarios w/ savings:			6/8	7/8	0/8	0/8	0/8

¹Positive signs (+) reflect positive NPVs (i.e., life cycle cost savings). Negative signs (-) reflect excess life cycle costs.

Optimization and sensitivity based on the simulation results

There were a total of 48 scenarios modeled herein, which complete a simulation matrix comprising two contractors' duct designs, two model homes, two types of blower motors, two types of duct materials, and three levels of duct pressures. If flexible and rigid duct materials are treated separately, sixteen of these simulations represent baseline high pressure duct designs, leaving a total of 32 lower pressure comparison scenarios. All of the results of the NPV analysis for these 32 scenarios are summarized in Figure 30 with high pressure systems as a reference for comparison. The Chicago home is summarized at the top of Figure 30 and the Austin home is summarized at the bottom of Figure 30. The figures include NPVs based on both Chicago (IL) and Austin (TX) contractor duct designs and cost estimates.

Chicago Home: NPV Summary

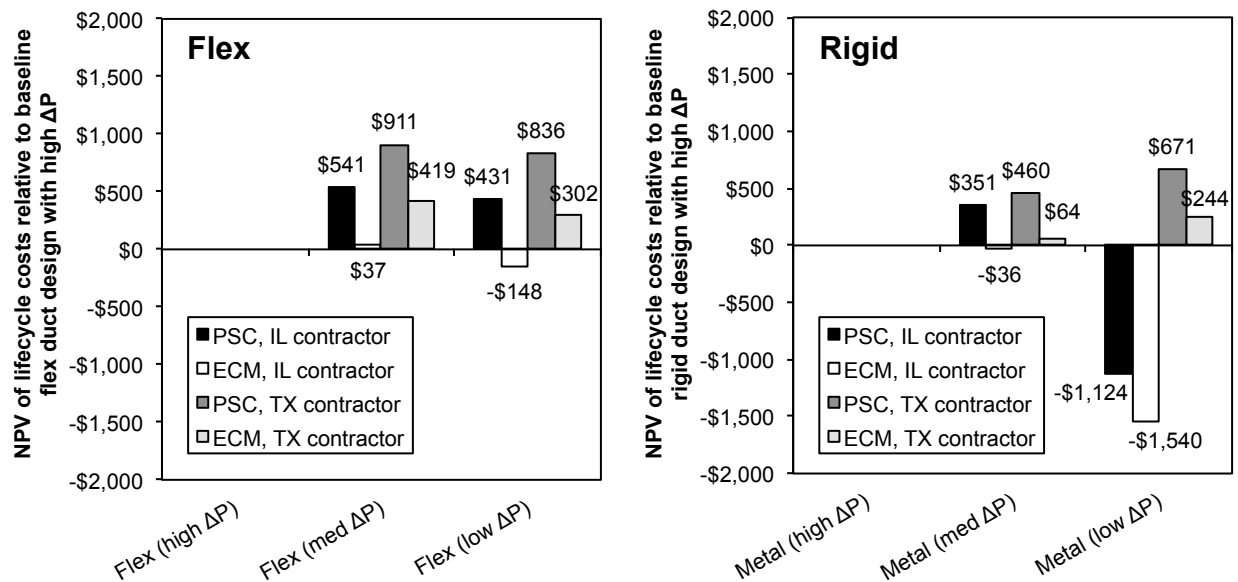

Austin Home: NPV Summary

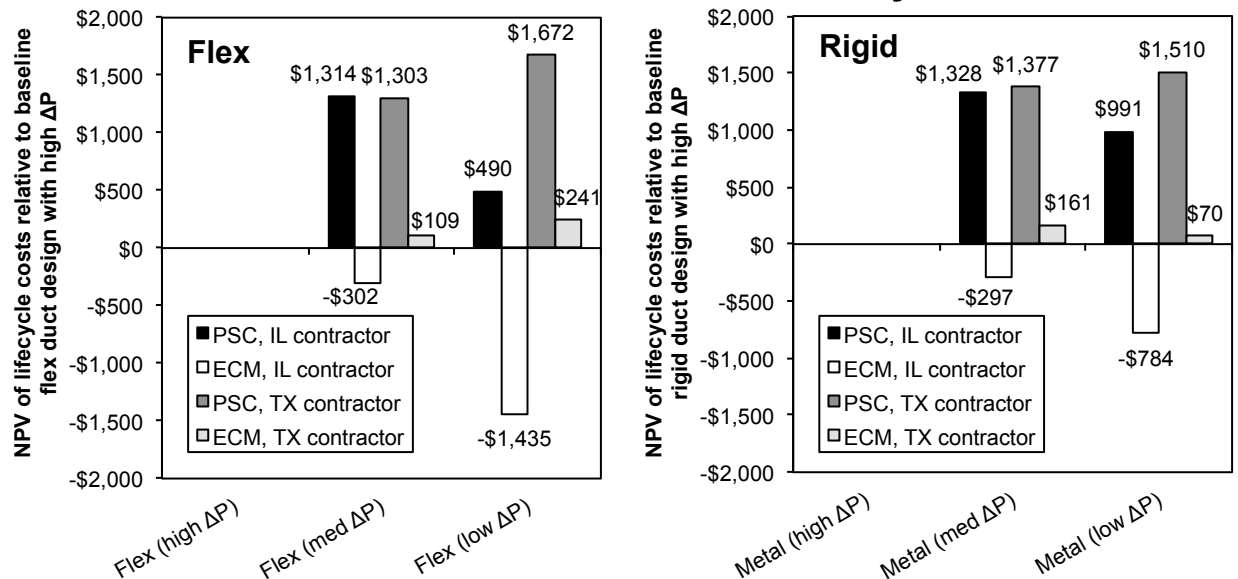

Figure 30. Summary of 15-year NPV analysis for all 32 medium or low pressure duct scenarios compared to their 16 counterpart high pressure designs.

In the Chicago home with flexible ductwork, the lower pressure scenario that provided the greatest life cycle cost savings (highest NPV) relative to the highest pressure scenario was that with a PSC blower operating at medium pressure using the Austin contractor's designs (\$911). The lowest pressure PSC scenario with the Austin contractor's designs yielded the next largest cost savings (\$836). In the same home with rigid ductwork, the lowest pressure PSC scenario with the Austin contractor's designs yielded the greatest life cycle cost savings (highest NPV) (\$671). Three of the four lower pressure PSC scenarios using the Chicago contractor's designs actually yielded excess life cycle costs (as much as \$1540 more), suggesting again that design details and cost estimates play an important role in the life cycle cost impacts of lower pressure duct designs.

In the Austin home with flexible ductwork, the lower pressure scenario that provided the greatest life cycle cost savings relative to the highest pressure scenario was that with a PSC blower operating at the lowest pressure using the Austin contractor's designs (\$1672). The medium pressure PSC scenarios with either contractor's designs provided the next largest savings (around \$1300). Again, results of lower pressure scenarios with the Chicago contractor's designs and cost estimates were more variable, sometimes providing savings (as much as \$1300) and sometimes yielding excess life cycle costs (as much as \$1400). In the same home with rigid sheet metal ductwork, the lowest pressure PSC scenario with the Austin contractor's designs again yielded the greatest life cycle cost savings (\$1510), with the medium pressure scenario and the Austin contractor's designs not far behind (\$1377). Results with the Chicago contractor's estimates were again more variable, with savings as large as \$1328 and excess life cycle costs as high as \$784.

Taken together, these results suggest that either medium or low pressure flex duct systems are generally preferred from a life cycle cost perspective in these two homes with either contractor's designs, particularly if a PSC blower is installed, and that the magnitude (and sometimes direction) of savings will depend largely on individual duct designs and cost estimates. These savings are predicted because the lower pressure designs allow for the HVAC systems to maintain adequate airflow rates and operate for shorter periods of time over the course of a year.

Sensitivity analysis

Changes in a number of assumptions in this work may lead to very different results and conclusions. For example, changes in assumptions for future energy costs, duct leakage fractions, ductwork insulation values, thermostat settings, envelope thermal performance, HVAC equipment efficiency (i.e., SEER for both air-conditioning units, AFUE for the furnace, and HSPF for the heat pump), HVAC equipment and ductwork lifespans, and the location of the ductwork (i.e., moving inside to conditioned space), can all have a large impact on the simulation results. However, it was beyond the scope of this project to systematically vary each parameter individually as would be appropriate for a large suite of Monte Carlo simulations, so we rely primarily on a qualitative discussion of the sensitivity to these important parameters with some quantitative approximations of one particular influence.

For one, if future energy costs for either natural gas or electricity were to increase at a greater rate than what is modeled herein, the predicted annual savings in energy costs for each of the lower pressure duct scenarios would be larger and would thus yield larger life cycle savings relative to the baseline high pressure flex conditions. Depending on the increase in energy costs this could potentially increase the number of scenarios with life cycle cost savings. Similar impacts would be seen if other inputs that affect the absolute amount of energy used for space conditioning were also varied, including higher thermostat settings in the winter, lower thermostat settings in the summer, decreased envelope performance, and decreased HVAC equipment efficiency. Conversely, lower thermostat settings in the winter, higher thermostat settings in the summer, improved envelope performance, increased HVAC equipment efficiency, and moving ducts into conditioned space would all work to decrease annual energy demands and thus make differences between scenarios even smaller, which could potentially decrease the number of scenarios in which positive NPVs are observed.

As an example of the potential of these effects, we explored how the results may vary with one particularly important set of input parameters: HVAC equipment efficiency. The modeled homes relied on SEER 15 air-conditioning units (both homes), a heat pump with 8.5 HSPF (Austin), and a gas furnace with 92.5 AFUE (Chicago). If the efficiency of the air-conditioning units was decreased to SEER 13, the HSPF was decreased to 7.7, and the furnace was decreased to AFUE 80, which are each more in line with code minimums in most locations, then the modeled homes would be expected to use approximately 15% more energy for cooling in both homes and 10% and 16% more energy for heating in the Austin and Chicago homes, respectively, using a simple comparison of nominal COP values. Systems would not run longer because the loads would not change; only the amount of energy required to meet the same loads would change at each time step. This simple linear approximation was verified using only one altered simulation case. Results of this approximation applied to cost analyses of all of the simulation scenarios are shown in Figure 31 again with the high pressure flex duct system as a baseline scenario.

Chicago Home: NPV Summary (lower HVAC efficiency)

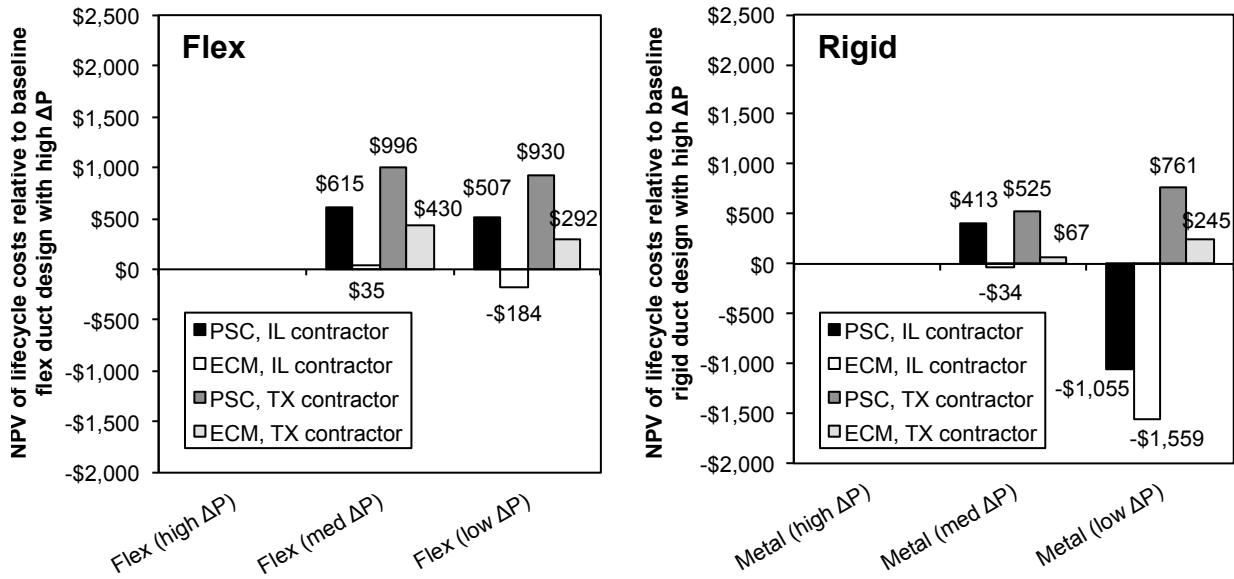

Austin Home: NPV Summary (lower HVAC efficiency)

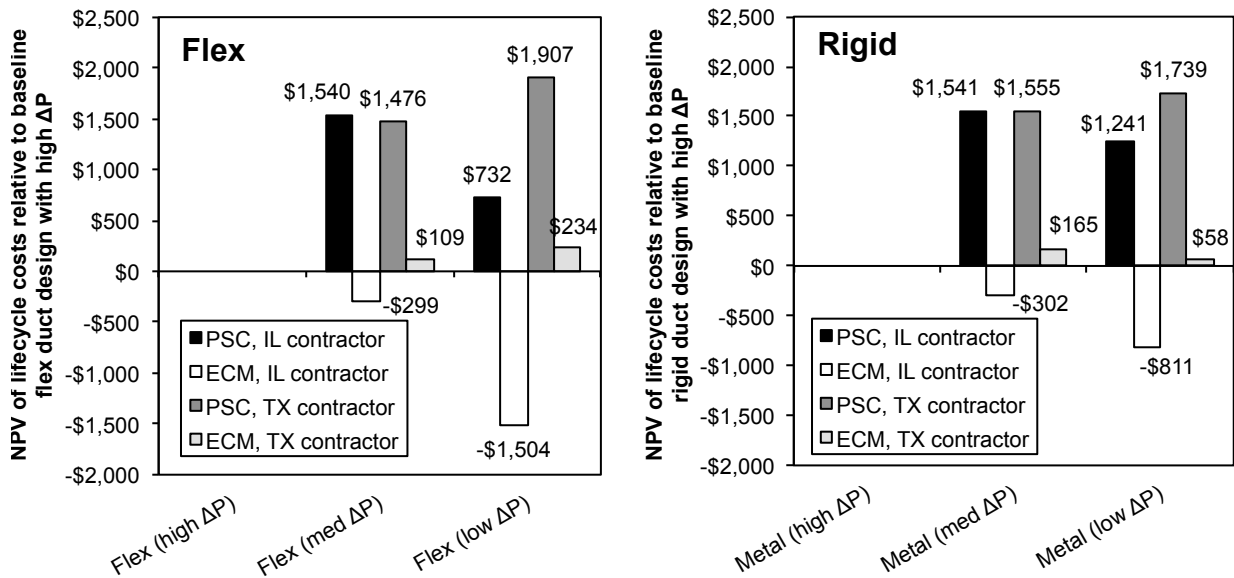
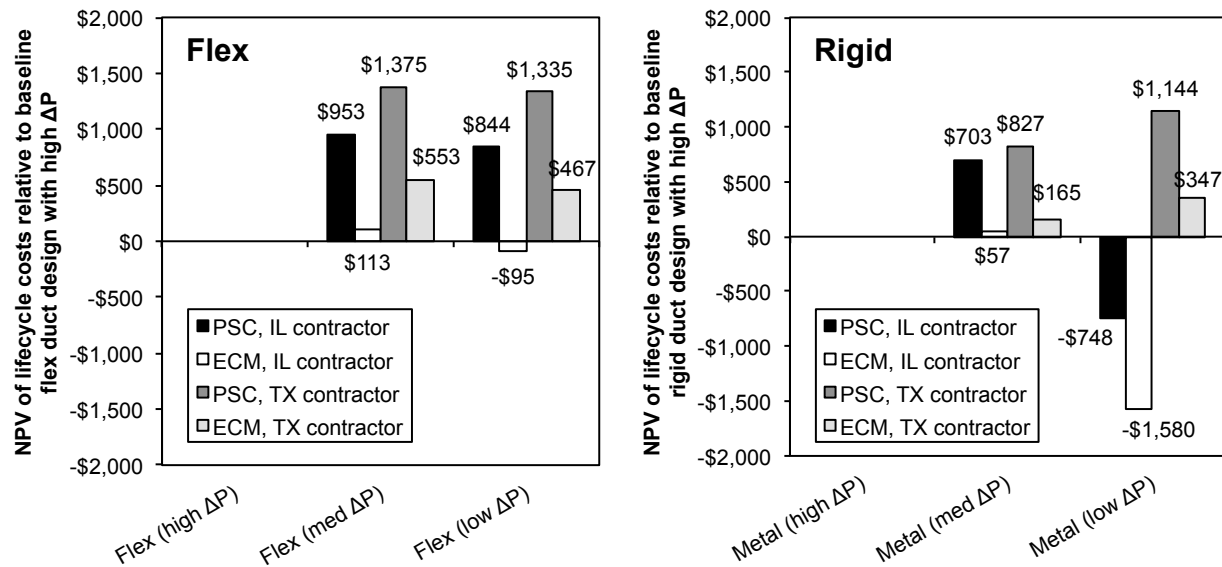

Figure 31. Sensitivity of 15-year NPVs of duct designs for all scenarios compared to high pressure flex assuming lower HVAC equipment efficiency (i.e., SEER 13, 80 AFUE, and 7.7 HSPF).

Using these simple differences, although the magnitude of savings changed by as much as about \$250 in terms of 15-year NPV, the number of simulation cases resulting in life cycle cost savings did not change, suggesting that the summary of results herein is not impacted significantly by these assumptions for input parameters. Other variations in input parameters may have different impacts but are not explored in this work.

A final important assumption to explore is the use of a 15-year life cycle in our NPV calculations. A 15-year timeline was used because although duct systems are expected to last much longer, these simulations rely on accurate assumptions for HVAC equipment efficiency. Typical HVAC equipment lifespans are in the range of 15 years, so it is very likely that in the lifespan of a duct system, some or all HVAC equipment components would be replaced. However, there is no way of knowing what efficiency equipment will be available on the market 15 years from now, let alone what their upfront costs may be. Therefore, we simply explore the sensitivity of our results to the assumption of life cycle length by repeating our analyses with a 30-year life cycle. Results are shown in Figure 32 and summarized in Table 15 and Table 16.

Chicago Home: NPV Summary (30 year)



Austin Home: NPV Summary (30 year)

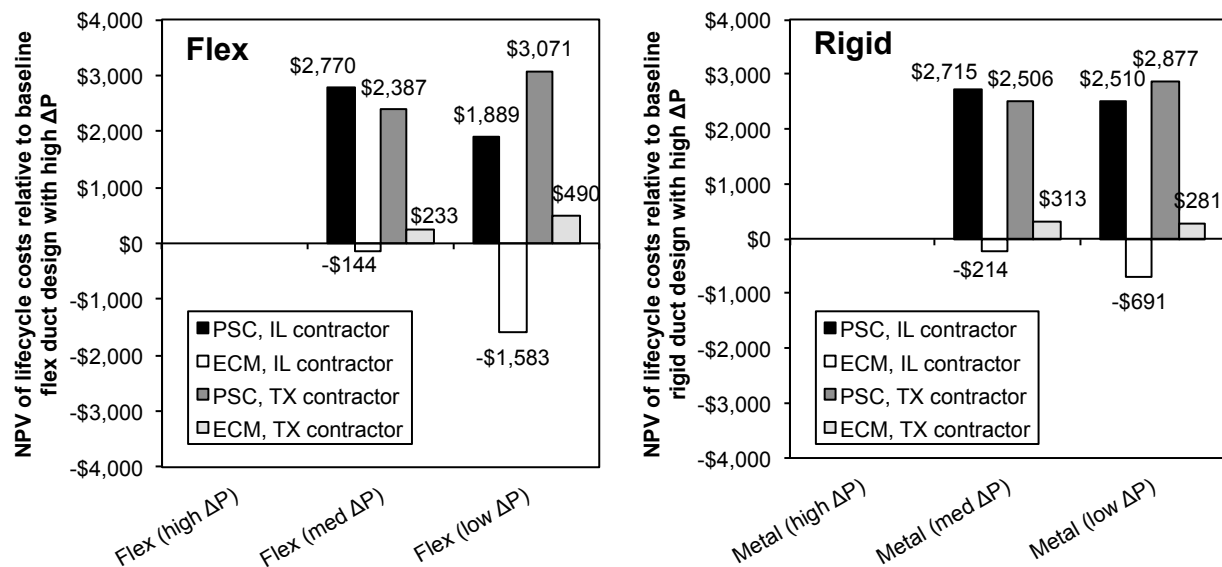

Figure 32. Net present value (NPV) of the life cycle costs of both flex and rigid duct designs over 30-year life relative to the high pressure counterpart designs in each location and with each type of fan installed. The high pressure case refers to 1.1” w.c. of total pressure for the Chicago home and 1.15” w.c. of total pressure for the Austin home. Positive values represent scenarios with lifetime savings.

Adjusting to a 30-year lifespan does not drastically change the direction of most results herein. In fact, only one scenario (the PSC+rigid medium pressure design in the Chicago home using the Chicago contractor’s designs) moved from a net excess cost to a slight net savings. The magnitude of savings did however increase over time for most scenarios. These results suggest that the assumed timeframe does not have a large impact on this analysis in these homes and under all of the underlying assumptions used herein.

Table 15. Summary of 30-year NPV analysis for flex ducts only

			30-year NPV relative to high pressure flex¹	
Home	Contractor	Blower	Flex low	Flex medium
Chicago	IL	PSC	+	+
		ECM	-	+
	TX	PSC	+	+
		ECM	+	+
Austin	IL	PSC	+	+
		ECM	-	-
	TX	PSC	+	+
		ECM	+	+
Number of scenarios w/ savings:			6/8	7/8

¹Positive signs (+) reflect life cycle cost savings. Negative signs (-) reflect excess life cycle costs.

Table 16. Summary of 30-year NPV analysis for rigid ducts only

			30-year NPV relative to high pressure rigid¹	
Home	Contractor	Blower	Rigid low	Rigid medium
Chicago	IL	PSC	-	+
		ECM	-	+
	TX	PSC	+	+
		ECM	+	+
Austin	IL	PSC	+	+
		ECM	-	-
	TX	PSC	+	+
		ECM	+	+
Number of scenarios w/ savings:			5/8	7/8

¹Positive signs (+) reflect life cycle cost savings. Negative signs (-) reflect excess life cycle costs.

Limitations

There are a number of important limitations to this work that should be mentioned. For one, this work was limited to the particular homes, climates, duct designs, cost estimates, and choices of input parameters used herein. Results may not be extrapolated directly to other environments. Second, this work did not capture any changes in system pressures over time; pressures were assumed constant throughout the year. Third, this work assumed that both flexible and rigid sheet metal ductwork have the same likelihood of being installed according to industry quality standards and therefore can meet the specified design pressures. In reality, flexible ductwork materials are more likely to be constricted during construction due to installation with excessive compression, excessive sag, or being pinched by wires and cables. However, these impacts were not captured herein. Fourth, this work focused only on energy consumption impacts and did not explore other factors such as air distribution effectiveness, occupant comfort, indoor air quality, or noise. Finally, this work did not explore differences in equipment reliability and maintenance that may differ across the ductwork materials used or between the two fan types. For example, fans may need to be replaced more often when subjected to excessive static pressures, but we are not aware of accurate ways to estimate replacement times under different operational conditions and thus these impacts remain beyond the scope of this study.

Future work should systematically explore the sensitivity of these results and conclusions to deviations from a number of important input parameters and assumptions used herein.

Conclusions

It is commonly assumed that lower pressure duct systems are preferred for use in central residential heating and air-conditioning systems because they will result in greater airflow rates and cooling and heating capacities with PSC blowers and lower fan power draws with ECM blowers. Results from the 48 annual building energy simulations and life cycle cost analyses using a number of blower types, ductwork materials, and duct designs meeting a range of specified external static pressures in the two model homes described herein suggest the following:

1. Lower airflow rates and heating and cooling capacities caused by excessive system pressures (e.g., total external static pressure of 1.10-1.15" w.c., or 275-288 Pa) introduced by duct designs with high static pressures in the model homes with PSC blowers yielded substantial increases in HVAC energy use compared to the same systems operating with lower pressure duct designs (e.g., total external static pressure of 0.50-0.55" w.c., or 125-138 Pa).
2. HVAC energy impacts of the same systems using ECM blowers were not as large as those using PSC blowers because although ECM blowers draw more power to maintain nearly constant airflow rates and heating and cooling capacities at higher pressure drops, fan power was a small portion of the overall HVAC energy use.
3. When the initial costs of lower pressure duct designs were taken into account over a 15-year or 30-year life cycle, lower pressure duct designs generally yielded life cycle cost savings relative to the highest pressure duct systems, particularly in homes with PSC blowers and particularly when making comparisons with constant ductwork materials (i.e., comparing flex only or rigid only).
4. Lower pressure duct designs combined with ECM blowers can also yield life cycle cost savings over the highest pressure duct designs, although the magnitude of savings was typically lower than with PSC blowers and varied depending on specific duct design details and contractor cost estimates.
5. Specific details in contractor duct designs and cost estimates intended to meet specific external static pressures can have a large influence on the impacts that ductwork designs can have on HVAC energy consumption and total life cycle costs in residences.

Acknowledgements

This work was funded by the Air-Conditioning, Heating, and Refrigeration Institute (AHRI). We are grateful for the AHRI project monitoring committee for their helpful comments throughout the project and for Jon Lemmond and Xudong Wang for their work as project facilitators within AHRI. I would also like to acknowledge Zeineb El Orch for her tireless efforts in performing much of the energy simulations and cost analyses herein and Hailey Kunkel for her work translating duct designs into a format for use in the energy modeling. Finally, I would also like to acknowledge the work of Robert Doornbos at Doornbos Heating and Air Conditioning in Chicago, IL and Chris Henderson at Austin Air Conditioning, Inc., in Austin TX for their work on the duct designs and cost estimates used herein.

References

- Abushakra, B., Walker, I.H., Sherman, M.H., (2002). A study of pressure losses in residential air distribution systems, *in: Proceedings of the 2002 ACEEE Summer Study on Energy Efficiency in Buildings*.
- ANSI/ACCA, (2011a). ANSI/ACCA Manual J: Residential Load Calculations.
- ANSI/ACCA, (2011b). ANSI/ACCA Manual D: Residential Duct Systems.
- ASHRAE, (2004a). Chapter 16: Duct Construction, *in: 2004 ASHRAE Handbook—HVAC Systems and Equipment*. American Society of Heating, Refrigerating and Air-Conditioning Engineers, Inc, Atlanta, GA.
- ASHRAE, (2004b). ASHRAE Standard 152: Method of Test for Determining the Design and Seasonal Efficiencies of Residential Thermal Distribution Systems.
- Brandemuehl, M.J., Gabel, S., Andersen, I., (1993). A Toolkit for Secondary HVAC System Energy Calculation.
- Burdick, A., (2011). Advanced Strategy Guideline: Air Distribution Basics and Duct Design. Prepared for: Building America Building Technologies Program Office of Energy Efficiency and Renewable Energy U.S. Department of Energy.
- DOE, (2005). Test Procedure for Residential Central Air Conditioners and Heat Pumps: Final Rule. Federal Register 70 (195), 59122-59180, Part II. 10 CFR Part 430, Energy Conservation Program for Consumer Products.
- DOE, (2011). Technical Support Document: Energy Efficiency Program for Consumer Products: Residential Central Air Conditioners, Heat Pumps, and Furnaces. Appendix 7-F: Calculation of furnace blower fan energy consumption.
- EIA, (2013). Annual Energy Outlook 2013. Table A8: Electricity supply, disposition, prices, and emissions.
- Francisco, P., Palmiter, L., Davis, B., (1998). Modeling the thermal distribution efficiency of ducts: comparisons to measured results. *Energy and Buildings* 28, 287–97.
- Franco, V., Lutz, J., Lekov, A., Gu, L., (2008). Furnace Blower Electricity: National and Regional Savings Potential, *in: Proceedings of the 2008 ACEEE Summer Study on Energy Efficiency in Buildings*.
- Genteq, (2010). From E to Z: The ECM Textbook.
- Hendron, B., Engebrecht, C., (2010). Building America House Simulation Protocols (No. TP-550-49426). National Renewable Energy Lab (NREL), Golden, CO.
- Kruse, E., Palmiter, L., Francisco, P.W., (2008). Measured Effect of Air Flow and Refrigerant Charge on a High-Performance Heat Pump, *in: Proceedings of the 2008 ACEEE Summer Study on Energy Efficiency in Buildings*. pp. 141–151.
- Lutz, J., Dunham-Whitehead, C., Lekov, A., McMahon, J., (2004). Modeling Energy Consumption of Residential Furnaces and Boilers in U.S. Homes (No. LBNL-53924). Lawrence Berkeley National Laboratory.
- Lutz, J., Franco, V., Lekov, A., Wong-Parodi, G., (2006). BPM Motors in Residential Gas Furnaces: What are the Savings?, *in: Proceedings of the 2006 ACEEE Summer Study on Energy Efficiency in Buildings*.
- Nassif, N., (2012). The impact of air filter pressure drop on the performance of typical air-conditioning systems. *Building Simulation* 5, 345–350.
- Neme, C., Proctor, J., Nadel, S., (1999). Energy Savings Potential From Addressing Residential Air-conditioner and Heat Pump Installation Problems.

- Palmiter, L., Kim, J.-H., Larson, B., Francisco, P.W., Groll, E.A., Braun, J.E., (2011). Measured effect of airflow and refrigerant charge on the seasonal performance of an air-source heat pump using R-410A. *Energy and Buildings* 43, 1802–1810.
- Parker, D., Fairey, P., Gu, L., (1993). Simulation of the effects of duct leakage and heat transfer on residential space-cooling energy use. *Energy and Buildings* 20, 97–113.
- Parker, D.S., Sherwin, J.R., Raustad, R.A., Shirey, D.B., (1997). Impact of evaporator coil airflow in residential air-conditioning systems. *ASHRAE Transactions* 103, 395–405.
- Payne, W.V., Yoon, S.H., Domanski, P.A., (2010). Residential Heat Pump Heating Performance with Single Faults Imposed. Presented at the International Refrigeration and Air Conditioning Conference at Purdue, pp. 1–8.
- Proctor, J., Chitwood, R., Wilcox, B., (2011). Efficiency characteristics and opportunities for new California homes (No. CEC-500-2012-062). California Energy Commission.
- Proctor, J., Parker, D., (2000). Hidden power drains: residential heating and cooling fan power demand, in: *Proceedings of the 2000 ACEEE Summer Study on Energy Efficiency in Buildings*. pp. 225–234.
- Rodriguez, A.G., O’Neal, D., Davis, M., Kondepudi, S., (1996). Effect of reduced evaporator airflow on the high temperature performance of air conditioners. *Energy and Buildings* 24, 195–201.
- Rushing, A.S., Kneifel, J.D., Lippiatt, B.C., (2012). Energy Price Indices and Discount Factors for Life-Cycle Cost Analysis – 2012: Annual Supplement to NIST Handbook 135 and NBS Special Publication 709 (No. NISTIR 85-3273-27). National Institute of Standards and Technology (NIST).
- Sachs, H., Kubo, T., Smith, S., Scott, K., (2002). Residential HVAC fans and motors are bigger than refrigerators, in: *Proceedings of the 2002 ACEEE Summer Study on Energy Efficiency in Buildings*. pp. 261–272.
- Sanders, D.R., Manfredo, M.R., Boris, K., (2008). Accuracy and efficiency in the U.S. Department of Energy’s short-term supply forecasts. *Energy Economics* 30, 1192–1207.
- Shen, B., Braun, J.E., Groll, E.A., (2011). The Impact of Refrigerant Charge, Airflow, and Expansion Devices on the Measured Performance of an Air-Source Heat Pump—Part I. *ASHRAE Transactions* 117, ML–11–006.
- Stephens, B., (2014). GitHub repository: AHRI Duct Design.
- Stephens, B., Novoselac, A., Siegel, J.A., (2010). The effects of filtration on pressure drop and energy consumption in residential HVAC systems. *HVAC&R Research* 16, 273–294.
- Stephens, B., Siegel, J., Novoselac, A., (2010a). Energy implications of filtration in residential and light-commercial construction. ASHRAE Research Project-1299. American Society of Heating, Refrigerating, and Air-Conditioning Engineers.
- Stephens, B., Siegel, J.A., Novoselac, A., (2010b). Energy implications of filtration in residential and light-commercial buildings (RP-1299). *ASHRAE Transactions* 116, 346–357.
- Stephens, B., Siegel, J.A., Novoselac, A., (2011). Operational characteristics of residential and light-commercial air-conditioning systems in a hot and humid climate zone. *Build. Environ.* 46, 1972–1983.
- Walker, I.S., (2006). Residential Furnace Blower Performance (No. LBNL-61467). Lawrence Berkeley National Laboratory.
- Walker, I.S., Degenetais, G., Seigel, J.A., (2002). Simulations of sizing and comfort improvements for residential forced-air heating and cooling systems. Lawrence Berkeley National Laboratory, Berkeley, CA.

- Walker, I.S., Dickerhoff, D.J., Faulkner, D., Turner, W.J.N., (2012). Energy Implications of In-Line Filtration in California (No. LBNL--6143E). Lawrence Berkeley National Laboratory, Berkeley, CA.
- Wilcox, B., Proctor, J., Chitwood, R., Nittler, K., (2006). Furnace Fan Watt Draw and Air Flow in Cooling and Air Distribution Modes. 2008 California Building Energy Efficiency Standards.
- Wilson, E.J.H., McNeill, J.S., Zhai, J., Krarti, M., (2013). A Parametric Study of Energy Savings from Cleaning Coils and Filters in Constant Air Volume HVAC Systems. *HVAC&R Research* in press.

Appendix: Duct designs from contractors

HEATING & AIR CONDITIONING
by DOORNBOS

February 14, 2013

Dr. Brent Stephens
Illinois Institute of Technology
3201 So Dearborn (AM-212)
Chicago, Illinois 60616-3089

Dear Brent:

Thank you for the opportunity to participate in this project.

I have enclosed notes regarding the equipment for the Midwest home along with 12 designs, 6 @ 1150 CFM and 6 @1307 CFM. I used an upflow configuration for the sheet metal duct systems and a horizontal configuration for the flex duct systems.

I chose radial duct layouts for the flex duct systems. I did this for two reasons; height would be restricted in the basement by using large round duct work and in reality the labor to install a radial duct system is less than a flex trunk system with junction boxes.

I have also enclosed 6 designs for the Southern Home and a copy of the invoice.

Please review my paper work and let me know if you need anything else.

Respectfully,



Robert Doornbos

Four Generations of Good Business

www.doornbos.com

11310 S. Cicero Avenue • Alsip, Illinois 60803 • Phone (708) 423-9580 • Fax (708) 423-7361

HEATING & AIR CONDITIONING by DOORNBOS

February 14, 2013

Dr. Brent Stephens
Illinois Institute of Technology
3201 So Dearborn (AM-212)
Chicago, Illinois 60616-3089

Midwest Home – Notes

Amana model AMVC950704CX upflow/horizontal 95% AFUE 2-stage variable speed furnace. (ECM)

Amana model ASXC160361, 16 S.E.E.R., 12.5 E.E.R., 2-stage condensing unit.

Amana model CAPF3743 upflow evaporator coil with TXV and insulated cabinet.
AHRI# 4415292

Amana model CHPF3743 horizontal evaporator coil with TXV and insulated cabinet.
AHRI#3655168

A.H.R.I. rated at 65,300 BTU/H heating output with 34,000 BTU/H total cooling capacity.

Hart & Cooley model 411 floor supply registers
Hart & Cooley model 672 side wall return grills
Southwark model AT63 manual volume dampers

Wet coil	.16
Supply Register	.03
Return Grill	.03
Volume Damper	.03
Standard 1" fiberglass filter	<u>.1</u>
Component Pressure loss	.35

Various Duct Designs	.15	.45	.75
----------------------	-----	-----	-----

Four Generations of Good Business

www.doornbos.com

11310 S. Cicero Avenue • Alsip, Illinois 60803 • Phone (708) 423-9580 • Fax (708) 423-7361

HEATING & AIR CONDITIONING by DOORNBOS

February 6, 2013

Dr. Brent Stephens
Illinois Institute of Technology
3201 So Dearborn (AM-212)
Chicago, Illinois 60616-3089

Re: AHRI Project
Midwest Home

Scope of Work

- Amana AMVC950704C gas furnace
- Amana ASXC16036 condensing unit
- Amana cased up flow coil with TXV
- Controls and low voltage control wiring
- Hart & Cooley floor supply registers and sidewall return grills
- Precast concrete slab and isolators set on a granular base
- Condensate drain piping to nearby floor drain
- Refrigerant piping and insulation
- Duct work distribution per the attached drawing including sealing and insulating
- Start-up and adjust
- Standard manufacturer's warranty
- One year warranty service
- All work shall be done in a neat, workmanlike manner, left clean and free of defects

Total installed price excluding permit fees

Sheet Metal Duct @.15"	\$17,250.00
Sheet Metal Duct @.45"	\$15,750.00
Sheet Metal Duct @.75"	\$15,600.00
Flex Duct @.15"	\$11,750.00
Flex Duct @.45"	\$11,650.00
Flex Duct @.75"	\$11,600.00

Four Generations of Good Business

www.doornbos.com

11310 S. Cicero Avenue • Alsip, Illinois 60803 • Phone (708) 423-9580 • Fax (708) 423-7361

Duct System Summary

Entire House

Doornbos Heating and Air Conditioning, Inc.

Job: Anderson Plan #2997

Date: February 11, 2012

By: R Doornbos

Plan: 2997

11310 South Cicero Avenue, Alsip, IL 60803 Phone: 708 423 9580 Fax: 708 423 7361 Email: ruhotorcold@gmail.com Web: www.doornbos.com

Project Information

For: Midwest Home, Illinois Institute of Technology
3201 South Dearborn, Chicago, IL 60616

	Heating	Cooling
External static pressure	0.50 in H2O	0.50 in H2O
Pressure losses	0.35 in H2O	0.35 in H2O
Available static pressure	0.15 in H2O	0.15 in H2O
Supply / return available pressure	0.04 / 0.11 in H2O	0.04 / 0.11 in H2O
Lowest friction rate	0.034 in/100ft	0.034 in/100ft
Actual air flow	1150 cfm	1150 cfm
Total effective length (TEL)		447 ft

Supply Branch Detail Table

Name	Design (Btuh)	Htg (cfm)	Clg (cfm)	Design FR	Diam (in)	H x W (in)	Duct Matl	Actual Ln (ft)	Ftg.Eqv Ln (ft)	Trunk
Bath	h 1465	36	16	0.034	6.0	0x0	VIFx	45.5	85.0	
Bedroom 1	c 3095	104	114	0.034	10.0	0x0	VIFx	45.5	85.0	
Bedroom 2	h 4576	113	107	0.034	10.0	0x0	VIFx	45.5	85.0	
Bedroom 3	h 4382	108	106	0.034	10.0	0x0	VIFx	45.5	85.0	
Dining Room	h 5248	130	112	0.034	10.0	0x0	VIFx	45.5	85.0	
Family Room	c 2972	68	109	0.034	10.0	0x0	VIFx	45.5	85.0	
Family Room-A	c 2972	68	109	0.034	10.0	0x0	VIFx	45.5	85.0	
Foyer/Hallway	h 5423	134	91	0.034	10.0	0x0	VIFx	45.5	85.0	
Kitchen/Dinette	c 3067	90	112	0.034	10.0	0x0	VIFx	45.5	85.0	
Kitchen/Dinette-A	c 3067	90	112	0.034	10.0	0x0	VIFx	45.5	85.0	
Laundry	h 3672	91	62	0.034	8.0	0x0	VIFx	45.5	85.0	
Master Bath	h 4769	118	100	0.034	10.0	0x0	VIFx	45.5	85.0	

Return Branch Detail Table

Name	Grill Size (in)	Htg (cfm)	Clg (cfm)	TEL (ft)	Design FR	Veloc (fpm)	Diam (in)	H x W (in)	Stud/Joist Opening (in)	Duct Matl	Trunk
rb1	0x0	180	225	316.0	0.034	286	12.0	0x 0		VIFx	
rb2	0x0	270	309	316.0	0.034	289	14.0	0x 0		VIFx	
rb3	0x0	258	229	316.0	0.034	328	12.0	0x 0		VIFx	
rb4	0x0	113	107	316.0	0.034	207	10.0	0x 0		VIFx	
rb5	0x0	108	106	316.0	0.034	199	10.0	0x 0		VIFx	
rb6	0x0	130	112	316.0	0.034	238	10.0	0x 0		VIFx	
rb8	0x0	91	62	316.0	0.034	260	8.0	0x 0		VIFx	

Bold/italic values have been manually overridden

Duct System Summary

Entire House

Doornbos Heating and Air Conditioning, Inc.

Job: Anderson Plan #2997
Date: February 11, 2012
By: R Doornbos
Plan: 2997

11310 South Cicero Avenue, Alsip, IL 60803 Phone: 708 423 9580 Fax: 708 423 7361 Email: ruhotorcold@gmail.com Web: www.doornbos.com

Project Information

For: Midwest Home, Illinois Institute of Technology
3201 South Dearborn, Chicago, IL 60616

	Heating	Cooling
External static pressure	0.80 in H2O	0.80 in H2O
Pressure losses	0.35 in H2O	0.35 in H2O
Available static pressure	0.45 in H2O	0.45 in H2O
Supply / return available pressure	0.13 / 0.32 in H2O	0.13 / 0.32 in H2O
Lowest friction rate	0.101 in/100ft	0.101 in/100ft
Actual air flow	1150 cfm	1150 cfm
Total effective length (TEL)		447 ft

Supply Branch Detail Table

Name	Design (Btuh)	Htg (cfm)	Clg (cfm)	Design FR	Diam (in)	H x W (in)	Duct Matl	Actual Ln (ft)	Ftg.Eqv Ln (ft)	Trunk
Bath	h 1465	36	16	0.101	6.0	0x0	VIFx	45.5	85.0	
Bedroom 1	c 3095	104	114	0.101	7.0	0x0	VIFx	45.5	85.0	
Bedroom 2	h 4576	113	107	0.101	7.0	0x0	VIFx	45.5	85.0	
Bedroom 3	h 4382	108	106	0.101	7.0	0x0	VIFx	45.5	85.0	
Dining Room	h 5248	130	112	0.101	8.0	0x0	VIFx	45.5	85.0	
Family Room	c 2972	68	109	0.101	7.0	0x0	VIFx	45.5	85.0	
Family Room-A	c 2972	68	109	0.101	7.0	0x0	VIFx	45.5	85.0	
Foyer/Hallway	h 5423	134	91	0.101	8.0	0x0	VIFx	45.5	85.0	
Kitchen/Dinette	c 3067	90	112	0.101	7.0	0x0	VIFx	45.5	85.0	
Kitchen/Dinette-A	c 3067	90	112	0.101	7.0	0x0	VIFx	45.5	85.0	
Laundry	h 3672	91	62	0.101	7.0	0x0	VIFx	45.5	85.0	
Master Bath	h 4769	118	100	0.101	8.0	0x0	VIFx	45.5	85.0	

Return Branch Detail Table

Name	Grill Size (in)	Htg (cfm)	Clg (cfm)	TEL (ft)	Design FR	Veloc (fpm)	Diam (in)	H x W (in)	Stud/Joist Opening (in)	Duct Matl	Trunk
rb1	0x0	180	225	316.0	0.101	412	10.0	0x 0		VIFx	
rb2	0x0	270	309	316.0	0.101	394	12.0	0x 0		VIFx	
rb3	0x0	258	229	316.0	0.101	472	10.0	0x 0		VIFx	
rb4	0x0	113	107	316.0	0.101	423	7.0	0x 0		VIFx	
rb5	0x0	108	106	316.0	0.101	405	7.0	0x 0		VIFx	
rb6	0x0	130	112	316.0	0.101	372	8.0	0x 0		VIFx	
rb8	0x0	91	62	316.0	0.101	340	7.0	0x 0		VIFx	

Bold/italic values have been manually overridden

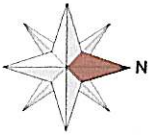

Level 1

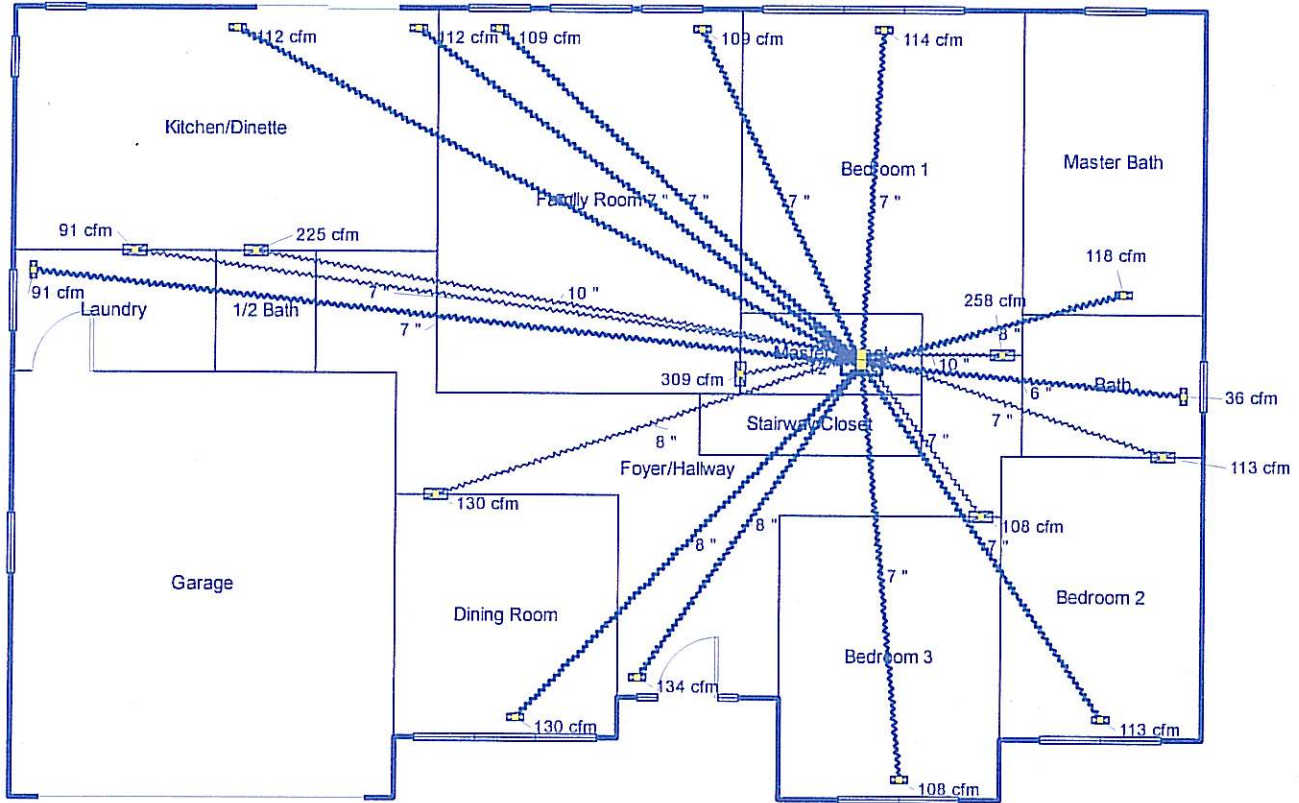

Job #: Anderson Plan #2997
Performed by R Doornbos for:
Midwest Home
3201 South Dearborn
Chicago, IL 60616

Doornbos Heating and Air Condit...
11310 South Cicero Avenue
Alsip, IL 60803
Phone: 708 423 9580 Fax: 708 423 7361
www.doornbos.com ruhotorcold@gmail.com

Scale: 1 : 114
Page 1
Right-Suite® Universal 2012
12.1.04 RSU17924
2013-Feb-12 10:53:55
...htsoft HVAC\Brent Stephens 1.rup

Duct System Summary

Entire House

Doornbos Heating and Air Conditioning, Inc.

Job: Anderson Plan #2997
Date: February 11, 2012
By: R Doornbos
Plan: 2997

11310 South Cicero Avenue, Alsip, IL 60803 Phone: 708 423 9580 Fax: 708 423 7361 Email: ruhotorcold@gmail.com Web: www.doornbos.com

Project Information

For: Midwest Home, Illinois Institute of Technology
3201 South Dearborn, Chicago, IL 60616

	Heating	Cooling
External static pressure	1.10 in H2O	1.10 in H2O
Pressure losses	0.35 in H2O	0.35 in H2O
Available static pressure	0.75 in H2O	0.75 in H2O
Supply / return available pressure	0.22 / 0.53 in H2O	0.22 / 0.53 in H2O
Lowest friction rate	0.168 in/100ft	0.168 in/100ft
Actual air flow	1150 cfm	1150 cfm
Total effective length (TEL)		447 ft

Supply Branch Detail Table

Name	Design (Btuh)	Htg (cfm)	Clg (cfm)	Design FR	Diam (in)	H x W (in)	Duct Matl	Actual Ln (ft)	Ftg.Eqv Ln (ft)	Trunk
Bath	h 1465	36	16	0.168	6.0	0x0	VIFx	45.5	85.0	
Bedroom 1	c 3095	104	114	0.168	7.0	0x0	VIFx	45.5	85.0	
Bedroom 2	h 4576	113	107	0.168	7.0	0x0	VIFx	45.5	85.0	
Bedroom 3	h 4382	108	106	0.168	7.0	0x0	VIFx	45.5	85.0	
Dining Room	h 5248	130	112	0.168	7.0	0x0	VIFx	45.5	85.0	
Family Room	c 2972	68	109	0.168	7.0	0x0	VIFx	45.5	85.0	
Family Room-A	c 2972	68	109	0.168	7.0	0x0	VIFx	45.5	85.0	
Foyer/Hallway	h 5423	134	91	0.168	7.0	0x0	VIFx	45.5	85.0	
Kitchen/Dinette	c 3067	90	112	0.168	7.0	0x0	VIFx	45.5	85.0	
Kitchen/Dinette-A	c 3067	90	112	0.168	7.0	0x0	VIFx	45.5	85.0	
Laundry	h 3672	91	62	0.168	6.0	0x0	VIFx	45.5	85.0	
Master Bath	h 4769	118	100	0.168	7.0	0x0	VIFx	45.5	85.0	

Return Branch Detail Table

Name	Grill Size (in)	Htg (cfm)	Clg (cfm)	TEL (ft)	Design FR	Veloc (fpm)	Diam (in)	H x W (in)	Stud/Joist Opening (in)	Duct Matl	Trunk
rb1	0x0	180	225	316.0	0.168	412	10.0	0x 0		VIFx	
rb2	0x0	270	309	316.0	0.168	567	10.0	0x 0		VIFx	
rb3	0x0	258	229	316.0	0.168	472	10.0	0x 0		VIFx	
rb4	0x0	113	107	316.0	0.168	423	7.0	0x 0		VIFx	
rb5	0x0	108	106	316.0	0.168	405	7.0	0x 0		VIFx	
rb6	0x0	130	112	316.0	0.168	485	7.0	0x 0		VIFx	
rb8	0x0	91	62	316.0	0.168	462	6.0	0x 0		VIFx	

Bold/italic values have been manually overridden

Duct System Summary

Entire House

Doornbos Heating and Air Conditioning, Inc.

Job: Anderson Plan #2997
Date: February 11, 2012
By: R Doombos
Plan: 2997

11310 South Cicero Avenue, Alsip, IL 60803 Phone: 708 423 9580 Fax: 708 423 7361 Email: ruhotorcold@gmail.com Web: www.doombos.com

Project Information

For: Midwest Home, Illinois Institute of Technology
3201 South Dearborn, Chicago, IL 60616

	Heating	Cooling
External static pressure	0.50 in H2O	0.50 in H2O
Pressure losses	0.35 in H2O	0.35 in H2O
Available static pressure	0.15 in H2O	0.15 in H2O
Supply / return available pressure	0.04 / 0.11 in H2O	0.04 / 0.11 in H2O
Lowest friction rate	0.034 in/100ft	0.034 in/100ft
Actual air flow	1150 cfm	1150 cfm
Total effective length (TEL)		447 ft

Supply Branch Detail Table

Name	Design (Btuh)	Htg (cfm)	Clg (cfm)	Design FR	Diam (in)	H x W (in)	Duct Matl	Actual Ln (ft)	Ftg.Eqv Ln (ft)	Trunk
Bath	h 1465	36	16	0.043	6.0	0x0	ShMt	17.5	85.0	st1B
Bedroom 1	c 3095	104	114	0.036	8.0	0x0	ShMt	17.5	105.0	st1
Bedroom 2	h 4576	113	107	0.049	7.0	0x0	ShMt	29.5	60.0	st1
Bedroom 3	h 4382	108	106	0.047	7.0	0x0	ShMt	22.5	70.0	st1
Dining Room	h 5248	130	112	0.042	8.0	0x0	ShMt	34.5	70.0	st2
Family Room	c 2972	68	109	0.046	7.0	0x0	ShMt	34.5	60.0	st2
Family Room-A	c 2972	68	109	0.042	8.0	0x0	ShMt	24.5	80.0	st2
Foyer/Hallway	h 5423	134	91	0.043	8.0	0x0	ShMt	26.5	75.0	st2
Kitchen/Dinette	c 3067	90	112	0.037	8.0	0x0	ShMt	47.5	70.0	st2A
Kitchen/Dinette-A	c 3067	90	112	0.037	8.0	0x0	ShMt	38.5	80.0	st2A
Laundry	h 3672	91	62	0.034	7.0	0x0	ShMt	45.5	85.0	st2B
Master Bath	h 4769	118	100	0.051	8.0	0x0	ShMt	16.5	70.0	st1A

Supply Trunk Detail Table

Name	Trunk Type	Htg (cfm)	Clg (cfm)	Design FR	Veloc (fpm)	Diam (in)	H x W (in)	Duct Material	Trunk
st1B	Peak AVF	36	16	0.043	163	4.7	8 x 4	ShtMetl	st1A
st1A	Peak AVF	154	116	0.043	347	8.1	8 x 8	ShtMetl	st1
st1	Peak AVF	479	442	0.036	479	12.9	8 x 18	ShtMetl	
st2	Peak AVF	671	708	0.034	490	15.1	8 x 26	ShtMetl	
st2A	Peak AVF	271	287	0.034	369	10.8	8 x 14	ShtMetl	st2
st2B	Peak AVF	91	62	0.034	204	7.0	8 x 8	ShtMetl	st2A

Bold/italic values have been manually overridden

Return Branch Detail Table

Name	Grill Size (in)	Htg (cfm)	Clg (cfm)	TEL (ft)	Design FR	Veloc (fpm)	Diam (in)	H x W (in)	Stud/Joist Opening (in)	Duct Matl	Trunk
rb3	0x0	258	229	230.0	0.046	472	10.0	0x 0		ShMt	rt2
rb8	0x0	91	62	227.0	0.047	340	7.0	0x 0		ShMt	rt3B
rb1	0x0	180	225	316.0	0.034	412	10.0	0x 0		ShMt	rt3A
rb2	0x0	270	309	140.0	0.076	567	10.0	0x 0		ShMt	rt3
rb4	0x0	113	107	203.0	0.052	423	7.0	0x 0		ShMt	rt2A
rb5	0x0	108	106	147.0	0.072	405	7.0	0x 0		ShMt	rt2
rb6	0x0	130	112	171.0	0.062	372	8.0	0x 0		ShMt	rt3

Return Trunk Detail Table

Name	Trunk Type	Htg (cfm)	Clg (cfm)	Design FR	Veloc (fpm)	Diam (in)	H x W (in)	Duct Material	Trunk
rt1	Peak AVF	1150	1150	0.034	518	18.1	8 x 40	ShtMetl	
rt3A	Peak AVF	271	287	0.034	369	10.8	8 x 14	ShtMetl	rt3
rt3B	Peak AVF	91	62	0.047	204	6.5	8 x 8	ShtMetl	rt3A
rt2A	Peak AVF	113	107	0.052	423	7.0	0 x 0	ShtMetl	rt2
rt2	Peak AVF	479	442	0.046	539	12.2	8 x 16	ShtMetl	rt1
rt3	Peak AVF	671	708	0.034	490	15.1	8 x 26	ShtMetl	rt1



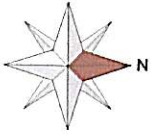

Level 1

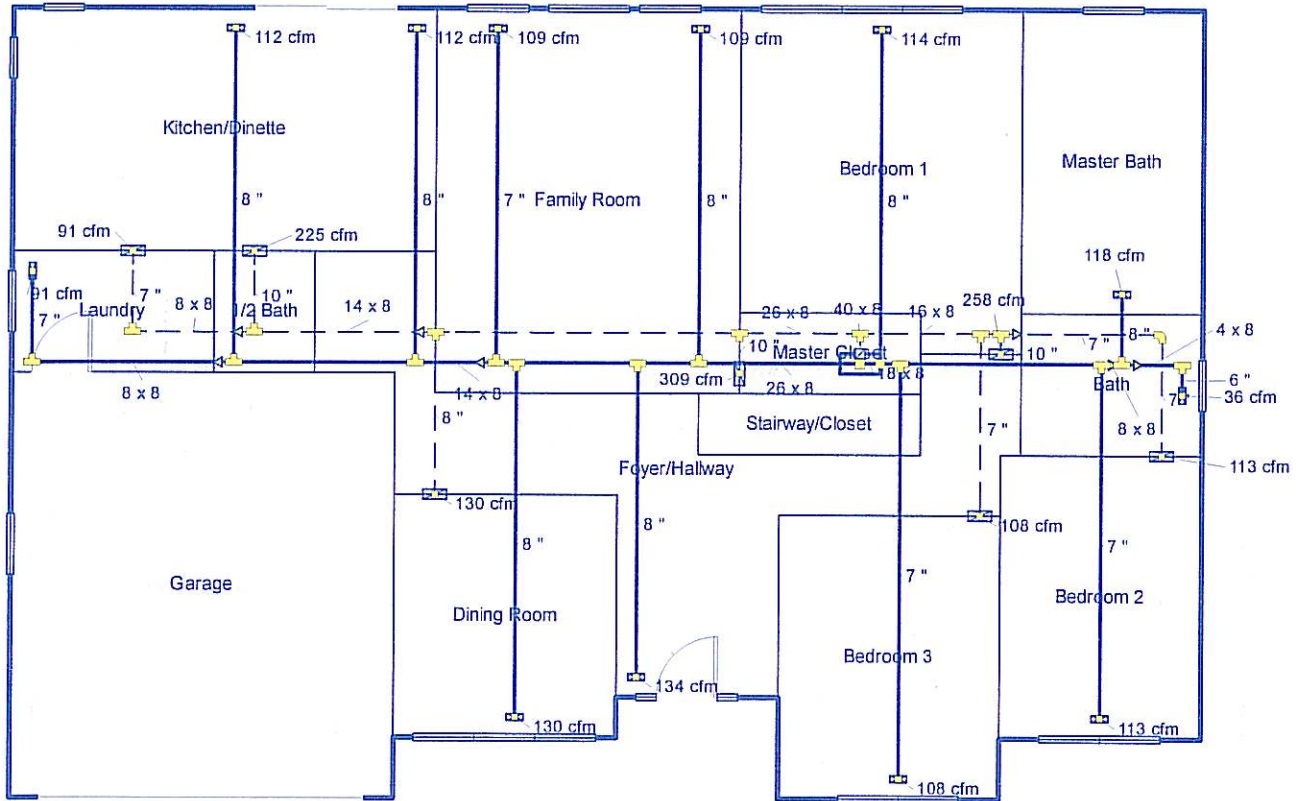

Job #: Anderson Plan #2997
Performed by R Doornbos for:
Midwest Home
3201 South Dearborn
Chicago, IL 60616

Doornbos Heating and Air Condit...
11310 South Cicero Avenue
Alsip, IL 60803
Phone: 708 423 9580 Fax: 708 423 7361
www.doornbos.com ruhotorcold@gmail.com

Scale: 1 : 114
Page 1
Right-Suite® Universal 2012
12.1.04 RSU17924
2013-Feb-12 09:43:20
...htsoft HVAC\Brent Stephens 1.rup

Duct System Summary

Entire House

Doornbos Heating and Air Conditioning, Inc.

Job: Anderson Plan #2997

Date: February 11, 2012

By: R Doornbos

Plan: 2997

11310 South Cicero Avenue, Alsip, IL 60803 Phone: 708 423 9580 Fax: 708 423 7361 Email: ruhotorcold@gmail.com Web: www.doornbos.com

Project Information

For: Midwest Home, Illinois Institute of Technology
3201 South Dearborn, Chicago, IL 60616

Typical

	Heating	Cooling
External static pressure	0.80 in H2O	0.80 in H2O
Pressure losses	0.35 in H2O	0.35 in H2O
Available static pressure	0.45 in H2O	0.45 in H2O
Supply / return available pressure	0.13 / 0.32 in H2O	0.13 / 0.32 in H2O
Lowest friction rate	0.101 in/100ft	0.101 in/100ft
Actual air flow	1150 cfm	1150 cfm
Total effective length (TEL)	447 ft	

Supply Branch Detail Table

Name	Design (Btuh)	Htg (cfm)	Clg (cfm)	Design FR	Diam (in)	H x W (in)	Duct Matl	Actual Ln (ft)	Ftg.Eqv Ln (ft)	Trunk
Bath	h 1465	36	16	0.128	4.0	0x0	ShMt	17.5	85.0	st1B
Bedroom 1	c 3095	104	114	0.107	6.0	0x0	ShMt	17.5	105.0	st1
Bedroom 2	h 4576	113	107	0.147	6.0	0x0	ShMt	29.5	60.0	st1
Bedroom 3	h 4382	108	106	0.142	6.0	0x0	ShMt	22.5	70.0	st1
Dining Room	h 5248	130	112	0.126	7.0	0x0	ShMt	34.5	70.0	st2
Family Room	c 2972	68	109	0.139	6.0	0x0	ShMt	34.5	60.0	st2
Family Room-A	c 2972	68	109	0.126	6.0	0x0	ShMt	24.5	80.0	st2
Foyer/Hallway	h 5423	134	91	0.130	7.0	0x0	ShMt	26.5	75.0	st2
Kitchen/Dinette	c 3067	90	112	0.112	6.0	0x0	ShMt	47.5	70.0	st2A
Kitchen/Dinette-A	c 3067	90	112	0.111	6.0	0x0	ShMt	38.5	80.0	st2A
Laundry	h 3672	91	62	0.101	6.0	0x0	ShMt	45.5	85.0	st2B
Master Bath	h 4769	118	100	0.152	6.0	0x0	ShMt	16.5	70.0	st1A

Supply Trunk Detail Table

Name	Trunk Type	Htg (cfm)	Clg (cfm)	Design FR	Veloc (fpm)	Diam (in)	H x W (in)	Duct Material	Trunk
st1B	Peak AVF	36	16	0.128	163	3.8	8 x 4	ShtMetl	st1A
st1A	Peak AVF	154	116	0.128	347	6.5	8 x 8	ShtMetl	st1
st1	Peak AVF	479	442	0.107	719	10.3	8 x 12	ShtMetl	
st2	Peak AVF	671	708	0.101	796	12.1	8 x 16	ShtMetl	
st2A	Peak AVF	271	287	0.101	645	8.6	8 x 8	ShtMetl	st2
st2B	Peak AVF	91	62	0.101	408	5.6	8 x 4	ShtMetl	st2A

Bold/italic values have been manually overridden

Return Branch Detail Table

Name	Grill Size (in)	Htg (cfm)	Clg (cfm)	TEL (ft)	Design FR	Veloc (fpm)	Diam (in)	H x W (in)	Stud/Joist Opening (in)	Duct Matl	Trunk
rb3	0x0	258	229	230.0	0.138	472	10.0	0x 0		ShMt	rt2
rb8	0x0	91	62	227.0	0.140	462	6.0	0x 0		ShMt	rt3B
rb1	0x0	180	225	316.0	0.101	644	8.0	0x 0		ShMt	rt3A
rb2	0x0	270	309	140.0	0.227	567	10.0	0x 0		ShMt	rt3
rb4	0x0	113	107	203.0	0.157	576	6.0	0x 0		ShMt	rt2A
rb5	0x0	108	106	147.0	0.217	552	6.0	0x 0		ShMt	rt2
rb6	0x0	130	112	171.0	0.186	661	6.0	0x 0		ShMt	rt3

Return Trunk Detail Table

Name	Trunk Type	Htg (cfm)	Clg (cfm)	Design FR	Veloc (fpm)	Diam (in)	H x W (in)	Duct Material	Trunk
rt1	Peak AVF	1150	1150	0.101	863	14.5	8 x 24	ShtMetl	
rt3A	Peak AVF	271	287	0.101	645	8.6	8 x 8	ShtMetl	rt3
rt3B	Peak AVF	91	62	0.140	408	5.2	8 x 4	ShtMetl	rt3A
rt2A	Peak AVF	113	107	0.157	576	6.0	0 x 0	ShtMetl	rt2
rt2	Peak AVF	479	442	0.138	862	9.8	8 x 10	ShtMetl	rt1
rt3	Peak AVF	671	708	0.101	796	12.1	8 x 16	ShtMetl	rt1



Duct System Summary

Entire House

Doornbos Heating and Air Conditioning, Inc.

Job: Anderson Plan #2997
Date: February 11, 2012
By: R Doornbos
Plan: 2997

11310 South Cicero Avenue, Alsip, IL 60803 Phone: 708 423 9580 Fax: 708 423 7361 Email: ruhotorcold@gmail.com Web: www.doornbos.com

Project Information

For: Midwest Home, Illinois Institute of Technology
3201 South Dearborn, Chicago, IL 60616

TYPICAL TO WHAT WE FIND IN REAL HOMES

	Heating	Cooling
External static pressure	1.10 in H2O	1.10 in H2O
Pressure losses	0.35 in H2O	0.35 in H2O
Available static pressure	0.75 in H2O	0.75 in H2O
Supply / return available pressure	0.22 / 0.53 in H2O	0.22 / 0.53 in H2O
Lowest friction rate	0.168 in/100ft	0.168 in/100ft
Actual air flow	1150 cfm	1150 cfm
Total effective length (TEL)	447 ft	

Supply Branch Detail Table

Name	Design (Btuh)	Htg (cfm)	Clg (cfm)	Design FR	Diam (in)	H x W (in)	Duct Matl	Actual Ln (ft)	Ftg.Eqv Ln (ft)	Trunk
Bath	h 1465	36	16	0.214	4.0	0x0	ShMt	17.5	85.0	st1B
Bedroom 1	c 3095	104	114	0.179	6.0	0x0	ShMt	17.5	105.0	st1
Bedroom 2	h 4576	113	107	0.245	6.0	0x0	ShMt	29.5	60.0	st1
Bedroom 3	h 4382	108	106	0.237	6.0	0x0	ShMt	22.5	70.0	st1
Dining Room	h 5248	130	112	0.210	6.0	0x0	ShMt	34.5	70.0	st2
Family Room	c 2972	68	109	0.232	6.0	0x0	ShMt	34.5	60.0	st2
Family Room-A	c 2972	68	109	0.210	6.0	0x0	ShMt	24.5	80.0	st2
Foyer/Hallway	h 5423	134	91	0.216	6.0	0x0	ShMt	26.5	75.0	st2
Kitchen/Dinette	c 3067	90	112	0.187	6.0	0x0	ShMt	47.5	70.0	st2A
Kitchen/Dinette-A	c 3067	90	112	0.185	6.0	0x0	ShMt	38.5	80.0	st2A
Laundry	h 3672	91	62	0.168	6.0	0x0	ShMt	45.5	85.0	st2B
Master Bath	h 4769	118	100	0.253	6.0	0x0	ShMt	16.5	70.0	st1A

Supply Trunk Detail Table

Name	Trunk Type	Htg (cfm)	Clg (cfm)	Design FR	Veloc (fpm)	Diam (in)	H x W (in)	Duct Material	Trunk
st1B	Peak AVF	36	16	0.214	163	3.4	8 x 4	ShtMetl	st1A
st1A	Peak AVF	154	116	0.214	693	5.9	8 x 4	ShtMetl	st1
st1	Peak AVF	479	442	0.179	862	9.3	8 x 10	ShtMetl	
st2	Peak AVF	671	708	0.168	796	10.9	8 x 16	ShtMetl	
st2A	Peak AVF	271	287	0.168	645	7.8	8 x 8	ShtMetl	st2
st2B	Peak AVF	91	62	0.168	408	5.1	8 x 4	ShtMetl	st2A

Bold/italic values have been manually overridden

Return Branch Detail Table

Name	Grill Size (in)	Htg (cfm)	Clg (cfm)	TEL (ft)	Design FR	Veloc (fpm)	Diam (in)	H x W (in)	Stud/Joist Opening (in)	Duct Matl	Trunk
rb3	0x0	258	229	230.0	0.231	472	10.0	0x 0		ShMt	rt2
rb8	0x0	91	62	227.0	0.234	462	6.0	0x 0		ShMt	rt3B
rb1	0x0	180	225	316.0	0.168	644	8.0	0x 0		ShMt	rt3A
rb2	0x0	270	309	140.0	0.379	567	10.0	0x 0		ShMt	rt3
rb4	0x0	113	107	203.0	0.261	576	6.0	0x 0		ShMt	rt2A
rb5	0x0	108	106	147.0	0.361	552	6.0	0x 0		ShMt	rt2
rb6	0x0	130	112	171.0	0.310	661	6.0	0x 0		ShMt	rt3

Return Trunk Detail Table

Name	Trunk Type	Htg (cfm)	Clg (cfm)	Design FR	Veloc (fpm)	Diam (in)	H x W (in)	Duct Material	Trunk
rt1	Peak AVF	1150	1150	0.168	863	13.1	8 x 24	ShtMetl	
rt3A	Peak AVF	271	287	0.168	645	7.8	8 x 8	ShtMetl	rt3
rt3B	Peak AVF	91	62	0.234	408	4.7	8 x 4	ShtMetl	rt3A
rt2A	Peak AVF	113	107	0.261	830	5.0	0 x 0	ShtMetl	rt2
rt2	Peak AVF	479	442	0.231	862	8.8	8 x 10	ShtMetl	rt1
rt3	Peak AVF	671	708	0.168	796	10.9	8 x 16	ShtMetl	rt1



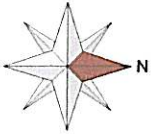

Level 1

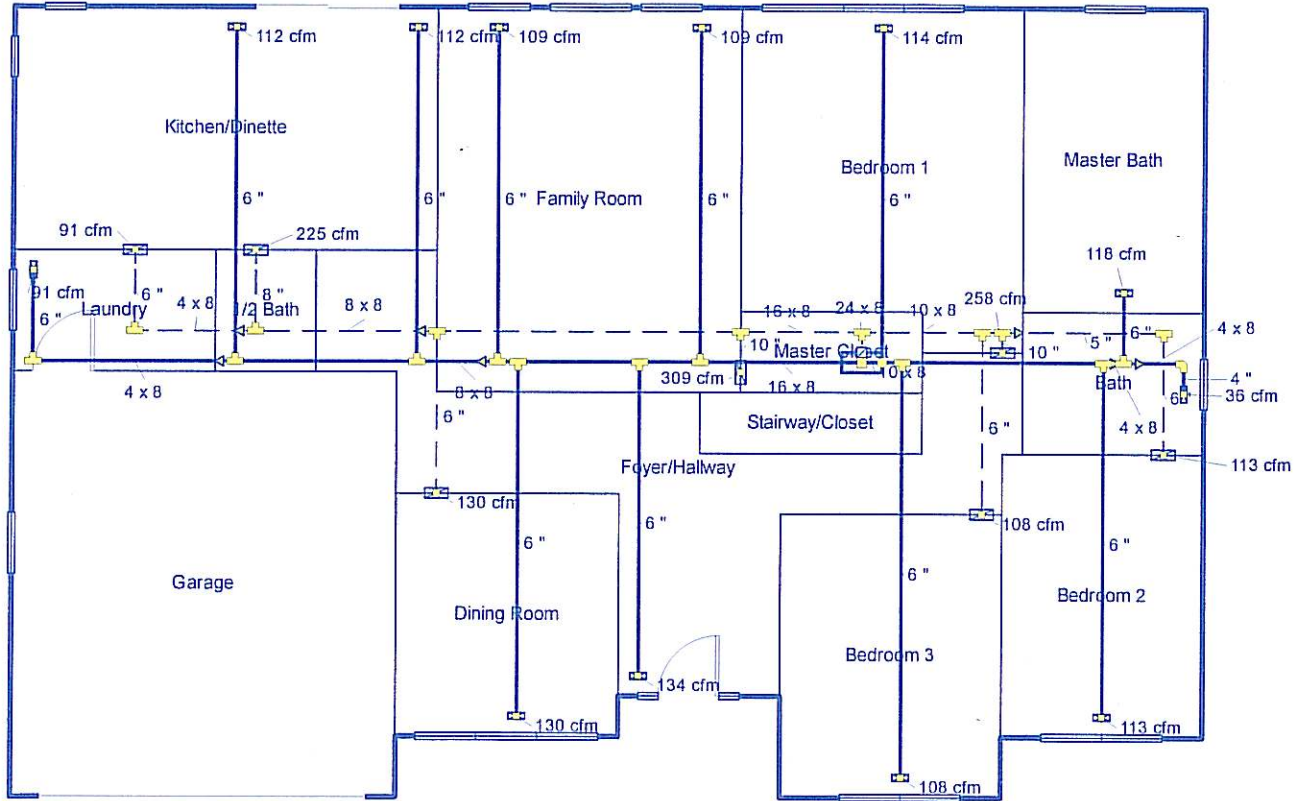

Job #: Anderson Plan #2997
Performed by R Doornbos for:
Midwest Home
3201 South Dearborn
Chicago, IL 60616

Doornbos Heating and Air Condit...
11310 South Cicero Avenue
Alsip, IL 60803
Phone: 708 423 9580 Fax: 708 423 7361
www.doornbos.com ruhotorcold@gmail.com

Scale: 1 : 114
Page 1
Right-Suite® Universal 2012
12.1.04 RSU17924
2013-Feb-12 09:51:09
...htsoft HVAC\Brent Stephens 1.rup

HEATING & AIR CONDITIONING by DOORNBOS

February 6, 2013

Dr. Brent Stephens
Illinois Institute of Technology
3201 So Dearborn (AM-212)
Chicago, Illinois 60616-3089

Re: AHRI Project
Southern Home

Scope of Work

- Carrier 25HBC560 outdoor heat pump
- Carrier FX4DN(BF)061 indoor fan/coil with electric heat
- Controls and low voltage control wiring
- Hart & Cooley ceiling mounted registers and grills
- Pre-cast concrete equipment slab and isolators, set on a granular base
- Full size secondary drain pan with overflow switch, isolators and dedicated secondary drain piping
- Primary drain piping from the fan/coil unit
- Refrigerant piping and insulation
- Ductwork distribution per the attached drawing including sealing and insulating
- Start-up and adjust
- Standard manufacturer's warranty
- One year warranty service
- All work shall be done in a neat, workmanlike manner, left clean and free of defects

Total installed price excluding permit fees:

Sheet Metal Duct @.2"	\$19,850.00
Sheet Metal Duct @.5"	\$19,350.00
Sheet Metal duct @.8"	\$18,950.00
Flex Duct @.2"	\$14,550.00
Flex Duct @.5"	\$13,800.00
Flex Duct @.8"	\$13,300.00

Four Generations of Good Business

www.doornbos.com

11310 S. Cicero Avenue • Alsip, Illinois 60803 • Phone (708) 423-9580 • Fax (708) 423-7361

Duct System Summary

Entire House

Doornbos Heating and Air Conditioning, Inc.

\$ 14,550.7

Job: .2" flex 11/3
Date: Feb4,2013
By: R Doornbos

11310 South Cicero Avenue, Alsip, IL 60803 Phone: 708 423 9580 Fax 708 423 7361 Email: ruhotorcold@gmail.com Web: www.doornbos.com

Project Information

For: AHRI Project Southern Home Flexible Duct System Illinois Institute of Technology
Austin, TX

	Heating	Cooling
External static pressure	0.20 in H2O	0.20 in H2O
Pressure losses	0 in H2O	0 in H2O
Available static pressure	0.20 in H2O	0.20 in H2O
Supply / return available pressure	0.11 / 0.09 in H2O	0.11 / 0.09 in H2O
Lowest friction rate	0.098 in/100ft	0.098 in/100ft
Actual air flow	1899 cfm	1899 cfm
Total effective length (TEL)		205 ft

Supply Branch Detail Table

Name	Design (Btuh)	Htg (cfm)	Clg (cfm)	Design FR	Diam (in)	H x W (in)	Duct Matl	Actual Ln (ft)	Ftg.Eqv Ln (ft)	Trunk
Bath 2	h 1338	49	44	0.113	6.0	0x0	VIFx	26.2	70.0	
Bed 2	h 2417	88	75	0.120	7.0	0x0	VIFx	21.1	70.0	
Bed 3	h 5086	185	107	0.108	10.0	0x0	VIFx	30.5	70.0	
Family	c 4312	116	176	0.108	10.0	0x0	VIFx	31.4	70.0	
Family-B	c 4312	116	176	0.107	10.0	0x0	VIFx	32.0	70.0	
Game/Teen	c 4039	155	165	0.114	8.0	0x0	VIFx	25.2	70.0	
Her WIC	h 2441	89	73	0.115	7.0	0x0	VIFx	25.2	70.0	
Kitchen/Breakfast	c 4950	177	202	0.116	10.0	0x0	VIFx	24.2	70.0	
Kitchen/Breakfast-A	c 4950	177	202	0.103	10.0	0x0	VIFx	36.4	70.0	
M Bath	h 2772	101	75	0.111	7.0	0x0	VIFx	28.7	70.0	
M Toilet	h 663	24	21	0.102	4.0	0x0	VIFx	36.4	70.0	
Master Bed	h 4526	165	146	0.103	8.0	0x0	VIFx	35.4	70.0	
Master Bed-A	h 4526	165	146	0.098	10.0	0x0	VIFx	41.8	70.0	
Study	h 5540	202	200	0.139	10.0	0x0	VIFx	8.2	70.0	
Utility	c 1535	21	63	0.121	6.0	0x0	VIFx	20.0	70.0	
WIC 3	h 1899	69	26	0.101	6.0	0x0	VIFx	37.5	70.0	

Bold/italic values have been manually overridden



12" flex

2/3

Return Branch Detail Table

Name	Grill Size (in)	Htg (cfm)	Clg (cfm)	TEL (ft)	Design FR	Veloc (fpm)	Diam (in)	H x W (in)	Stud/Joist Opening (in)	Duct Matl	Trunk
rb1	0x0	608	820	73.0	0.125	587	16.0	0x 0		VIFx	
rb2	0x0	137	120	75.5	0.120	392	8.0	0x 0		VIFx	
rb3	0x0	155	165	77.7	0.117	473	8.0	0x 0		VIFx	
rb4	0x0	543	461	88.3	0.103	508	14.0	0x 0		VIFx	
rb5	0x0	254	133	93.2	0.098	466	10.0	0x 0		VIFx	
rb8	0x0	202	200	65.7	0.139	370	10.0	0x 0		VIFx	



2/73

12" flex

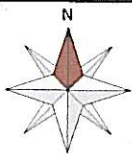

Level 1

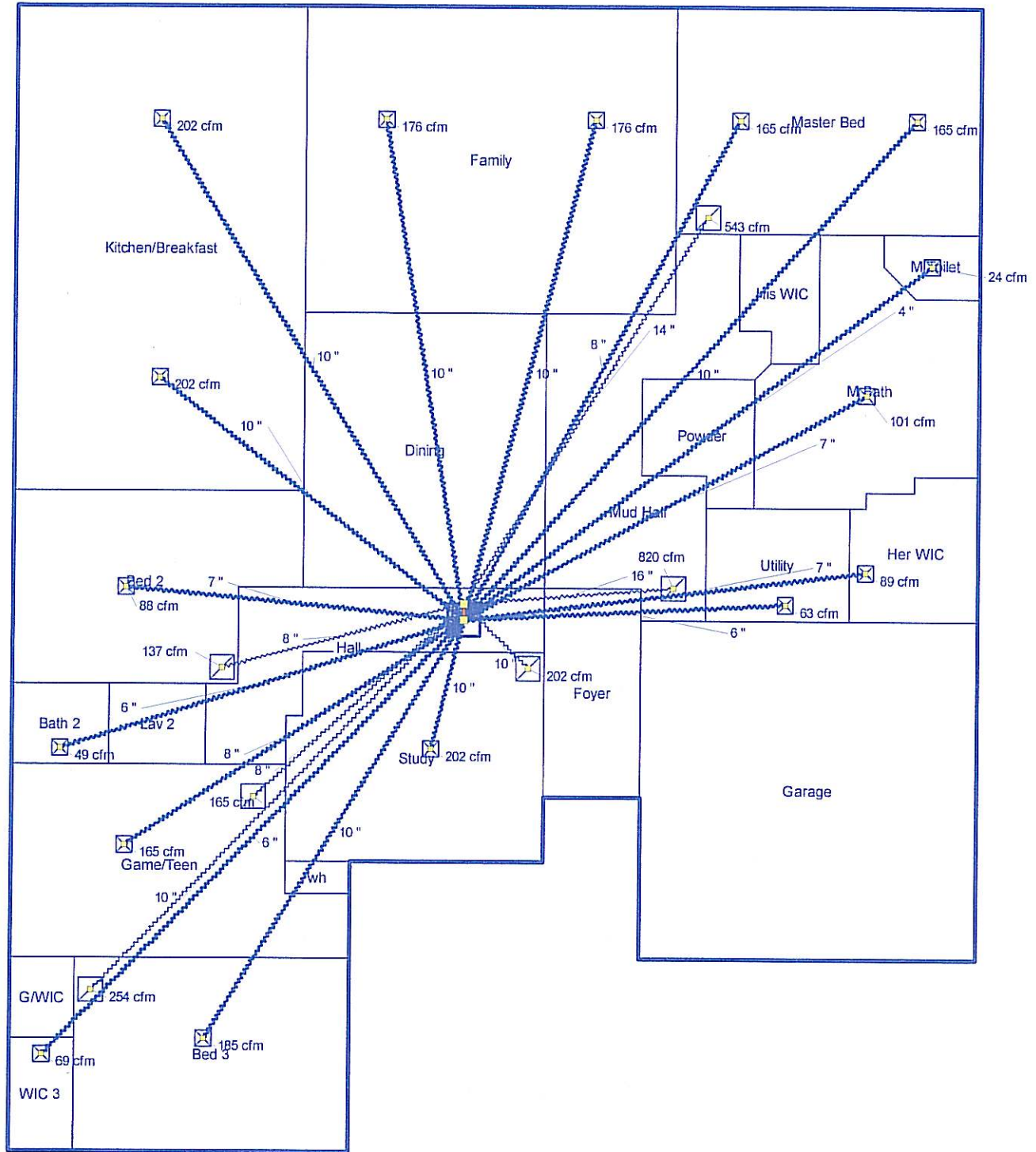

Job #:
Performed by R Doornbos for:
 AHRI Project Southern Home Flexible Duct System ...
 Austin, TX

Doornbos Heating and Air Conditio...
 11310 South Cicero Avenue
 Alsip, IL 60803
 Phone: 708 423 9580 Fax: 708 423 7361
 www.doornbos.com ruhotorcold@gmail.com

Scale: 1 : 113
 Page 1
 Right-Suite® Universal 2012
 12.1.04 RSU17924
 2013-Feb-04 16:59:02
 ...ject Southern Home Flex Duct.rup

Duct System Summary

Entire House

Doornbos Heating and Air Conditioning, Inc.

\$ 13,800

Job: 15" flex 1/3
Date: Feb4,2013
By: R Doornbos

11310 South Cicero Avenue, Alsip, IL 60803 Phone: 708 423 9580 Fax: 708 423 7361 Email: ruhotorcold@gmail.com Web: www.doornbos.com

Project Information

For: AHRI Project Southern Home Flexible Duct System Illinois Institute of Technology
Austin, TX

	Heating	Cooling
External static pressure	0.50 in H2O	0.50 in H2O
Pressure losses	0 in H2O	0 in H2O
Available static pressure	0.50 in H2O	0.50 in H2O
Supply / return available pressure	0.27 / 0.23 in H2O	0.27 / 0.23 in H2O
Lowest friction rate	0.244 in/100ft	0.244 in/100ft
Actual air flow	1899 cfm	1899 cfm
Total effective length (TEL)	205 ft	

Supply Branch Detail Table

Name	Design (Btuh)	Htg (cfm)	Clg (cfm)	Design FR	Diam (in)	H x W (in)	Duct Matl	Actual Ln (ft)	Ftg.Eqv Ln (ft)	Trunk
Bath 2	h 1338	49	44	0.283	6.0	0x0	VIFx	26.2	70.0	
Bed 2	h 2417	88	75	0.299	6.0	0x0	VIFx	21.1	70.0	
Bed 3	h 5086	185	107	0.271	7.0	0x0	VIFx	30.5	70.0	
Family	c 4312	116	176	0.269	7.0	0x0	VIFx	31.4	70.0	
Family-B	c 4312	116	176	0.267	7.0	0x0	VIFx	32.0	70.0	
Game/Teen	c 4039	155	165	0.286	7.0	0x0	VIFx	25.2	70.0	
Her WIC	h 2441	89	73	0.286	6.0	0x0	VIFx	25.2	70.0	
Kitchen/Breakfast	c 4950	177	202	0.289	8.0	0x0	VIFx	24.2	70.0	
Kitchen/Breakfast-A	c 4950	177	202	0.256	8.0	0x0	VIFx	36.4	70.0	
M Bath	h 2772	101	75	0.276	6.0	0x0	VIFx	28.7	70.0	
M Toilet	h 663	24	21	0.256	4.0	0x0	VIFx	36.4	70.0	
Master Bed	h 4526	165	146	0.259	7.0	0x0	VIFx	35.4	70.0	
Master Bed-A	h 4526	165	146	0.244	7.0	0x0	VIFx	41.8	70.0	
Study	h 5540	202	200	0.348	8.0	0x0	VIFx	8.2	70.0	
Utility	c 1535	21	63	0.303	6.0	0x0	VIFx	20.0	70.0	
WIC 3	h 1899	69	26	0.254	6.0	0x0	VIFx	37.5	70.0	

Bold/italic values have been manually overridden



.5" flex

2/3

Return Branch Detail Table

Name	Grill Size (in)	Htg (cfm)	Clg (cfm)	TEL (ft)	Design FR	Veloc (fpm)	Diam (in)	H x W (in)	Stud/Joist Opening (in)	Duct Matl	Trunk
rb8	0x0	202	200	64.5	0.353	578	8.0	0x 0		VIFx	
rb1	0x0	608	820	73.0	0.311	587	16.0	0x 0		VIFx	
rb2	0x0	137	120	75.5	0.301	512	7.0	0x 0		VIFx	
rb3	0x0	155	165	77.7	0.293	473	8.0	0x 0		VIFx	
rb4	0x0	543	461	88.3	0.258	508	14.0	0x 0		VIFx	
rb5	0x0	254	133	93.2	0.244	466	10.0	0x 0		VIFx	

.5" net
3/27

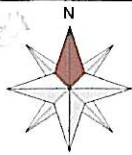

Level 1

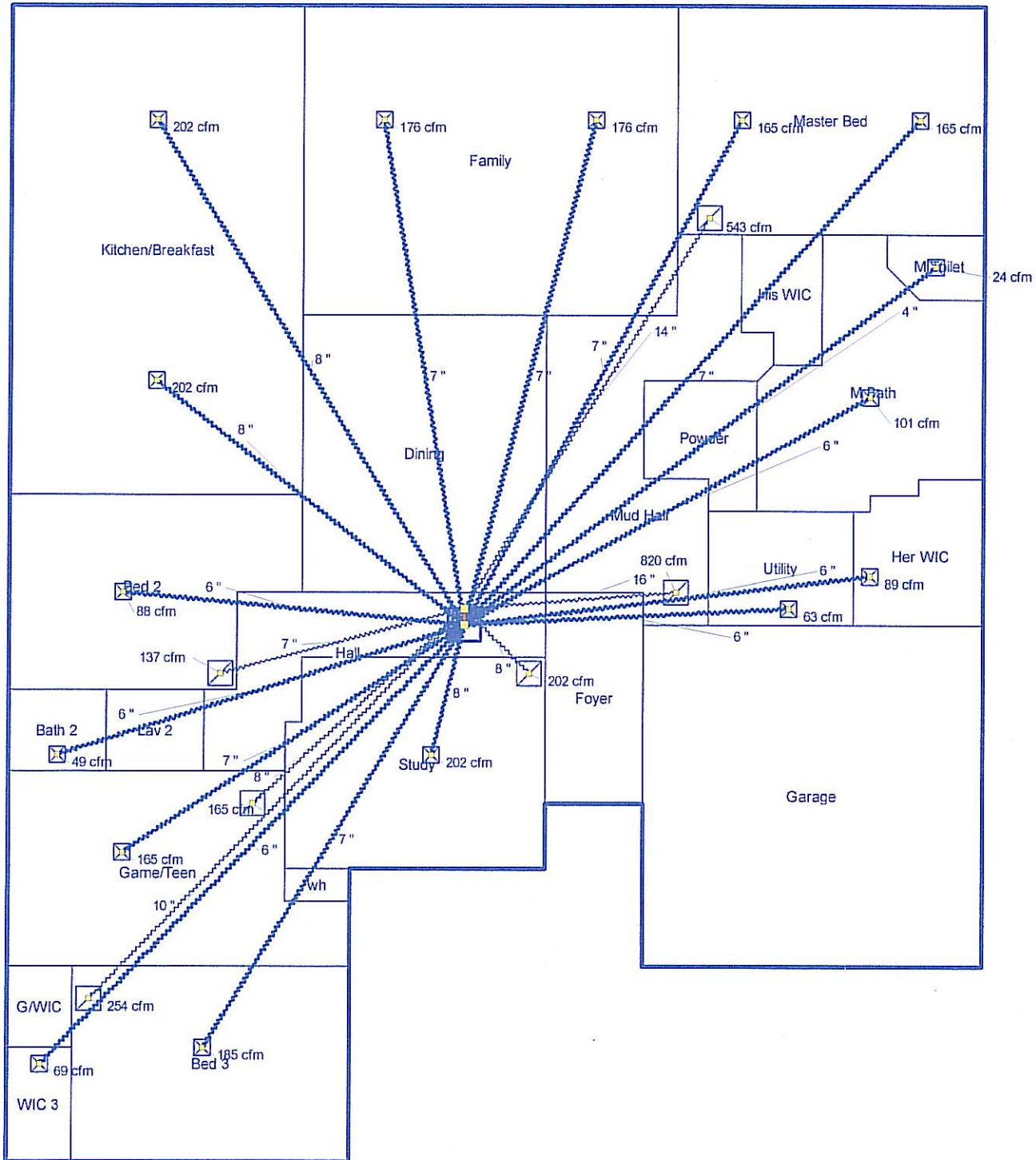

Job #:
Performed by R Doornbos for:
 AHRI Project Southern Home Flexible Duct System ...
 Austin, TX

Doornbos Heating and Air Conditiono...
 11310 South Cicero Avenue
 Alsip, IL 60803
 Phone: 708 423 9580 Fax: 708 423 7361
 www.doornbos.com ruhotorcold@gmail.com

Scale: 1 : 113
 Page 1
 Right-Suite® Universal 2012
 12.1.04 RSU17924
 2013-Feb-04 16:41:30
 ...ject Southern Home Flex Duct.rup

Duct System Summary
Entire House

Doornbos Heating and Air Conditioning, Inc.

\$13,300⁺

Job: *18 Flex*
Date: Feb4,2013
By: R Doornbos

1/3

11310 South Cicero Avenue, Alsip, IL 60803 Phone: 708 423 9580 Fax: 708 423 7361 Email: ruhotorcold@gmail.com Web: www.doornbos.com

Project Information

For: AHRI Project Southern Home Flexible Duct System, Illinois Institute of Technology
Austin, TX

	Heating	Cooling
External static pressure	0.80 in H2O	0.80 in H2O
Pressure losses	0 in H2O	0 in H2O
Available static pressure	0.80 in H2O	0.80 in H2O
Supply / return available pressure	0.44 / 0.36 in H2O	0.44 / 0.36 in H2O
Lowest friction rate	0.390 in/100ft	0.390 in/100ft
Actual air flow	1899 cfm	1899 cfm
Total effective length (TEL)	205 ft	

Supply Branch Detail Table

Name	Design (Btuh)	Htg (cfm)	Clg (cfm)	Design FR	Diam (in)	H x W (in)	Duct Matl	Actual Ln (ft)	Ftg.Eqv Ln (ft)	Trunk
Bath 2	h 1338	49	44	0.453	4.0	0x0	VIFx	26.2	70.0	
Bed 2	h 2417	88	75	0.479	6.0	0x0	VIFx	21.1	70.0	
Bed 3	h 5086	185	107	0.434	7.0	0x0	VIFx	30.5	70.0	
Family	c 4312	116	176	0.430	7.0	0x0	VIFx	31.4	70.0	
Family-B	c 4312	116	176	0.428	7.0	0x0	VIFx	32.0	70.0	
Game/Teen	c 4039	155	165	0.458	7.0	0x0	VIFx	25.2	70.0	
Her WIC	h 2441	89	73	0.458	6.0	0x0	VIFx	25.2	70.0	
Kitchen/Breakfast	c 4950	177	202	0.463	8.0	0x0	VIFx	24.2	70.0	
Kitchen/Breakfast-A	c 4950	177	202	0.410	8.0	0x0	VIFx	36.4	70.0	
M Bath	h 2772	101	75	0.442	6.0	0x0	VIFx	28.7	70.0	
M Toilet	h 663	24	21	0.410	4.0	0x0	VIFx	36.4	70.0	
Master Bed	h 4526	165	146	0.414	7.0	0x0	VIFx	35.4	70.0	
Master Bed-A	h 4526	165	146	0.390	7.0	0x0	VIFx	41.8	70.0	
Study	h 5540	202	200	0.557	8.0	0x0	VIFx	8.2	70.0	
Utility	c 1535	21	63	0.484	6.0	0x0	VIFx	20.0	70.0	
WIC 3	h 1899	69	26	0.406	6.0	0x0	VIFx	37.5	70.0	

Bold/italic values have been manually overridden

.8" flex

2/3

Return Branch Detail Table

Name	Grill Size (in)	Htg (cfm)	Clg (cfm)	TEL (ft)	Design FR	Veloc (fpm)	Diam (in)	H x W (in)	Stud/Joist Opening (in)	Duct Matl	Trunk
rb1	0x0	608	820	73.0	0.498	587	16.0	0x 0		VIFx	
rb2	0x0	137	120	75.5	0.482	512	7.0	0x 0		VIFx	
rb3	0x0	155	165	77.7	0.468	473	8.0	0x 0		VIFx	
rb4	0x0	543	461	88.3	0.412	508	14.0	0x 0		VIFx	
rb5	0x0	254	133	93.2	0.390	466	10.0	0x 0		VIFx	
rb8	0x0	202	200	65.7	0.554	578	8.0	0x 0		VIFx	



18" net 2/13

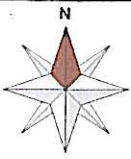

Level 1

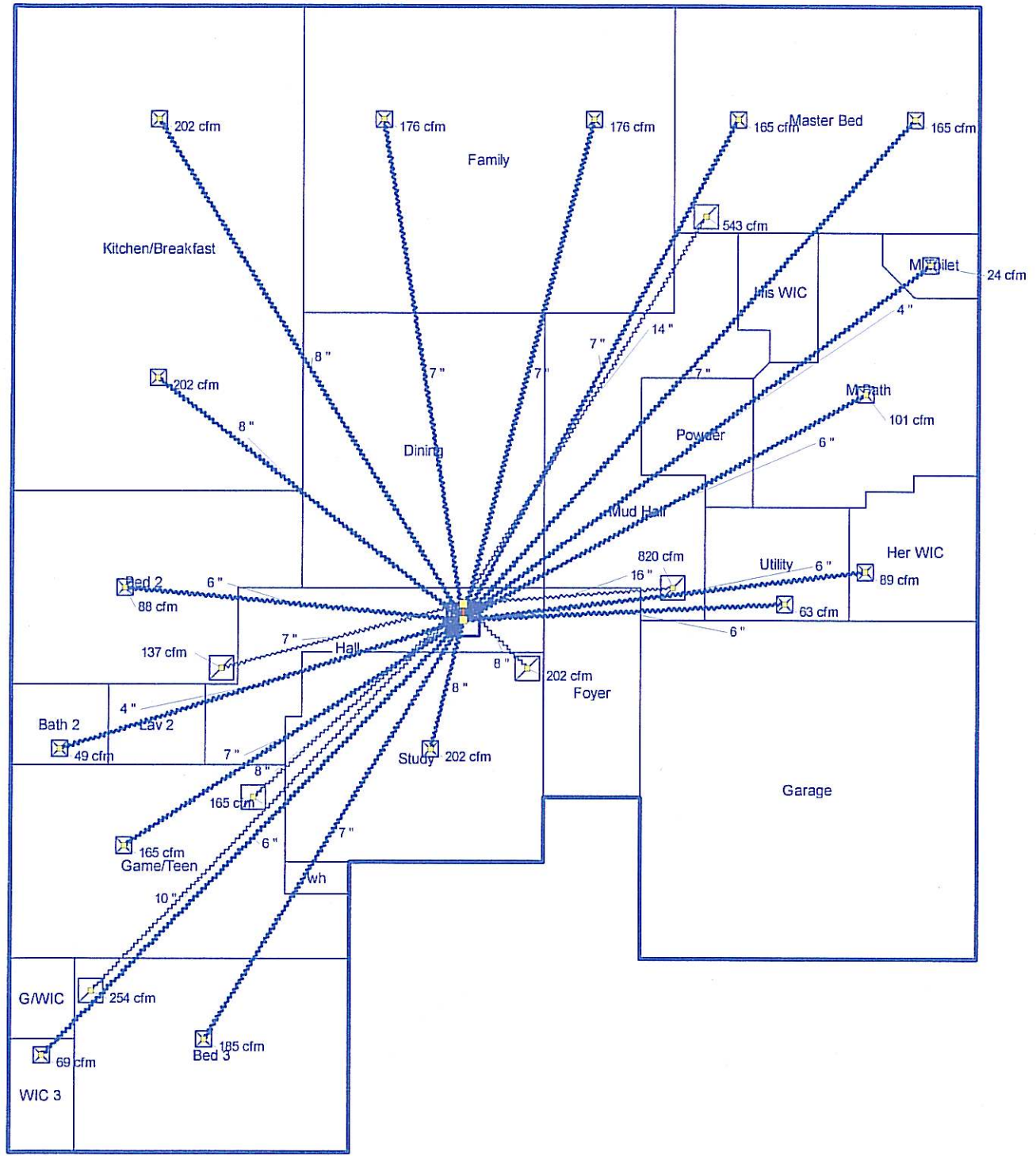

Job #:
Performed by R Doornbos for:
 AHRI Project Southern Home Flexible Duct System ...
 Austin, TX

Doornbos Heating and Air Conditio...
 11310 South Cicero Avenue
 Alsip, IL 60803
 Phone: 708 423 9580 Fax: 708 423 7361
 www.doornbos.com ruhotorcold@gmail.com

Scale: 1 : 113
 Page 1
 Right-Suite® Universal 2012
 12.1.04 RSU17924
 2013-Feb-04 17:06:39
 ...ject Southern Home Flex Duct.rup

Duct System Summary
Entire House

Doornbos Heating and Air Conditioning, Inc.

Job: 12 S/M 1/3
Date: Feb.1,2013
By: R Doornbos

11310 South Cicero Avenue, Alsip, IL 60803 Phone: 708 423 9580 Fax: 708 423 7361 Email: ruhotorcold@gmail.com Web: www.doornbos.com

Project Information

For: Southern Home AHRI Project, Illinois Institute of Technology
Austin, TX

	Heating	Cooling
External static pressure	0.20 in H2O	0.20 in H2O
Pressure losses	0 in H2O	0 in H2O
Available static pressure	0.20 in H2O	0.20 in H2O
Supply / return available pressure	0.13 / 0.07 in H2O	0.13 / 0.07 in H2O
Lowest friction rate	0.039 in/100ft	0.039 in/100ft
Actual air flow	1899 cfm	1899 cfm
Total effective length (TEL)	519 ft	

Supply Branch Detail Table

Name	Design (Btuh)	Htg (cfm)	Clg (cfm)	Design FR	Diam (in)	H x W (in)	Duct Matl	Actual Ln (ft)	Ftg.Eqv Ln (ft)	Trunk
Bath 2	h 1338	49	44	0.046	6.0	0x0	ShMt	28.0	250.0	st10
Bed 2	h 2417	88	75	0.082	6.0	0x0	ShMt	20.0	135.0	st11
Bed 3	h 5086	185	107	0.047	10.0	0x0	ShMt	41.0	230.0	st10
Breakfast-A	h 6696	244	237	0.045	10.0	0x0	ShMt	46.0	235.0	st7
Family	c 4312	116	176	0.043	10.0	0x0	ShMt	38.0	255.0	st7
Family-B	c 4312	116	176	0.044	10.0	0x0	ShMt	45.0	245.0	st6
Game/Teen-A	c 4039	155	165	0.047	10.0	0x0	ShMt	30.0	240.0	st10
Her WIC	h 2441	89	73	0.060	7.0	0x0	ShMt	38.0	175.0	st2B
Kitchen	c 4097	111	168	0.057	8.0	0x0	ShMt	28.0	195.0	st1
M Bath	h 2772	101	75	0.061	7.0	0x0	ShMt	44.0	165.0	st2A
M Toilet	h 663	24	21	0.039	4.0	0x0	ShMt	64.0	265.0	st6A
Master Bed	h 4526	165	146	0.041	10.0	0x0	ShMt	64.0	245.0	st6A
Master Bed-B	h 4526	165	146	0.044	10.0	0x0	ShMt	54.0	235.0	st6
Study	h 5540	202	200	0.085	8.0	0x0	ShMt	10.0	140.0	st2
Utility	c 1535	21	63	0.086	6.0	0x0	ShMt	28.0	120.0	st2
WIC 3	h 1899	69	26	0.044	6.0	0x0	ShMt	50.0	240.0	st10A

Bold/italic values have been manually overridden



2 S/M 7/3

Supply Trunk Detail Table

Name	Trunk Type	Htg (cfm)	Clg (cfm)	Design FR	Veloc (fpm)	Diam (in)	H x W (in)	Duct Material	Trunk
st10	Peak AVF	458	342	0.044	428	14.0	0 x 0	ShtMetl	st3
st10A	Peak AVF	69	26	0.044	352	6.0	0 x 0	ShtMetl	st10
st11	Peak AVF	88	75	0.082	448	6.0	0 x 0	ShtMetl	st3
st3	Peak AVF	546	418	0.044	511	14.0	0 x 0	ShtMetl	
st6A	Peak AVF	189	167	0.039	346	10.0	0 x 0	ShtMetl	st6
st1	Peak AVF	940	1070	0.039	606	18.0	0 x 0	ShtMetl	
st6	Peak AVF	470	489	0.039	457	14.0	0 x 0	ShtMetl	st1
st7	Peak AVF	360	414	0.043	527	12.0	0 x 0	ShtMetl	st1
st2	Peak AVF	413	411	0.060	525	12.0	0 x 0	ShtMetl	
st2B	Peak AVF	89	73	0.060	332	7.0	0 x 0	ShtMetl	st2A
st2A	Peak AVF	190	148	0.060	348	10.0	0 x 0	ShtMetl	st2

Return Branch Detail Table

Name	Grill Size (in)	Htg (cfm)	Clg (cfm)	TEL (ft)	Design FR	Veloc (fpm)	Diam (in)	H x W (in)	Stud/Joist Opening (in)	Duct Matl	Trunk
rb6	0x0	155	165	118.0	0.062	473	8.0	0x 0		ShMt	rt2
rb5	0x0	543	461	190.0	0.039	508	14.0	0x 0		ShMt	rt1
rb7	0x0	137	120	166.0	0.044	392	8.0	0x 0		ShMt	rt2
rb8	0x0	254	133	175.0	0.042	466	10.0	0x 0		ShMt	rt2A
rb9	0x0	202	200	99.0	0.074	578	8.0	0x 0		ShMt	rt2
rb4	0x0	608	820	58.0	0.126	587	16.0	0x 0		ShMt	rt1

Return Trunk Detail Table

Name	Trunk Type	Htg (cfm)	Clg (cfm)	Design FR	Veloc (fpm)	Diam (in)	H x W (in)	Duct Material	Trunk
rt2	Peak AVF	748	618	0.042	535	16.0	0 x 0	ShtMetl	
rt1	Peak AVF	1151	1281	0.039	587	20.0	0 x 0	ShtMetl	
rt2A	Peak AVF	254	133	0.042	466	10.0	0 x 0	ShtMetl	rt2

25/11

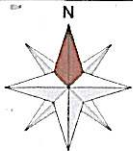

Level 1

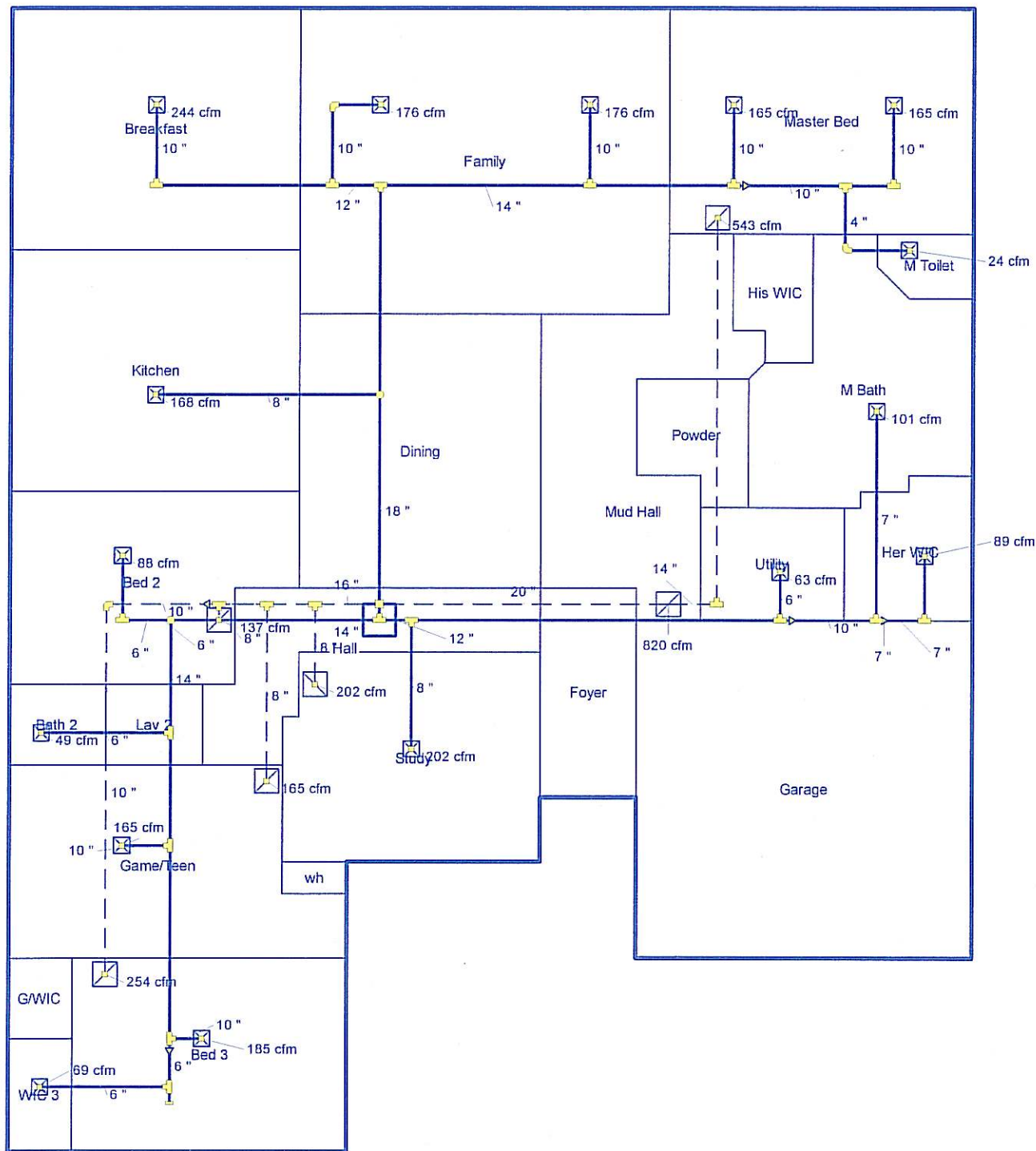

Job #:
Performed by R Doornbos for:
 Southern Home AHRI Project
 Austin, TX

Doornbos Heating and Air Conditi...
 11310 South Cicero Avenue
 Alsip, IL 60803
 Phone: 708 423 9580 Fax: 708 423 7361
 www.doornbos.com ruhotorcold@gmail.com

Scale: 1 : 115
 Page 1
 Right-Suite® Universal 2012
 12.1.04 RSU17924
 2013-Feb-04 20:13:05
 ...them Home Metal Ducts .5esp.rup

Duct System Summary
Entire House

Doornbos Heating and Air Conditioning, Inc.

Job: *15 S/m*
Date: Feb.1,2013
By: R Doornbos

P 16,55 *1/3*

11310 South Cicero Avenue, Alsip, IL 60803 Phone: 708 423 9580 Fax: 708 423 7361 Email: ruhotorcold@gmail.com Web: www.doornbos.com

Project Information

For: Southern Home AHRI Project, Illinois Institute of Technology
Austin, TX

	Heating	Cooling
External static pressure	0.50 in H2O	0.50 in H2O
Pressure losses	0 in H2O	0 in H2O
Available static pressure	0.50 in H2O	0.50 in H2O
Supply / return available pressure	0.32 / 0.18 in H2O	0.32 / 0.18 in H2O
Lowest friction rate	0.096 in/100ft	0.096 in/100ft
Actual air flow	1899 cfm	1899 cfm
Total effective length (TEL)		519 ft

Supply Branch Detail Table

Name	Design (Btuh)	Htg (cfm)	Clg (cfm)	Design FR	Diam (in)	H x W (in)	Duct Matl	Actual Ln (ft)	Ftg.Eqv Ln (ft)	Trunk
Bath 2	h 1338	49	44	0.114	6.0	0x0	ShMt	28.0	250.0	st10
Bed 2	h 2417	88	75	0.204	6.0	0x0	ShMt	20.0	135.0	st11
Bed 3	h 5086	185	107	0.117	8.0	0x0	ShMt	42.0	230.0	st10
Breakfast-A	h 6696	244	237	0.113	8.0	0x0	ShMt	46.0	235.0	st7
Family	c 4312	116	176	0.108	8.0	0x0	ShMt	38.0	255.0	st7
Family-B	c 4312	116	176	0.109	8.0	0x0	ShMt	45.0	245.0	st6
Game/Teen-A	c 4039	155	165	0.117	7.0	0x0	ShMt	30.0	240.0	st10
Her WIC	h 2441	89	73	0.149	6.0	0x0	ShMt	38.0	175.0	st2B
Kitchen	c 4097	111	168	0.142	7.0	0x0	ShMt	28.0	195.0	st1
M Bath	h 2772	101	75	0.152	6.0	0x0	ShMt	44.0	165.0	st2A
M Toilet	h 663	24	21	0.096	4.0	0x0	ShMt	64.0	265.0	st6A
Master Bed	h 4526	165	146	0.103	7.0	0x0	ShMt	64.0	245.0	st6A
Master Bed-B	h 4526	165	146	0.110	7.0	0x0	ShMt	54.0	235.0	st6
Study	h 5540	202	200	0.211	7.0	0x0	ShMt	10.0	140.0	st2
Utility	c 1535	21	63	0.214	6.0	0x0	ShMt	28.0	120.0	st2
WIC 3	h 1899	69	26	0.109	6.0	0x0	ShMt	50.0	240.0	st10A

Bold/Italic values have been manually overridden

1.5 S/m 2/3

Supply Trunk Detail Table

Name	Trunk Type	Htg (cfm)	Clg (cfm)	Design FR	Veloc (fpm)	Diam (in)	H x W (in)	Duct Material	Trunk
st10	Peak AVF	458	342	0.109	583	12.0	0 x 0	ShtMetl	st3
st10A	Peak AVF	69	26	0.109	352	6.0	0 x 0	ShtMetl	st10
st11	Peak AVF	88	75	0.204	448	6.0	0 x 0	ShtMetl	st3
st3	Peak AVF	546	418	0.109	695	12.0	0 x 0	ShtMetl	
st6A	Peak AVF	189	167	0.096	541	8.0	0 x 0	ShtMetl	st6
st1	Peak AVF	940	1070	0.096	766	16.0	0 x 0	ShtMetl	
st6	Peak AVF	470	489	0.096	623	12.0	0 x 0	ShtMetl	st1
st7	Peak AVF	360	414	0.108	758	10.0	0 x 0	ShtMetl	st1
st2	Peak AVF	413	411	0.149	757	10.0	0 x 0	ShtMetl	
st2B	Peak AVF	89	73	0.149	453	6.0	0 x 0	ShtMetl	st2A
st2A	Peak AVF	190	148	0.149	710	7.0	0 x 0	ShtMetl	st2

Return Branch Detail Table

Name	Grill Size (in)	Htg (cfm)	Clg (cfm)	TEL (ft)	Design FR	Veloc (fpm)	Diam (in)	H x W (in)	Stud/Joist Opening (in)	Duct Matl	Trunk
rb6	0x0	155	165	118.0	0.155	618	7.0	0x 0		ShMt	rt2
rb5	0x0	543	461	190.0	0.096	692	12.0	0x 0		ShMt	rt1
rb7	0x0	137	120	166.0	0.110	512	7.0	0x 0		ShMt	rt2
rb8	0x0	254	133	175.0	0.105	466	10.0	0x 0		ShMt	rt2A
rb9	0x0	202	200	99.0	0.185	578	8.0	0x 0		ShMt	rt2
rb4	0x0	608	820	58.0	0.316	587	16.0	0x 0		ShMt	rt1

Return Trunk Detail Table

Name	Trunk Type	Htg (cfm)	Clg (cfm)	Design FR	Veloc (fpm)	Diam (in)	H x W (in)	Duct Material	Trunk
rt2	Peak AVF	748	618	0.105	699	14.0	0 x 0	ShtMetl	
rt1	Peak AVF	1151	1281	0.096	587	20.0	0 x 0	ShtMetl	
rt2A	Peak AVF	254	133	0.105	466	10.0	0 x 0	ShtMetl	rt2

15 s/m 3/3



Level 1

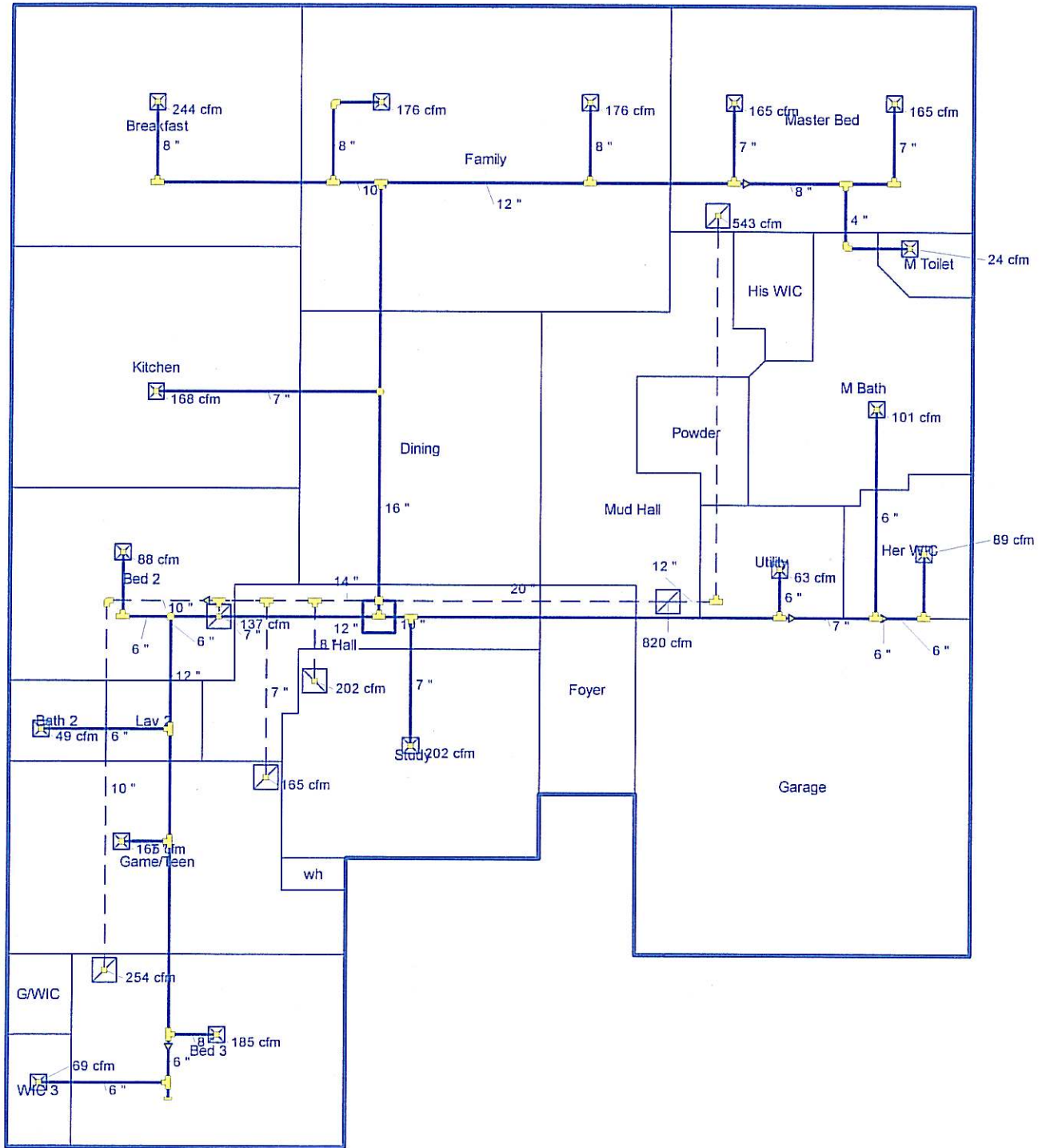

Job #:
Performed by R Doornbos for:
 Southern Home AHRI Project
 Austin, TX

Doornbos Heating and Air Conditio...
 11310 South Cicero Avenue
 Alsip, IL 60803
 Phone: 708 423 9580 Fax: 708 423 7361
 www.doornbos.com ruhotorcold@gmail.com

Scale: 1 : 115
 Page 1
 Right-Suite® Universal 2012
 12.1.04 RSU17924
 2013-Feb-04 20:06:09
 ...them Home Metal Ducts .5esp.rup

Duct System Summary

Entire House

Doornbos Heating and Air Conditioning, Inc.

\$ 16,950.

Job: , 8 s/m 1/3
Date: Feb.1,2013
By: R Doornbos

11310 South Cicero Avenue, Alsip, IL 60803 Phone: 708 423 9580 Fax: 708 423 7361 Email: ruhotorcold@gmail.com Web: www.doornbos.com

Project Information

For: Southern Home AHRI Project, Illinois Institute of Technology
Austin, TX

	Heating	Cooling
External static pressure	0.80 in H2O	0.80 in H2O
Pressure losses	0 in H2O	0 in H2O
Available static pressure	0.80 in H2O	0.80 in H2O
Supply / return available pressure	0.50 / 0.30 in H2O	0.50 / 0.30 in H2O
Lowest friction rate	0.157 in/100ft	0.157 in/100ft
Actual air flow	1899 cfm	1899 cfm
Total effective length (TEL)	509 ft	

Supply Branch Detail Table

Name	Design (Btuh)	Htg (cfm)	Clg (cfm)	Design FR	Diam (in)	H x W (in)	Duct Matl	Actual Ln (ft)	Ftg.Eqv Ln (ft)	Trunk
Bath 2	h 1338	49	44	0.174	4.0	0x0	ShMt	28.0	260.0	st10
Bed 2	h 2417	88	75	0.323	6.0	0x0	ShMt	20.0	135.0	st11
Bed 3	h 5086	185	107	0.178	7.0	0x0	ShMt	42.0	240.0	st10
Breakfast-A	h 6696	244	237	0.178	8.0	0x0	ShMt	46.0	235.0	st7
Family	c 4312	116	176	0.171	7.0	0x0	ShMt	38.0	255.0	st7
Family-B	c 4312	116	176	0.162	7.0	0x0	ShMt	45.0	265.0	st6
Game/Teen-A	c 4039	155	165	0.179	7.0	0x0	ShMt	30.0	250.0	st10
Her WIC	h 2441	89	73	0.260	6.0	0x0	ShMt	38.0	155.0	st2
Kitchen	c 4097	111	168	0.225	6.0	0x0	ShMt	28.0	195.0	st1
M Bath	h 2772	101	75	0.240	6.0	0x0	ShMt	44.0	165.0	st2
M Toilet	h 663	24	21	0.157	4.0	0x0	ShMt	64.0	255.0	st6
Master Bed	h 4526	165	146	0.168	7.0	0x0	ShMt	64.0	235.0	st6
Master Bed-B	h 4526	165	146	0.162	7.0	0x0	ShMt	54.0	255.0	st6
Study	h 5540	202	200	0.295	7.0	0x0	ShMt	10.0	160.0	st2
Utility	c 1535	21	63	0.339	4.0	0x0	ShMt	28.0	120.0	st2
WIC 3	h 1899	69	26	0.179	6.0	0x0	ShMt	50.0	230.0	st10

Bold/italic values have been manually overridden

.8 s/m 2/3

Supply Trunk Detail Table

Name	Trunk Type	Htg (cfm)	Clg (cfm)	Design FR	Veloc (fpm)	Diam (in)	H x W (in)	Duct Material	Trunk
st10	Peak AVF	458	342	0.174	840	10.0	0 x 0	ShtMetl	st3
st11	Peak AVF	88	75	0.323	448	6.0	0 x 0	ShtMetl	st3
st3	Peak AVF	546	418	0.174	695	12.0	0 x 0	ShtMetl	
st6	Peak AVF	470	489	0.157	897	10.0	0 x 0	ShtMetl	st1
st1	Peak AVF	940	1070	0.157	766	16.0	0 x 0	ShtMetl	
st7	Peak AVF	360	414	0.171	758	10.0	0 x 0	ShtMetl	st1
st2	Peak AVF	413	411	0.240	757	10.0	0 x 0	ShtMetl	

Return Branch Detail Table

Name	Grill Size (in)	Htg (cfm)	Clg (cfm)	TEL (ft)	Design FR	Veloc (fpm)	Diam (in)	H x W (in)	Stud/Joist Opening (in)	Duct Matl	Trunk
rb6	0x0	155	165	118.0	0.253	618	7.0	0x 0		ShMt	rt2
rb5	0x0	543	461	190.0	0.157	692	12.0	0x 0		ShMt	rt1
rb7	0x0	137	120	166.0	0.180	696	6.0	0x 0		ShMt	rt2
rb8	0x0	254	133	165.0	0.181	466	10.0	0x 0		ShMt	rt2
rb9	0x0	202	200	99.0	0.302	578	8.0	0x 0		ShMt	rt2
rb4	0x0	608	820	58.0	0.515	587	16.0	0x 0		ShMt	rt1

Return Trunk Detail Table

Name	Trunk Type	Htg (cfm)	Clg (cfm)	Design FR	Veloc (fpm)	Diam (in)	H x W (in)	Duct Material	Trunk
rt2	Peak AVF	748	618	0.180	699	14.0	0 x 0	ShtMetl	
rt1	Peak AVF	1151	1281	0.157	587	20.0	0 x 0	ShtMetl	



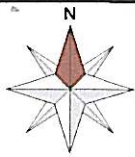

2/13
mfb

Level 1

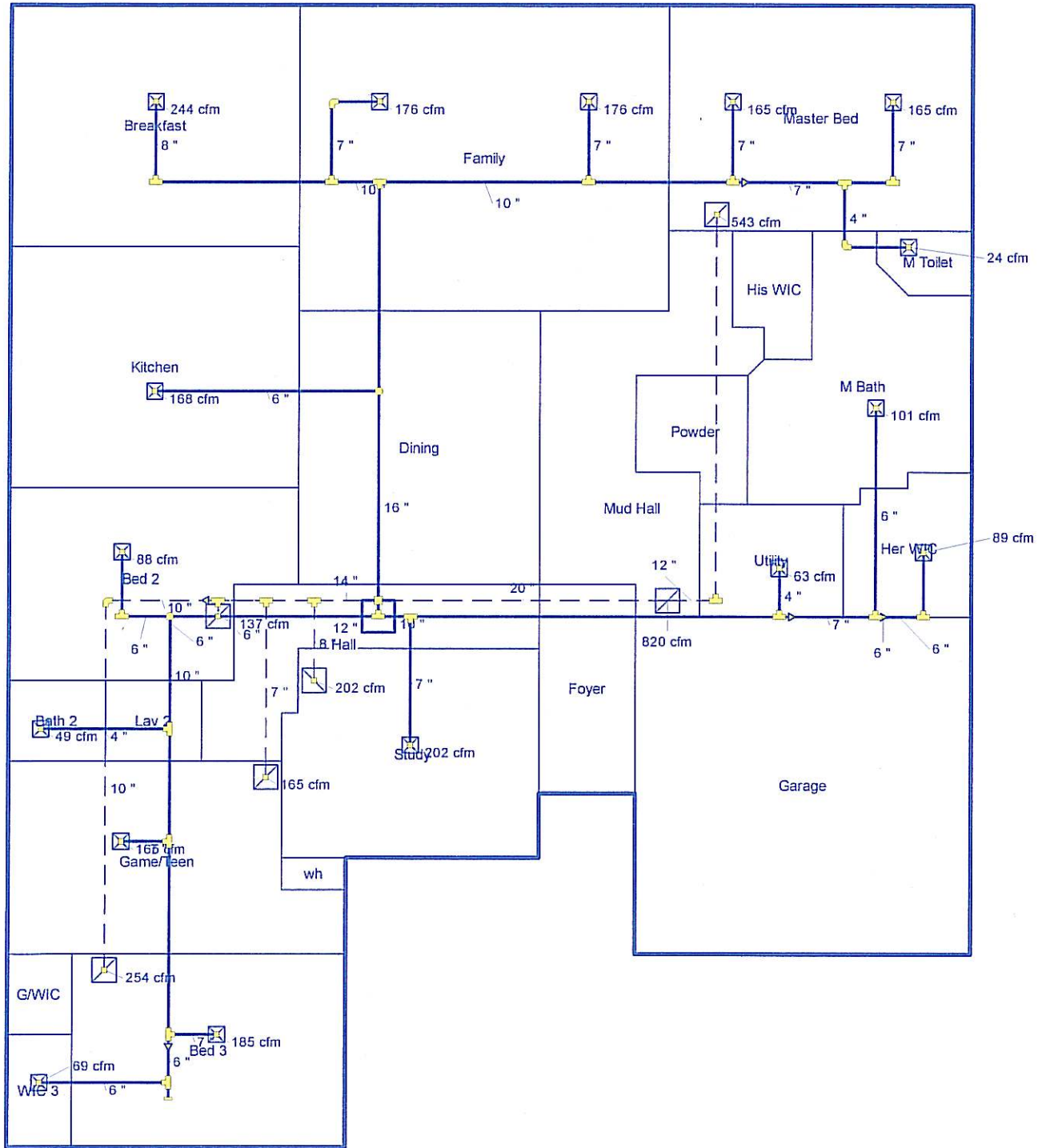

Job #:
Performed by R Doornbos for:
 Southern Home AHRI Project
 Austin, TX

Doornbos Heating and Air Conditio...
 11310 South Cicero Avenue
 Alsip, IL 60803
 Phone: 708 423 9580 Fax: 708 423 7361
 www.doornbos.com ruhotorcold@gmail.com

Scale: 1 : 115
 Page 1
 Right-Suite@ Universal 2012
 12.1.04 RSU17924
 2013-Feb-04 19:57:26
 ...them Home Metal Ducts .5esp.rup



13620 Immanuel Rd. • Pflugerville, Texas 78660 • (512)252-7711 • Fax (512) 252-7744

TACLB23145E

Illinois Institute of Technology

October 18, 2013

AHRI Project No. 8002

House #1

.15 Available / .50 External Static Pressures

Design Conditions:

R21 walls / R38 vented attic, R30 exposed floor over basement, .55 U-Value .35 SHGC Low E glass windows, window coverings where applicable, and front door facing East

Design Temperatures: Chicago, Midway AP - Summer ODB 92 / IDB 75 degrees, Winter ODB 4 / IDB 70 degrees

Price Includes:

One Lennox 14 SEER 3.0 Ton air conditioner with Lennox up-flow coil and 93% AFUE natural gas furnace, (1) Honeywell Focus Pro 6000 programmable thermostats, **R8 Fiberglass & R8 insulated flex duct** in crawlspace, Airmate stamped metal registers, disposable 1” MERV8 filters, running of copper, drain, and low-voltage control wire, system start-up & our standard one-year limited warranty.

HOUSE #1	FLEX DUCT	METAL DUCT
Equipment, Copper, Drains & Wiring	\$ 2,144.96	\$ 2,144.96
Supply Air Materials	\$ 937.56	\$ 1,744.74
Return Air Materials	\$ 208.44	\$ 733.22
In-House & Contractor Labor	\$ 870.00	\$ 1,908.00
Tax, Overhead & Profit	\$ 1,768.03	\$ 2,983.71
Estimated Total Installation Cost	\$ 5,929	\$ 9,515

Notes:

- 1) These quoted prices do not reflect installation of jumper duct returns, range, dryer or exhaust fan venting typically included in our estimates.
- 2) Supply & Return Air Materials also includes miscellaneous items such as mastic, foil tape, boots, grilles, filters, duct insulation wrap, straps and screws.

Exclusions:

Electrical, plumbing, carpentry, connecting drain lines, building catwalks and platforms, jumper ducts, range venting, dryer venting, exhaust fans or venting, IAO products, permitting, hanging the stove hood, make-up air if required, third-party testing or inspection fees, third-party rating program requirements, or sealing supply and return registers to the sheetrock.

Warranty:

Price includes standard limited warranty of one year on the entire installation, with an additional nine years on parts **when registered at www.lennoxregistration.com by homeowner** or four years when not registered. This does not include routine maintenance performed by the property owner or any other limitation as noted on the equipment manufacturer’s limited warranty certificate.



13620 Immanuel Rd. • Pflugerville, Texas 78660 • (512)252-7711 • Fax (512) 252-7744

TACLB23145E

Illinois Institute of Technology
AHRI Project No. 8002

October 18, 2013

House #1

.45 Available / .80 External Static Pressures

Design Conditions:

R21 walls / R38 vented attic, R30 exposed floor over basement, .55 U-Value .35 SHGC Low E glass windows, window coverings where applicable, and front door facing East

Design Temperatures: Chicago, Midway AP - Summer ODB 92 / IDB 75 degrees, Winter ODB 4 / IDB 70 degrees

Price Includes:

One Lennox 14 SEER 3.0 Ton air conditioner with Lennox up-flow coil and 93% AFUE natural gas furnace, (1) Honeywell Focus Pro 6000 programmable thermostats, **R8 Fiberglass & R8 insulated flex duct OR R8 wrapped metal ducts** in crawlspace, Airmate stamped metal registers, disposable 1” MERV8 filters, running of copper, drain, and low-voltage control wire, system start-up & our standard one-year limited warranty.

HOUSE #1	FLEX DUCT	METAL DUCT
Equipment, Copper, Drains & Wiring	\$ 2,144.96	\$ 2,144.96
Supply Air Materials	\$ 855.27	\$ 1,726.60
Return Air Materials	\$ 208.44	\$ 787.30
In-House & Contractor Labor	\$ 870.00	\$ 1,908.00
Tax, Overhead & Profit	\$ 1,731.13	\$ 3,001.60
Estimated Total Installation Cost	\$ 5,810	\$ 9,568

Notes:

- 1) These quoted prices do not reflect installation of jumper duct returns, range, dryer or exhaust fan venting typically included in our estimates.
- 2) Supply & Return Air Materials also includes miscellaneous items such as mastic, foil tape, boots, grilles, filters, duct insulation wrap, straps and screws.

Exclusions:

Electrical, plumbing, carpentry, connecting drain lines, building catwalks and platforms, jumper ducts, range venting, dryer venting, exhaust fans or venting, IAO products, permitting, hanging the stove hood, make-up air if required, third-party testing or inspection fees, third-party rating program requirements, or sealing supply and return registers to the sheetrock.

Warranty:

Price includes standard limited warranty of one year on the entire installation, with an additional nine years on parts **when registered at www.lennoxregistration.com by homeowner** or four years when not registered. This does not include routine maintenance performed by the property owner or any other limitation as noted on the equipment manufacturer’s limited warranty certificate.



13620 Immanuel Rd. • Pflugerville, Texas 78660 • (512)252-7711 • Fax (512) 252-7744

TACLB23145E

Illinois Institute of Technology
AHRI Project No. 8002

October 18, 2013

House #1

.75 Available / 1.10 External Static Pressures

Design Conditions:

R21 walls / R38 vented attic, R30 exposed floor over basement, .55 U-Value .35 SHGC Low E glass windows, window coverings where applicable, and front door facing East

Design Temperatures: Chicago, Midway AP - Summer ODB 92 / IDB 75 degrees, Winter ODB 4 / IDB 70 degrees

Price Includes:

One Lennox 14 SEER 3.0 Ton air conditioner with Lennox up-flow coil and 93% AFUE natural gas furnace, (1) Honeywell Focus Pro 6000 programmable thermostats, **R8 Fiberglass & R8 insulated flex duct** in crawlspace, Airmate stamped metal registers, disposable 1” MERV8 filters, running of copper, drain, and low-voltage control wire, system start-up & our standard one-year limited warranty.

HOUSE #1	FLEX DUCT	METAL DUCT
Equipment, Copper, Drains & Wiring	\$ 2,144.96	\$ 2,144.96
Supply Air Materials	\$ 999.05	\$ 1,684.83
Return Air Materials	\$ 208.44	\$ 787.30
In-House & Contractor Labor	\$ 893.00	\$ 1,908.00
Tax, Overhead & Profit	\$ 1,802.21	\$ 2,980.81
Estimated Total Installation Cost	\$ 6,048	\$9,506

Notes:

- 1) These quoted prices do not reflect installation of jumper duct returns, range, dryer or exhaust fan venting typically included in our estimates.
- 2) Supply & Return Air Materials also includes miscellaneous items such as mastic, foil tape, boots, grilles, filters, duct insulation wrap, straps and screws.

Exclusions:

Electrical, plumbing, carpentry, connecting drain lines, building catwalks and platforms, jumper ducts, range venting, dryer venting, exhaust fans or venting, IAO products, permitting, hanging the stove hood, make-up air if required, third-party testing or inspection fees, third-party rating program requirements, or sealing supply and return registers to the sheetrock.

Warranty:

Price includes standard limited warranty of one year on the entire installation, with an additional nine years on parts **when registered at www.lennoxregistration.com by homeowner** or four years when not registered. This does not include routine maintenance performed by the property owner or any other limitation as noted on the equipment manufacturer’s limited warranty certificate.



Project Summary
Entire House
 Austin Air Conditioning, Inc.

Job:
 Date: 7/31/13
 By: ME

13620 Immanuel Rd., Pflugerville, TX 78660 Phone: 512-252-7711 Fax: 512-252-7744 Email: info@austinairconditioning.com Web: www.austinaircond.com License: TACL2314...

Project Information

For: AHRI Project No. 8002, The Impact of Duct Design on the Life Cycle of Residential HVAC Systems, Home #1, Flex Duct

Notes: R-21 WALLS, R-38 ATTIC, R-30 FLOOR OVER BASEMENT, .55 U-VALUE, .35 SHGC WINDOWS, FRONT DOOR FACES EAST

Design Information

Weather: Chicago Midway AP, IL, US

Winter Design Conditions

Outside db 4 °F
 Inside db 70 °F
 Design TD 66 °F

Summer Design Conditions

Outside db 92 °F
 Inside db 75 °F
 Design TD 17 °F
 Daily range L
 Relative humidity 50 %
 Moisture difference 40 gr/lb

Heating Summary

Structure 31001 Btuh
 Ducts 1425 Btuh
 Central vent (0 cfm) 0 Btuh
 Humidification 0 Btuh
 Piping 0 Btuh
 Equipment load 32426 Btuh

Sensible Cooling Equipment Load Sizing

Structure 18715 Btuh
 Ducts 503 Btuh
 Central vent (0 cfm) 0 Btuh
 Blower 0 Btuh
 Use manufacturer's data y
 Rate/swing multiplier 1.00
 Equipment sensible load 19218 Btuh

Infiltration

Method Simplified
 Construction quality Average
 Fireplaces 0

	Heating	Cooling
Area (ft ²)	1918	1918
Volume (ft ³)	18101	18101
Air changes/hour	0.38	0.20
Equiv. AVF (cfm)	115	60

Latent Cooling Equipment Load Sizing

Structure 2797 Btuh
 Ducts 647 Btuh
 Central vent (0 cfm) 0 Btuh
 Equipment latent load 3443 Btuh
 Equipment total load 22661 Btuh
 Req. total capacity at 0.78 SHR 2.1 ton

Heating Equipment Summary

Make Generic
 Trade
 Model 96% AFUE FURNACE
 AHRI ref

Efficiency	96 AFUE
Heating input	42790 MBtuh
Heating output	68000 Btuh
Temperature rise	53 °F
Actual air flow	1200 cfm
Air flow factor	0.037 cfm/Btuh
Static pressure	0.50 in H2O
Space thermostat	

Cooling Equipment Summary

Make GENERIC
 Trade
 Cond 3.0 TON AC
 Coil
 AHRI ref
 Efficiency 12.5 EER, 16 SEER

Sensible cooling	28000 Btuh
Latent cooling	8000 Btuh
Total cooling	36000 Btuh
Actual air flow	1200 cfm
Air flow factor	0.062 cfm/Btuh
Static pressure	0.50 in H2O
Load sensible heat ratio	0.85

Calculations approved by ACCA to meet all requirements of Manual J 8th Ed.





Duct System Summary

Entire House

Austin Air Conditioning, Inc.

Job:
Date: 7/31/13
By: ME

13620 Immanuel Rd, Pflugerville, TX 78660 Phone: 512-252-7711 Fax: 512-252-7744 Email: info@austinairconditioning.com Web: www.austinaircond.com License: TACLB2314...

Project Information

For: AHRI Project No. 8002, The Impact of Duct Design
on the Life Cycle of Residential HVAC Systems, Home #1, Flex Duct

	Heating	Cooling
External static pressure	0.50 in H2O	0.50 in H2O
Pressure losses	0.35 in H2O	0.35 in H2O
Available static pressure	0.15 in H2O	0.15 in H2O
Supply / return available pressure	0.12 / 0.03 in H2O	0.12 / 0.03 in H2O
Lowest friction rate	0.075 in/100ft	0.075 in/100ft
Actual air flow	1200 cfm	1200 cfm
Total effective length (TEL)		199 ft

Supply Branch Detail Table

Name	Design (Btuh)	Htg (cfm)	Clg (cfm)	Design FR	Diam (in)	H x W (in)	Duct Matl	Actual Ln (ft)	Ftg.Eqv Ln (ft)	Trunk
Bath	h 1108	41	19	0.081	4.0	0x0	VIFx	27.1	124.0	st11
Bed 1	c 2081	102	130	0.093	8.0	0x0	VIFx	23.0	109.0	st7
Bed 2	h 3253	120	85	0.082	7.0	0x0	VIFx	25.6	124.0	st11
Bed 3	h 3114	115	85	0.086	8.0	0x0	VIFx	33.6	109.0	st10
Dinette	c 2189	112	137	0.086	8.0	0x0	VIFx	38.5	104.0	st8
Dining	h 3613	134	116	0.088	8.0	0x0	VIFx	30.6	109.0	st12
Family	c 1828	89	114	0.086	8.0	0x0	VIFx	38.5	104.0	st6
Family-A	c 1828	89	114	0.094	8.0	0x0	VIFx	26.5	104.0	st6
Foyer	c 1812	101	113	0.097	8.0	0x0	VIFx	17.8	109.0	st12
Kitchen	c 1838	94	115	0.078	8.0	0x0	VIFx	48.6	109.0	st8
Laundry	c 1131	67	71	0.075	5.0	0x0	VIFx	53.6	109.0	st9
M Bath	h 3275	121	94	0.090	8.0	0x0	VIFx	27.5	109.0	st7
Pwd	h 398	15	7	0.079	4.0	0x0	VIFx	45.3	109.0	st9

Bold/italic values have been manually overridden

Supply Trunk Detail Table

Name	Trunk Type	Htg (cfm)	Clg (cfm)	Design FR	Veloc (fpm)	Diam (in)	H x W (in)	Duct Material	Trunk
st7	Peak AVF	223	224	0.090	411	10.0	0 x 0	VinlFix	st1
st3	Peak AVF	82	77	0.075	416	6.0	0 x 0	VinlFix	
st1	Peak AVF	223	224	0.090	411	10.0	0 x 0	VinlFix	
st2	Peak AVF	206	251	0.078	461	10.0	0 x 0	VinlFix	
st4	Peak AVF	277	189	0.081	507	10.0	0 x 0	VinlFix	
st5	Peak AVF	235	229	0.088	430	10.0	0 x 0	VinlFix	
st6	Peak AVF	179	228	0.086	419	10.0	0 x 0	VinlFix	
st10	Peak AVF	277	189	0.081	507	10.0	0 x 0	VinlFix	
st12	Peak AVF	235	229	0.088	430	10.0	0 x 0	VinlFix	
st11	Peak AVF	161	105	0.081	462	8.0	0 x 0	VinlFix	
st8	Peak AVF	206	251	0.078	461	10.0	0 x 0	VinlFix	st4
st9	Peak AVF	82	77	0.075	416	6.0	0 x 0	VinlFix	st5
									st10
									st2
									st3

Return Branch Detail Table

Name	Grill Size (in)	Htg (cfm)	Clg (cfm)	TEL (ft)	Design FR	Veloc (fpm)	Diam (in)	H x W (in)	Stud/Joist Opening (in)	Duct Matl	Trunk
rb1	0x0	1200	1200	36.6	0.075	679	18.0	0x 0		VIFx	



1ST FLOOR

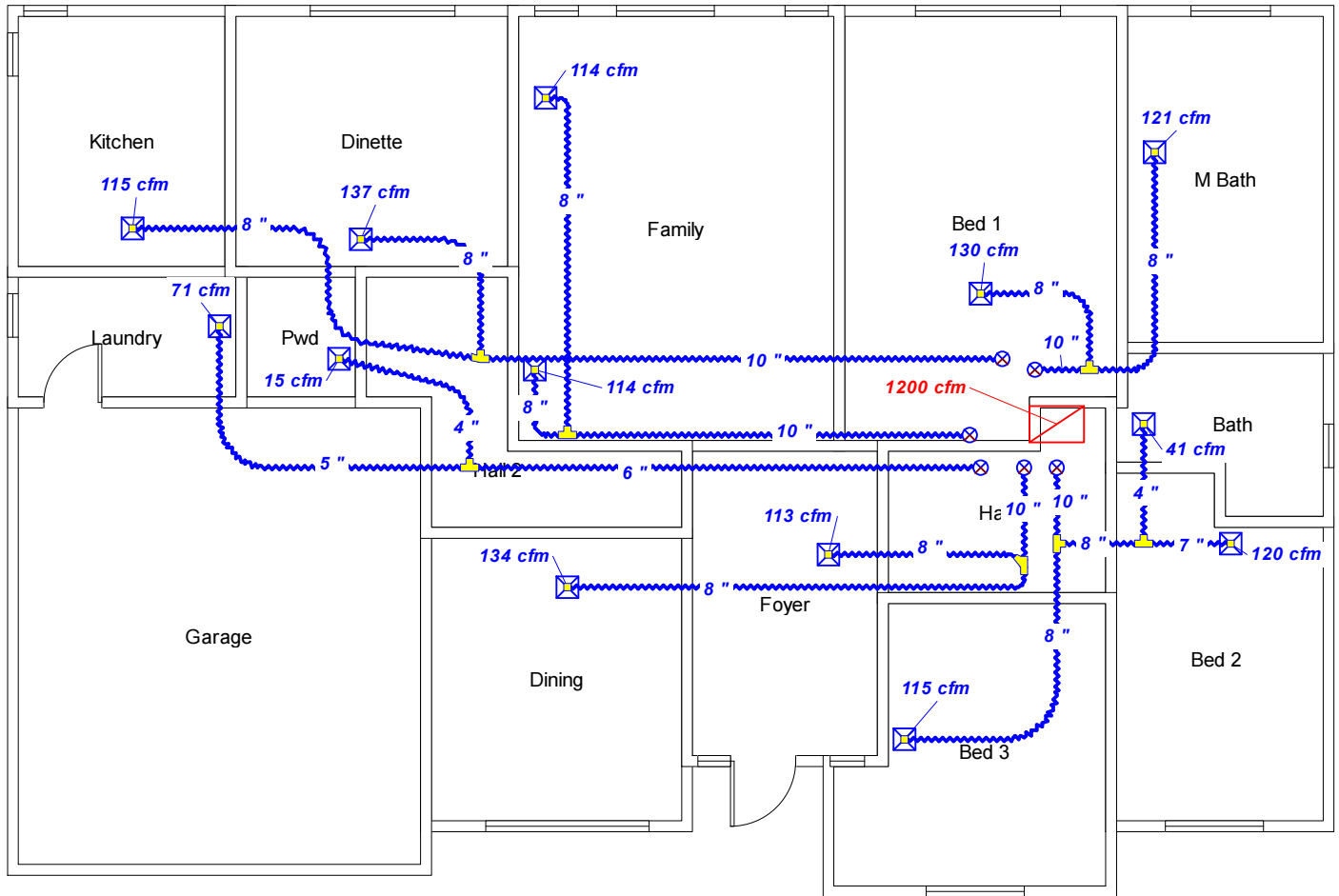

Job #:
Performed by ME for:
AHRI Project No. 8002
on the Life Cycle of Residential HVAC Systems
Home #1, Flex Duct

Austin Air Conditioning, Inc.
13620 Immanuel Rd
Pflugerville, TX 78660
Phone: 512-252-7711 Fax: 512-252-7744
www.austinaircond.com info@austinairconditioning.c...

Scale: 1 : 101
Page 1
Right-Suite@ Universal 2012
12.1.08 RSU15282
2013-Sep-18 15:52:01
...02\Home #1 Flex 1 .15-.50 SP.rup



Basement

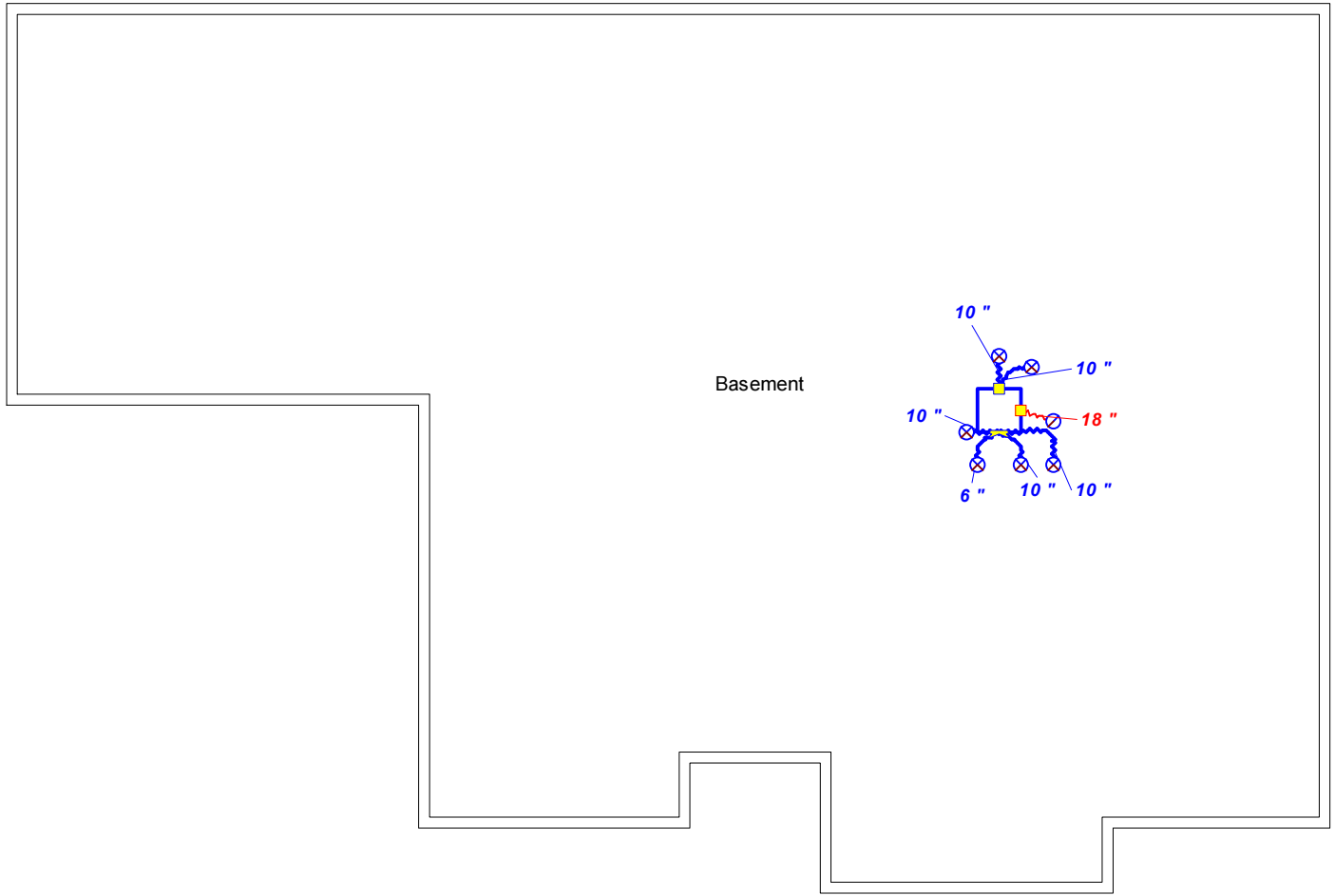

Job #:
Performed by ME for:
AHRI Project No. 8002
on the Life Cycle of Residential HVAC Systems
Home #1, Flex Duct

Austin Air Conditioning, Inc.
13620 Immanuel Rd
Pflugerville, TX 78660
Phone: 512-252-7711 Fax: 512-252-7744
www.austinaircond.com info@austinairconditioning.c...

Scale: 1 : 101
Page 2
Right-Suite@ Universal 2012
12.1.08 RSU15282
2013-Sep-18 15:52:01
...02\Home #1 Flex 1 .15-.50 SP.rup



Project Summary
Entire House
 Austin Air Conditioning, Inc.

Job:
 Date: 7/31/13
 By: ME

13620 Immanuel Rd., Pflugerville, TX 78660 Phone: 512-252-7711 Fax: 512-252-7744 Email: info@austinairconditioning.com Web: www.austinaircond.com License: TACLB2314...

Project Information

For: AHRI Project No. 8002, The Impact of Duct Design on the Life Cycle of Residential HVAC Systems, Home #1, Flex Duct

Notes: R-21 WALLS, R-38 ATTIC, R-30 FLOOR OVER BASEMENT, .55 U-VALUE, .35 SHGC WINDOWS, FRONT DOOR FACES EAST

Design Information

Weather: Chicago Midway AP, IL, US

Winter Design Conditions

Outside db 4 °F
 Inside db 70 °F
 Design TD 66 °F

Summer Design Conditions

Outside db 92 °F
 Inside db 75 °F
 Design TD 17 °F
 Daily range L
 Relative humidity 50 %
 Moisture difference 40 gr/lb

Heating Summary

Structure 31001 Btuh
 Ducts 1425 Btuh
 Central vent (0 cfm) 0 Btuh
 Humidification 0 Btuh
 Piping 0 Btuh
 Equipment load 32426 Btuh

Sensible Cooling Equipment Load Sizing

Structure 18715 Btuh
 Ducts 503 Btuh
 Central vent (0 cfm) 0 Btuh
 Blower 0 Btuh
 Use manufacturer's data y
 Rate/swing multiplier 1.00
 Equipment sensible load 19218 Btuh

Infiltration

Method Simplified
 Construction quality Average
 Fireplaces 0

	Heating	Cooling
Area (ft ²)	1918	1918
Volume (ft ³)	18101	18101
Air changes/hour	0.38	0.20
Equiv. AVF (cfm)	115	60

Latent Cooling Equipment Load Sizing

Structure 2797 Btuh
 Ducts 647 Btuh
 Central vent (0 cfm) 0 Btuh
 Equipment latent load 3443 Btuh
 Equipment total load 22661 Btuh
 Req. total capacity at 0.78 SHR 2.1 ton

Heating Equipment Summary

Make Generic
 Trade
 Model 96% AFUE FURNACE
 AHRI ref

Efficiency	96 AFUE
Heating input	42790 MBtuh
Heating output	68000 Btuh
Temperature rise	53 °F
Actual air flow	1200 cfm
Air flow factor	0.037 cfm/Btuh
Static pressure	0.80 in H2O
Space thermostat	

Cooling Equipment Summary

Make GENERIC
 Trade
 Cond 3.0 TON AC
 Coil
 AHRI ref
 Efficiency 12.5 EER, 16 SEER

Sensible cooling	28000 Btuh
Latent cooling	8000 Btuh
Total cooling	36000 Btuh
Actual air flow	1200 cfm
Air flow factor	0.062 cfm/Btuh
Static pressure	0.80 in H2O
Load sensible heat ratio	0.85

Calculations approved by ACCA to meet all requirements of Manual J 8th Ed.





Duct System Summary

Entire House

Austin Air Conditioning, Inc.

Job:
Date: 7/31/13
By: ME

13620 Immanuel Rd, Pflugerville, TX 78660 Phone: 512-252-7711 Fax: 512-252-7744 Email: info@austinairconditioning.com Web: www.austinaircond.com License: TACLB2314...

Project Information

For: AHRI Project No. 8002, The Impact of Duct Design
on the Life Cycle of Residential HVAC Systems, Home #1, Flex Duct

	Heating	Cooling
External static pressure	0.80 in H2O	0.80 in H2O
Pressure losses	0.35 in H2O	0.35 in H2O
Available static pressure	0.45 in H2O	0.45 in H2O
Supply / return available pressure	0.32 / 0.13 in H2O	0.32 / 0.13 in H2O
Lowest friction rate	0.173 in/100ft	0.173 in/100ft
Actual air flow	1200 cfm	1200 cfm
Total effective length (TEL)		260 ft

Supply Branch Detail Table

Name	Design (Btuh)	Htg (cfm)	Clg (cfm)	Design FR	Diam (in)	H x W (in)	Duct Matl	Actual Ln (ft)	Ftg.Eqv Ln (ft)	Trunk
Bath	h 1108	41	19	0.226	4.0	0x0	VIFx	18.6	124.0	st10
Bed 1	c 2081	102	130	0.231	6.0	0x0	VIFx	15.0	124.0	st7
Bed 2	h 3253	120	85	0.216	7.0	0x0	VIFx	20.2	129.0	st10
Bed 3	h 3114	115	85	0.215	7.0	0x0	VIFx	25.6	124.0	st10
Dinette	c 2189	112	137	0.189	8.0	0x0	VIFx	38.6	132.0	st8
Dining	h 3613	134	116	0.211	7.0	0x0	VIFx	30.6	122.0	st11
Family	c 1828	89	114	0.191	6.0	0x0	VIFx	39.4	129.0	st6
Family-A	c 1828	89	114	0.206	6.0	0x0	VIFx	27.4	129.0	st6
Foyer	c 1812	101	113	0.230	6.0	0x0	VIFx	17.7	122.0	st11
Kitchen	c 1838	94	115	0.173	7.0	0x0	VIFx	48.6	137.0	st8
Laundry	c 1131	67	71	0.189	5.0	0x0	VIFx	45.8	124.0	st9
M Bath	h 3275	121	94	0.224	6.0	0x0	VIFx	19.5	124.0	st7
Pwd	h 398	15	7	0.198	4.0	0x0	VIFx	38.4	124.0	st9

Bold/italic values have been manually overridden

Supply Trunk Detail Table

Name	Trunk Type	Htg (cfm)	Clg (cfm)	Design FR	Veloc (fpm)	Diam (in)	H x W (in)	Duct Material	Trunk
st10	Peak AVF	277	189	0.215	507	10.0	0 x 0	VinlFix	st4
st7	Peak AVF	223	224	0.224	643	8.0	0 x 0	VinlFix	st1
st3	Peak AVF	82	77	0.189	416	6.0	0 x 0	VinlFix	
st1	Peak AVF	223	224	0.224	643	8.0	0 x 0	VinlFix	
st2	Peak AVF	206	251	0.173	461	10.0	0 x 0	VinlFix	
st4	Peak AVF	277	189	0.215	507	10.0	0 x 0	VinlFix	
st5	Peak AVF	235	229	0.211	672	8.0	0 x 0	VinlFix	
st6	Peak AVF	179	228	0.191	654	8.0	0 x 0	VinlFix	
st11	Peak AVF	235	229	0.211	531	9.0	0 x 0	VinlFix	st5
st8	Peak AVF	206	251	0.173	461	10.0	0 x 0	VinlFix	st2
st9	Peak AVF	82	77	0.189	416	6.0	0 x 0	VinlFix	st3

Return Branch Detail Table

Name	Grill Size (in)	Htg (cfm)	Clg (cfm)	TEL (ft)	Design FR	Veloc (fpm)	Diam (in)	H x W (in)	Stud/Joist Opening (in)	Duct Matl	Trunk
rb1	0x0	1200	1200	74.0	0.173	679	18.0	0x 0		VIFx	

Bold/italic values have been manually overridden



1ST FLOOR

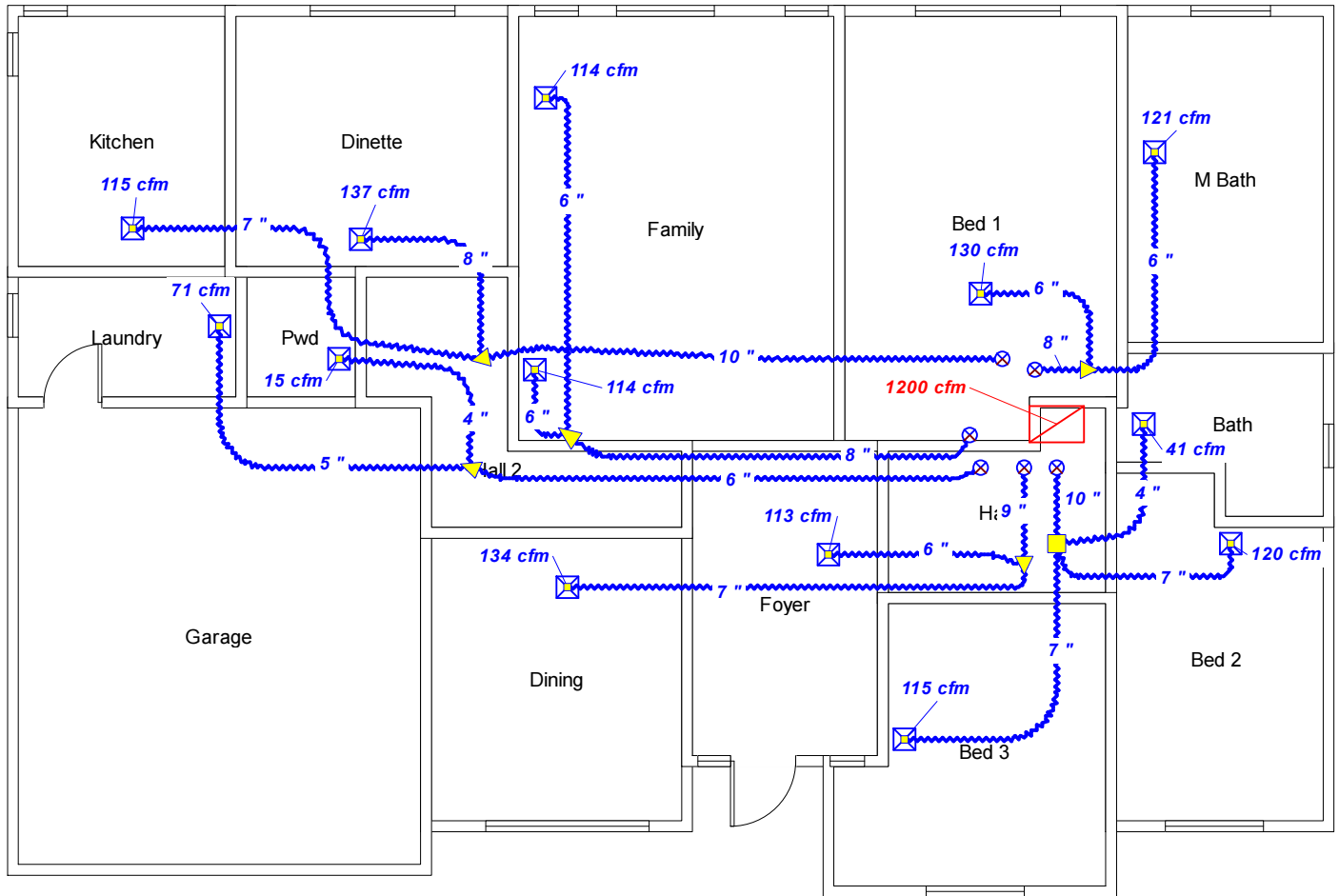

Job #:
Performed by ME for:
AHRI Project No. 8002
on the Life Cycle of Residential HVAC Systems
Home #1, Flex Duct

Austin Air Conditioning, Inc.
13620 Immanuel Rd
Pflugerville, TX 78660
Phone: 512-252-7711 Fax: 512-252-7744
www.austinaircond.com info@austinairconditioning.c...

Scale: 1 : 101
Page 1
Right-Suite® Universal 2012
12.1.08 RSU15282
2013-Sep-18 15:52:44
...02\Home #1 Flex 2 .45-.80 SP.rup



Basement

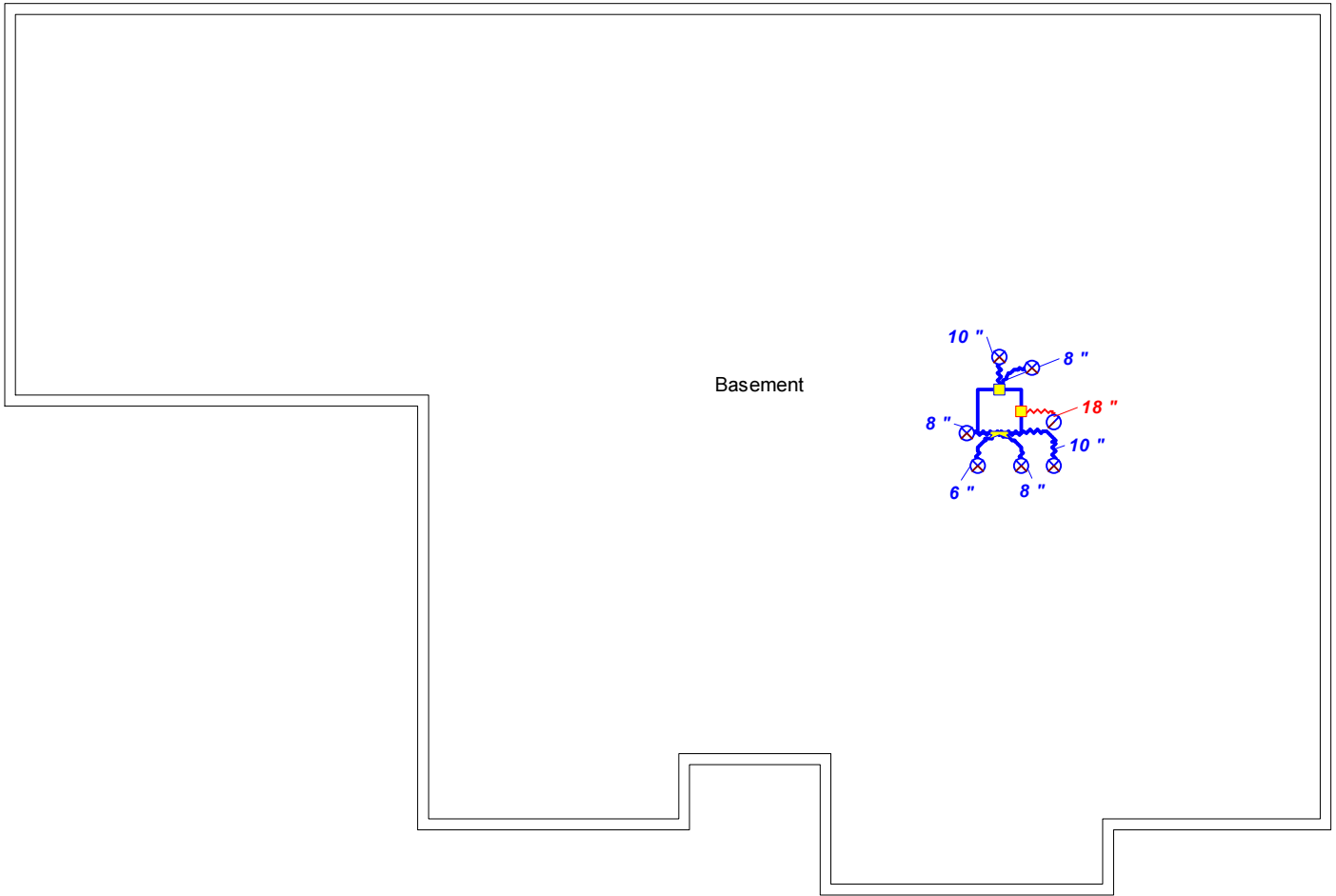

Job #:
Performed by ME for:
AHRI Project No. 8002
on the Life Cycle of Residential HVAC Systems
Home #1, Flex Duct

Austin Air Conditioning, Inc.
13620 Immanuel Rd
Pflugerville, TX 78660
Phone: 512-252-7711 Fax: 512-252-7744
www.austinaircond.com info@austinairconditioning.c...

Scale: 1 : 101
Page 2
Right-Suite@ Universal 2012
12.1.08 RSU15282
2013-Sep-18 15:52:44
...02\Home #1 Flex 2 .45-.80 SP.rup



Project Summary
Entire House
 Austin Air Conditioning, Inc.

Job:
 Date: 9/16/13
 By: ME

13620 Immanuel Rd., Pflugerville, TX 78660 Phone: 512-252-7711 Fax: 512-252-7744 Email: info@austinairconditioning.com Web: www.austinaircond.com License: TACLB2314...

Project Information

For: AHRI Project No. 8002, The Impact of Duct Design on the Life Cycle of Residential HVAC Systems, Home #1, Flex Duct

Notes: R-21 WALLS, R-38 ATTIC, R-30 FLOOR OVER BASEMENT, .55 U-VALUE, .35 SHGC WINDOWS, FRONT DOOR FACES EAST

Design Information

Weather: Chicago Midway AP, IL, US

Winter Design Conditions

Outside db 4 °F
 Inside db 70 °F
 Design TD 66 °F

Summer Design Conditions

Outside db 92 °F
 Inside db 75 °F
 Design TD 17 °F
 Daily range L
 Relative humidity 50 %
 Moisture difference 40 gr/lb

Heating Summary

Structure 31001 Btuh
 Ducts 1425 Btuh
 Central vent (0 cfm) 0 Btuh
 Humidification 0 Btuh
 Piping 0 Btuh
 Equipment load 32426 Btuh

Sensible Cooling Equipment Load Sizing

Structure 18715 Btuh
 Ducts 503 Btuh
 Central vent (0 cfm) 0 Btuh
 Blower 0 Btuh
 Use manufacturer's data y
 Rate/swing multiplier 1.00
 Equipment sensible load 19218 Btuh

Infiltration

Method Simplified
 Construction quality Average
 Fireplaces 0

	Heating	Cooling
Area (ft ²)	1918	1918
Volume (ft ³)	18101	18101
Air changes/hour	0.38	0.20
Equiv. AVF (cfm)	115	60

Latent Cooling Equipment Load Sizing

Structure 2797 Btuh
 Ducts 647 Btuh
 Central vent (0 cfm) 0 Btuh
 Equipment latent load 3443 Btuh
 Equipment total load 22661 Btuh
 Req. total capacity at 0.78 SHR 2.1 ton

Heating Equipment Summary

Make Generic
 Trade
 Model 96% AFUE FURNACE
 AHRI ref

Efficiency	96 AFUE
Heating input	42790 MBtuh
Heating output	68000 Btuh
Temperature rise	53 °F
Actual air flow	1200 cfm
Air flow factor	0.037 cfm/Btuh
Static pressure	1.10 in H2O
Space thermostat	

Cooling Equipment Summary

Make GENERIC
 Trade
 Cond 3.0 TON AC
 Coil
 AHRI ref
 Efficiency 12.5 EER, 16 SEER

Sensible cooling	28000 Btuh
Latent cooling	8000 Btuh
Total cooling	36000 Btuh
Actual air flow	1200 cfm
Air flow factor	0.062 cfm/Btuh
Static pressure	1.10 in H2O
Load sensible heat ratio	0.85

Calculations approved by ACCA to meet all requirements of Manual J 8th Ed.





Duct System Summary

Entire House

Austin Air Conditioning, Inc.

Job:
Date: 9/16/13
By: ME

13620 Immanuel Rd, Pflugerville, TX 78660 Phone: 512-252-7711 Fax: 512-252-7744 Email: info@austinairconditioning.com Web: www.austinaircond.com License: TACLB2314...

Project Information

For: AHRI Project No. 8002, The Impact of Duct Design
on the Life Cycle of Residential HVAC Systems, Home #1, Flex Duct

	Heating	Cooling
External static pressure	1.10 in H2O	1.10 in H2O
Pressure losses	0.35 in H2O	0.35 in H2O
Available static pressure	0.75 in H2O	0.75 in H2O
Supply / return available pressure	0.61 / 0.14 in H2O	0.61 / 0.14 in H2O
Lowest friction rate	0.178 in/100ft	0.178 in/100ft
Actual air flow	1200 cfm	1200 cfm
Total effective length (TEL)		421 ft

Supply Branch Detail Table

Name	Design (Btuh)	Htg (cfm)	Clg (cfm)	Design FR	Diam (in)	H x W (in)	Duct Matl	Actual Ln (ft)	Ftg.Eqv Ln (ft)	Trunk
Bath	h 1108	41	19	0.213	4.0	0x0	VIFx	25.8	259.0	st13
Bed 1	c 1041	51	65	0.301	5.0	0x0	VIFx	7.5	194.0	
Bed 1-A	c 1041	51	65	0.286	5.0	0x0	VIFx	17.8	194.0	
Bed 2	h 3253	120	85	0.225	7.0	0x0	VIFx	20.9	249.0	st13
Bed 3	h 3114	115	85	0.273	7.0	0x0	VIFx	17.1	205.0	
Dinette	c 2189	112	137	0.188	8.0	0x0	VIFx	39.0	284.0	st11
Dining	h 3613	134	116	0.185	7.0	0x0	VIFx	34.6	294.0	st14
Family	c 1828	89	114	0.236	7.0	0x0	VIFx	36.6	220.0	
Family-A	c 1828	89	114	0.280	7.0	0x0	VIFx	26.5	190.0	
Foyer	c 1812	101	113	0.202	7.0	0x0	VIFx	21.7	279.0	st14
Kitchen	c 1838	94	115	0.178	7.0	0x0	VIFx	51.0	289.0	st11
Laundry	c 1131	67	71	0.193	6.0	0x0	VIFx	57.0	257.0	st12
M Bath	h 3275	121	94	0.260	7.0	0x0	VIFx	19.6	214.0	
Pwd	h 398	15	7	0.197	4.0	0x0	VIFx	50.5	257.0	st12

Bold/italic values have been manually overridden

Supply Trunk Detail Table

Name	Trunk Type	Htg (cfm)	Clg (cfm)	Design FR	Veloc (fpm)	Diam (in)	H x W (in)	Duct Material	Trunk
st13	Peak AVF	161	105	0.213	462	8.0	0 x 0	VinlFix	st7
st6	Peak AVF	82	77	0.193	416	6.0	0 x 0	VinlFix	
st4	Peak AVF	206	251	0.178	461	10.0	0 x 0	VinlFix	
st7	Peak AVF	161	105	0.213	462	8.0	0 x 0	VinlFix	
st8	Peak AVF	235	229	0.185	430	10.0	0 x 0	VinlFix	
st14	Peak AVF	235	229	0.185	531	9.0	0 x 0	VinlFix	st8
st11	Peak AVF	206	251	0.178	461	10.0	0 x 0	VinlFix	st4
st12	Peak AVF	82	77	0.193	306	7.0	0 x 0	VinlFix	st6

Return Branch Detail Table

Name	Grill Size (in)	Htg (cfm)	Clg (cfm)	TEL (ft)	Design FR	Veloc (fpm)	Diam (in)	H x W (in)	Stud/Joist Opening (in)	Duct Matl	Trunk
rb1	0x0	1200	1200	80.5	0.178	679	18.0	0x 0		VIFx	

Bold/italic values have been manually overridden



1ST FLOOR

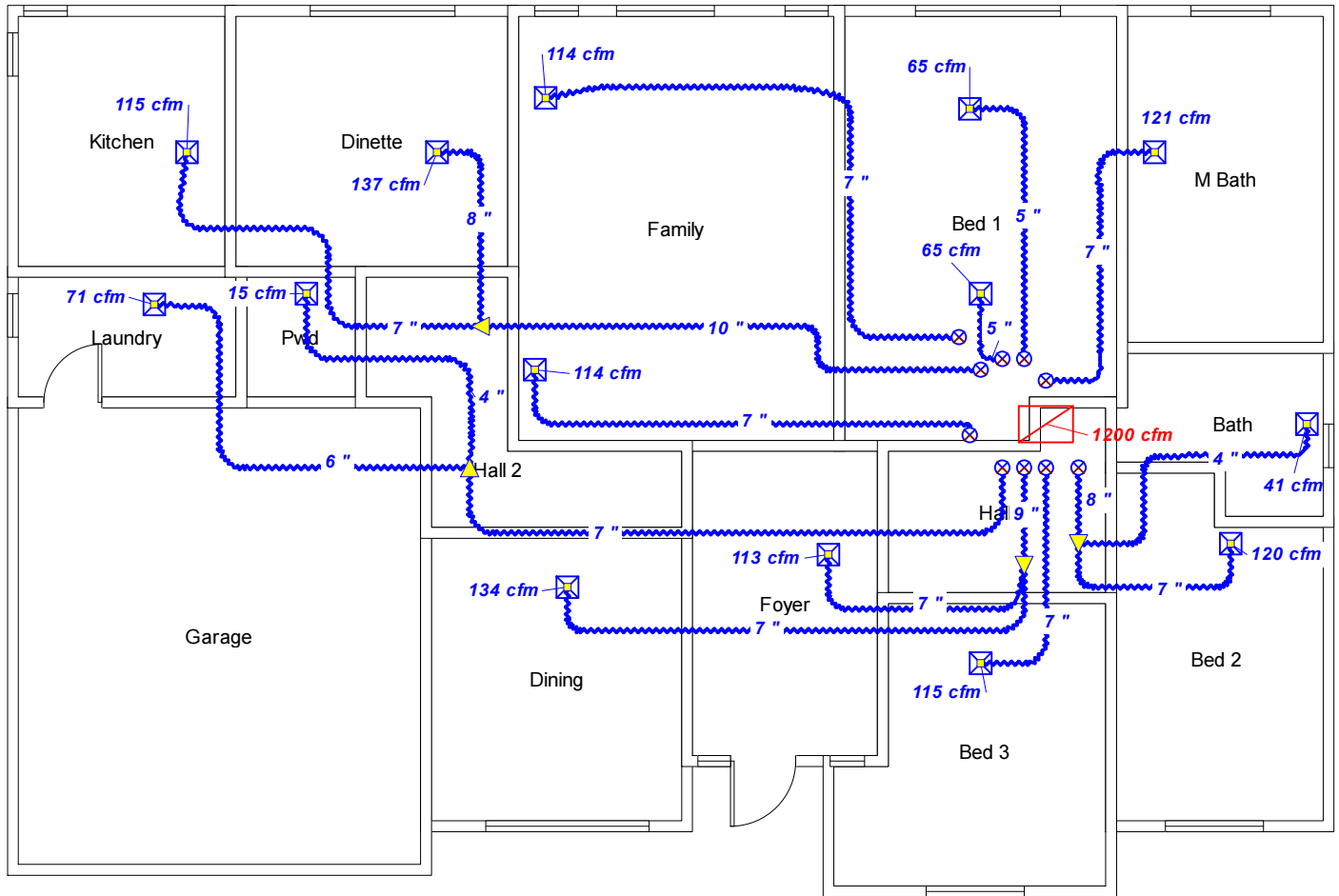

Job #:
Performed by ME for:
AHRI Project No. 8002
on the Life Cycle of Residential HVAC Systems
Home #1, Flex Duct

Austin Air Conditioning, Inc.
13620 Immanuel Rd
Pflugerville, TX 78660
Phone: 512-252-7711 Fax: 512-252-7744
www.austinaircond.com info@austinairconditioning.c...

Scale: 1 : 101
Page 1
Right-Suite@ Universal 2012
12.1.08 RSU15282
2013-Sep-18 15:49:40
...2\Home #1 Flex 3 .75-1.10 SP.rup



Basement

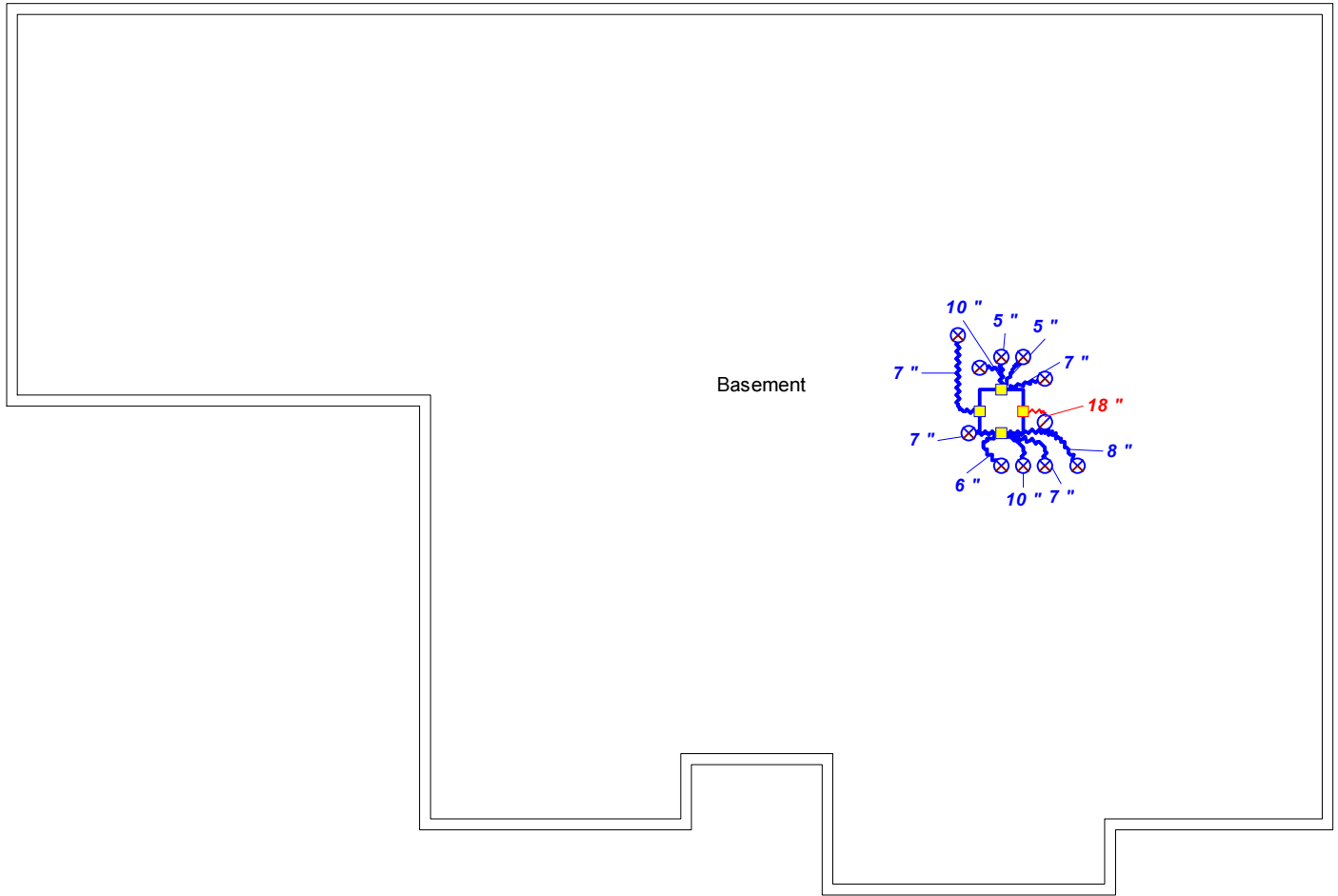

Job #:
Performed by ME for:
AHRI Project No. 8002
on the Life Cycle of Residential HVAC Systems
Home #1, Flex Duct

Austin Air Conditioning, Inc.
13620 Immanuel Rd
Pflugerville, TX 78660
Phone: 512-252-7711 Fax: 512-252-7744
www.austinaircond.com info@austinairconditioning.c...

Scale: 1 : 101
Page 2
Right-Suite@ Universal 2012
12.1.08 RSU15282
2013-Sep-18 15:49:40
...2\Home #1 Flex 3 .75-1.10 SP.rup



Project Summary
Entire House
 Austin Air Conditioning, Inc.

Job:
 Date: 7/31/13
 By: ME

13620 Immanuel Rd., Pflugerville, TX 78660 Phone: 512-252-7711 Fax: 512-252-7744 Email: info@austinairconditioning.com Web: www.austinaircond.com License: TACL2314...

Project Information

For: AHRI Project No. 8002, The Impact of Duct Design on the Life Cycle of Residential HVAC Systems, Home #1, Round Metal Duct

Notes: R-21 WALLS, R-38 ATTIC, R-30 FLOOR OVER BASEMENT, .55 U-VALUE, .35 SHGC WINDOWS, FRONT DOOR FACES EAST

Design Information

Weather: Chicago Midway AP, IL, US

Winter Design Conditions

Outside db 4 °F
 Inside db 70 °F
 Design TD 66 °F

Summer Design Conditions

Outside db 92 °F
 Inside db 75 °F
 Design TD 17 °F
 Daily range L
 Relative humidity 50 %
 Moisture difference 40 gr/lb

Heating Summary

Structure 31001 Btuh
 Ducts 1425 Btuh
 Central vent (0 cfm) 0 Btuh
 Humidification 0 Btuh
 Piping 0 Btuh
 Equipment load 32426 Btuh

Sensible Cooling Equipment Load Sizing

Structure 18715 Btuh
 Ducts 503 Btuh
 Central vent (0 cfm) 0 Btuh
 Blower 0 Btuh
 Use manufacturer's data y
 Rate/swing multiplier 1.00
 Equipment sensible load 19218 Btuh

Infiltration

Method Simplified
 Construction quality Average
 Fireplaces 0

	Heating	Cooling
Area (ft ²)	1918	1918
Volume (ft ³)	18101	18101
Air changes/hour	0.38	0.20
Equiv. AVF (cfm)	115	60

Latent Cooling Equipment Load Sizing

Structure 2797 Btuh
 Ducts 647 Btuh
 Central vent (0 cfm) 0 Btuh
 Equipment latent load 3443 Btuh
 Equipment total load 22661 Btuh
 Req. total capacity at 0.78 SHR 2.1 ton

Heating Equipment Summary

Make Generic
 Trade
 Model 96% AFUE FURNACE
 AHRI ref

Efficiency	96 AFUE
Heating input	42790 MBtuh
Heating output	68000 Btuh
Temperature rise	53 °F
Actual air flow	1200 cfm
Air flow factor	0.037 cfm/Btuh
Static pressure	0.50 in H2O
Space thermostat	

Cooling Equipment Summary

Make GENERIC
 Trade
 Cond 3.0 TON AC
 Coil
 AHRI ref
 Efficiency 12.5 EER, 16 SEER

Sensible cooling	28000 Btuh
Latent cooling	8000 Btuh
Total cooling	36000 Btuh
Actual air flow	1200 cfm
Air flow factor	0.062 cfm/Btuh
Static pressure	0.50 in H2O
Load sensible heat ratio	0.85

Calculations approved by ACCA to meet all requirements of Manual J 8th Ed.





Duct System Summary

Entire House

Austin Air Conditioning, Inc.

Job:
Date: 7/31/13
By: ME

13620 Immanuel Rd, Pflugerville, TX 78660 Phone: 512-252-7711 Fax: 512-252-7744 Email: info@austinairconditioning.com Web: www.austinaircond.com License: TACLB2314...

Project Information

For: AHRI Project No. 8002, The Impact of Duct Design
on the Life Cycle of Residential HVAC Systems, Home #1, Round Metal Duct

	Heating	Cooling
External static pressure	0.50 in H2O	0.50 in H2O
Pressure losses	0.35 in H2O	0.35 in H2O
Available static pressure	0.15 in H2O	0.15 in H2O
Supply / return available pressure	0.08 / 0.07 in H2O	0.08 / 0.07 in H2O
Lowest friction rate	0.039 in/100ft	0.039 in/100ft
Actual air flow	1200 cfm	1200 cfm
Total effective length (TEL)	383 ft	

Supply Branch Detail Table

Name	Design (Btuh)	Htg (cfm)	Clg (cfm)	Design FR	Diam (in)	H x W (in)	Duct Matl	Actual Ln (ft)	Ftg.Eqv Ln (ft)	Trunk
Bath	h 1108	41	19	0.054	4.0	0x0	ShMt	9.3	140.0	st5
Bed 1	c 2081	102	130	0.056	8.0	0x0	ShMt	6.8	135.0	st1
Bed 2	h 3253	120	85	0.052	8.0	0x0	ShMt	20.0	135.0	st3
Bed 3	h 3114	115	85	0.047	8.0	0x0	ShMt	21.0	150.0	st2
Dinette	c 2189	112	137	0.039	8.0	0x0	ShMt	44.0	160.0	st12
Dining	h 3613	134	116	0.041	8.0	0x0	ShMt	29.5	165.0	st10
Family	c 1828	89	114	0.040	8.0	0x0	ShMt	22.5	175.0	st2
Family-A	c 1828	89	114	0.049	8.0	0x0	ShMt	11.5	150.0	st8
Foyer	c 1812	101	113	0.040	8.0	0x0	ShMt	25.0	175.0	st9
Kitchen	c 1838	94	115	0.041	8.0	0x0	ShMt	47.0	150.0	st13
Laundry	c 1131	67	71	0.045	6.0	0x0	ShMt	38.0	140.0	st15
M Bath	h 3275	121	94	0.055	8.0	0x0	ShMt	19.5	125.0	st4
Pwd	h 398	15	7	0.047	4.0	0x0	ShMt	30.6	140.0	st16

Supply Trunk Detail Table

Name	Trunk Type	Htg (cfm)	Clg (cfm)	Design FR	Veloc (fpm)	Diam (in)	H x W (in)	Duct Material	Trunk
st5	Peak AVF	41	19	0.054	470	4.0	0 x 0	ShtMetl	st4
st4	Peak AVF	162	114	0.054	465	8.0	0 x 0	ShtMetl	st3
st2	Peak AVF	816	871	0.039	624	16.0	0 x 0	ShtMetl	
st10	Peak AVF	421	445	0.039	416	14.0	0 x 0	ShtMetl	st9
st9	Peak AVF	522	558	0.039	522	14.0	0 x 0	ShtMetl	st8
st13	Peak AVF	176	192	0.041	352	10.0	0 x 0	ShtMetl	st12
st16	Peak AVF	15	7	0.047	169	4.0	0 x 0	ShtMetl	st15
st15	Peak AVF	82	77	0.045	416	6.0	0 x 0	ShtMetl	st13
st3	Peak AVF	283	199	0.052	518	10.0	0 x 0	ShtMetl	st1
st1	Peak AVF	384	329	0.052	489	12.0	0 x 0	ShtMetl	
st12	Peak AVF	287	329	0.039	419	12.0	0 x 0	ShtMetl	st10
st8	Peak AVF	611	672	0.039	481	16.0	0 x 0	ShtMetl	st2

Return Branch Detail Table

Name	Grill Size (in)	Htg (cfm)	Clg (cfm)	TEL (ft)	Design FR	Veloc (fpm)	Diam (in)	H x W (in)	Stud/Joist Opening (in)	Duct Matl	Trunk
rb1	0x0	1200	1200	179.0	0.039	600	17.8	16x 18		ShMt	



1ST FLOOR

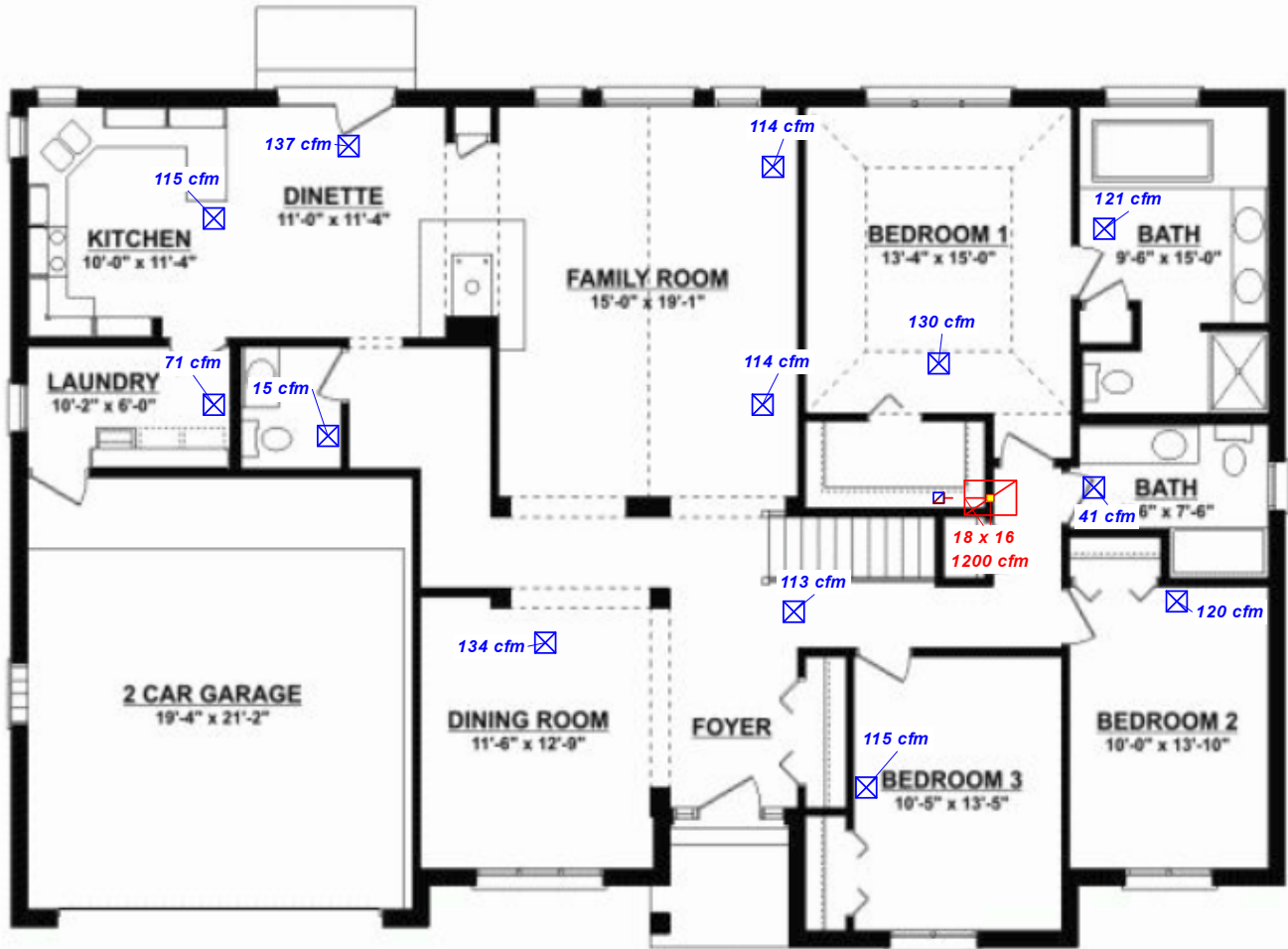

Job #:
Performed by ME for:
AHRI Project No. 8002
on the Life Cycle of Residential HVAC Systems
Home #1, Round Metal Duct

Austin Air Conditioning, Inc.
13620 Immanuel Rd
Pflugerville, TX 78660
Phone: 512-252-7711 Fax: 512-252-7744
www.austinaircond.com info@austinairconditioning.com

Scale: 1 : 111
Page 1
Right-Suite© Universal 2012
12.1.08 RSU15282
2013-Aug-05 13:10:22
...2\Home #1 Metal 1 .15-.50 SP.rup

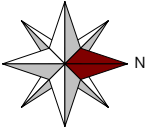

Basement

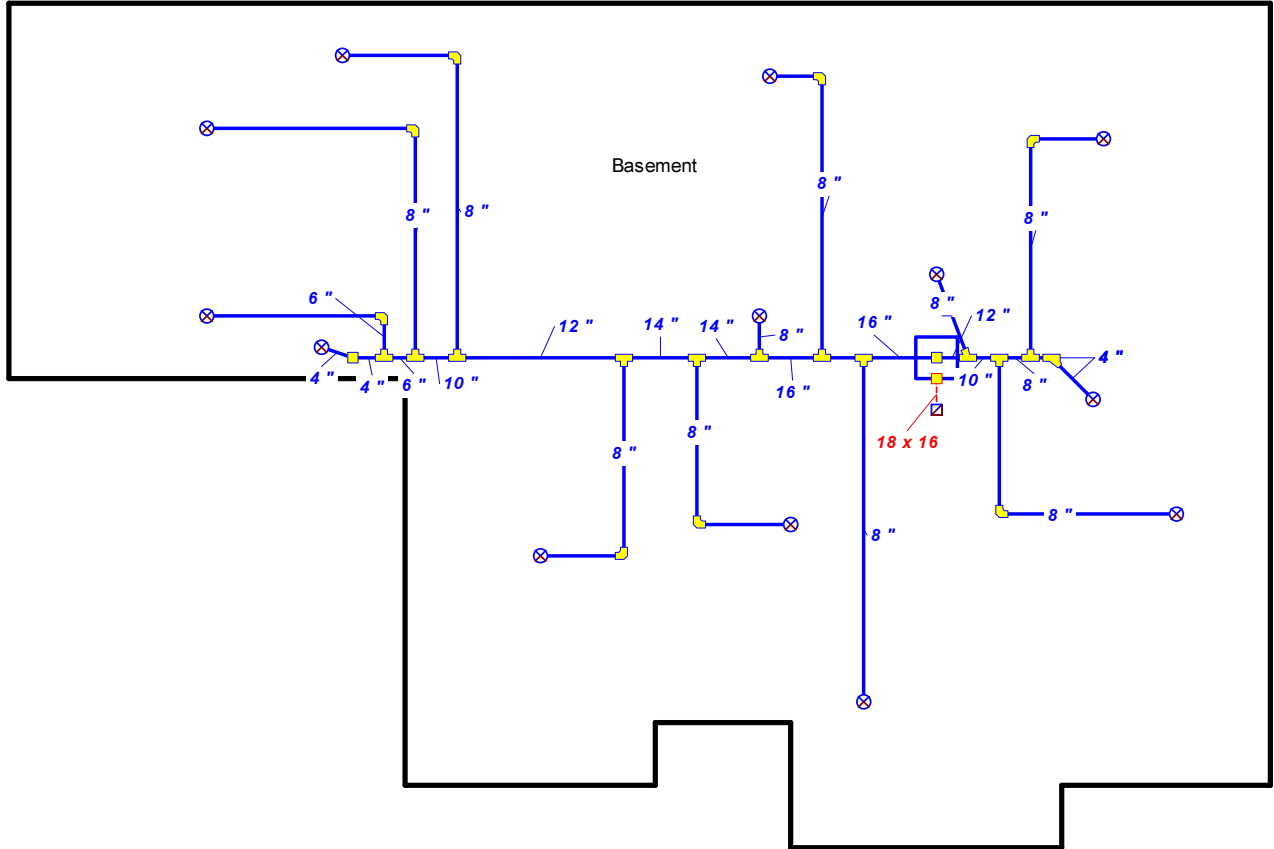

Job #:
Performed by ME for:
AHRI Project No. 8002
on the Life Cycle of Residential HVAC Systems
Home #1, Round Metal Duct

Austin Air Conditioning, Inc.
13620 Immanuel Rd
Pflugerville, TX 78660
Phone: 512-252-7711 Fax: 512-252-7744
www.austinaircond.com info@austinairconditioning.com

Scale: 1 : 111
Page 2
Right-Suite© Universal 2012
12.1.08 RSU15282
2013-Aug-05 13:10:22
...2\Home #1 Metal 1.15-.50 SPrup



Project Summary
Entire House
 Austin Air Conditioning, Inc.

Job:
 Date: 7/31/13
 By: ME

13620 Immanuel Rd., Pflugerville, TX 78660 Phone: 512-252-7711 Fax: 512-252-7744 Email: info@austinairconditioning.com Web: www.austinaircond.com License: TACLB2314...

Project Information

For: AHRI Project No. 8002, The Impact of Duct Design on the Life Cycle of Residential HVAC Systems, Home #1, Round Metal Duct

Notes: R-21 WALLS, R-38 ATTIC, R-30 FLOOR OVER BASEMENT, .55 U-VALUE, .35 SHGC WINDOWS, FRONT DOOR FACES EAST

Design Information

Weather: Chicago Midway AP, IL, US

Winter Design Conditions

Outside db 4 °F
 Inside db 70 °F
 Design TD 66 °F

Summer Design Conditions

Outside db 92 °F
 Inside db 75 °F
 Design TD 17 °F
 Daily range L
 Relative humidity 50 %
 Moisture difference 40 gr/lb

Heating Summary

Structure 31001 Btuh
 Ducts 1425 Btuh
 Central vent (0 cfm) 0 Btuh
 Humidification 0 Btuh
 Piping 0 Btuh
 Equipment load 32426 Btuh

Sensible Cooling Equipment Load Sizing

Structure 18715 Btuh
 Ducts 503 Btuh
 Central vent (0 cfm) 0 Btuh
 Blower 0 Btuh
 Use manufacturer's data y
 Rate/swing multiplier 1.00
 Equipment sensible load 19218 Btuh

Infiltration

Method Simplified
 Construction quality Average
 Fireplaces 0

	Heating	Cooling
Area (ft ²)	1918	1918
Volume (ft ³)	18101	18101
Air changes/hour	0.38	0.20
Equiv. AVF (cfm)	115	60

Latent Cooling Equipment Load Sizing

Structure 2797 Btuh
 Ducts 647 Btuh
 Central vent (0 cfm) 0 Btuh
 Equipment latent load 3443 Btuh
 Equipment total load 22661 Btuh
 Req. total capacity at 0.78 SHR 2.1 ton

Heating Equipment Summary

Make Generic
 Trade
 Model 96% AFUE FURNACE
 AHRI ref

Efficiency	96 AFUE
Heating input	42790 MBtuh
Heating output	68000 Btuh
Temperature rise	53 °F
Actual air flow	1200 cfm
Air flow factor	0.037 cfm/Btuh
Static pressure	0.80 in H2O
Space thermostat	

Cooling Equipment Summary

Make GENERIC
 Trade
 Cond 3.0 TON AC
 Coil
 AHRI ref
 Efficiency 12.5 EER, 16 SEER

Sensible cooling	28000 Btuh
Latent cooling	8000 Btuh
Total cooling	36000 Btuh
Actual air flow	1200 cfm
Air flow factor	0.062 cfm/Btuh
Static pressure	0.80 in H2O
Load sensible heat ratio	0.85

Calculations approved by ACCA to meet all requirements of Manual J 8th Ed.





Duct System Summary

Entire House

Austin Air Conditioning, Inc.

Job:
Date: 7/31/13
By: ME

13620 Immanuel Rd, Pflugerville, TX 78660 Phone: 512-252-7711 Fax: 512-252-7744 Email: info@austinairconditioning.com Web: www.austinaircond.com License: TACL2314...

Project Information

For: AHRI Project No. 8002, The Impact of Duct Design
on the Life Cycle of Residential HVAC Systems, Home #1, Round Metal Duct

	Heating	Cooling
External static pressure	0.80 in H2O	0.80 in H2O
Pressure losses	0.35 in H2O	0.35 in H2O
Available static pressure	0.45 in H2O	0.45 in H2O
Supply / return available pressure	0.21 / 0.24 in H2O	0.21 / 0.24 in H2O
Lowest friction rate	0.102 in/100ft	0.102 in/100ft
Actual air flow	1200 cfm	1200 cfm
Total effective length (TEL)	443 ft	

Supply Branch Detail Table

Name	Design (Btuh)	Htg (cfm)	Clg (cfm)	Design FR	Diam (in)	H x W (in)	Duct Matl	Actual Ln (ft)	Ftg.Eqv Ln (ft)	Trunk
Bath	h 1108	41	19	0.139	4.0	0x0	ShMt	9.3	140.0	st5
Bed 1	c 2081	102	130	0.146	8.0	0x0	ShMt	6.8	135.0	st1
Bed 2	h 3253	120	85	0.122	8.0	0x0	ShMt	20.0	150.0	st3
Bed 3	h 3114	115	85	0.121	8.0	0x0	ShMt	21.0	150.0	st2
Dinette	c 2189	112	137	0.102	8.0	0x0	ShMt	44.0	160.0	st12
Dining	h 3613	134	116	0.107	8.0	0x0	ShMt	29.5	165.0	st10
Family	c 1828	89	114	0.105	8.0	0x0	ShMt	22.5	175.0	st2
Family-A	c 1828	89	114	0.128	8.0	0x0	ShMt	11.5	150.0	st8
Foyer	c 1812	101	113	0.104	8.0	0x0	ShMt	25.0	175.0	st9
Kitchen	c 1838	94	115	0.105	8.0	0x0	ShMt	47.0	150.0	st13
Laundry	c 1131	67	71	0.116	6.0	0x0	ShMt	38.0	140.0	st15
M Bath	h 3275	121	94	0.130	8.0	0x0	ShMt	19.5	140.0	st4
Pwd	h 398	15	7	0.121	4.0	0x0	ShMt	30.6	140.0	st16

Supply Trunk Detail Table

Name	Trunk Type	Htg (cfm)	Clg (cfm)	Design FR	Veloc (fpm)	Diam (in)	H x W (in)	Duct Material	Trunk
st5	Peak AVF	41	19	0.139	470	4.0	0 x 0	ShtMetl	st4
st4	Peak AVF	162	114	0.130	465	8.0	0 x 0	ShtMetl	st3
st2	Peak AVF	816	871	0.102	815	14.0	0 x 0	ShtMetl	
st10	Peak AVF	421	445	0.102	567	12.0	0 x 0	ShtMetl	st9
st9	Peak AVF	522	558	0.102	711	12.0	0 x 0	ShtMetl	st8
st13	Peak AVF	176	192	0.105	551	8.0	0 x 0	ShtMetl	st12
st16	Peak AVF	15	7	0.121	169	4.0	0 x 0	ShtMetl	st15
st15	Peak AVF	82	77	0.116	416	6.0	0 x 0	ShtMetl	st13
st3	Peak AVF	283	199	0.122	518	10.0	0 x 0	ShtMetl	st1
st1	Peak AVF	384	329	0.122	704	10.0	0 x 0	ShtMetl	
st12	Peak AVF	287	329	0.102	603	10.0	0 x 0	ShtMetl	st10
st8	Peak AVF	611	672	0.102	856	12.0	0 x 0	ShtMetl	st2

Return Branch Detail Table

Name	Grill Size (in)	Htg (cfm)	Clg (cfm)	TEL (ft)	Design FR	Veloc (fpm)	Diam (in)	H x W (in)	Stud/Joist Opening (in)	Duct Matl	Trunk
rb1	0x0	1200	1200	239.0	0.102	675	14.7	16x 16		ShMt	



1ST FLOOR

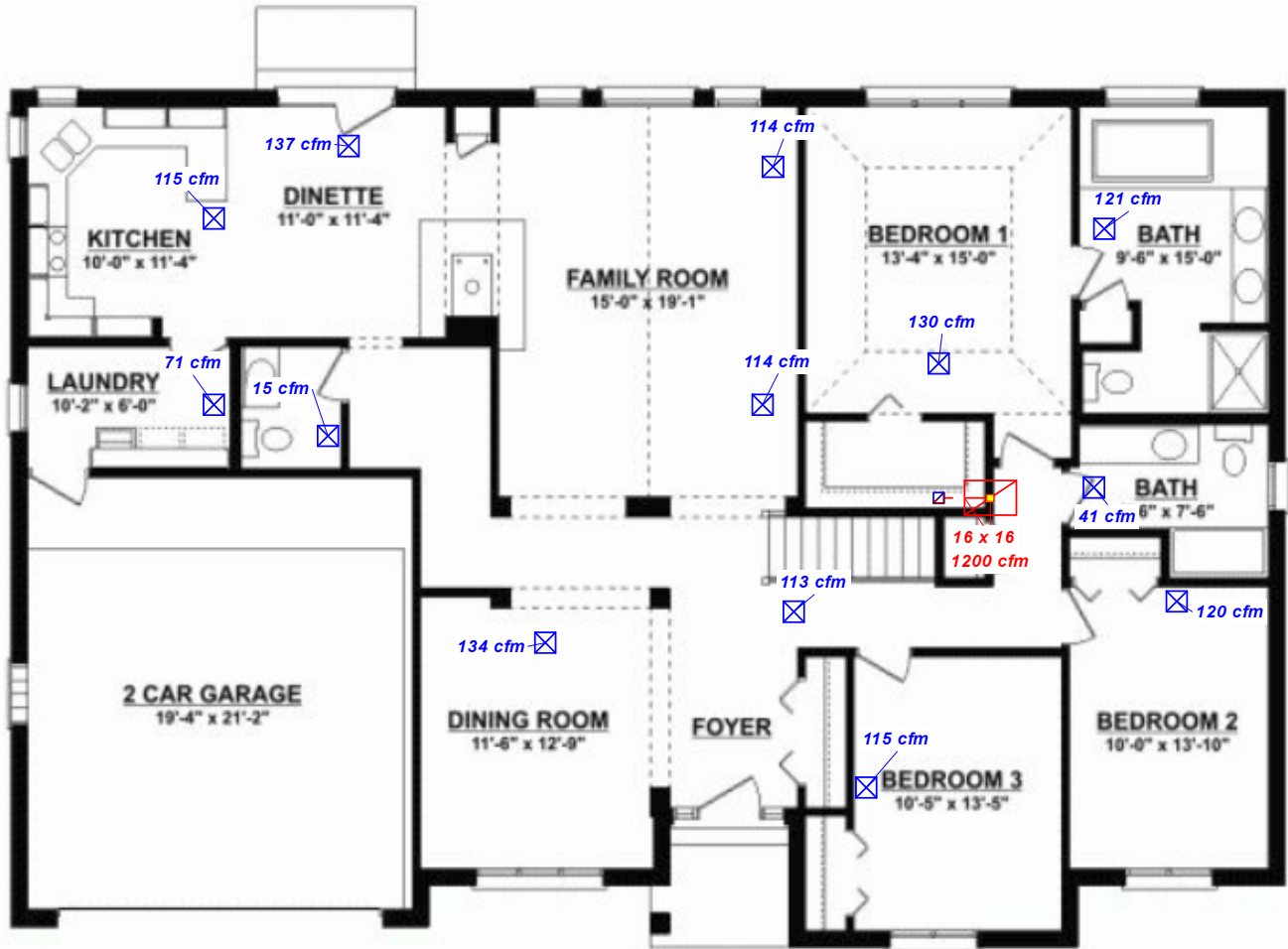

Job #:
Performed by ME for:
AHRI Project No. 8002
on the Life Cycle of Residential HVAC Systems
Home #1, Round Metal Duct

Austin Air Conditioning, Inc.
13620 Immanuel Rd
Pflugerville, TX 78660
Phone: 512-252-7711 Fax: 512-252-7744
www.austinaircond.com info@austinairconditioning.com

Scale: 1 : 111
Page 1
Right-Suite® Universal 2012
12.1.08 RSU15282
2013-Aug-05 13:14:42
...Home #1 Metal 2 (.45-.80 SP).rup



Project Summary
Entire House
 Austin Air Conditioning, Inc.

Job:
 Date: 7/31/13
 By: ME

13620 Immanuel Rd., Pflugerville, TX 78660 Phone: 512-252-7711 Fax: 512-252-7744 Email: info@austinairconditioning.com Web: www.austinaircond.com License: TACLB2314...

Project Information

For: AHRI Project No. 8002, The Impact of Duct Design on the Life Cycle of Residential HVAC Systems, Home #1, Round Metal Duct

Notes: R-21 WALLS, R-38 ATTIC, R-30 FLOOR OVER BASEMENT, .55 U-VALUE, .35 SHGC WINDOWS, FRONT DOOR FACES EAST

Design Information

Weather: Chicago Midway AP, IL, US

Winter Design Conditions

Outside db 4 °F
 Inside db 70 °F
 Design TD 66 °F

Summer Design Conditions

Outside db 92 °F
 Inside db 75 °F
 Design TD 17 °F
 Daily range L
 Relative humidity 50 %
 Moisture difference 40 gr/lb

Heating Summary

Structure 31001 Btuh
 Ducts 1425 Btuh
 Central vent (0 cfm) 0 Btuh
 Humidification 0 Btuh
 Piping 0 Btuh
 Equipment load 32426 Btuh

Sensible Cooling Equipment Load Sizing

Structure 18715 Btuh
 Ducts 503 Btuh
 Central vent (0 cfm) 0 Btuh
 Blower 0 Btuh
 Use manufacturer's data y
 Rate/swing multiplier 1.00
 Equipment sensible load 19218 Btuh

Infiltration

Method Simplified
 Construction quality Average
 Fireplaces 0

	Heating	Cooling
Area (ft ²)	1918	1918
Volume (ft ³)	18101	18101
Air changes/hour	0.38	0.20
Equiv. AVF (cfm)	115	60

Latent Cooling Equipment Load Sizing

Structure 2797 Btuh
 Ducts 647 Btuh
 Central vent (0 cfm) 0 Btuh
 Equipment latent load 3443 Btuh
 Equipment total load 22661 Btuh
 Req. total capacity at 0.78 SHR 2.1 ton

Heating Equipment Summary

Make Generic
 Trade
 Model 96% AFUE FURNACE
 AHRI ref

Efficiency	96 AFUE
Heating input	42790 MBtuh
Heating output	68000 Btuh
Temperature rise	53 °F
Actual air flow	1200 cfm
Air flow factor	0.037 cfm/Btuh
Static pressure	1.10 in H2O
Space thermostat	

Cooling Equipment Summary

Make GENERIC
 Trade
 Cond 3.0 TON AC
 Coil
 AHRI ref
 Efficiency 12.5 EER, 16 SEER

Sensible cooling	28000 Btuh
Latent cooling	8000 Btuh
Total cooling	36000 Btuh
Actual air flow	1200 cfm
Air flow factor	0.062 cfm/Btuh
Static pressure	1.10 in H2O
Load sensible heat ratio	0.85

Calculations approved by ACCA to meet all requirements of Manual J 8th Ed.



Duct System Summary

Entire House

Austin Air Conditioning, Inc.

Job:
Date: 7/31/13
By: ME

13620 Immanuel Rd, Pflugerville, TX 78660 Phone: 512-252-7711 Fax: 512-252-7744 Email: info@austinairconditioning.com Web: www.austinaircond.com License: TACL2314...

Project Information

For: AHRI Project No. 8002, The Impact of Duct Design
on the Life Cycle of Residential HVAC Systems, Home #1, Round Metal Duct

	Heating	Cooling
External static pressure	1.10 in H2O	1.10 in H2O
Pressure losses	0.35 in H2O	0.35 in H2O
Available static pressure	0.75 in H2O	0.75 in H2O
Supply / return available pressure	0.35 / 0.40 in H2O	0.35 / 0.40 in H2O
Lowest friction rate	0.169 in/100ft	0.169 in/100ft
Actual air flow	1200 cfm	1200 cfm
Total effective length (TEL)	443 ft	

Supply Branch Detail Table

Name	Design (Btuh)	Htg (cfm)	Clg (cfm)	Design FR	Diam (in)	H x W (in)	Duct Matl	Actual Ln (ft)	Ftg.Eqv Ln (ft)	Trunk
Bath	h 1108	41	19	0.231	4.0	0x0	ShMt	9.3	140.0	st5
Bed 1	c 2081	102	130	0.244	8.0	0x0	ShMt	6.8	135.0	st1
Bed 2	h 3253	120	85	0.203	8.0	0x0	ShMt	20.0	150.0	st3
Bed 3	h 3114	115	85	0.202	8.0	0x0	ShMt	21.0	150.0	st2
Dinette	c 2189	112	137	0.169	8.0	0x0	ShMt	44.0	160.0	st12
Dining	h 3613	134	116	0.178	8.0	0x0	ShMt	29.5	165.0	st10
Family	c 1828	89	114	0.175	8.0	0x0	ShMt	22.5	175.0	st2
Family-A	c 1828	89	114	0.214	8.0	0x0	ShMt	11.5	150.0	st8
Foyer	c 1812	101	113	0.173	8.0	0x0	ShMt	25.0	175.0	st9
Kitchen	c 1838	94	115	0.175	8.0	0x0	ShMt	47.0	150.0	st13
Laundry	c 1131	67	71	0.194	6.0	0x0	ShMt	38.0	140.0	st15
M Bath	h 3275	121	94	0.217	8.0	0x0	ShMt	19.5	140.0	st4
Pwd	h 398	15	7	0.202	4.0	0x0	ShMt	30.6	140.0	st16

Supply Trunk Detail Table

Name	Trunk Type	Htg (cfm)	Clg (cfm)	Design FR	Veloc (fpm)	Diam (in)	H x W (in)	Duct Material	Trunk
st5	Peak AVF	41	19	0.231	470	4.0	0 x 0	ShtMetl	st4
st4	Peak AVF	162	114	0.217	826	6.0	0 x 0	ShtMetl	st3
st2	Peak AVF	816	871	0.169	815	14.0	0 x 0	ShtMetl	
st10	Peak AVF	421	445	0.169	816	10.0	0 x 0	ShtMetl	st9
st9	Peak AVF	522	558	0.169	711	12.0	0 x 0	ShtMetl	st8
st13	Peak AVF	176	192	0.175	551	8.0	0 x 0	ShtMetl	st12
st16	Peak AVF	15	7	0.202	169	4.0	0 x 0	ShtMetl	st15
st15	Peak AVF	82	77	0.194	416	6.0	0 x 0	ShtMetl	st13
st3	Peak AVF	283	199	0.203	809	8.0	0 x 0	ShtMetl	st1
st1	Peak AVF	384	329	0.203	704	10.0	0 x 0	ShtMetl	
st12	Peak AVF	287	329	0.169	603	10.0	0 x 0	ShtMetl	st10
st8	Peak AVF	611	672	0.169	856	12.0	0 x 0	ShtMetl	st2

Return Branch Detail Table

Name	Grill Size (in)	Htg (cfm)	Clg (cfm)	TEL (ft)	Design FR	Veloc (fpm)	Diam (in)	H x W (in)	Stud/Joist Opening (in)	Duct Matl	Trunk
rb1	0x0	1200	1200	239.0	0.169	675	13.3	16x 16		ShMt	



1ST FLOOR

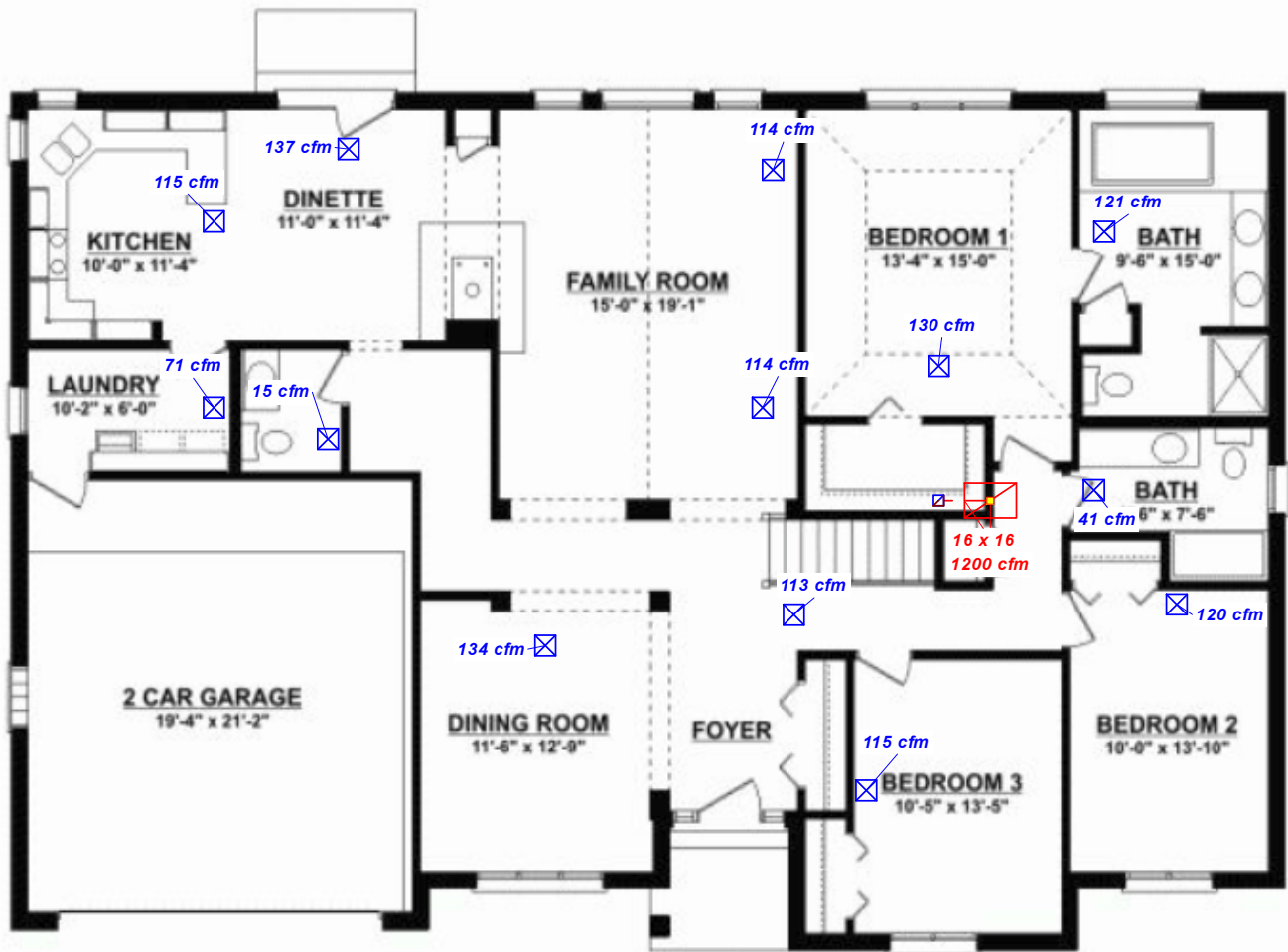

Job #:
Performed by ME for:
AHRI Project No. 8002
on the Life Cycle of Residential HVAC Systems
Home #1, Round Metal Duct

Austin Air Conditioning, Inc.
13620 Immanuel Rd
Pflugerville, TX 78660
Phone: 512-252-7711 Fax: 512-252-7744
www.austinaircond.com info@austinairconditioning.com

Scale: 1 : 111
Page 1
Right-Suite® Universal 2012
12.1.08 RSU15282
2013-Aug-05 13:18:26
...ome #1 Metal 3 (.75-1.10 SP).rup



Basement

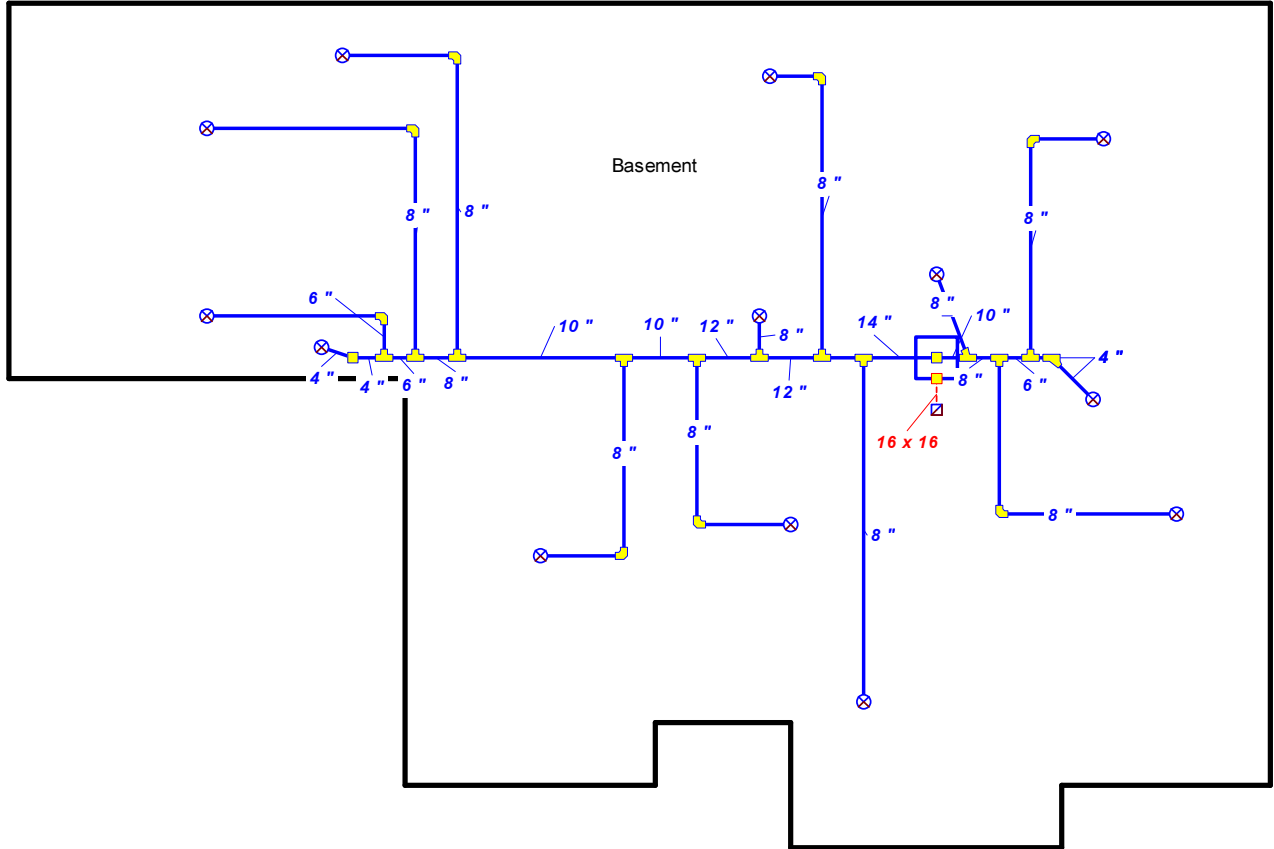

Job #:
Performed by ME for:
AHRI Project No. 8002
on the Life Cycle of Residential HVAC Systems
Home #1, Round Metal Duct

Austin Air Conditioning, Inc.
13620 Immanuel Rd
Pflugerville, TX 78660
Phone: 512-252-7711 Fax: 512-252-7744
www.austinaircond.com info@austinairconditioning.com

Scale: 1 : 111
Page 2
Right-Suite© Universal 2012
12.1.08 RSU15282
2013-Aug-05 13:18:27
...ome #1 Metal 3 (.75-1.10 SP).rup



13620 Immanuel Rd. • Pflugerville, Texas 78660 • (512)252-7711 • Fax (512) 252-7744

TACLB23145E

Illinois Institute of Technology

November 26, 2013

AHRI Project No. 8002

House #2

.20 Available / .55 External Static Pressures

Design Conditions:

R19 walls / R38 vented attic, R30 exposed floor over basement, .36 U-Value .30 SHGC Low E glass windows, window coverings where applicable, and front door facing Southeast

Design Temperatures: Austin/Bergstrom, TX - Summer ODB 99 / IDB 75 degrees, Winter ODB 30 / IDB 70 degrees

Price Includes:

One Lennox 14 SEER 4.0 Ton heat pump with Lennox horizontal air handler and electric auxiliary heat strips, (1) Honeywell Focus Pro 6000 programmable thermostats, **R8 Fiberglass & R8 insulated flex duct in attic OR R8 wrapped metal duct**, Airmate stamped metal registers, disposable 1” MERV8 filters, running of copper, drain, and low-voltage control wire, system start-up & our standard one-year limited warranty.

HOUSE #1	FLEX DUCT	METAL DUCT
Equipment, Copper, Drains & Wiring	\$ 2,090.12	\$ 2,090.12
Supply Air Materials	\$ 999.78	\$ 1,617.42
Return Air Materials	\$ 353.68	\$ 600.48
In-House & Contractor Labor	\$ 965.00	\$ 2,186
Tax, Overhead & Profit	\$ 1,863.79	\$ 2,920
Estimated Total Installation Cost	\$ 6,272	\$9,414

Notes:

- 1) These quoted prices do not reflect installation of jumper duct returns, range, dryer or exhaust fan venting typically included in our estimates.
- 2) Chart shows raw costs untaxed and with no profit markup.
- 3) Supply & Return Air Materials includes items such as mastic, foil tape, boots, grilles, filters, straps and struts.

Exclusions:

Electrical, plumbing, carpentry, connecting drain lines, building catwalks and platforms, jumper ducts, range venting, dryer venting, exhaust fans or venting, IAO products, permitting, hanging the stove hood, make-up air if required, third-party testing or inspection fees, third-party rating program requirements, or sealing supply and return registers to the sheetrock.

Warranty:

Price includes standard limited warranty of one year on the entire installation, with an additional nine years on parts **when registered at www.lennoxregistration.com by homeowner** or four years when not registered. This does not include routine maintenance performed by the property owner or any other limitation as noted on the equipment manufacturer’s limited warranty certificate.



13620 Immanuel Rd. • Pflugerville, Texas 78660 • (512)252-7711 • Fax (512) 252-7744

TACLB23145E

Illinois Institute of Technology

November 26, 2013

AHRI Project No. 8002

House #2

.50 Available / .85 External Static Pressures

Design Conditions:

R19 walls / R38 vented attic, R30 exposed floor over basement, .36 U-Value .30 SHGC Low E glass windows, window coverings where applicable, and front door facing Southeast

Design Temperatures: Austin/Bergstrom, TX - Summer ODB 99 / IDB 75 degrees, Winter ODB 30 / IDB 70 degrees

Price Includes:

One Lennox 14 SEER 4.0 Ton heat pump with Lennox horizontal air handler and electric auxiliary heat strips, (1) Honeywell Focus Pro 6000 programmable thermostats, **R8 Fiberglass & R8 insulated flex duct in attic OR R8 wrapped metal duct**, Airmate stamped metal registers, disposable 1” MERV8 filters, running of copper, drain, and low-voltage control wire, system start-up & our standard one-year limited warranty.

HOUSE #1	FLEX DUCT	METAL DUCT
Equipment, Copper, Drains & Wiring	\$ 2,090.12	\$ 2,090.12
Supply Air Materials	\$ 984.41	\$ 1,502.26
Return Air Materials	\$ 353.68	\$ 600.48
In-House & Contractor Labor	\$ 965.00	\$ 2,192.00
Tax, Overhead & Profit	\$ 1,856.90	\$ 2,864.68
Estimated Total Installation Cost	\$ 6,250	\$9,250

Notes:

- 1) These quoted prices do not reflect installation of jumper duct returns, range, dryer or exhaust fan venting typically included in our estimates.
- 2) Chart shows raw costs untaxed and with no profit markup.
- 3) Supply & Return Air Materials includes items such as mastic, foil tape, boots, grilles, filters, straps and struts.

Exclusions:

Electrical, plumbing, carpentry, connecting drain lines, building catwalks and platforms, jumper ducts, range venting, dryer venting, exhaust fans or venting, IAO products, permitting, hanging the stove hood, make-up air if required, third-party testing or inspection fees, third-party rating program requirements, or sealing supply and return registers to the sheetrock.

Warranty:

Price includes standard limited warranty of one year on the entire installation, with an additional nine years on parts **when registered at www.lennoxregistration.com by homeowner** or four years when not registered. This does not include routine maintenance performed by the property owner or any other limitation as noted on the equipment manufacturer’s limited warranty certificate.



13620 Immanuel Rd. • Pflugerville, Texas 78660 • (512)252-7711 • Fax (512) 252-7744

TACLB23145E

Illinois Institute of Technology
AHRI Project No. 8002
House #2
.80 Available / 1.15 External Static Pressures

November 26, 2013

Design Conditions:

R19 walls / R38 vented attic, R30 exposed floor over basement, .36 U-Value .30 SHGC Low E glass windows, window coverings where applicable, and front door facing Southeast

Design Temperatures: Austin/Bergstrom, TX - Summer ODB 99 / IDB 75 degrees, Winter ODB 30 / IDB 70 degrees

Price Includes:

One Lennox 14 SEER 4.0 Ton heat pump with Lennox horizontal air handler and electric auxiliary heat strips, (1) Honeywell Focus Pro 6000 programmable thermostats, **R8 Fiberglass & R8 insulated flex duct in attic OR R8 wrapped metal duct**, Airmate stamped metal registers, disposable 1” MERV8 filters, running of copper, drain, and low-voltage control wire, system start-up & our standard one-year limited warranty.

HOUSE #1	FLEX DUCT	METAL DUCT
Equipment, Copper, Drains & Wiring	\$ 2,090.12	\$ 2,090.12
Supply Air Materials	\$ 952.61	\$ 1,483.71
Return Air Materials	\$ 353.68	\$ 600.48
In-House & Contractor Labor	\$ 965.00	\$ 2,192
Tax, Overhead & Profit	\$ 1,842.65	\$ 2,855.44
Estimated Total Installation Cost	\$ 6,204	\$9,222

Notes:

- 1) These quoted prices do not reflect installation of jumper duct returns, range, dryer or exhaust fan venting typically included in our estimates.
- 2) Chart shows raw costs untaxed and with no profit markup.
- 3) Supply & Return Air Materials includes items such as mastic, foil tape, boots, grilles, filters, straps and struts.

Exclusions:

Electrical, plumbing, carpentry, connecting drain lines, building catwalks and platforms, jumper ducts, range venting, dryer venting, exhaust fans or venting, IAO products, permitting, hanging the stove hood, make-up air if required, third-party testing or inspection fees, third-party rating program requirements, or sealing supply and return registers to the sheetrock.

Warranty:

Price includes standard limited warranty of one year on the entire installation, with an additional nine years on parts **when registered at www.lennoxregistration.com by homeowner** or four years when not registered. This does not include routine maintenance performed by the property owner or any other limitation as noted on the equipment manufacturer’s limited warranty certificate.



Project Summary
Entire House
 Austin Air Conditioning, Inc.

Job: 3154 Sq.Ft.
 Date: 7/29/13
 By: MariaE.

13620 Immanuel Road, Pflugerville, TX 78660 Phone: 512-252-7711 Fax: 512-252-7744 Email: maria@austinairconditioning.com Web: www.austinairconditioning.com License: ...

Project Information

For: AHRI Project No.8002, The Impact of Duct Design on the Life Cycle of Residential HVAC Systems, Home #2, Flex Duct

Notes: Typical Single Story in a Southern Climate
 R-19 WALLS, R-38 CEILINGS, SLAB ON GRADE, .34-.36 U-VALUE .28-.30 SHGC
 WINDOWS, MED DRAPES 50%, FRONT DOOR FACES SOUTHEAST

Design Information

Weather: Austin/Bergstrom, TX, US

Winter Design Conditions

Outside db 30 °F
 Inside db 70 °F
 Design TD 40 °F

Summer Design Conditions

Outside db **99** °F
 Inside db 75 °F
 Design TD 24 °F
 Daily range M
 Relative humidity 50 %
 Moisture difference 29 gr/lb

Heating Summary

Structure 33467 Btuh
 Ducts 4788 Btuh
 Central vent (142 cfm) 6202 Btuh
 Humidification 0 Btuh
 Piping 0 Btuh
 Equipment load 44458 Btuh

Sensible Cooling Equipment Load Sizing

Structure 25861 Btuh
 Ducts 5310 Btuh
 Central vent (142 cfm) 3685 Btuh
 Blower 0 Btuh
 Use manufacturer's data y
 Rate/swing multiplier 1.00
 Equipment sensible load 34855 Btuh

Infiltration

Method Simplified
 Construction quality Tight
 Fireplaces 1 (Average)

	Heating	Cooling
Area (ft ²)	3163	3163
Volume (ft ³)	32019	32019
Air changes/hour	0.17	0.07
Equiv. AVF (cfm)	89	37

Latent Cooling Equipment Load Sizing

Structure 1520 Btuh
 Ducts 443 Btuh
 Central vent (142 cfm) 2740 Btuh
 Equipment latent load 4703 Btuh
 Equipment total load 39557 Btuh
 Req. total capacity at 0.78 SHR 3.7 ton

Heating Equipment Summary

Make GENERIC
 Trade 4.0 TON HEAT PUMP
 Model
 AHRI ref

Efficiency 8.4 HSPF
 Heating input
 Heating output 0 Btuh @ 47°F
 Temperature rise 0 °F
 Actual air flow 1600 cfm
 Air flow factor 0.042 cfm/Btuh
 Static pressure 0.55 in H2O
 Space thermostat

Cooling Equipment Summary

Make GENERIC
 Trade 4.0 TON HEAT PUMP
 Cond
 Coil
 AHRI ref
 Efficiency 12.5 EER, 15 SEER
 Sensible cooling 37440 Btuh
 Latent cooling 10560 Btuh
 Total cooling 48000 Btuh
 Actual air flow 1600 cfm
 Air flow factor 0.051 cfm/Btuh
 Static pressure 0.55 in H2O
 Load sensible heat ratio 0.88

Bold/italic values have been manually overridden

Calculations approved by ACCA to meet all requirements of Manual J 8th Ed.





Duct System Summary

Entire House

Austin Air Conditioning, Inc.

Job: 3154 Sq.Ft.
 Date: 7/29/13
 By: MariaE.

13620 Immanuel Road, Pflugerville, TX 78660 Phone: 512-252-7711 Fax: 512-252-7744 Email: maria@austinairconditioning.com Web: www.austinairconditioning.com License: ...

Project Information

For: AHRI Project No.8002, The Impact of Duct Design
 on the Life Cycle of Residential HVAC Systems, Home #2, Flex Duct

	Heating	Cooling
External static pressure	0.55 in H2O	0.55 in H2O
Pressure losses	0.35 in H2O	0.35 in H2O
Available static pressure	0.20 in H2O	0.20 in H2O
Supply / return available pressure	0.11 / 0.09 in H2O	0.11 / 0.09 in H2O
Lowest friction rate	0.068 in/100ft	0.068 in/100ft
Actual air flow	1600 cfm	1600 cfm
Total effective length (TEL)	295 ft	

Supply Branch Detail Table

Name	Design (Btuh)	Htg (cfm)	Clg (cfm)	Design FR	Diam (in)	H x W (in)	Duct Matl	Actual Ln (ft)	Ftg.Eqv Ln (ft)	Trunk
Bath 2	h 772	32	25	0.085	4.0	0x0	VIFx	18.3	110.0	st6
Bed 2	h 1797	75	61	0.090	5.0	0x0	VIFx	11.5	110.0	st1
Bed 3	h 4053	170	97	0.078	8.0	0x0	VIFx	29.8	110.0	st7
Breakfast	h 5335	223	215	0.076	10.0	0x0	VIFx	34.0	110.0	st5
Dining	c 594	25	31	0.126	4.0	0x0	VIFx	11.6	75.0	
Family	c 2976	100	153	0.070	8.0	0x0	VIFx	36.6	120.0	st4
Family-A	c 2976	100	153	0.068	8.0	0x0	VIFx	41.0	120.0	st4
Game/Teen Rm	c 2866	131	147	0.086	8.0	0x0	VIFx	17.7	110.0	st6
Her WIC	h 1307	55	26	0.068	5.0	0x0	VIFx	46.7	115.0	st2
Kitchen	c 2756	93	141	0.079	8.0	0x0	VIFx	29.5	110.0	st5
Lav 2	c 60	2	3	0.088	4.0	0x0	VIFx	14.4	110.0	st6
M Bath	h 2066	86	59	0.072	6.0	0x0	VIFx	37.3	115.0	st2
M Toilet	h 528	22	19	0.068	4.0	0x0	VIFx	45.8	115.0	st2
Master Bed	h 5196	217	200	0.090	9.0	0x0	VIFx	41.8	80.0	
Pwd	c 227	10	12	0.076	4.0	0x0	VIFx	29.6	115.0	st3
Study	c 3515	178	180	0.087	9.0	0x0	VIFx	16.3	110.0	st1
Utility	c 1047	17	54	0.078	4.0	0x0	VIFx	25.9	115.0	st3
WIC 3	h 1513	63	24	0.075	6.0	0x0	VIFx	36.2	110.0	st7

Bold/italic values have been manually overridden

Supply Trunk Detail Table

Name	Trunk Type	Htg (cfm)	Clg (cfm)	Design FR	Veloc (fpm)	Diam (in)	H x W (in)	Duct Material	Trunk
st1	Peak AVF	253	242	0.087	464	10.0	0 x 0	VinIFix	
st2	Peak AVF	163	104	0.068	467	8.0	0 x 0	VinIFix	
st3	Peak AVF	27	65	0.076	333	6.0	0 x 0	VinIFix	
st4	Peak AVF	201	306	0.068	560	10.0	0 x 0	VinIFix	
st5	Peak AVF	316	357	0.076	454	12.0	0 x 0	VinIFix	
st6	Peak AVF	165	175	0.085	396	9.0	0 x 0	VinIFix	
st7	Peak AVF	233	121	0.075	427	10.0	0 x 0	VinIFix	

Return Branch Detail Table

Name	Grill Size (in)	Htg (cfm)	Clg (cfm)	TEL (ft)	Design FR	Veloc (fpm)	Diam (in)	H x W (in)	Stud/Joist Opening (in)	Duct Matl	Trunk
rb2	0x0	782	929	133.7	0.068	526	18.0	0x 0		VIFx	
rb1	0x0	818	671	116.3	0.078	586	16.0	0x 0		VIFx	

Bold/italic values have been manually overridden

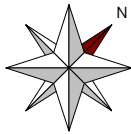

1ST FLOOR

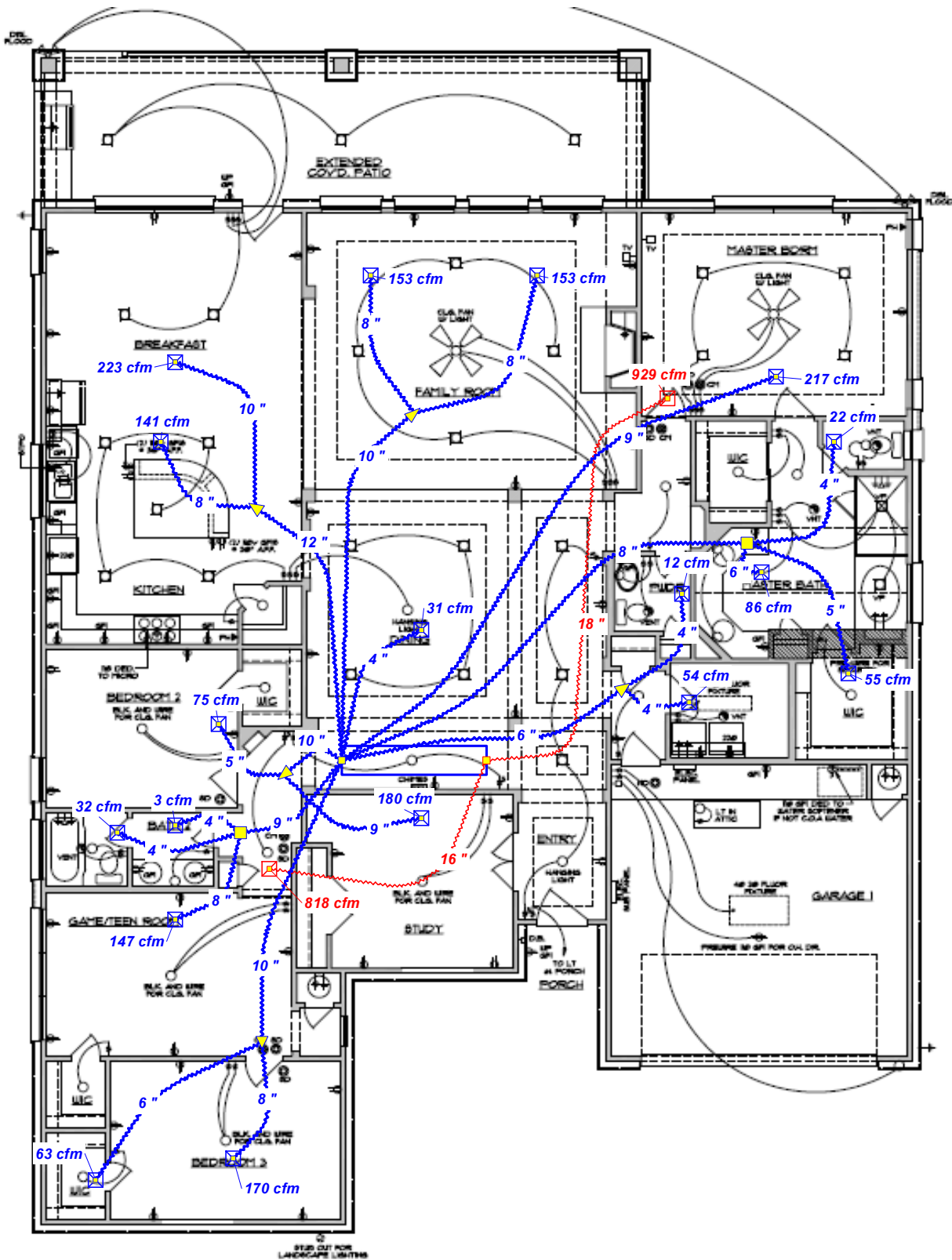

Job #: 3154 Sq.Ft.

Performed by Maria E. for:

AHRI Project No.8002
on the Life Cycle of Residential HVAC Systems
Home #2, Flex Duct

Austin Air Conditioning, Inc.

13620 Immanuel Road
Pflugerville, TX 78660
Phone: 512-252-7711 Fax: 512-252-7744
www.austinairconditioning.com maria@austinairconditio...

Scale: 1 : 125

Page 1
Right-Suite® Universal 2012
12.1.08 RSU15282
2013-Jul-31 09:59:29
...02\Home #2 Flex 1.20-.55 SP.rup



Project Summary
Entire House
 Austin Air Conditioning, Inc.

Job: 3154 Sq.Ft.
 Date: 7/29/13
 By: MariaE.

13620 Immanuel Road, Pflugerville, TX 78660 Phone: 512-252-7711 Fax: 512-252-7744 Email: maria@austinairconditioning.com Web: www.austinairconditioning.com License: ...

Project Information

For: AHRI Project No.8002, The Impact of Duct Design on the Life Cycle of Residential HVAC Systems, Home #2, Flex Duct

Notes: Typical Single Story in a Southern Climate
 R-19 WALLS, R-38 CEILINGS, SLAB ON GRADE, .34-.36 U-VALUE .28-.30 SHGC
 WINDOWS, MED DRAPES 50%, FRONT DOOR FACES SOUTHEAST

Design Information

Weather: Austin/Bergstrom, TX, US

Winter Design Conditions

Outside db 30 °F
 Inside db 70 °F
 Design TD 40 °F

Summer Design Conditions

Outside db 99 °F
 Inside db 75 °F
 Design TD 24 °F
 Daily range M
 Relative humidity 50 %
 Moisture difference 29 gr/lb

Heating Summary

Structure 33467 Btuh
 Ducts 4788 Btuh
 Central vent (142 cfm) 6202 Btuh
 Humidification 0 Btuh
 Piping 0 Btuh
 Equipment load 44458 Btuh

Sensible Cooling Equipment Load Sizing

Structure 25861 Btuh
 Ducts 5310 Btuh
 Central vent (142 cfm) 3685 Btuh
 Blower 0 Btuh
 Use manufacturer's data y
 Rate/swing multiplier 1.00
 Equipment sensible load 34855 Btuh

Infiltration

Method Simplified
 Construction quality Tight
 Fireplaces 1 (Average)

	Heating	Cooling
Area (ft ²)	3163	3163
Volume (ft ³)	32019	32019
Air changes/hour	0.17	0.07
Equiv. AVF (cfm)	89	37

Latent Cooling Equipment Load Sizing

Structure 1520 Btuh
 Ducts 443 Btuh
 Central vent (142 cfm) 2740 Btuh
 Equipment latent load 4703 Btuh
 Equipment total load 39557 Btuh
 Req. total capacity at 0.78 SHR 3.7 ton

Heating Equipment Summary

Make GENERIC
 Trade 4.0 TON HEAT PUMP
 Model
 AHRI ref

Efficiency 8.4 HSPF
 Heating input
 Heating output 0 Btuh @ 47°F
 Temperature rise 0 °F
 Actual air flow 1600 cfm
 Air flow factor 0.042 cfm/Btuh
 Static pressure 0.85 in H2O
 Space thermostat

Cooling Equipment Summary

Make GENERIC
 Trade 4.0 TON HEAT PUMP
 Cond
 Coil
 AHRI ref
 Efficiency 12.5 EER, 15 SEER
 Sensible cooling 37440 Btuh
 Latent cooling 10560 Btuh
 Total cooling 48000 Btuh
 Actual air flow 1600 cfm
 Air flow factor 0.051 cfm/Btuh
 Static pressure 0.85 in H2O
 Load sensible heat ratio 0.88

Calculations approved by ACCA to meet all requirements of Manual J 8th Ed.



Duct System Summary

Entire House

Austin Air Conditioning, Inc.

Job: 3154 Sq.Ft.
 Date: 7/29/13
 By: MariaE.

13620 Immanuel Road, Pflugerville, TX 78660 Phone: 512-252-7711 Fax: 512-252-7744 Email: maria@austinairconditioning.com Web: www.austinairconditioning.com License: ...

Project Information

For: AHRI Project No.8002, The Impact of Duct Design
 on the Life Cycle of Residential HVAC Systems, Home #2, Flex Duct

	Heating	Cooling
External static pressure	0.85 in H2O	0.85 in H2O
Pressure losses	0.35 in H2O	0.35 in H2O
Available static pressure	0.50 in H2O	0.50 in H2O
Supply / return available pressure	0.28 / 0.22 in H2O	0.28 / 0.22 in H2O
Lowest friction rate	0.163 in/100ft	0.163 in/100ft
Actual air flow	1600 cfm	1600 cfm
Total effective length (TEL)	308 ft	

Supply Branch Detail Table

Name	Design (Btuh)	Htg (cfm)	Clg (cfm)	Design FR	Diam (in)	H x W (in)	Duct Matl	Actual Ln (ft)	Ftg.Eqv Ln (ft)	Trunk
Bath 2	h 772	32	25	0.205	4.0	0x0	VIFx	18.3	120.0	st6
Bed 2	h 1797	75	61	0.233	5.0	0x0	VIFx	11.5	110.0	st1
Bed 3	h 4053	170	97	0.189	8.0	0x0	VIFx	29.8	120.0	st7
Breakfast	h 5335	223	215	0.163	9.0	0x0	VIFx	34.0	140.0	st5
Dining	c 594	25	31	0.326	4.0	0x0	VIFx	11.6	75.0	
Family	c 2976	100	153	0.181	8.0	0x0	VIFx	36.6	120.0	st4
Family-A	c 2976	100	153	0.176	8.0	0x0	VIFx	41.0	120.0	st4
Game/Teen Rm	c 2866	131	147	0.205	7.0	0x0	VIFx	17.7	120.0	st6
Her WIC	h 1307	55	26	0.175	5.0	0x0	VIFx	46.7	115.0	st2
Kitchen	c 2756	93	141	0.167	7.0	0x0	VIFx	29.5	140.0	st5
Lav 2	c 60	2	3	0.210	4.0	0x0	VIFx	14.4	120.0	st6
M Bath	h 2066	86	59	0.186	6.0	0x0	VIFx	37.3	115.0	st2
M Toilet	h 528	22	19	0.176	4.0	0x0	VIFx	45.8	115.0	st2
Master Bed	h 5196	217	200	0.232	9.0	0x0	VIFx	41.8	80.0	
Pwd	c 227	10	12	0.196	4.0	0x0	VIFx	29.6	115.0	st3
Study	c 3515	178	180	0.224	8.0	0x0	VIFx	16.3	110.0	st1
Utility	c 1047	17	54	0.201	4.0	0x0	VIFx	25.9	115.0	st3
WIC 3	h 1513	63	24	0.181	5.0	0x0	VIFx	36.2	120.0	st7

Supply Trunk Detail Table

Name	Trunk Type	Htg (cfm)	Clg (cfm)	Design FR	Veloc (fpm)	Diam (in)	H x W (in)	Duct Material	Trunk
st1	Peak AVF	253	242	0.224	573	9.0	0 x 0	VinlFix	
st2	Peak AVF	163	104	0.175	467	8.0	0 x 0	VinlFix	
st3	Peak AVF	27	65	0.196	479	5.0	0 x 0	VinlFix	
st4	Peak AVF	201	306	0.176	560	10.0	0 x 0	VinlFix	
st5	Peak AVF	316	357	0.163	654	10.0	0 x 0	VinlFix	
st6	Peak AVF	165	175	0.205	502	8.0	0 x 0	VinlFix	
st7	Peak AVF	233	121	0.181	527	9.0	0 x 0	VinlFix	

Return Branch Detail Table

Name	Grill Size (in)	Htg (cfm)	Clg (cfm)	TEL (ft)	Design FR	Veloc (fpm)	Diam (in)	H x W (in)	Stud/Joist Opening (in)	Duct Matl	Trunk
rb2	0x0	782	929	133.7	0.163	665	16.0	0x 0		VIFx	
rb1	0x0	818	671	116.3	0.187	586	16.0	0x 0		VIFx	

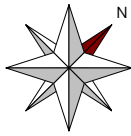

1ST FLOOR

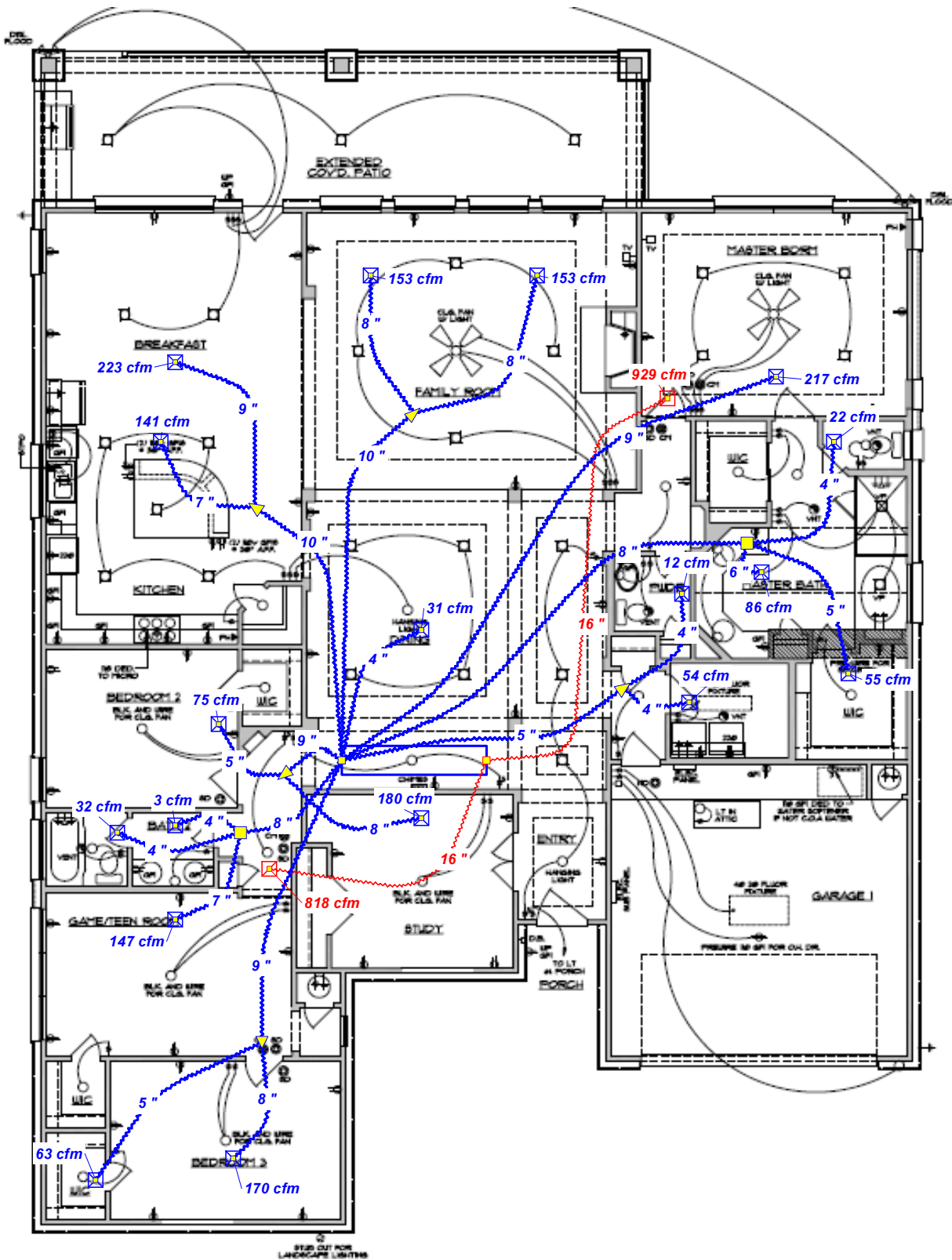

Job #: 3154 Sq.Ft.
Performed by Maria E. for:
 AHRI Project No.8002
 on the Life Cycle of Residential HVAC Systems
 Home #2, Flex Duct

Austin Air Conditioning, Inc.
 13620 Immanuel Road
 Pflugerville, TX 78660
 Phone: 512-252-7711 Fax: 512-252-7744
www.austinairconditioning.com maria@austinairconditio...

Scale: 1 : 125
 Page 1
 Right-Suite® Universal 2012
 12.1.08 RSU15282
 2013-Jul-31 10:00:53
 ...02\Home #2 Flex 2 .50-.85 SP.rup



Project Summary
Entire House
 Austin Air Conditioning, Inc.

Job: 3154 Sq.Ft.
 Date: 7/29/13
 By: MariaE.

13620 Immanuel Road, Pflugerville, TX 78660 Phone: 512-252-7711 Fax: 512-252-7744 Email: maria@austinairconditioning.com Web: www.austinairconditioning.com License: ...

Project Information

For: AHRI Project No.8002, The Impact of Duct Design on the Life Cycle of Residential HVAC Systems, Home #2, Flex Duct

Notes: Typical Single Story in a Southern Climate
 R-19 WALLS, R-38 CEILINGS, SLAB ON GRADE, .34-.36 U-VALUE .28-.30 SHGC
 WINDOWS, MED DRAPES 50%, FRONT DOOR FACES SOUTHEAST

Design Information

Weather: Austin/Bergstrom, TX, US

Winter Design Conditions

Outside db 30 °F
 Inside db 70 °F
 Design TD 40 °F

Summer Design Conditions

Outside db 99 °F
 Inside db 75 °F
 Design TD 24 °F
 Daily range M
 Relative humidity 50 %
 Moisture difference 29 gr/lb

Heating Summary

Structure 33467 Btuh
 Ducts 4788 Btuh
 Central vent (142 cfm) 6202 Btuh
 Humidification 0 Btuh
 Piping 0 Btuh
 Equipment load 44458 Btuh

Sensible Cooling Equipment Load Sizing

Structure 25861 Btuh
 Ducts 5310 Btuh
 Central vent (142 cfm) 3685 Btuh
 Blower 0 Btuh
 Use manufacturer's data y
 Rate/swing multiplier 1.00
 Equipment sensible load 34855 Btuh

Infiltration

Method Simplified
 Construction quality Tight
 Fireplaces 1 (Average)

	Heating	Cooling
Area (ft ²)	3163	3163
Volume (ft ³)	32019	32019
Air changes/hour	0.17	0.07
Equiv. AVF (cfm)	89	37

Latent Cooling Equipment Load Sizing

Structure 1520 Btuh
 Ducts 443 Btuh
 Central vent (142 cfm) 2740 Btuh
 Equipment latent load 4703 Btuh
 Equipment total load 39557 Btuh
 Req. total capacity at 0.78 SHR 3.7 ton

Heating Equipment Summary

Make GENERIC
 Trade 4.0 TON HEAT PUMP
 Model
 AHRI ref

Efficiency 8.4 HSPF
 Heating input
 Heating output 0 Btuh @ 47°F
 Temperature rise 0 °F
 Actual air flow 1600 cfm
 Air flow factor 0.042 cfm/Btuh
 Static pressure 1.15 in H2O
 Space thermostat

Cooling Equipment Summary

Make GENERIC
 Trade 4.0 TON HEAT PUMP
 Cond
 Coil
 AHRI ref
 Efficiency 12.5 EER, 15 SEER
 Sensible cooling 37440 Btuh
 Latent cooling 10560 Btuh
 Total cooling 48000 Btuh
 Actual air flow 1600 cfm
 Air flow factor 0.051 cfm/Btuh
 Static pressure 1.15 in H2O
 Load sensible heat ratio 0.88

Calculations approved by ACCA to meet all requirements of Manual J 8th Ed.





Duct System Summary

Entire House

Austin Air Conditioning, Inc.

Job: 3154 Sq.Ft.
 Date: 7/29/13
 By: MariaE.

13620 Immanuel Road, Pflugerville, TX 78660 Phone: 512-252-7711 Fax: 512-252-7744 Email: maria@austinairconditioning.com Web: www.austinairconditioning.com License: ...

Project Information

For: AHRI Project No.8002, The Impact of Duct Design
 on the Life Cycle of Residential HVAC Systems, Home #2, Flex Duct

	Heating	Cooling
External static pressure	1.15 in H2O	1.15 in H2O
Pressure losses	0.35 in H2O	0.35 in H2O
Available static pressure	0.80 in H2O	0.80 in H2O
Supply / return available pressure	0.47 / 0.33 in H2O	0.47 / 0.33 in H2O
Lowest friction rate	0.246 in/100ft	0.246 in/100ft
Actual air flow	1600 cfm	1600 cfm
Total effective length (TEL)	325 ft	

Supply Branch Detail Table

Name	Design (Btuh)	Htg (cfm)	Clg (cfm)	Design FR	Diam (in)	H x W (in)	Duct Matl	Actual Ln (ft)	Ftg.Eqv Ln (ft)	Trunk
Bath 2	h 772	32	25	0.298	4.0	0x0	VIFx	18.3	140.0	st6
Bed 2	h 1797	75	61	0.311	5.0	0x0	VIFx	11.5	140.0	st1
Bed 3	h 4053	170	97	0.315	7.0	0x0	VIFx	29.8	120.0	st7
Breakfast	h 5335	223	215	0.249	8.0	0x0	VIFx	34.0	155.0	st5
Dining	c 594	25	31	0.544	4.0	0x0	VIFx	11.6	75.0	
Family	c 2976	100	153	0.267	7.0	0x0	VIFx	36.6	140.0	st4
Family-A	c 2976	100	153	0.260	7.0	0x0	VIFx	41.0	140.0	st4
Game/Teen Rm	c 2866	131	147	0.299	7.0	0x0	VIFx	17.7	140.0	st6
Her WIC	h 1307	55	26	0.246	5.0	0x0	VIFx	46.7	145.0	st2
Kitchen	c 2756	93	141	0.256	7.0	0x0	VIFx	29.5	155.0	st5
Lav 2	c 60	2	3	0.305	4.0	0x0	VIFx	14.4	140.0	st6
M Bath	h 2066	86	59	0.259	6.0	0x0	VIFx	37.3	145.0	st2
M Toilet	h 528	22	19	0.247	4.0	0x0	VIFx	45.8	145.0	st2
Master Bed	h 5196	217	200	0.387	9.0	0x0	VIFx	41.8	80.0	
Pwd	c 227	10	12	0.326	4.0	0x0	VIFx	29.6	115.0	st3
Study	c 3515	178	180	0.302	7.0	0x0	VIFx	16.3	140.0	st1
Utility	c 1047	17	54	0.335	5.0	0x0	VIFx	25.9	115.0	st3
WIC 3	h 1513	63	24	0.302	5.0	0x0	VIFx	36.2	120.0	st7

Supply Trunk Detail Table

Name	Trunk Type	Htg (cfm)	Clg (cfm)	Design FR	Veloc (fpm)	Diam (in)	H x W (in)	Duct Material	Trunk
st1	Peak AVF	253	242	0.302	573	9.0	0 x 0	VinlFix	
st2	Peak AVF	163	104	0.246	467	8.0	0 x 0	VinlFix	
st3	Peak AVF	27	65	0.326	333	6.0	0 x 0	VinlFix	
st4	Peak AVF	201	306	0.260	692	9.0	0 x 0	VinlFix	
st5	Peak AVF	316	357	0.249	654	10.0	0 x 0	VinlFix	
st6	Peak AVF	165	175	0.298	502	8.0	0 x 0	VinlFix	
st7	Peak AVF	233	121	0.302	667	8.0	0 x 0	VinlFix	

Return Branch Detail Table

Name	Grill Size (in)	Htg (cfm)	Clg (cfm)	TEL (ft)	Design FR	Veloc (fpm)	Diam (in)	H x W (in)	Stud/Joist Opening (in)	Duct Matl	Trunk
rb2	0x0	782	929	133.7	0.246	665	16.0	0x 0		VIFx	
rb1	0x0	818	671	116.3	0.282	586	16.0	0x 0		VIFx	

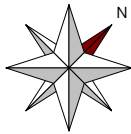

1ST FLOOR

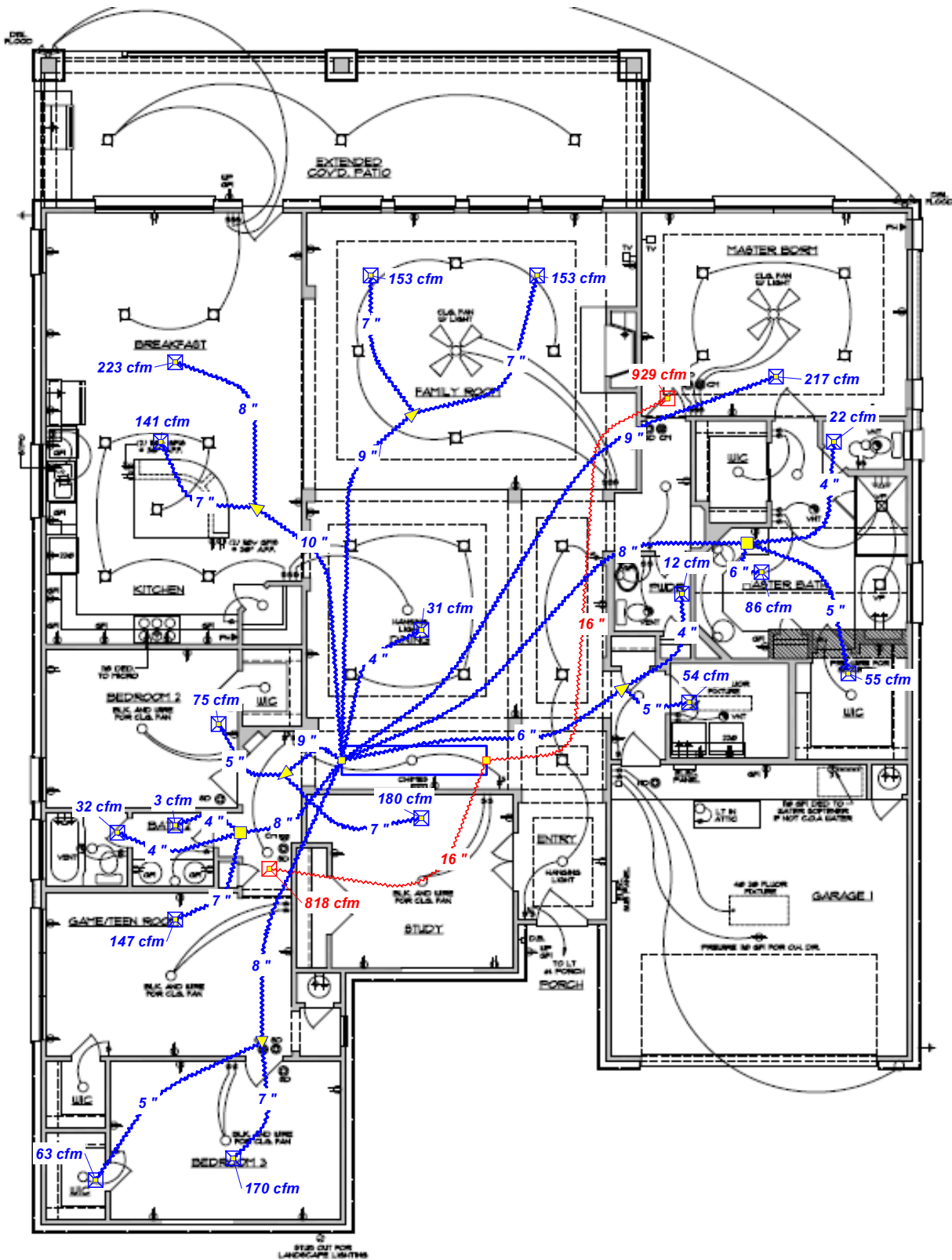

Job #: 3154 Sq.Ft.
Performed by Maria E. for:
 AHRI Project No.8002
 on the Life Cycle of Residential HVAC Systems
 Home #2, Flex Duct

Austin Air Conditioning, Inc.
 13620 Immanuel Road
 Pflugerville, TX 78660
 Phone: 512-252-7711 Fax: 512-252-7744
www.austinairconditioning.com maria@austinairconditio...

Scale: 1 : 125
 Page 1
 Right-Suite® Universal 2012
 12.1.08 RSU15282
 2013-Jul-31 10:08:21
 ...2\Home #2 Flex 2 .80-1.15 SP.rup



Project Summary
Entire House
 Austin Air Conditioning, Inc.

Job: 3154 Sq.Ft.
 Date: 7/29/13
 By: MariaE.

13620 Immanuel Road, Pflugerville, TX 78660 Phone: 512-252-7711 Fax: 512-252-7744 Email: maria@austinairconditioning.com Web: www.austinairconditioning.com License: ...

Project Information

For: AHRI Project No.8002, The Impact of Duct Design on the Life Cycle of Residential HVAC Systems, Home #2, Metal Square/Round Duct

Notes: Typical Single Story in a Southern Climate
 R-19 WALLS, R-38 CEILINGS, SLAB ON GRADE, .34-.36 U-VALUE .28-.30 SHGC
 WINDOWS, MED DRAPES 50%, FRONT DOOR FACES SOUTHEAST

Design Information

Weather: Austin/Bergstrom, TX, US

Winter Design Conditions

Outside db 30 °F
 Inside db 70 °F
 Design TD 40 °F

Summer Design Conditions

Outside db 99 °F
 Inside db 75 °F
 Design TD 24 °F
 Daily range M
 Relative humidity 50 %
 Moisture difference 29 gr/lb

Heating Summary

Structure 33467 Btuh
 Ducts 4788 Btuh
 Central vent (142 cfm) 6202 Btuh
 Humidification 0 Btuh
 Piping 0 Btuh
 Equipment load 44458 Btuh

Sensible Cooling Equipment Load Sizing

Structure 25861 Btuh
 Ducts 5310 Btuh
 Central vent (142 cfm) 3685 Btuh
 Blower 0 Btuh
 Use manufacturer's data y
 Rate/swing multiplier 1.00
 Equipment sensible load 34855 Btuh

Infiltration

Method Simplified
 Construction quality Tight
 Fireplaces 1 (Average)

	Heating	Cooling
Area (ft ²)	3163	3163
Volume (ft ³)	32019	32019
Air changes/hour	0.17	0.07
Equiv. AVF (cfm)	89	37

Latent Cooling Equipment Load Sizing

Structure 1520 Btuh
 Ducts 443 Btuh
 Central vent (142 cfm) 2740 Btuh
 Equipment latent load 4703 Btuh
 Equipment total load 39557 Btuh
 Req. total capacity at 0.78 SHR 3.7 ton

Heating Equipment Summary

Make GENERIC
 Trade 4.0 TON HEAT PUMP
 Model
 AHRI ref

Efficiency 8.4 HSPF
 Heating input
 Heating output 0 Btuh @ 47°F
 Temperature rise 0 °F
 Actual air flow 1600 cfm
 Air flow factor 0.042 cfm/Btuh
 Static pressure 0.55 in H2O
 Space thermostat

Cooling Equipment Summary

Make GENERIC
 Trade 4.0 TON HEAT PUMP
 Cond
 Coil
 AHRI ref
 Efficiency 12.5 EER, 15 SEER
 Sensible cooling 37440 Btuh
 Latent cooling 10560 Btuh
 Total cooling 48000 Btuh
 Actual air flow 1600 cfm
 Air flow factor 0.051 cfm/Btuh
 Static pressure 0.55 in H2O
 Load sensible heat ratio 0.88

Calculations approved by ACCA to meet all requirements of Manual J 8th Ed.





Duct System Summary

Entire House

Austin Air Conditioning, Inc.

Job: 3154 Sq.Ft.
 Date: 7/29/13
 By: MariaE.

13620 Immanuel Road, Pflugerville, TX 78660 Phone: 512-252-7711 Fax: 512-252-7744 Email: maria@austinairconditioning.com Web: www.austinairconditioning.com License: ...

Project Information

For: AHRI Project No.8002, The Impact of Duct Design
 on the Life Cycle of Residential HVAC Systems, Home #2, Metal Square/Round Duct

	Heating	Cooling
External static pressure	0.55 in H2O	0.55 in H2O
Pressure losses	0.35 in H2O	0.35 in H2O
Available static pressure	0.20 in H2O	0.20 in H2O
Supply / return available pressure	0.13 / 0.07 in H2O	0.13 / 0.07 in H2O
Lowest friction rate	0.045 in/100ft	0.045 in/100ft
Actual air flow	1600 cfm	1600 cfm
Total effective length (TEL)	447 ft	

Supply Branch Detail Table

Name	Design (Btuh)	Htg (cfm)	Clg (cfm)	Design FR	Diam (in)	H x W (in)	Duct Matl	Actual Ln (ft)	Ftg.Eqv Ln (ft)	Trunk
Bath 2	h 772	32	25	0.070	4.0	0x0	ShMt	40.0	150.0	st2A
Bed 2	h 1797	75	61	0.054	5.0	0x0	ShMt	29.5	215.0	st6
Bed 3	h 4053	170	97	0.046	8.0	0x0	ShMt	42.5	245.0	st5
Breakfast	h 5335	223	215	0.062	9.0	0x0	ShMt	52.6	160.0	st10
Dining	c 594	25	31	0.057	4.0	0x0	ShMt	19.5	215.0	st6
Family-A	c 2976	100	153	0.055	8.0	0x0	ShMt	37.4	205.0	st12
Family-B	c 2976	100	153	0.063	8.0	0x0	ShMt	30.9	180.0	st11
Game/Teen Rm	c 2866	131	147	0.051	8.0	0x0	ShMt	37.9	220.0	st4
Her WIC	h 1307	55	26	0.060	5.0	0x0	ShMt	44.4	175.0	st14
Kitchen	c 2756	93	141	0.062	8.0	0x0	ShMt	53.9	160.0	st10
Lav 2	c 60	2	3	0.050	4.0	0x0	ShMt	36.0	230.0	st2A
M Bath	h 2066	86	59	0.062	6.0	0x0	ShMt	37.2	175.0	st14
M Toilet	h 528	22	19	0.070	4.0	0x0	ShMt	38.2	150.0	st13
Master Bed	h 5196	217	200	0.055	9.0	0x0	ShMt	39.6	200.0	st8
Pwd	c 227	10	12	0.077	4.0	0x0	ShMt	21.0	150.0	st15
Study	c 3515	178	180	0.064	8.0	0x0	ShMt	17.5	190.0	st2
Utility	c 1047	17	54	0.077	4.0	0x0	ShMt	21.6	150.0	st15
WIC 3	h 1513	63	24	0.045	5.0	0x0	ShMt	51.4	245.0	st5

Supply Trunk Detail Table

Name	Trunk Type	Htg (cfm)	Clg (cfm)	Design FR	Veloc (fpm)	Diam (in)	H x W (in)	Duct Material	Trunk
st6	Peak AVF	1024	1124	0.054	723	16.3	14 x 16	ShtMetl	st1
st15	Peak AVF	27	65	0.077	479	5.0	0 x 0	ShtMetl	st6
st2A	Peak AVF	34	28	0.050	395	4.0	0 x 0	ShtMetl	st2
st2	Peak AVF	576	476	0.045	494	13.2	12 x 14	ShtMetl	st1
st3	Peak AVF	364	268	0.045	436	11.1	10 x 12	ShtMetl	st2
st4	Peak AVF	364	268	0.045	463	12.0	0 x 0	ShtMetl	st3
st5	Peak AVF	233	121	0.045	427	10.0	0 x 0	ShtMetl	st4
st10	Peak AVF	316	357	0.062	454	12.0	0 x 0	ShtMetl	st9
st7	Peak AVF	898	967	0.055	621	15.4	14 x 16	ShtMetl	st6
st8	Peak AVF	734	863	0.055	634	14.7	14 x 14	ShtMetl	st7
st13	Peak AVF	163	104	0.060	467	8.0	0 x 0	ShtMetl	st7
st14	Peak AVF	141	85	0.060	404	8.0	0 x 0	ShtMetl	st13
st9	Peak AVF	517	662	0.055	568	13.3	12 x 14	ShtMetl	st8
st11	Peak AVF	201	306	0.055	440	10.0	10 x 10	ShtMetl	st9
st12	Peak AVF	100	153	0.055	458	7.7	6 x 8	ShtMetl	st11
st1	Peak AVF	1600	1600	0.045	711	19.3	18 x 18	ShtMetl	

Return Branch Detail Table

Name	Grill Size (in)	Htg (cfm)	Clg (cfm)	TEL (ft)	Design FR	Veloc (fpm)	Diam (in)	H x W (in)	Stud/Joist Opening (in)	Duct Matl	Trunk
rb1	0x0	1600	1600	151.0	0.045	640	19.3	18x 20		ShMt	

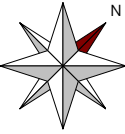

1ST FLOOR

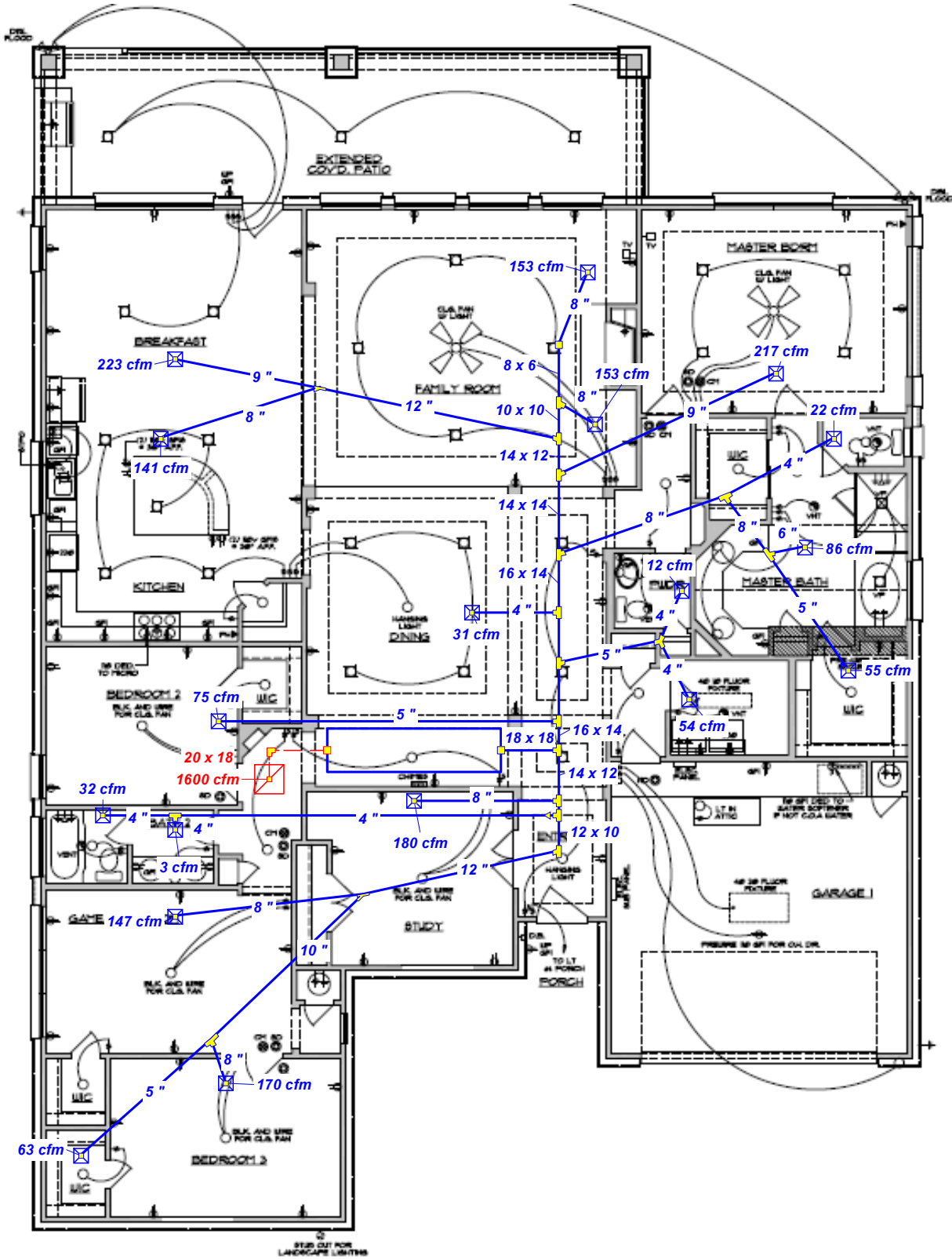

Job #: 3154 Sq.Ft.
Performed by Maria E. for:
 AHRI Project No.8002
 on the Life Cycle of Residential HVAC Systems
 Home #2, Metal Square/Round Duct

Austin Air Conditioning, Inc.
 13620 Immanuel Road
 Pflugerville, TX 78660
 Phone: 512-252-7711 Fax: 512-252-7744
www.austinairconditioning.com maria@austinairconditio...

Scale: 1 : 125
 Page 1
 Right-Suite® Universal 2012
 12.1.08 RSU15282
 2013-Jul-31 12:19:40
 ...2\Home #2 Metal 1.20-.55 SP.rup



Project Summary
Entire House
 Austin Air Conditioning, Inc.

Job: 3154 Sq.Ft.
 Date: 7/29/13
 By: MariaE.

13620 Immanuel Road, Pflugerville, TX 78660 Phone: 512-252-7711 Fax: 512-252-7744 Email: maria@austinairconditioning.com Web: www.austinairconditioning.com License: ...

Project Information

For: AHRI Project No.8002, The Impact of Duct Design on the Life Cycle of Residential HVAC Systems, Home #2, Metal Square/Round Duct

Notes: Typical Single Story in a Southern Climate
 R-19 WALLS, R-38 CEILINGS, SLAB ON GRADE, .34-.36 U-VALUE .28-.30 SHGC
 WINDOWS, MED DRAPES 50%, FRONT DOOR FACES SOUTHEAST

Design Information

Weather: Austin/Bergstrom, TX, US

Winter Design Conditions

Outside db 30 °F
 Inside db 70 °F
 Design TD 40 °F

Summer Design Conditions

Outside db 99 °F
 Inside db 75 °F
 Design TD 24 °F
 Daily range M
 Relative humidity 50 %
 Moisture difference 29 gr/lb

Heating Summary

Structure 33467 Btuh
 Ducts 4788 Btuh
 Central vent (142 cfm) 6202 Btuh
 Humidification 0 Btuh
 Piping 0 Btuh
 Equipment load 44458 Btuh

Sensible Cooling Equipment Load Sizing

Structure 25861 Btuh
 Ducts 5310 Btuh
 Central vent (142 cfm) 3685 Btuh
 Blower 0 Btuh
 Use manufacturer's data y
 Rate/swing multiplier 1.00
 Equipment sensible load 34855 Btuh

Infiltration

Method Simplified
 Construction quality Tight
 Fireplaces 1 (Average)

	Heating	Cooling
Area (ft ²)	3163	3163
Volume (ft ³)	32019	32019
Air changes/hour	0.17	0.07
Equiv. AVF (cfm)	89	37

Latent Cooling Equipment Load Sizing

Structure 1520 Btuh
 Ducts 443 Btuh
 Central vent (142 cfm) 2740 Btuh
 Equipment latent load 4703 Btuh
 Equipment total load 39557 Btuh
 Req. total capacity at 0.78 SHR 3.7 ton

Heating Equipment Summary

Make GENERIC
 Trade 4.0 TON HEAT PUMP
 Model
 AHRI ref

Efficiency 8.4 HSPF
 Heating input
 Heating output 0 Btuh @ 47°F
 Temperature rise 0 °F
 Actual air flow 1600 cfm
 Air flow factor 0.042 cfm/Btuh
 Static pressure 0.85 in H2O
 Space thermostat

Cooling Equipment Summary

Make GENERIC
 Trade 4.0 TON HEAT PUMP
 Cond
 Coil
 AHRI ref
 Efficiency 12.5 EER, 15 SEER
 Sensible cooling 37440 Btuh
 Latent cooling 10560 Btuh
 Total cooling 48000 Btuh
 Actual air flow 1600 cfm
 Air flow factor 0.051 cfm/Btuh
 Static pressure 0.85 in H2O
 Load sensible heat ratio 0.88

Calculations approved by ACCA to meet all requirements of Manual J 8th Ed.



Duct System Summary

Entire House

Austin Air Conditioning, Inc.

Job: 3154 Sq.Ft.
 Date: 7/29/13
 By: MariaE.

13620 Immanuel Road, Pflugerville, TX 78660 Phone: 512-252-7711 Fax: 512-252-7744 Email: maria@austinairconditioning.com Web: www.austinairconditioning.com License: ...

Project Information

For: AHRI Project No.8002, The Impact of Duct Design
 on the Life Cycle of Residential HVAC Systems, Home #2, Metal Square/Round Duct

	Heating	Cooling
External static pressure	0.85 in H2O	0.85 in H2O
Pressure losses	0.35 in H2O	0.35 in H2O
Available static pressure	0.50 in H2O	0.50 in H2O
Supply / return available pressure	0.33 / 0.17 in H2O	0.33 / 0.17 in H2O
Lowest friction rate	0.112 in/100ft	0.112 in/100ft
Actual air flow	1600 cfm	1600 cfm
Total effective length (TEL)	447 ft	

Supply Branch Detail Table

Name	Design (Btuh)	Htg (cfm)	Clg (cfm)	Design FR	Diam (in)	H x W (in)	Duct Matl	Actual Ln (ft)	Ftg.Eqv Ln (ft)	Trunk
Bath 2	h 772	32	25	0.174	4.0	0x0	ShMt	40.0	150.0	st2A
Bed 2	h 1797	75	61	0.135	5.0	0x0	ShMt	29.5	215.0	st6
Bed 3	h 4053	170	97	0.115	7.0	0x0	ShMt	42.5	245.0	st5
Breakfast	h 5335	223	215	0.156	8.0	0x0	ShMt	52.6	160.0	st10
Dining	c 594	25	31	0.141	4.0	0x0	ShMt	19.5	215.0	st6
Family-A	c 2976	100	153	0.137	7.0	0x0	ShMt	37.4	205.0	st12
Family-B	c 2976	100	153	0.157	7.0	0x0	ShMt	30.9	180.0	st11
Game/Teen Rm	c 2866	131	147	0.128	7.0	0x0	ShMt	37.9	220.0	st4
Her WIC	h 1307	55	26	0.151	5.0	0x0	ShMt	44.4	175.0	st14
Kitchen	c 2756	93	141	0.155	7.0	0x0	ShMt	53.9	160.0	st10
Lav 2	c 60	2	3	0.125	4.0	0x0	ShMt	36.0	230.0	st2A
M Bath	h 2066	86	59	0.156	5.0	0x0	ShMt	37.2	175.0	st14
M Toilet	h 528	22	19	0.176	4.0	0x0	ShMt	38.2	150.0	st13
Master Bed	h 5196	217	200	0.138	8.0	0x0	ShMt	39.6	200.0	st8
Pwd	c 227	10	12	0.194	4.0	0x0	ShMt	21.0	150.0	st15
Study	c 3515	178	180	0.160	7.0	0x0	ShMt	17.5	190.0	st2
Utility	c 1047	17	54	0.193	4.0	0x0	ShMt	21.6	150.0	st15
WIC 3	h 1513	63	24	0.112	5.0	0x0	ShMt	51.4	245.0	st5

Supply Trunk Detail Table

Name	Trunk Type	Htg (cfm)	Clg (cfm)	Design FR	Veloc (fpm)	Diam (in)	H x W (in)	Duct Material	Trunk
st6	Peak AVF	1024	1124	0.135	826	13.5	14 x 14	ShtMetl	st1
st15	Peak AVF	27	65	0.193	479	5.0	0 x 0	ShtMetl	st6
st2A	Peak AVF	34	28	0.125	395	4.0	0 x 0	ShtMetl	st2
st2	Peak AVF	576	476	0.112	691	11.0	10 x 12	ShtMetl	st1
st3	Peak AVF	364	268	0.112	655	9.2	8 x 10	ShtMetl	st2
st4	Peak AVF	364	268	0.112	667	10.0	0 x 0	ShtMetl	st3
st5	Peak AVF	233	121	0.112	667	8.0	0 x 0	ShtMetl	st4
st10	Peak AVF	316	357	0.155	807	9.0	0 x 0	ShtMetl	st9
st7	Peak AVF	898	967	0.137	829	12.8	12 x 14	ShtMetl	st6
st8	Peak AVF	734	863	0.137	863	12.2	12 x 12	ShtMetl	st7
st13	Peak AVF	163	104	0.151	611	7.0	0 x 0	ShtMetl	st7
st14	Peak AVF	141	85	0.151	528	7.0	0 x 0	ShtMetl	st13
st9	Peak AVF	517	662	0.137	795	11.1	10 x 12	ShtMetl	st8
st11	Peak AVF	201	306	0.137	687	8.3	8 x 8	ShtMetl	st9
st12	Peak AVF	100	153	0.137	611	6.4	6 x 6	ShtMetl	st11
st1	Peak AVF	1600	1600	0.112	900	16.0	16 x 16	ShtMetl	

Return Branch Detail Table

Name	Grill Size (in)	Htg (cfm)	Clg (cfm)	TEL (ft)	Design FR	Veloc (fpm)	Diam (in)	H x W (in)	Stud/Joist Opening (in)	Duct Matl	Trunk
rb1	0x0	1600	1600	151.0	0.112	640	16.0	18x 20		ShMt	

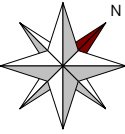

1ST FLOOR

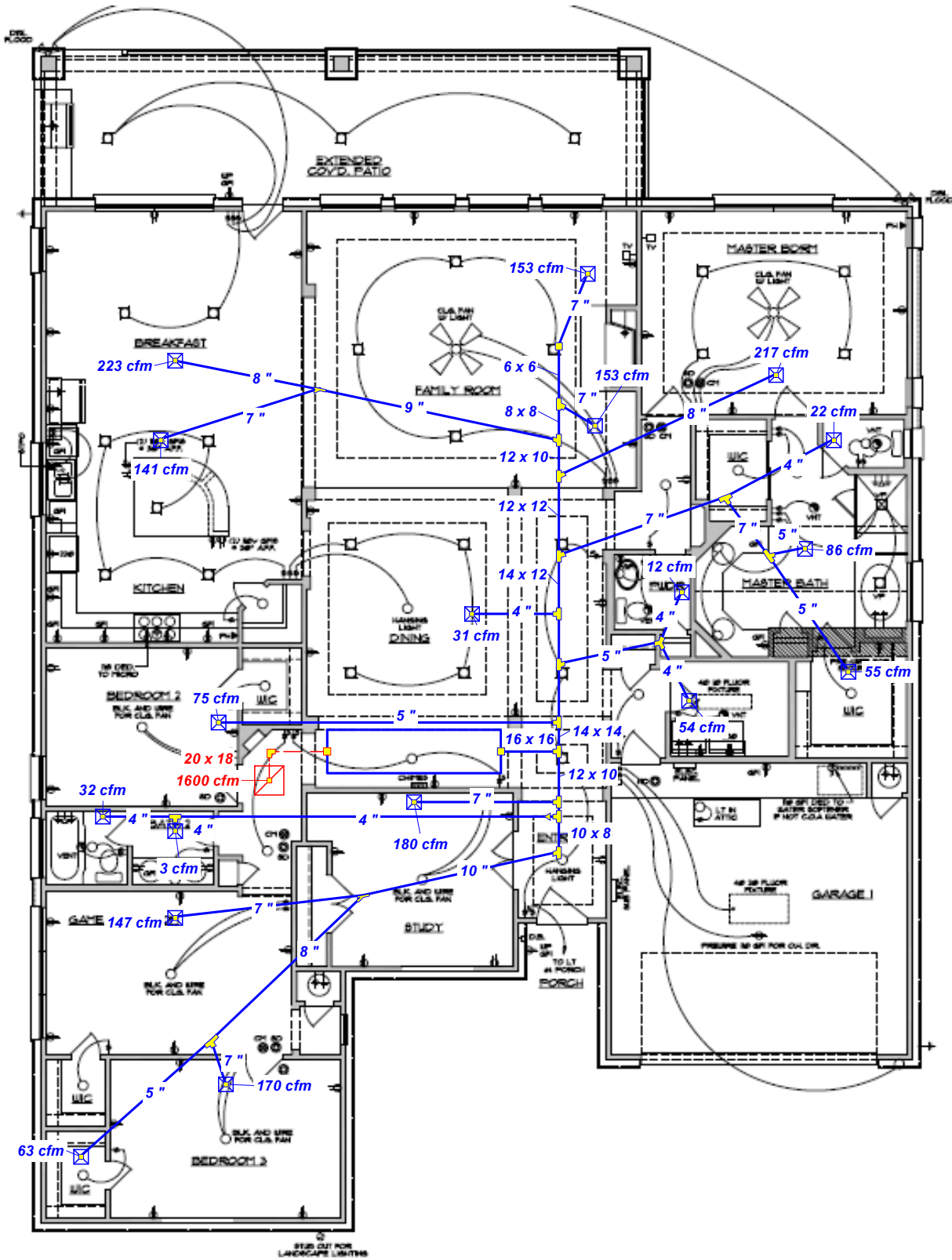

Job #: 3154 Sq.Ft.

Performed by Maria E. for:

AHRI Project No.8002
on the Life Cycle of Residential HVAC Systems
Home #2, Metal Square/Round Duct

Austin Air Conditioning, Inc.

13620 Immanuel Road
Pflugerville, TX 78660
Phone: 512-252-7711 Fax: 512-252-7744
www.austinairconditioning.com maria@austinairconditio...

Scale: 1 : 125

Page 1
Right-Suite® Universal 2012
12.1.08 RSU15282
2013-Jul-31 12:24:11
...2\Home #2 Metal 2 .50-.85 SP.rup



Project Summary
Entire House
 Austin Air Conditioning, Inc.

Job: 3154 Sq.Ft.
 Date: 7/29/13
 By: MariaE.

13620 Immanuel Road, Pflugerville, TX 78660 Phone: 512-252-7711 Fax: 512-252-7744 Email: maria@austinairconditioning.com Web: www.austinairconditioning.com License: ...

Project Information

For: AHRI Project No.8002, The Impact of Duct Design on the Life Cycle of Residential HVAC Systems, Home #2, Metal Square/Round Duct

Notes: Typical Single Story in a Southern Climate
 R-19 WALLS, R-38 CEILINGS, SLAB ON GRADE, .34-.36 U-VALUE .28-.30 SHGC
 WINDOWS, MED DRAPES 50%, FRONT DOOR FACES SOUTHEAST

Design Information

Weather: Austin/Bergstrom, TX, US

Winter Design Conditions

Outside db 30 °F
 Inside db 70 °F
 Design TD 40 °F

Summer Design Conditions

Outside db 99 °F
 Inside db 75 °F
 Design TD 24 °F
 Daily range M
 Relative humidity 50 %
 Moisture difference 29 gr/lb

Heating Summary

Structure 33467 Btuh
 Ducts 4788 Btuh
 Central vent (142 cfm) 6202 Btuh
 Humidification 0 Btuh
 Piping 0 Btuh
 Equipment load 44458 Btuh

Sensible Cooling Equipment Load Sizing

Structure 25861 Btuh
 Ducts 5310 Btuh
 Central vent (142 cfm) 3685 Btuh
 Blower 0 Btuh
 Use manufacturer's data y
 Rate/swing multiplier 1.00
 Equipment sensible load 34855 Btuh

Infiltration

Method Simplified
 Construction quality Tight
 Fireplaces 1 (Average)

	Heating	Cooling
Area (ft ²)	3163	3163
Volume (ft ³)	32019	32019
Air changes/hour	0.17	0.07
Equiv. AVF (cfm)	89	37

Latent Cooling Equipment Load Sizing

Structure 1520 Btuh
 Ducts 443 Btuh
 Central vent (142 cfm) 2740 Btuh
 Equipment latent load 4703 Btuh
 Equipment total load 39557 Btuh
 Req. total capacity at 0.78 SHR 3.7 ton

Heating Equipment Summary

Make GENERIC
 Trade 4.0 TON HEAT PUMP
 Model
 AHRI ref

Efficiency 8.4 HSPF
 Heating input
 Heating output 0 Btuh @ 47°F
 Temperature rise 0 °F
 Actual air flow 1600 cfm
 Air flow factor 0.042 cfm/Btuh
 Static pressure 1.15 in H2O
 Space thermostat

Cooling Equipment Summary

Make GENERIC
 Trade 4.0 TON HEAT PUMP
 Cond
 Coil
 AHRI ref
 Efficiency 12.5 EER, 15 SEER
 Sensible cooling 37440 Btuh
 Latent cooling 10560 Btuh
 Total cooling 48000 Btuh
 Actual air flow 1600 cfm
 Air flow factor 0.051 cfm/Btuh
 Static pressure 1.15 in H2O
 Load sensible heat ratio 0.88

Calculations approved by ACCA to meet all requirements of Manual J 8th Ed.





Duct System Summary

Entire House

Austin Air Conditioning, Inc.

Job: 3154 Sq.Ft.
 Date: 7/29/13
 By: MariaE.

13620 Immanuel Road, Pflugerville, TX 78660 Phone: 512-252-7711 Fax: 512-252-7744 Email: maria@austinairconditioning.com Web: www.austinairconditioning.com License: ...

Project Information

For: AHRI Project No.8002, The Impact of Duct Design
 on the Life Cycle of Residential HVAC Systems, Home #2, Metal Square/Round Duct

	Heating	Cooling
External static pressure	1.15 in H2O	1.15 in H2O
Pressure losses	0.35 in H2O	0.35 in H2O
Available static pressure	0.80 in H2O	0.80 in H2O
Supply / return available pressure	0.53 / 0.27 in H2O	0.53 / 0.27 in H2O
Lowest friction rate	0.179 in/100ft	0.179 in/100ft
Actual air flow	1600 cfm	1600 cfm
Total effective length (TEL)		447 ft

Supply Branch Detail Table

Name	Design (Btuh)	Htg (cfm)	Clg (cfm)	Design FR	Diam (in)	H x W (in)	Duct Matl	Actual Ln (ft)	Ftg.Eqv Ln (ft)	Trunk
Bath 2	h 772	32	25	0.279	4.0	0x0	ShMt	40.0	150.0	st2A
Bed 2	h 1797	75	61	0.217	5.0	0x0	ShMt	29.5	215.0	st6
Bed 3	h 4053	170	97	0.184	7.0	0x0	ShMt	42.5	245.0	st5
Breakfast	h 5335	223	215	0.249	8.0	0x0	ShMt	52.6	160.0	st10
Dining	c 594	25	31	0.226	4.0	0x0	ShMt	19.5	215.0	st6
Family-A	c 2976	100	153	0.219	7.0	0x0	ShMt	37.4	205.0	st12
Family-B	c 2976	100	153	0.251	7.0	0x0	ShMt	30.9	180.0	st11
Game/Teen Rm	c 2866	131	147	0.205	7.0	0x0	ShMt	37.9	220.0	st4
Her WIC	h 1307	55	26	0.242	4.0	0x0	ShMt	44.4	175.0	st14
Kitchen	c 2756	93	141	0.248	7.0	0x0	ShMt	53.9	160.0	st10
Lav 2	c 60	2	3	0.199	4.0	0x0	ShMt	36.0	230.0	st2A
M Bath	h 2066	86	59	0.250	5.0	0x0	ShMt	37.2	175.0	st14
M Toilet	h 528	22	19	0.282	4.0	0x0	ShMt	38.2	150.0	st13
Master Bed	h 5196	217	200	0.221	8.0	0x0	ShMt	39.6	200.0	st8
Pwd	c 227	10	12	0.310	4.0	0x0	ShMt	21.0	150.0	st15
Study	c 3515	178	180	0.255	7.0	0x0	ShMt	17.5	190.0	st2
Utility	c 1047	17	54	0.309	4.0	0x0	ShMt	21.6	150.0	st15
WIC 3	h 1513	63	24	0.179	5.0	0x0	ShMt	51.4	245.0	st5

Supply Trunk Detail Table

Name	Trunk Type	Htg (cfm)	Clg (cfm)	Design FR	Veloc (fpm)	Diam (in)	H x W (in)	Duct Material	Trunk
st6	Peak AVF	1024	1124	0.217	826	12.3	14 x 14	ShtMetl	st1
st15	Peak AVF	27	65	0.309	749	4.0	0 x 0	ShtMetl	st6
st2A	Peak AVF	34	28	0.199	395	4.0	0 x 0	ShtMetl	st2
st2	Peak AVF	576	476	0.179	829	10.0	10 x 10	ShtMetl	st1
st3	Peak AVF	364	268	0.179	818	8.4	8 x 8	ShtMetl	st2
st4	Peak AVF	364	268	0.179	823	9.0	0 x 0	ShtMetl	st3
st5	Peak AVF	233	121	0.179	667	8.0	0 x 0	ShtMetl	st4
st10	Peak AVF	316	357	0.248	807	9.0	0 x 0	ShtMetl	st9
st7	Peak AVF	898	967	0.219	829	11.6	12 x 14	ShtMetl	st6
st8	Peak AVF	734	863	0.219	863	11.1	12 x 12	ShtMetl	st7
st13	Peak AVF	163	104	0.242	831	6.0	0 x 0	ShtMetl	st7
st14	Peak AVF	141	85	0.242	719	6.0	0 x 0	ShtMetl	st13
st9	Peak AVF	517	662	0.219	795	10.1	10 x 12	ShtMetl	st8
st11	Peak AVF	201	306	0.219	687	7.6	8 x 8	ShtMetl	st9
st12	Peak AVF	100	153	0.219	611	5.8	6 x 6	ShtMetl	st11
st1	Peak AVF	1600	1600	0.179	900	14.6	16 x 16	ShtMetl	

Return Branch Detail Table

Name	Grill Size (in)	Htg (cfm)	Clg (cfm)	TEL (ft)	Design FR	Veloc (fpm)	Diam (in)	H x W (in)	Stud/Joist Opening (in)	Duct Matl	Trunk
rb1	0x0	1600	1600	151.0	0.179	640	14.6	18x 20		ShMt	

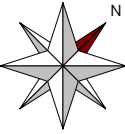

1ST FLOOR

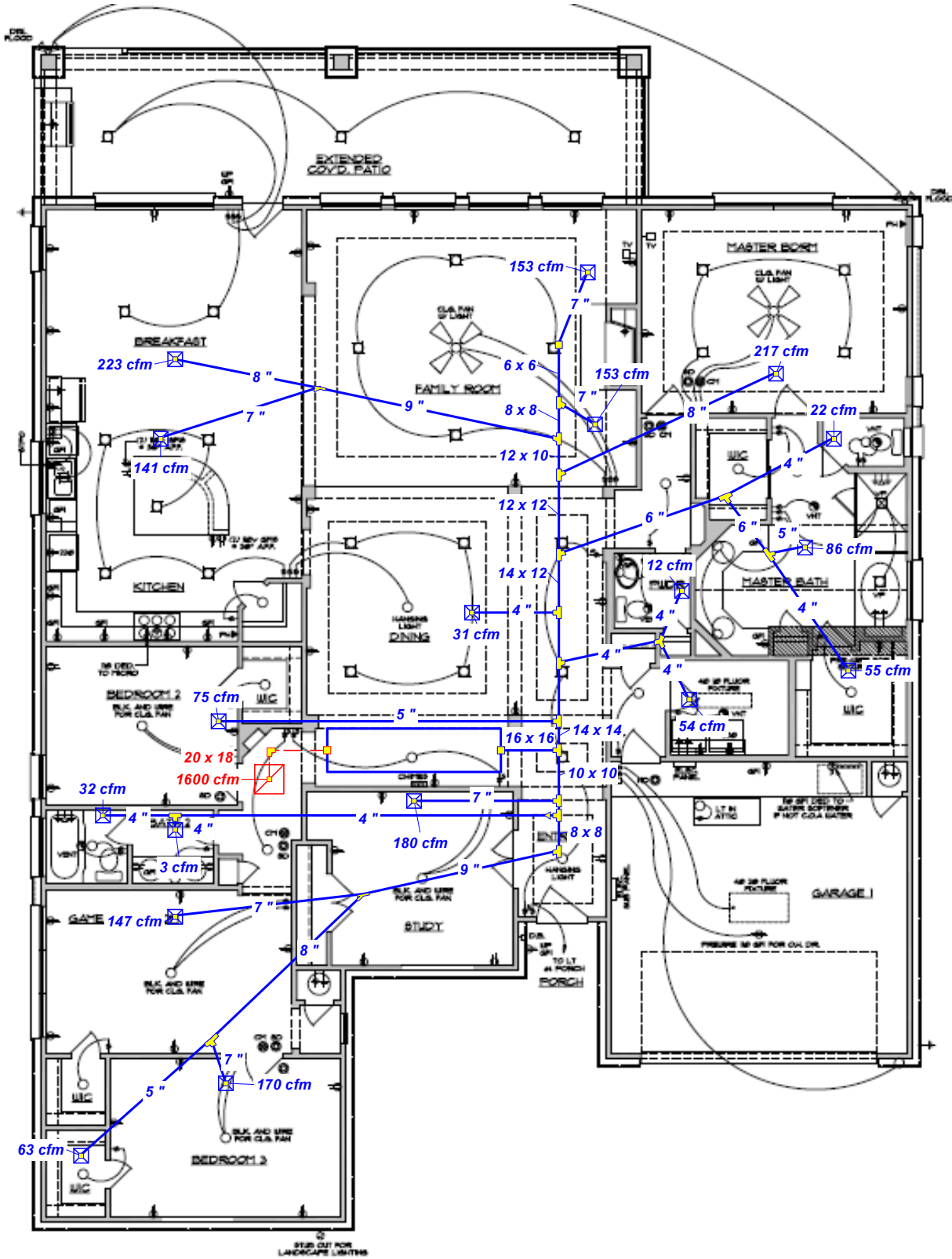

Job #: 3154 Sq.Ft.

Performed by Maria E. for:

AHRI Project No.8002
on the Life Cycle of Residential HVAC Systems
Home #2, Metal Square/Round Duct

Austin Air Conditioning, Inc.

13620 Immanuel Road
Pflugerville, TX 78660
Phone: 512-252-7711 Fax: 512-252-7744
www.austinairconditioning.com maria@austinairconditio...

Scale: 1 : 125

Page 1
Right-Suite® Universal 2012
12.1.08 RSU15282
2013-Jul-31 12:27:05
...\\Home #2 Metal 3 .80-1.15 SP.rup