



AHRI Project No. 8016: Risk Assessment of Class 2L Refrigerants in Commercial Rooftop Units

Prepared for:



we make life better™

Prepared by:

Bill Goetzler
Matt Guernsey
Sean Faltermeier
Michael Droesch

Navigant Consulting, Inc.
77 South Bedford St.
Suite 400
Burlington, MA 01803

781.270.0101
www.navigant.com

Final Report
May 2016



Table of Contents

- E. Executive Summary vi**
 - E.1 Objective vi
 - E.2 Approach vi
 - E.3 Findingsvii
- 1. Introduction1-1**
 - 1.1 Background 1-1
 - 1.2 Objective 1-1
- 2. Risk Assessment Background2-1**
 - 2.1 Summary 2-1
 - 2.2 FTA Scenarios 2-2
- 3. Fault Tree Structure3-2**
 - 3.1 Fault Tree Basics 3-2
 - 3.2 Primary Operating-State Branches 3-2
 - 3.2.1 Installation and Servicing 3-4
 - 3.2.2 Normal Operation..... 3-4
 - 3.3 Analyzed Refrigerants 3-5
- 4. Input Modeling4-6**
 - 4.1 Refrigerant Leak Data 4-6
 - 4.2 Ignition Sources 4-6
 - 4.3 CFD Analysis of Refrigerant Leaks..... 4-8
 - 4.3.1 CFD Scenarios..... 4-8
 - 4.3.2 CFD Results 4-10
 - 4.3.3 CFD Conclusions and Assumptions for FTA..... 4-12
 - 4.4 Local Air Velocity Effects 4-16
- 5. Fault Tree Analysis Results5-17**
 - 5.1 Overall Risk Results 5-17
 - 5.2 Ignition Risk by Refrigerant..... 5-17
- 6. Conclusions6-1**
 - 6.1 Risk Drivers..... 6-1
 - 6.2 Overall Risk Findings 6-1
 - 6.3 Operating State Impacts 6-1
 - 6.4 Leak Location Impacts..... 6-2
 - 6.5 Return Ducting Configuration Impacts for Ground-Mounted Units 6-3
 - 6.6 Comparison to Known Risk Levels 6-3
 - 6.7 Mitigation Strategies 6-4

6.8	Future Work.....	6-5
Appendix A. Leak Data Calculations and AssumptionsA-1		
A.1	Leak Data.....	A-1
A.2	Assumption for Leak Data Calculations	A-2
Appendix B. CFD Model Assumptions and Inputs B-1		
B.1	Refrigerant Properties.....	B-1
B.2	Assumed Equipment Operating Parameters.....	B-1
B.3	CFD Scenario Assumptions	B-2
B.4	Modeled CFD Geometry Diagrams.....	B-2
B.5	Monitoring Points for CFD Analysis	B-9
Appendix C. CFD Leak Rate PlotsC-1		
Appendix D. CFD Results Summary Tables..... D-1		
Appendix E. CFD Local Velocity Results E-1		

List of Figures and Tables

Figures:

Figure 2.1. Fault Tree Analysis Development Methodology	2-2
Figure 3.1. Example FTA Branches.....	3-2
Figure 3.2: Example Top Fault Tree (Scenario A).....	3-3
Figure 4.1: Model of Representative Commercial Kitchen	4-9
Figure 4.2: Screenshot of Flammable Concentrations Developed from a Fast Evaporator Leak of R-1234yf from a 15 Ton RTU on a Commercial Kitchen at 52 s after the Leak Began	4-12
Figure 6.1: Modeled Geometry of 15T RTU Serving a Commercial Kitchen, Side View	B-3
Figure 6.2: Layout of a Commercial Kitchen Served by a 15T RTU, Overhead View	B-3
Figure 6.3: Layout of a Commercial Kitchen Served by a 15T RTU, Side View	B-4
Figure 6.4: Modeled Geometry for an Office Served by a 25T RTU, Side View.....	B-4
Figure 6.5: Layout of an Office Served by a 25T RTU, Side View	B-5
Figure 6.6: Layout of an Office Served by a 25T RTU, Overhead View	B-5
Figure 6.7: Modeled Geometry for an Office Served by a Ground-Mounted 5T RTU with Vertical Return Ducting, Side View	B-6
Figure 6.8: Modeled Geometry for an Office Served by a Ground-Mounted 5T RTU with Horizontal Return Ducting, Side View	B-6
Figure 6.9: Modeled Geometry for an Office Served by a Ground-Mounted 5T RTU with Horizontal Return Ducting, Overhead View	B-7
Figure 6.10: Modeled Geometry of 15T and 25T RTUs	B-7
Figure 6.11: Modeled Geometry for Condenser Leak in 25T Roof-Mounted RTU Serving an Office.....	B-8
Figure 6.12: Modeled Geometry for 5T RTU Serving an Office	B-8
Figure 6.13: Modeled Geometry and Monitoring Points for Scenarios 1, 2, 3, and 10	B-9
Figure 6.14: Modeled Geometry and Monitoring Points for Scenarios 4 and 5	B-9
Figure 6.15: Modeled Geometry and Monitoring Points for Scenario 6.....	B-10
Figure 6.16: Modeled Geometry and Monitoring Points for Scenario 7.....	B-10
Figure 6.17: Modeled Geometry and Monitoring Points for Scenarios 8 and 9	B-11
Figure 6.18: Leak rate versus time for Scenarios 1 and 3 – Fast evaporator leaks of R-32 from a 15T roof-mounted RTU serving a commercial kitchen	C-1
Figure 6.19: Leak rate versus time for Scenarios 2 and 10 – Fast evaporator leaks of R-1234yf from a 15T roof-mounted RTU serving a commercial kitchen.....	C-1
Figure 6.20: Leak rate versus time for Scenario 4 – Slow evaporator leak of R-32 from a 25T roof-mounted RTU serving an office.....	C-2
Figure 6.21: Leak rate versus time for Scenarios 5 and 6 – Fast evaporator and condenser leaks of R-32 from a 25T roof-mounted RTU serving an office	C-2
Figure 6.22: Leak rate versus time for Scenarios 7 and 8 – Fast evaporator leaks of R-32 from a 5T ground-mounted RTU serving an office.....	C-3
Figure 6.23: Leak rate versus time for Scenario 9 – Fast evaporator leak of R-1234yf from a 5T ground-mounted RTU serving an office.....	C-3
Figure 6.24: Concentration vs Time for Scenario 1 – Fast evaporator leak of R-32 from a 15T roof-mounted RTU serving a commercial kitchen	E-2
Figure 6.25: Local Velocity vs Time for Scenario 1 – Fast evaporator leak of R-32 from a 15T roof-mounted RTU serving a commercial kitchen	E-2

Figure 6.26: Concentration vs Time for Scenario 2 – Fast evaporator leak of R-1234yf from a 15T roof-mounted RTU serving a commercial kitchen E-3

Figure 6.27: Local Velocity vs Time for Scenario 2 – Fast evaporator leak of R-1234yf from a 15T roof-mounted RTU serving a commercial kitchen E-3

Tables:

Table 1: Risk Scenariosvii
 Table 2: Total Annual Risk of Ignition by Scenario..... viii

Table 2-1: Common Refrigerant Flammability Characteristics 2-1
 Table 2-2: Risk Scenarios..... 2-1
 Table 3-1: Summary of Operating States in Fault Tree Analysis for All Analyzed Scenarios..... 3-3
 Table 4-1: Leak Frequency Data Summary 4-6
 Table 4-2: Analyzed Ignition Sources by Location and Operating Mode 4-8
 Table 4-3: CFD Scenarios 4-8
 Table 4-4: Refrigerant Charge Assumptions 4-10
 Table 4-5: Summary of CFD Analysis Results 4-10
 Table 4-6: Conclusions and Assumptions from CFD Results for a 15T Roof-Mounted RTU Serving a Commercial Kitchen..... 4-13
 Table 4-7: Conclusions and Assumptions from CFD Results for a 25T Roof-Mounted RTU Serving an Office 4-14
 Table 4-8: Conclusions and Assumptions from CFD Results for a 5T Ground-Mounted RTU Serving an Office 4-15
 Table 4-9: Estimated Fractions of Region with Velocity Below 2.5 times Refrigerant Burning Velocity. 4-16
 Table 5-1: Fault Tree Analysis Results by Scenario (in Descending Order of Risk) 5-17
 Table 5-2: Daily FTA Results by Operating State 5-17
 Table 6-1: Safety Hazard Risk (Annual Frequency) Levels for Various Activities 6-4
 Table 6-2: Leak Estimates Provided by the AHRI 8016 PMS..... A-1
 Table 6-3: Leak Data for a 15T Roof-Mounted RTU Serving a Commercial Kitchen A-1
 Table 6-4: Leak Data for a 25T Roof-Mounted RTU Serving an Office A-1
 Table 6-5: Leak Data for a 5T Ground-Mounted RTU Serving an Office..... A-2
 Table 6-6: Assumptions used for Calculation of Leak Data..... A-2
 Table 6-7: Refrigerant Properties B-1
 Table 6-8: Assumed Equipment Operating Parameters B-1

E. Executive Summary

As concerns about the global warming potential (GWP) of common fluorocarbon refrigerants have mounted in recent years, lower-GWP refrigerants have garnered increasing attention. Industry is now focusing on a new group of alternative refrigerants with low GWP, some of which are flammable and classified as 2L (ASHRAE 34). Manufacturers of most commercial HVAC equipment, such as commercial rooftop units (RTUs), have not begun using these refrigerants due to the flammability concerns of large amounts of refrigerant. AHRI has determined that a comprehensive risk assessment is needed to help the HVAC industry evaluate the feasibility of using Class 2L refrigerants in RTU systems.

E.1 Objective

The primary objective of this project is to assess the safety risks associated with the use of Class 2L refrigerants in RTUs. Specifically, we investigate the risks of using refrigerants such as R-32 and R-1234yf during normal operation and installation/servicing for several RTU locations and building types. A fault tree analysis forms the basis for this risk assessment.

E.2 Approach

The fault tree analysis (FTA) followed these steps:

1. Define the system and activities
2. Characterize the leak scenarios and build fault trees
3. Estimate frequency of each hazard scenario
4. Calculate overall risks
5. Compare to other known risk levels
6. Evaluate mitigation strategies

FTA is an approach to failure/risk analysis which uses Boolean logic to combine individual events that may lead to a specific system failure. Fault trees are built on the risks or likelihood of failure of various components or events in the system. Each individual component is connected in the tree depending on whether a failure of one component or all components is required for a system or subsystem to fail. To calculate predicted risk of the system, we use a minimal cut sets approach which includes designated Boolean logic operators and all unique combinations of events that lead to an overall failure.

The basic structure of the fault tree contains two primary branches, one for each unique operating state: installation and servicing with the blower off, and normal operation. Within the normal operation branch, there are sub-branches for normal operation with the blower on and off. The sub-branch for normal operation with the blower on also includes servicing with the blower on. This analysis does not cover manufacturing and transportation risk, as they are outside of the scope of this study. When combining the individual risk associated with each of the primary branches, we weighted each branch by the expected annual duration for each operating state.

Within each branch, we evaluate total predicted risk based on several probabilities, including the likelihood of: a refrigerant leak, development of flammable concentrations of leaked refrigerant, presence of an active ignition source, and a local velocity that does not exceed a threshold above which refrigerant ignition is not possible. We identified potential ignition sources and the probability of occurrence for each

one through literature review and discussion with the AHRI 8016 PMS. The AHRI PMS also provided leak frequency data that were used in each of the analyzed scenarios. Table 1 describes each scenario.

Table 1: Risk Scenarios

Scenario	Refrigerant	Equipment	Building	Description
A	R-32	15T on Roof	Kitchen	Two-circuit unit (5 ton and 10 ton capacities) mounted on the roof directly above the conditioned space, which consists of just the kitchen space (no dining areas).
B	R-1234yf			
C	R-32	25T on Roof	Office	Two-circuit unit (12.5 ton capacity each) mounted on the roof directly above the conditioned space; return and supply ducts serve multiple office spaces.
D	R-1234yf			
E	R-32	5T on Ground	Office	Single-circuit RTU that is mounted on the ground adjacent to the conditioned space; multiple return ducting configurations are addressed, including directly ducted horizontally, and ducted vertically up into the roof of the building.
F	R-1234yf			

E.3 Findings

Table 1 shows the risk of ignition for each of the six scenarios under each operating state: normal operation, and installation and servicing with blower off. The predicted risk for normal operation is split to distinguish the difference in risk when the blower is and is not operating. The total risk is an average of the risk in each operating state, weighted by the time per year in each state.

Table 1: Fault Tree Analysis Results for Daily Risk by Scenario and Operating State

Daily Risk of Ignition (Occurrences/Installation/Day) by Operating State (10^{-10})			
Scenario	Normal Operation		Installation and Servicing with Blower Off
	Blower Off	Blower On	
A	3.1	0	5.0
B	0.67	0	1.1
C	0.000084	0	0.23
D	0.000032	0	0.088
E	0.000017	0	0.053
F	0.0000066	0	0.020

Note: Multiply each value by 10^{-10} to yield the full daily risk value

Table 2 shows the total annual risk for each of the five scenarios. These data are the probabilities for refrigerant ignition per year in each scenario.

Table 2: Total Annual Risk of Ignition by Scenario

Scenario	Refrigerant	Equipment	Location	Annual Risk of Ignition*
A	R-32	15T on Roof	Kitchen	3.9 E-8
B	R-1234yf	15T on Roof	Kitchen	8.5 E-9
C	R-32	25T on Roof	Office	8.0 E-11
D	R-1234yf	25T on Roof	Office	3.0 E-11
E	R-32	5T on Ground	Office	1.8 E-11
F	R-1234yf	5T on Ground	Office	7.0 E-12

* Units for Risk are occurrences (refrigerant ignitions) per scenario per year

The key findings include:

- Velocity effects:** The majority of the region that develops a refrigerant concentration between the LFL and UFL is not flammable because the local velocity exceeds 2.5 times the refrigerant’s burning velocity. While we believe our approach is the best available, it likely overestimates the ignition risk from leaks of R-1234yf.
- Blower operation:** CFD results indicate that there is no risk of ignition from a leak that occurs while the RTU blower is operating. Operation of the blower rapidly disperses any flammable plume and creates velocities high enough that refrigerant cannot be ignited. To reduce risk of leaked refrigerant ignition, RTUs could use refrigerant monitors that would send a signal to the control system for the blower and condenser fan to begin operating when a refrigerant leak is detected. Operation of the blower and/or condenser fan would help to quickly dissipate leaked refrigerant.
- Annual risk:** The normal operation risk constitutes the vast majority of the total risk for the commercial kitchen scenarios because the normal operating state prevails for 99% of the year. However, for the office scenarios, the risk during installation and servicing with the blower off constitutes the majority of the total risk because of the much higher ignition risk from a brazing torch (which would not be present in normal operation) than from any other analyzed ignition sources for these scenarios.
- Normal operation vs. installation and servicing:** For the office scenarios the predicted risk during installation is several orders of magnitude higher than the risk during normal operation with the blower off (e.g., at night). This large difference in predicted risk occurs because we assumed that a brazing torch could be present inside or outside the RTU during installation or servicing with the blower off. However, for the kitchen scenarios (A and B), the ignition risk during installation and servicing with the blower off is only 65% higher than the risk during normal operation with the blower off because of the presence of gas pilot lights on cooking equipment.
- Gas pilot lights:** For the kitchen scenarios, gas pilot lights present a larger ignition risk than do any other ignition sources. Therefore, the replacement of pilot lights for cooking appliances with electronic igniters would significantly reduce the likelihood of ignition in a kitchen. FTA results for Scenarios A and B indicate that removal of pilot lights as a potential ignition source reduces the ignition risk by two to three orders of magnitude.

- **Refrigerant:** Risk of ignition for the two examined refrigerants – R-32 and R-1234yf – differs because of the significantly higher minimum ignition energy (MIE) of R-1234yf versus R-32, the significantly lower burning velocity of R-1234yf versus R-32, and because the two refrigerants have different flow characteristics and charges required. However, the main driver for differing ignition risks is the lower burning velocity of R-1234yf. FTA results from Scenarios A and B show that the risk of ignition for R-1234yf is 22% of the risk for R-32 from an RTU serving a kitchen. We estimate the risk of ignition for R-1234yf to be 38% of that for R-32 in Scenarios C-F; this ratio differs from that for Scenarios A and B because the office scenarios do not include pilot lights on cooking equipment.
- **Return ducting configuration for ground-mounted RTUs:** The ignition risk in the conditioned space is negligible for ground-mounted RTUs with a vertical return ducting configuration because the leaked refrigerant does not reach the top of the return duct and therefore does not enter the conditioned space. The ignition risk in the conditioned space is higher for ground-mounted RTUs with a horizontal return ducting configuration, but the risk is significantly lower than the risk of ignition in the conditioned space in other scenarios. In this configuration (compared to a vertical ducting configuration), leaked refrigerant does not need to rise through the duct to reach the conditioned space, and the return duct is significantly shorter, providing less volume for the leaked refrigerant to occupy before reaching the conditioned space. The only identified ignition source in the office served by a ground-mounted RTU with a horizontal return ducting configuration is a spark that might occur from appliances such as a computer or mini-fridge.
- **Leak location:** During normal operation, the ignition risk is higher for an evaporator leak than for a condenser leak because the evaporator leak has the potential to introduce refrigerant into the conditioned space, which can lead to higher refrigerant concentrations in the presence of more ignition sources. This is true for all scenarios except the office served by a ground-mounted RTU because a cigarette lighter was deliberately not analyzed in this scenario. A cigarette lighter was not analyzed for this scenario because CFD results indicate that the flammable plume either does not rise about the office floor (horizontal return ducting) and a cigarette lighter would not be used at floor level, or never reaches the conditioned space (vertical return ducting). During installation, the ignition risk is higher for evaporator leaks than condenser leaks in kitchen scenarios, but is higher for condenser leaks than evaporator leaks in office scenarios. The risk is higher for condenser leaks than evaporator leaks in the office scenarios because gas pilot lights were not considered for office scenarios; therefore, a brazing torch, which was considered as an ignition source during installation was the highest risk ignition source.

1. Introduction

1.1 Background

As concerns about the global warming potential (GWP) of common fluorocarbon refrigerants have mounted in recent years, lower GWP refrigerants have garnered increasing attention. However, some alternatives present poor safety and/or performance tradeoffs in exchange for lower GWP. For example, hydrocarbons' flammability makes them hazardous in many applications. Carbon dioxide's thermodynamic cycle efficiency is lower than that of typical HFCs, and its properties are so different from fluorocarbons that they necessitate a complete and costly system redesign.

ASHRAE standard 34-2013 includes a new safety classification, 2L, for refrigerants with low burning velocity.¹ These refrigerants are difficult to ignite and have relatively benign burning characteristics when ignited. Newly developed hydrofluoroolefin (HFO) refrigerants are viable 2L candidates that may provide the necessary level of safety and low GWP to suit industry needs. Further, some 2L refrigerants can also provide the desired thermodynamic efficiency. For example, HFC-32 has a substantially lower GWP than HFC-410A (the most common refrigerant used in many HVAC applications), but can also achieve high system efficiencies. HFO refrigerants, such as HFO-1234yf, attract interest from many key industry players because of their near-zero GWP and because they too provide good performance.

In order to help the HVAC industry evaluate the viability of using various lower GWP refrigerants in commercial air conditioning systems, a comprehensive risk assessment must be performed. The results of this evaluation, combined with information about system costs, will form the basis for decisions regarding the market introduction of systems using 2L refrigerants.

1.2 Objective

The primary objective of this project is to assess the ignition risk associated with leaks of A2L refrigerants in commercial rooftop units (RTU) for heating, ventilation, and air conditioning (HVAC). Specifically, the investigation determines the predicted ignition risks during installation, service, and operation of RTUs using A2L refrigerants, focusing on HFC-32 and HFO-1234yf.

¹ Based on the definition of refrigerant classes in the ASHRAE 34 standard. The flammability classification uses the numbers 1, 2, and 3, where class 1 has "no flame propagation," class 2 has "lower flammability," and class 3 has "higher flammability." Class 2L is a specific subclass of class 2, and has lower flammability than the other class 2 refrigerants based on the burning velocity.

2. Risk Assessment Background

2.1 Summary

The risk assessment generates risk probabilities of refrigerant vapor ignition in the event of a 2L refrigerant leak from an RTU. Per AHRI Project Monitoring Subcommittee (PMS) guidance, Navigant only evaluated the likelihood of an ignition event (excluding the severity or consequences of such an event). We did not evaluate the risks of a fire due to refrigerant ignition, which includes additional, highly variable factors such as the amount of flammable material in close proximity to the unit and ignition source, as well as the room layout and building materials.

The two refrigerants under scrutiny were R-32 and R-1234yf. They represent very different flammability characteristics, despite both being A2L refrigerants. In comparison to R-1234yf, R-32's minimum ignition energy (MIE) is more than two orders of magnitude lower, but R-32's burning velocity (BV) is more than four times faster. However, R-32 does have a lower flammability limit (LFL) that is higher than that of R-1234yf, which reduces the risk of ignition. Table 2-1 shows the flammability characteristics of the refrigerants of interest in this study.

Table 2-1: Common Refrigerant Flammability Characteristics²

Refrigerant	Class*	LFL (kg/m ³ @ 21 °C)	UFL (kg/m ³ @ 21 °C)	MIE (mJ)	BV (cm/s)	AIT (°C)
Direction of Lower Risk for Variable	NA	Higher	Lower	Higher	Lower	Higher
R-32	A2L	0.307	0.625	30	6.7	648
R-1234yf	A2L	0.299	0.593	5,000	1.5	405
R-1234ze(E)	A2L	N/A	N/A	61,000		368
Additional refrigerant for comparison						
R-290 (Propane)	A3	0.038	0.152	0.25	46	540

*By definition, 2L refrigerants are those in Class 2 that have a burning velocity less than 10 cm/s
 Note: LFL = lower flammability limit, UFL = upper flammability limit, MIE = minimum ignition energy, AIT = Auto-ignition temperature, BV = burning velocity.

Based on PMS guidance, we also incorporated an additional risk characteristic into the fault tree analysis based on research that indicates that when the local air velocity is more than 2.5 times the burning velocity of the refrigerant, the refrigerant will not ignite (see section 4.4 for additional discussion). R-1234yf is much more sensitive to this factor given its much lower burning velocity than that of R-32.

Figure 2.1 shows the process by which we conducted the fault tree analysis (FTA), including the gathering of input data.

² Denis Clodic, "Low GWP Refrigerants and Flammability Classification," Mines ParisTech, Table 2, p.6, available at: <http://www.nedo.go.jp/content/100080128.pdf>

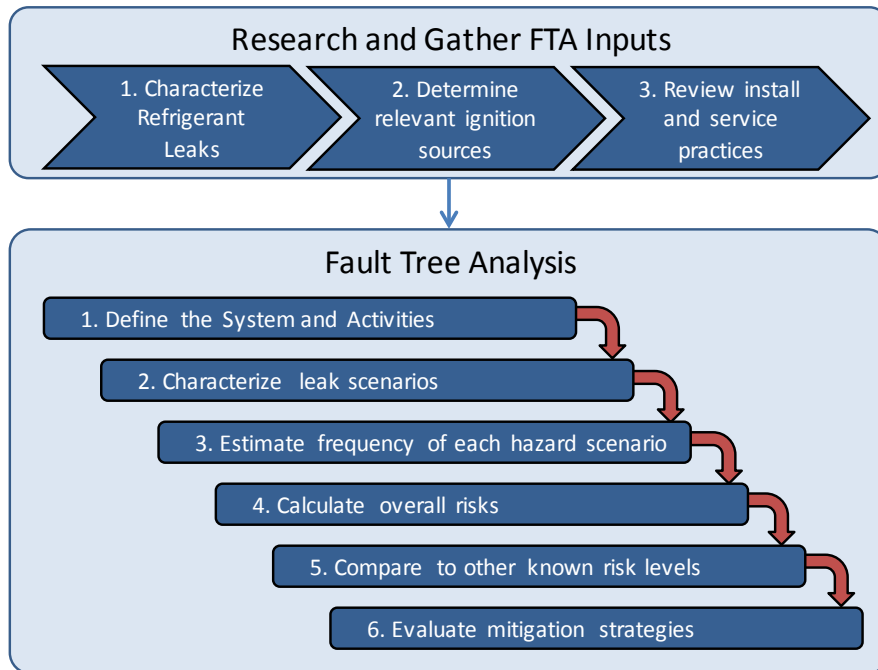

Figure 2.1. Fault Tree Analysis Development Methodology

2.2 FTA Scenarios

Table 2-2 shows the six scenarios for fault tree analysis defined for this project, in coordination with the PMS. Each scenario represents a unique combination of risk situation and refrigerant, and Navigant developed one risk probability for each scenario.

Table 2-2: Risk Scenarios

Scenario	Refrigerant	Equipment	Building	Description
A	R-32	15T on Roof	Kitchen	Two-circuit unit (5 ton and 10 ton capacities) mounted on the roof directly above the conditioned space, which consists of just the kitchen space (no dining areas).
B	R-1234yf			
C	R-32	25T on Roof	Office	Two-circuit unit (12.5 ton capacity each) mounted on the roof directly above the conditioned space; return and supply ducts serve multiple office spaces.
D	R-1234yf			
E	R-32	5T on Ground	Office	Single-circuit RTU that is mounted on the ground adjacent to the conditioned space; multiple return ducting configurations are considered, including directly ducted horizontally, and ducted vertically up into the roof of the building.
F	R-1234yf			

For the ground-mounted RTU modeled in Scenarios E and F, Navigant modeled two different return venting configurations – one with a horizontal return duct that passes directly from the ground-mounted RTU to the office through a grill in the office wall, and one with a vertical return duct that rises up the outside wall and enters the office through the ceiling, similar to the supply duct. Both of these configurations were included in the FTA for Scenarios E and F.

3. Fault Tree Structure

3.1 Fault Tree Basics

Fault tree analysis (FTA) is an approach to failure/risk analysis which uses Boolean logic to combine individual events that may lead to a specific system failure. Figure 3.1 shows example fault tree components. In this figure, diamonds represent initiating event probabilities (e.g., component failures or leaks). Those events can be combined with an AND or an OR gate, as Figure 3.1 shows, to identify a combined probability. The output of an OR gate occurs if any of the inputs occurs, whereas the output of an AND gate occurs only if all the inputs occur. To calculate predicted risk of the top level event, the software uses these mathematical probability rules to determine the to-level probability.

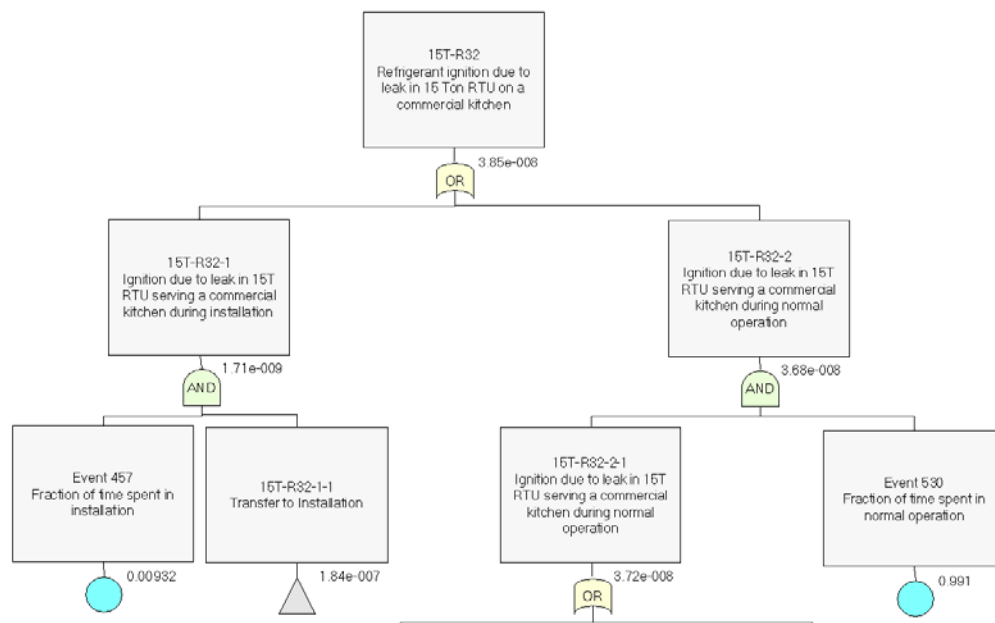

Figure 3.1. Example FTA Branches

3.2 Primary Operating-State Branches

The FTA for each of the scenarios in this analysis contains two primary branches, one for each unique operating state: installation and servicing, and normal operation. Table 3-1 describes each operating state. Normal operation is split into two sub-branches – one for when the blower is running, and one for when the blower is off. Servicing with the blower off was analyzed together with installation, as we assumed both would include similar ignition risks. Servicing with the blower on was analyzed as part of normal operation. This analysis does not cover manufacturing and transportation risk, as they are outside of the scope of this study. Sections 3.2.1 through 3.2.2 describe each operating state in greater detail.

Table 3-1: Summary of Operating States in Fault Tree Analysis for All Analyzed Scenarios

Operating State	Days/yr.
Installation & Servicing – Installation and startup time, both for new construction and replacements; may vary by installation depending on the additional work required for roof curbs, roofing repairs, or ducting maintenance/repair. Additionally includes both emergency servicing and regularly scheduled periodic maintenance when the blower is off. Primarily focuses on additional risks associated with having technicians in and around the unit with greater potential for leaks and also more common presence of ignition sources.	3
Normal Operation – Typical operating circumstances when RTU is not being installed or serviced with the blower off (RTU may or may not be running) (e.g., occupied hours of any season); accounts for differences in ignition probabilities when blower is on or off. Also includes servicing with blower on, which would likely include minor repairs and regularly scheduled periodic maintenance.	362

Note: This division of days per year by operating state was used for all analyzed RTU locations (i.e., commercial kitchen, office with ground-mounted or roof-mounted RTU).

Figure 3.2 shows an example of the top levels of a fault tree, which produces the likelihood of refrigerant ignition at an RTU over the course of one year. This tree aggregates the predicted risks during different operating states into the total predicted risk. The yellow OR labels represent gates where the output occurs if any of the input gates occur; the green AND labels represent gates where the output occurs if all of the input gates occur.

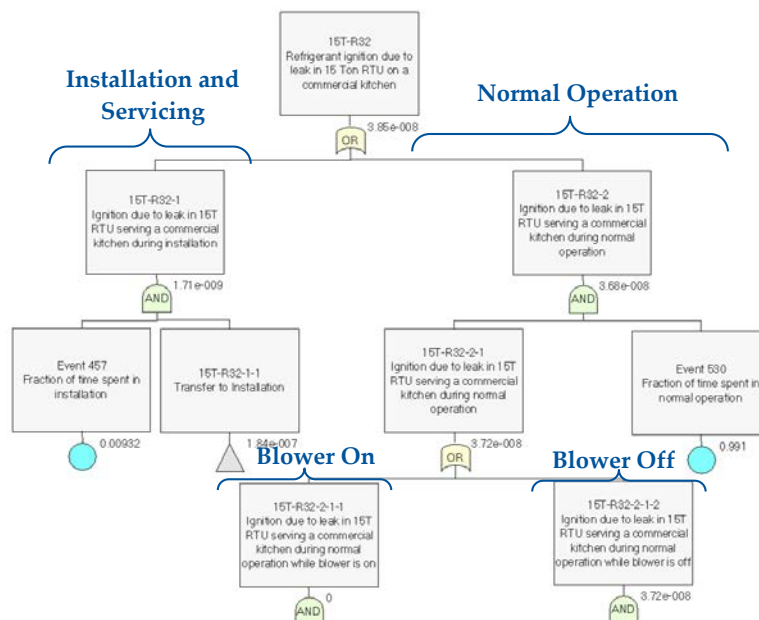

Figure 3.2: Example Top Fault Tree (Scenario A)

The annual fractions in this top tree add up to a full year of operation and are based on the hours per operating state in Table 3-1. With this approach, we can analyze the comparable, per-day risk on a given sub-branch (i.e., operating state), as well as the total annual risk for a given scenario.

3.2.1 Installation and Servicing

The installation and servicing branch covers the period of time when technicians and/or other contractors put the RTU into place, make all necessary electrical and ducting connections, charge the machine (if necessary), commission the system, and conduct servicing or repairs that require the blower to be off. In this state the indoor blower and the condenser fan are assumed to be off. With the indoor blower and condenser fan off, the likelihood of a leak creating a flammable refrigerant concentration is greater. However, with the RTU off, the likelihood of a leak actually occurring is reduced because the RTU is subject to fewer mechanical forces, such as high and/or fluctuating pressures and vibrations. We believe the primary leak risks are due to the following: (1) a leak due to improper venting of refrigerant or purging during brazing or replacement of components; and (2) accidents in which someone or something comes in contact with the RTU, thereby rupturing a refrigerant line or otherwise causing a rapid release of refrigerant. In the second case, technicians or others are often able to take precautions to reduce the risk of ignition of the leaked refrigerant; however, the impact of such precautions is difficult to quantify.

This branch includes decommissioning and replacement installations (replace on failure) as well as new construction installations. Many replacement installations coincide with major building upgrades and other construction, so the scenario is very similar to a new construction installation. If the replacement installation does not coincide with any major construction, the ignition risks may be reduced relative to a new construction installation. Accident-caused leaks are inherently less likely in this case because there are fewer people, less activity, and less large machinery in the vicinity of the RTU.

In new construction projects, RTUs are generally installed shortly before the building becomes occupied, so we assume that normal operation begins immediately following installation and startup.

This branch also includes all servicing and repairs that require the blower to be turned off. We estimate that an RTU undergoes an average of 4 days of servicing per year, and that 80% of time in servicing is spent with the blower off. Similar to installation, servicing specifically addresses technician-occupied time because such work presents a unique set of ignition risks that would not be present during operator-occupied periods.

3.2.2 Normal Operation

Normal operation is defined as the typical, day-to-day operation of the RTU, including both on- and off-cycle operation. This state is characterized by few, if any, people in close proximity to the RTU. Normal operation is the predominant operating state for the RTU; we estimate that it runs in this state for 362 days per year, or 99% of the time. Normal operation also includes servicing with the blower on. This servicing includes annual and regular servicing that does not require the blower to be shut off. On average, we assume 4 days of servicing per year, and that the blower is operating for only 20% of the time spent in servicing.

For each scenario, normal operation is divided into two sub-branches based on whether the indoor blower and condenser fan are running. The blower, if active, will help evacuate any leaked refrigerant from the room and generally reduce the potential for flammable concentrations to accumulate. In general, the blower is on during occupied hours and off for unoccupied hours. However, during unoccupied hours, the HVAC system will turn on as necessary to keep the temperature within a pre-determined

range. Further, during the hottest part of the cooling season, the RTU may run nearly constantly in order to ensure that the building is at the set temperature when it is scheduled to be occupied in the morning.

- **Normal operation, blower on** – includes all hours scheduled for occupancy for a typical facility, as well as any periods scheduled for no occupancy when space conditioning is still required (e.g., to maintain a maximum setpoint or to reach the occupied-setpoint prior to when the building is actually occupied). For a typical office building on weekdays, the ventilation system may turn on at 6 am and shut down at 8 pm. On weekends, the ventilation may be on for some period of time depending on when it is scheduled to be occupied. This period also includes servicing while the blower is on.
- **Normal operation, blower off** – includes all hours scheduled for no occupancy, except for those when the HVAC system is actively running to condition the space. For the kitchen scenarios, we assumed that kitchen ventilation hoods would not be operating when the RTU is not operating, because we considered the conditioned space to have no occupancy when the blower is off. Operation of kitchen ventilation hoods would significantly reduce the likelihood of ignition of leaked refrigerant in the kitchen by rapidly dispersing any flammable plumes.

3.3 Analyzed Refrigerants

As mentioned in Section 2.2, Navigant analyzed six scenarios, which include combinations of three different RTU locations and two different refrigerants: R-32 and R-1234yf. However, fault trees were not constructed for the office scenarios with R-1324yf (Scenarios D and F). Fault trees were constructed for all three scenarios for R-32 (A, C, E), and for the commercial kitchen for R-1234yf (B). We then developed an estimate for a multiplicative factor by which the risk changes from leaks of R-32 and R-1234yf from the commercial kitchen fault trees, and applied this factor to the two office scenarios to develop risk probability estimates for R-1234yf (D and F).

Because we did not model the presence of gas pilot lights in commercial offices in Scenarios C-F and the ignition risk from pilot lights of cooking equipment is the major contributor to the ignition risk in Scenarios A and B, we removed the ignition risk of gas pilots from this factor. Specifically, we recalculated ignition risks for Scenarios A and B after decreasing the fraction of kitchens with gas pilots running overnight from 0.72 to 0. After this adjustment, the ignition risks for Scenarios A and B are significantly lower, and have different drivers.

4. Input Modeling

Each of the two primary branches (one each for normal operation, and installation and servicing, see section 3.2, above) contains five primary variables (probabilities) that drive the ignition risk:

- Refrigerant leak (either fast or slow)
- Flammable concentration develops in same location as ignition source as a result of the refrigerant leak (informed by CFD analysis)
- Presence of active ignition source during period of flammable refrigerant buildup
- Ignition source is active with energy greater than the refrigerant minimum ignition energy (MIE)
- Flammable concentrations are not in a region with local velocity greater than 2.5x the refrigerant burning velocity (this issue is further discussed in section 4.4)

The sections below discuss the data collection, modeling, and analysis used to develop FTA inputs for each of these variables.

4.1 Refrigerant Leak Data

For the purposes of this study, Navigant relied on AHRI data for refrigerant leak frequency data, which included two different leak values for each scenario based on the operating state: one for normal operation, and a second for installation and servicing with the blower off. Table 4-1 shows a summary of leak-frequency data used in the FTA, and all leak-frequency data used (including all examined combinations of RTU size/location, operating state, leak speed, circuit, and RTU compartment) are shown in Appendix A. These leak-frequency data represent the total number of leaks in the population divided by the size of the population. In the ensuing analyses, the team assumed that these leak frequency data could be applied as representative of the leak potential of any single RTU installed and operated over a one-year period.

Table 4-1: Leak Frequency Data Summary

Operating state at time of leak	5T RTU (5T Circuit)	15T RTU (10T Circuit)	25T RTU (12.5T Circuit)
RTU Location	Ground	Roof	Roof
Normal Operation	0.01	0.01	0.01
Installation and Servicing	0.006	0.004	0.004
Source: Provided by AHRI 8016 PMS			

4.2 Ignition Sources

The team used data from the literature review, discussions with PMS members, and other sources to compile a list of ignition sources potentially present near RTUs. For each potential ignition source, Navigant researched the frequency and duration of the source being present.

The identified ignition sources are as follows:

- **Hot surface** – malfunctioning heating element in an RTU or space heater
- **Electrical spark** – could occur from failed motor, faulty appliance, spark igniter, wiring short, or high voltage contactor
- **Brazing torch** – could be used during installation or servicing
- **Cigarette lighter**
- **Gas-fired equipment** – including cooking and water heating equipment

However, several of the ignition sources identified above were not included in the FTA due to an assumed negligible risk. We assumed that the likelihood that a heating element in the RTU (as part of an electrical heating system) would heat despite the blower being off would be negligible. We also assumed that a malfunctioning heating element in a space heater would not have sufficient energy to ignite 2L refrigerants, because we were unable to find any data or sources indicating that such an element would provide energy higher than the MIE of R-32 or R-1234yf. Additionally, we did not include pilot lights from gas-fired water heating equipment because CFD results informed the assumption that flammable refrigerant concentrations would not develop in proximity to a likely location for a water heater. Flames and spark igniters from gas-fired cooking equipment in operation or being turned on were also not included, because CFD results showed that flammable concentrations would not develop in the kitchen with the blower on, and we assumed the kitchen would not be in operation with the RTU off. However, pilot lights of gas-fired cooking equipment were considered as potential ignition sources, because we assumed that pilot lights would be operating constantly (anecdotally, few restaurants ever shut off pilots), meaning that any leaked refrigerant co-located with a pilot light that reaches a flammable concentration will ignite.

Table 4-2 shows the ignition sources that the team considered for each scenario and operating mode analyzed.

Table 4-2: Analyzed Ignition Sources by Location and Operating Mode

Location	Ignition Source	Kitchen (Scenarios A, B)		Office – on rooftop (Scenarios C, D)		Office – on ground (Scenarios E, F)	
		Normal Operation	Installation and Servicing	Normal Operation	Installation and Servicing	Normal Operation	Installation and Servicing
Outside RTU	Cigarette lighter	✓	✓	✓	✓	✓	✓
	Brazing torch		✓		✓		✓
Inside RTU	Spark	✓	✓	✓	✓	✓	✓
	Brazing torch		✓		✓		✓
In Conditioned Space	Pilot (cooking equipment)	✓	✓				
	Spark	✓	✓	✓	✓	✓*	✓*
	Cigarette lighter	✓	✓	✓	✓		

* In the scenarios with a ground-mounted RTU serving an office, ignition within the conditioned space was only analyzed for RTUs with a horizontal return ducting configuration, because CFD results from Scenarios 7 and 8 show that flammable concentrations only develop in the office with this ducting configuration.

4.3 CFD Analysis of Refrigerant Leaks

4.3.1 CFD Scenarios

Navigant conducted computational fluid dynamics (CFD) modeling to inform the inputs in the FTA for flammable concentrations of leaked refrigerant. Table 4-3 describes each of the 10 CFD runs. The scenarios covered each of the relevant variables under investigation in the FTA that pertain to the refrigerant leak, including equipment type and location, return ducting configuration, refrigerant, leak characteristics, leak location, and model boundaries. Appendix B.4 provides detailed layouts of each of the three RTU sizes (25 ton, 15 ton, and 5 ton) and of the three unique spaces that they serve (commercial kitchen, office served by roof-mounted RTU, and office served by ground-mounted RTU).

Table 4-3: CFD Scenarios

#	Equipment Type	Ref.	Location	Leak Type	Leak Location /Condition	Model Boundaries	Notes
1	15T on rooftop	R-32	Comm. Kitchen	Fast	Evaporator – Blower off	RTU, ducting and kitchen space	Exhaust hoods off
2	15T on rooftop	R-1234yf	Comm. Kitchen	Fast	Evaporator – Blower off	RTU, ducting and kitchen space	Exhaust hoods off
3	15T on rooftop	R-32	Comm. Kitchen	Fast	Evaporator – Blower on	RTU, ducting and kitchen space	Exhaust hoods off, assumed min. blower speed
4	25T on rooftop	R-32	Office	Slow	Evaporator – Blower off	RTU, ducting and office space	

#	Equipment Type	Ref.	Location	Leak Type	Leak Location /Condition	Model Boundaries	Notes
5	25T on rooftop	R-32	Office	Fast	Evaporator – Blower off	RTU, ducting and office space	
6	25T on rooftop	R-32	Office	Fast	Condenser – Condenser Fan Off	RTU and surrounding space	Assumed low wind speed (1 m/s)
7	5T on ground	R-32	Office	Fast	Evaporator – Blower off	RTU, ducting and office space	Supply & return ducts run vertically to roof
8	5T on ground	R-32	Office	Fast	Evaporator – Blower off	RTU, ducting and office space	Same as #7, but with horizontal return air ducting
9	5T on ground	R-1234yf	Office	Fast	Evaporator – Blower off	RTU, ducting and office space	Same as #8 with different refrigerant
10	15T on rooftop	R-1234yf	Comm. Kitchen	Fast	Evaporator – Blower on	RTU, ducting and kitchen space	Same as #3 with different refrigerant

Navigant defined representative building and HVAC system geometries for each scenario, based on the types of building architectures that are most common and potentially present the greatest risk to ignition from A2L refrigerant leaks. Figure 4.1 shows a model designed to represent a typical commercial kitchen, complete with cooking stations, preparation stations, exhaust hoods, and the RTU and ventilation system.

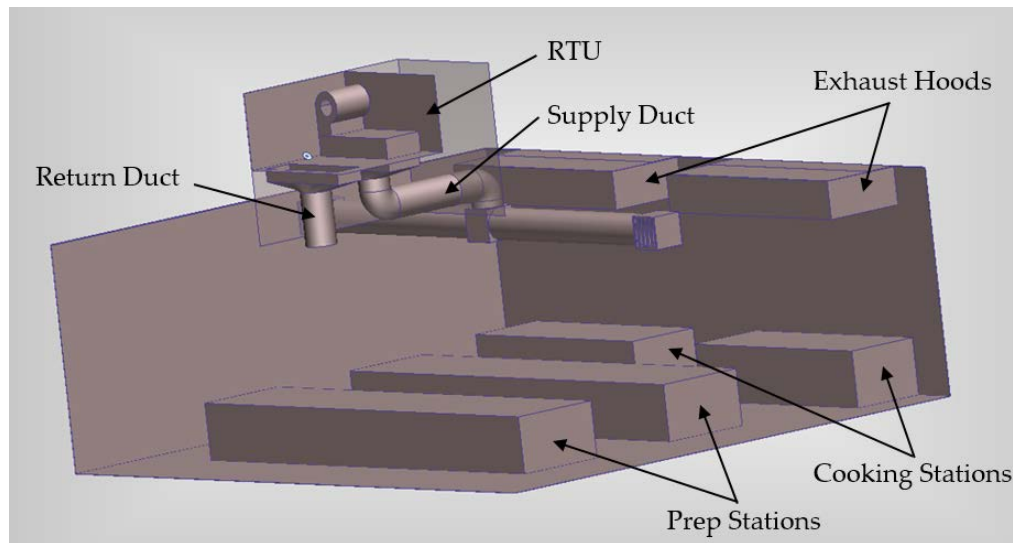

Figure 4.1: Model of Representative Commercial Kitchen

Navigant developed assumptions for the mass of refrigerant charges for each RTU size and refrigerant based on the typical charge required for a similarly size unit using R-410A, scaled to account for changes in refrigerant heat capacity. We obtained these R-410A charges from manufacturer literature for RTUs that are currently on the market at each capacity. Each scenario modeled a leak of the entire refrigerant charge in a single circuit except for Scenario 4 (a slow leak) which we ended after 2910 seconds and a release of 59% of the refrigerant at which point the conclusions were clear. For the 15T RTU, we assumed

that the leak was in the larger of the two circuits (10T and 5T) per the statement of work, representing a worst-case scenario. Table 4-4 shows the refrigerant charge assumptions used.

Table 4-4: Refrigerant Charge Assumptions

CFD Scenarios	RTU Size (Tons)	Leaked Circuit Size (Tons)	Refrigerant	Refrigerant Charge in Leaked Circuit (lbs)
1,3	15	10	R-32	12
2,10	15	10	R-1234yf	17
4,5,6	25	12.5	R-32	23
7,8	5	5	R-32	7
9	5	5	R-1234yf	10

For each scenario, we assumed the refrigerant was in a gaseous state with pressure equalized across the circuit. We modeled a decaying leak rate based on the changing pressure differential between the refrigerant circuit and the ambient as refrigerant is released; this approach was validated in leak-chamber testing for ASHRAE project 1580.³ Appendix B includes details on leak rates as well as other assumptions and refrigerant properties used in the CFD analysis.

4.3.2 CFD Results

The CFD simulations were valuable in helping Navigant understand how refrigerant leaks propagate and form flammable plumes. Specifically, the CFD analysis illustrated which types of leaks were most likely to generate flammable concentrations in which locations. In addition to the flammable concentrations as quantified by areas between the LFL and UFL, Navigant also considered the local velocity in relation to the refrigerant burning velocity because the refrigerants under evaluation do not ignite at velocities sufficiently greater than their burning velocities. Section 4.4 includes detail on the analyzed threshold for local velocity as well as further discussion of local air velocity impacts. We quantified the effect of local velocity on the likelihood of ignition in the FTA separately from the likelihood of flammable plumes developing, as defined by concentrations between the LFL and UFL. In the following tables, discussion of “flammable concentrations” refers only to concentrations between the LFL and UFL, regardless of local velocity.

Navigant was particularly concerned with identifying which leak scenarios would cause flammable plumes in each of three primary locations: inside the RTU and ventilation system, outside the RTU (and outside the building), and inside the conditioned space. Table 4-5 summarizes at a high level the flammable concentration buildup for each location in each CFD scenario.

Table 4-5: Summary of CFD Analysis Results

#	Did a substantial plume accumulate with a flammable concentration?		
	Inside the RTU/Ventilation	In Conditioned Space	Outside the RTU
1	●	◐	○
2	●	◐	○

³ Goetzler, W; Burgos, J; “Study of Input Parameters for Risk Assessment of 2L Flammable Refrigerants in Residential Air Conditioning and Commercial Refrigeration Applications,” (2012).

#	Did a substantial plume accumulate with a flammable concentration?		
	Inside the RTU/Ventilation	In Conditioned Space	Outside the RTU
3			
4			
5			
6			
7			
8			
9			
10			

Legend:
 - Substantial Flammable Plume
 - Small Flammable Plume
 - No Flammable Plume

Navigant analyzed the results of each scenario, including plots of refrigerant concentration over time and video simulations of leak propagation, and used the findings to estimate the risk of a leak forming a flammable concentration under different conditions. Figure 4.2 shows an example of the type of 3-dimensional simulations that were conducted. This image is filtered to show only flammable concentrations in the commercial kitchen, spanning from the LFL (blue) to the UFL (red) for R-1234yf (CFD Scenario 2).

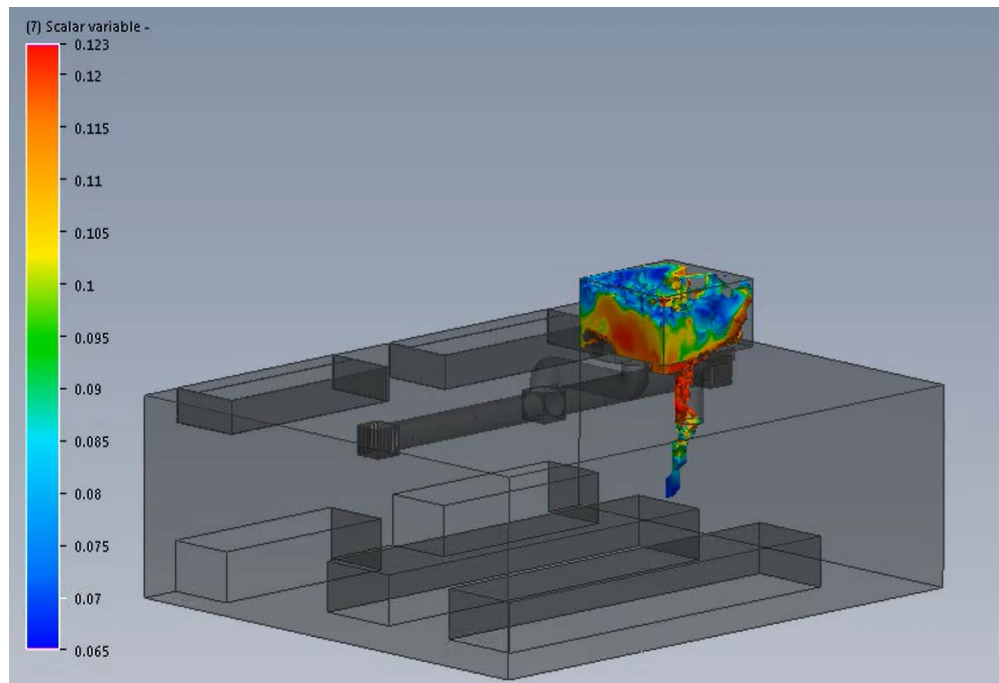

Figure 4.2: Screenshot of Flammable Concentrations Developed from a Fast Evaporator Leak of R-1234yf from a 15 Ton RTU on a Commercial Kitchen at 52 s after the Leak Began

Navigant compiled all of the key results from each modeled scenario in summary tables. Appendix D includes summary tables for all scenarios. We also examined the distribution of local velocity within the modeled spaces – this analysis is described in section 4.4, and CFD results for this analysis are shown in Appendix D.

4.3.3 CFD Conclusions and Assumptions for FTA

The CFD analysis provided valuable input to the FTA on the likelihood of flammable plumes arising from various leak scenarios. Specific outputs of the CFD analysis included concentration data over time at specified monitoring points, as well as videos that visualize each CFD scenario and the corresponding refrigerant concentration in the building space over time. While the videos are not as precise as concentration data at each monitoring point, the videos provide a more complete picture of how the leak propagates and of the duration of any flammable plumes. Further, the monitoring points may not represent the points with highest refrigerant concentration. Navigant used both the concentration data and videos to quantify how refrigerant leaks propagate, leading to a better-informed risk assessment. In addition to this report, Navigant is delivering the set of CFD output video files. Please see these files for additional detail.

Table 4-6, Table 4-7, and Table 4-8 show the assumptions that the team drew from the CFD analysis and applied toward the FTA for development of flammable concentrations in the conditioned space and the outside air surrounding the RTU for a 15 ton RTU serving a commercial kitchen, a 25 ton roof-mounted RTU serving an office, and a 5 ton ground-mounted RTU serving an office, respectively. These assumptions apply to leaks of both R-32 and R-1234yf. These tables also show the CFD conclusions from which the team formed its assumptions. The final column indicates the modeled scenarios which provided these conclusions.

Table 4-6: Conclusions and Assumptions from CFD Results for a 15T Roof-Mounted RTU Serving a Commercial Kitchen

ID	Leak Speed	Leak Location	Blower/ Fan Status	Assumption	Conclusion from Modeled Scenarios	CFD Scenario
I	Fast	Evaporator	Off	Flammable concentrations develop in the kitchen in the immediate vicinity of the return duct.	Flammable concentrations developed in a plume extending down ~5 ft from the return duct for leaks of R-32 and R-1234yf.	1, 2
II	Fast /Slow	Evaporator /Condenser	On	Flammable concentrations do not develop outside of the vicinity of the leak.	With the blower operating, leaked refrigerant quickly dispersed and only reached trace amounts (<5% of LFL) outside the RTU.	3, 10
III	Slow	Evaporator	Off	Flammable concentrations do not develop in the kitchen.	For a slow evaporator leak of R-32 in a 25T RTU, R-32 entered the office but did not develop a flammable concentration there.	4
IV	Fast	Condenser	Off	With low wind speed, flammable concentrations develop inside the RTU and briefly outside the RTU.	For a fast leak of R-32 with the fan off in a 25T RTU, flammable concentrations developed for ~1 min inside the RTU, and outside the RTU within 10 ft of the RTU with low wind speed (1 m/s).	6
V	Slow	Condenser	Off	Flammable concentrations only develop inside the RTU.	For a slow evaporator leak of R-32 in a 25T RTU, leaked refrigerant entered the office but did not develop a flammable concentration in the room.	4

Table 4-7: Conclusions and Assumptions from CFD Results for a 25T Roof-Mounted RTU Serving an Office

ID	Leak Speed	Leak Location	Blower/ Fan Status	Assumption	Conclusion from Modeled Scenarios	CFD Scenario
VI	Fast	Evaporator	Off	Flammable concentrations develop in the office within several feet of the return duct.	For a fast evaporator leak of R-32, flammable concentrations developed in the office in a plume extending down several feet from the return duct.	5
VII	Fast /Slow	Evaporator /Condenser	On	Flammable concentrations do not develop outside of the vicinity of the leak.	With the blower operating, any leaked refrigerant quickly dispersed and only reached trace amounts (<5% of LFL) outside a 15T RTU.	3, 10
VIII	Slow	Evaporator	Off	Flammable concentrations do not develop in the office.	For a slow evaporator leak of R-32, leaked R-32 entered the office but did not develop a flammable concentration there.	4
IX	Fast	Condenser	Off	Flammable concentrations briefly develop inside the RTU and in the vicinity of the RTU with low wind speed.	For a fast leak of R-32 with the fan off in a 25T RTU, flammable concentrations developed for ~1 min inside the RTU, and outside the RTU within 10 ft of the RTU with low wind speed (1 m/s).	6
X	Slow	Condenser	Off	Flammable concentrations only develop inside the RTU.	For a slow evaporator leak in a 25T RTU, R-32 entered the office but did not develop a flammable concentration in the room.	4

Table 4-8: Conclusions and Assumptions from CFD Results for a 5T Ground-Mounted RTU Serving an Office

ID	Leak Speed	Leak Location	Blower /Fan Status	Return Duct Entrance	Assumption	Conclusion from Modeled Scenarios	CFD Scenario
XI	Fast /Slow	Evaporator	Off	Ceiling	Flammable concentrations only develop inside the RTU and in the horizontal portion of the return duct until dissipation via the outdoor air inlet.	For a fast R-32 leak in a 5T RTU with a ceiling return duct entrance, flammable concentrations developed inside the RTU and in the horizontal portion of the return duct.	7
XII	Fast	Evaporator	Off	Wall	Flammable concentrations develop inside the RTU, return duct, and around the office floor.	For a fast leak in a 5T RTU with a wall return duct entrance, flammable concentrations developed inside the RTU, return duct, and around the office floor (~25% of the floor for R-32 and ~50% of the floor for R-1234yf).	8, 9
XIII	Fast /Slow	Evaporator /Condenser	On	Ceiling /Wall	Flammable concentrations do not develop outside of the vicinity of the leak.	With the blower operating, any leaked refrigerant from a 15T RTU quickly dispersed and only reached trace amounts outside the RTU.	3, 10
XIV	Slow	Evaporator /Condenser	Off	Wall	Flammable concentrations only develop inside the RTU.	For a slow leak, R-32 entered the office but did not develop a flammable concentration there.	4
XV	Fast	Condenser	Off	Ceiling /Wall	Flammable concentrations briefly develop inside the RTU and in the vicinity of the RTU with low wind speed.	For a fast leak of R-32 with the fan off in a 25T RTU, flammable concentrations developed for ~1 min inside the RTU, and outside the RTU within 10 ft of the RTU with low wind speed (1 m/s).	6

4.4 Local Air Velocity Effects

If leaked 2L refrigerants form a flammable concentration (as defined by a concentration between the LFL and UFL) in the presence of an ignition source with sufficient energy, ignition is still dependent upon the local velocity. This is because the burning velocities of these 2L refrigerants (including R-32 and R-1234yf) are below 10 cm/s. Members of the IEC TC61/SC61D/WG9 working group have generally accepted that ignition of a 2L refrigerant requires a local velocity less than approximately 2.5 times the refrigerant burning velocity.⁴ Therefore, we examined the distribution of local velocity within the modeled spaces for CFD Scenarios 1 and 2 to characterize which regions have a velocity less than this threshold. The results from this analysis of local velocity for these scenarios are shown in Appendix D. Because of the turbulent air flow caused by a leak (particularly a fast leak), the resulting entrained air flow, and outdoor wind, CFD results indicate that a significantly large region of the modeled spaces (inside and outside the RTU, in the conditioned space) will have a local velocity greater than this threshold. We used these CFD results to develop approximations of the fraction of volumes with flammable concentration that also have a local velocity less than 2.5 times the refrigerant burning velocity, for each refrigerant.

For an R-32 leak in CFD Scenario 1, we observed that most of all modeled regions had velocities greater than 2.5 times the burning velocity of R-32. As shown in results in Appendix E, few observed monitoring points had a local velocity below this threshold. Based on these results, we estimated fractions of the volume of each analyzed space that would have a local velocity less than 2.5 times the burning velocity of R-32. For a leak of R-1234yf in CFD Scenario 2, no analyzed monitoring points showed a local velocity less than 2.5 times the burning velocity of R-1234yf. However, because discrete monitoring points cannot represent the velocity distribution in the entire room, we did not assume that there was zero chance of the local velocity falling below this threshold for a leak of R-1234yf. Instead, we conservatively estimated the risk of falling below this velocity threshold by scaling down the fractions estimated for R-32, based on the ratio of burning velocity for each refrigerant (1.5/6.7). Therefore, our results likely overestimate the ignition risk for leaks of R-1234yf. These estimated fractions for both refrigerants are shown in Table 4-9. The fraction of the region outside the RTU was not estimated using CFD results, but using an estimate from a study performed for AHRI by Gradient (AHRI 8009, 2015) that no wind conditions occur approximately 6% of the time.⁵ Because this estimate is for no wind and not for low wind speeds, this fraction does not vary by refrigerant.

Table 4-9: Estimated Fractions of Region with Velocity Below 2.5 times Refrigerant Burning Velocity

Location	R-32	R-1234yf
Conditioned space	10%	2%
Office with horizontal ducting	25%	6%
Inside RTU	33%	7%
Outside RTU	6%	6%

⁴ This value of 2.5 times the refrigerant’s burning velocity was determined through discussion with the PMS and with Osami Kataoka of Daikin Industries. While no published studies are available that provide refined values, their experience suggests that the value is between 2 and 3 times the burning velocity; thus we assume 2.5 times as an average. As such, this is only a guideline that is helpful in better understanding the risk, but is not an absolute. Members of IEC TC61/SC61D/WG9 in general accept this as a valid means of relative assessment.

⁵ Gradient “Risk Assessment of Refrigeration Systems Using A2L Refrigerants,” (2015).

5. Fault Tree Analysis Results

5.1 Overall Risk Results

To calculate the risk of ignition, the minimal cut sets approach was used for each fault tree. A minimal cut set refers to a combination of basic events that leads to the top event occurring only if all basic events occur (i.e., a cut set is not minimal if it includes basic events that do not need to occur for the top event to occur). The minimal cut set approach analyzes all minimal cut sets that lead to occurrence of the top event. The highest-risk scenario is Scenario A, at approximately 4 E-8, or 1 ignition per 25 million units per year. Table 5-1 shows the individually calculated total annual risks for each scenario.

Table 5-1: Fault Tree Analysis Results by Scenario (in Descending Order of Risk)

Scenario	Refrigerant	Equipment	Location	Annual Risk of Ignition*
A	R-32	15T on Roof	Kitchen	3.9 E-8
B	R-1234yf	15T on Roof	Kitchen	8.5 E-9
C	R-32	25T on Roof	Office	8.0 E-11
D	R-1234yf	25T on Roof	Office	3.0 E-11**
E	R-32	5T on Ground	Office	1.8 E-11
F	R-1234yf	5T on Ground	Office	7.0 E-12**

* Units for Risk are occurrences (refrigerant ignitions) per scenario per year

** Results for Scenarios D and F were obtained by scaling results from Scenarios C and E, based on the relative risks for ignition of R-32 and R-1234yf observed from Scenarios A and B. This scaling is further discussed in section 5.2.

To quantify the risk of ignition during the different operating states of each scenario, we calculated the predicted risk for the individual sub-trees of the fault tree. Table 5-2 shows the risk components for each operating state, on a daily basis. The total risk is lower than that for installation and servicing with the blower off but higher than that for normal operation in all scenarios, because the total risk weights the risk for each operating state by the fraction of time the RTU spends in each state.

Table 5-2: Daily FTA Results by Operating State

Scenario	Normal Operation		Installation & Servicing w/Blower Off
	Blower Off	Blower On	
A	3.1	0	5.0
B	0.67	0	1.1
C	0.000084	0	0.23
D	0.000032	0	0.088
E	0.000017	0	0.053
F	0.0000066	0	0.020

Note: Multiply each value by 10⁻¹⁰ to yield the full daily risk value

5.2 Ignition Risk by Refrigerant

Risk of ignition for the two examined refrigerants – R-32 and R-1234yf – varies for three different reasons:

- R-1234yf has substantially higher minimum ignition energy (MIE) than does R-32, at 5,000 and 100 mJ, respectively.
- The two refrigerants have different flow characteristics and charges required for a specific cooling capacity (based on different specific heat capacities), causing each refrigerant to disperse differently and for flammable concentrations to remain for differing durations.
- The burning velocity for R-1234yf is significantly lower than that of R-32 (1.5 cm/s and 6.7 cm/s, respectively). Therefore the local velocity threshold above which refrigerant cannot ignite is substantially lower for R-1234yf than for R-32.

The effects of these differences on the location and duration of flammable concentrations were examined in the CFD analysis, and are discussed in section 4.3 above. The effects of difference in refrigerant burning velocity are discussed in section 4.4 above.

As shown in Table 5-1 above, the annual risk calculated for a leak of R-32 from an RTU serving a commercial kitchen is higher than that calculated for a leak of R-1234yf (from Scenarios A and B, respectively). Specifically, the risk for an R-32 leak is 4.5 times higher than that for an R-1234yf leak. The main driver of this difference in ignition risk is the difference in burning velocity between the two refrigerants, as discussed above. The risk of ignition in Scenarios A and B is largely driven by the probability of ignition of refrigerants that leaked into the conditioned space, where pilot lights on gas-powered cooking equipment would be present. For ignition from kitchen pilot lights, neither the different MIE values nor flammable concentration durations of R-1234yf had significant effects on the calculated risks. Pilot lights would have sufficient energy to ignite either refrigerant, rendering the difference in MIE values inconsequential. Because any such flammable concentration would lead to ignition, the duration of the presence of flammable concentration does not affect the ignition risk.

As discussed in section 3.3, we developed a factor to scale the risk of ignition of R-32 in Scenarios C and E to estimate the risk of ignition of R-1234yf in Scenarios D and F (Scenarios D and C differ only in refrigerant, and E and F also differ only in refrigerant). The ignition risks calculated for Scenarios A and B without gas pilot lights were 3.4×10^{-11} and 1.3×10^{-11} , respectively. The ratio between these calculated risks, 0.38, was then used to scale the ignition risks for Scenarios C and E to yield the calculated risks for Scenarios D and F shown in Table 5-1.

6. Conclusions

6.1 Risk Drivers

The risk drivers most associated with ignition in a commercial kitchen are as follows:

- Fast evaporator leak
- Blower not operating
- Gas pilot lights running continuously on cooking equipment
- Gas pilot light operating in close proximity to the return duct

The risk drivers most associated with ignition in an office from a leak in a roof-mounted or ground-mounted RTU are as follows:

- Leak resulting in flammable concentrations inside the RTU during installation (blower not operating)
- Brazing torch used by technician within RTU while flammable concentration is present

6.2 Overall Risk Findings

The majority of the region that develops a refrigerant concentration between the LFL and UFL is not flammable because the local velocity greatly exceeds the refrigerant burning velocity. Specifically, CFD results from Scenarios 1 (R-32) show that most of the modeled volume (including inside the RTU, surrounding the RTU, and inside the conditioned space) has local air velocities higher than 2.5 times the burning velocity, largely caused by the entrained air flow from the leak jet. Results from Scenario 2 (R-1234yf) did not show any monitoring points with a local velocity lower than this threshold. Instead of assuming that there was zero chance of the local velocity falling below this threshold for a leak of R-1234yf, we conservatively estimated the risk of falling below this velocity threshold by scaling the R-32 results, based on the ratio of burning velocities for each refrigerant. While this approach is the best available, it likely overestimates the ignition risk from leaks of R-1234yf.

The risk of ignition when the blower is operating is negligible, as shown in results from CFD Scenarios 3 and 10. This risk is negligible for two reasons:

- The airflow from the blower quickly disperses any refrigerant before a concentration between the LFL and UFL can develop
- The airflow from the blower causes a velocity much higher than the refrigerant burning velocity and therefore prevents ignition

The risk for ignition in the examined commercial kitchen scenarios are two to three orders of magnitude higher than the risks calculated for the office scenarios. Greater than 99% of the difference in ignition risk between the commercial kitchen and office scenarios is accounted for by the risk of ignition from pilot lights on commercial cooking equipment.

6.3 Operating State Impacts

For the office scenarios, the predicted risk during installation was several orders of magnitude higher than the risk during normal operation when the blower is off. For both a roof-mounted RTU (Scenarios C and D) and a ground-mounted RTU (Scenarios E and F) serving an office, the risk is over 2500 times

higher during installation than during normal operation when the blower is off. However, for the commercial kitchen scenarios (A and B), the ignition risk during installation is only 65% higher than the risk during normal operation when the blower is off.

This larger difference in risk between normal operation and installation for the office scenarios stems from our assumption that a brazing torch could be present inside or outside the RTU during installation or servicing with the blower off. A brazing torch presents a larger ignition risk than other ignition sources in the office scenarios. Because brazing would not be conducted during normal operation, the risk in this operating state is significantly lower than that during installation and servicing.

However, for the kitchen scenarios, gas pilot lights on cooking equipment present a larger ignition risk than any other ignition source, including a brazing torch. Therefore, the presence of a brazing torch during installation and servicing for an RTU serving a commercial kitchen does not significantly increase the risk of ignition. The risk is higher during installation because of higher probabilities of a leak occurring during installation than during normal operation with the blower off.

6.4 Leak Location Impacts

During normal operation, the risk of ignition is higher for a leak in the evaporator compartment than for a leak in the condenser compartment for all scenarios except an office served by a ground-mounted RTU, because ignition is more likely in the conditioned space than in the RTU or surrounding the RTU for these scenarios. The difference in risk between evaporator and condenser leaks is largest for the kitchen scenarios (A and B), because of the presence of gas pilot lights in the commercial kitchen, which could ignite flammable concentrations of refrigerant that stretch from the evaporator compartment to the conditioned space. In the office scenarios with a roof-mounted RTU (C and D), the ignition risk is higher for evaporator leaks than for condenser leaks because results from CFD Scenarios 1 and 6 show that the pool of leaked refrigerant would persist significantly longer for a leak to the conditioned space than for a leak to outside the RTU. In the office scenarios with a ground-mounted RTU (E and F), the ignition risk is higher for condenser leaks for several reasons. First, an office served by a ground-mounted RTU is the only analyzed conditioned space in which we did not analyze a cigarette lighter as a potential ignition source, because results from CFD scenarios 8 and 9 show that the pool of flammable concentrations would not rise above the floor (where a cigarette lighter would not be used). Our analysis shows that a cigarette lighter is much more likely to be present when a leak occurs than is a spark, therefore the exclusion of a cigarette lighter as a potential ignition source inside an office significantly decreases the ignition risk. Additionally, our leak frequency data shows a higher probability of a leak in the condenser compartment than in the evaporator compartment.

During installation, the risk for ignition is higher for evaporator leaks in kitchen scenarios (A and B), but is higher for condenser leaks in office scenarios (C-F). The risk is higher for condenser leaks during installation in the office scenarios because a brazing torch was considered as a potential ignition source during installation and is the most likely ignition source to cause ignition, and our leak frequency data show a higher probability of a leak in the condenser compartment than in the evaporator compartment.

6.5 Return Ducting Configuration Impacts for Ground-Mounted Units

The risk of ignition in the conditioned space is negligible for ground-mounted RTUs with a vertical return ducting configuration (i.e., where the return ducts comes from the top of the building, down to the ground mounted unit). CFD results from Scenario 7 show that leaked refrigerant does not reach the top of the return duct and therefore does not enter the conditioned space.

The risk of ignition in the conditioned space is higher for ground-mounted RTUs with a horizontal return ducting configuration, but the risk is significantly lower than the risk of ignition in the conditioned space in other scenarios. In this configuration (compared to a vertical ducting configuration), leaked refrigerant does not need to rise through the duct to reach the conditioned space, and the return duct is significantly shorter, providing less volume for the leaked refrigerant to occupy before reaching the conditioned space. However, CFD results from Scenarios 8 and 9 indicate that leaked refrigerant does not rise above the floor of the office. The only identified ignition source in the office served by a ground-mounted RTU with a horizontal return ducting configuration is a spark that might occur from appliances such as a computer or mini-fridge. As described above in section 6.4, the likelihood of a spark occurring in the conditioned space at the same time as a refrigerant leak is significantly lower than that for other ignition sources analyzed in other scenarios, such as a cigarette lighter or gas pilot flame.

6.6 Comparison to Known Risk Levels

Table 6-1 shows the risks predicted by the FTA in comparison to other safety hazard risks. The table includes the risks for each examined scenario, as well as the risks for six other activities. The risk of ignition for all of the scenarios is significantly lower than any of the identified risks for other activities.

Table 6-1: Safety Hazard Risk (Annual Frequency) Levels for Various Activities

Safety Hazard Risk	Risk
Fatal injury risk for worker in the mining, quarrying, and oil and gas extraction industry ⁶	1.2 E-4
Occupant fatality risk in traffic crash (per person in U.S.) ⁷	8.5 E-5
Fatal injury risk on the job for employed people in the U.S. ⁸	3.3 E-5
Non-occupant fatality risk in traffic crash (per person in U.S.) ⁹	1.8 E-5
Injury risk for park attendee on amusement park ride ¹⁰	4.7 E-6
Frequency of ignition in residential heat pump using R-32 ¹¹	3.7 E-6
Frequency of ignition in 100T chiller with unrestricted airflow using R-32 ¹²	8.3 E-7
Annual refrigerant ignition risk in scenario A	3.9 E-8
Annual refrigerant ignition risk in scenario B	8.5 E-9
Annual refrigerant ignition risk in scenario C	8.0 E-11
Annual refrigerant ignition risk in scenario D	3.0 E-11
Annual refrigerant ignition risk in scenario E	1.8 E-11
Annual refrigerant ignition risk in scenario F	7.0 E-12

Higher→

6.7 Mitigation Strategies

The results highlight several opportunities for risk mitigation that are listed below (in no particular order):

- **Compressor type** – Vibration from the compressor cycling on and off is considered one of the most likely drivers of a refrigerant leak. Use of compressors that minimize vibrations will reduce the ignition risk by reducing the leak risk.

⁶ <http://www.bls.gov/iif/oshwc/foi/cfch0013.pdf> reports 12.4 fatalities in the Mining, quarrying, and oil and gas extraction industry per 100,000 workers in 2013

⁷ <http://www-nrd.nhtsa.dot.gov/Pubs/812101.pdf> reports 27,051 occupant fatalities in 2013 with a population of 316.5 million.

⁸ www.bls.gov/iif/oshwc/foi/worker_memorial.htm reports 4,585 fatalities on the job in the U.S. in 2013 and 139,064,000 employed persons (from U.S. Census Bureau Table 620 from www.census.gov/compendia/statab/2012/tables/12s0620.pdf)

⁹ <http://www-nrd.nhtsa.dot.gov/Pubs/812101.pdf> reports 5,668 non-occupant fatalities in 2013 with a population of 316.5 million.

¹⁰ http://www.nsc.org/NSC/Documents_Corporate/Fixed-site-amusement-ride-injury-survey-2013-update.pdf reports 4.7 injuries per million attendances – also reported as 0.9 injuries per million patron rides.

¹¹ Goetzler, et. al., “Risk Assessment of HFC-32 and HFC-32/134a (30/70 wt. %) in Split System Residential Heat Pumps,” (1998); average of grand total frequencies across each region in Table 6-1. The table states that these data represent risk for a fire; however, the supporting text implies that these are the risk for ignition, not fire. Also these data do not include the effects of local velocity on ignition risk as was included in the analysis for this study. The ignition risk for refrigerant leaks from a residential heat pump would likely be significantly lower if these velocity effects were taken into account.

¹² Goetzler, et al., “Risk Assessment of Class 2L Refrigerants in Chiller Systems,” (2013). This previous analysis did not include the effects of local velocity on ignition risk as was included in the analysis for this study.

- **Multi-circuit RTUs** – By utilizing multiple circuits, manufacturers prevent total loss of refrigerant in the event of a leak. Multi-circuit RTUs reduce the probability of creating and maintaining a flammable concentration of refrigerant.
- **Self-diagnosis capabilities** – A refrigerant monitor, as typically applied in larger HVAC equipment (e.g., chillers), could detect if a significant concentration of refrigerant develops within the RTU, and signal to various other systems. Users can ensure greater reliability of refrigerant monitors through regular calibration and testing.
- **Air circulation** – If a refrigerant monitor detects a leak of refrigerant, the monitor could send a signal to the control system for the blower and condenser fan to operate. The fans should operate by default anytime a leak is suspected. Operation of the blower and/or condenser fan would help to quickly dissipate any leaked refrigerant.
- **Technician training** – The presence of technicians, both those working on the RTU, as well as any other personnel who may be working nearby, is a key concern, especially during installation and servicing. Enhanced training programs, including explicit training on flammable refrigerants will reduce human-error-induced risk.
- **Location and protection of ground-mounted RTUs** – A contributor to the increased probability of a leak for an RTU mounted on the ground instead of the roof is the potential for the RTU to be hit, either accidentally or intentionally. Potential causes of such contact include baseballs, lawn mowers, and vandals. Selection of a location for ground-mounted RTUs to minimize such contact could decrease the frequency of refrigerant leaks.
- **Pilot lights** – Replacing pilot lights on cooking appliances with electronic igniters (either the ignition module itself or the whole appliance) would significantly reduce the likelihood of ignition by removing the most probable ignition source in a commercial kitchen. FTA results for Scenarios A and B indicate that removal of pilot lights as a potential ignition source reduces the ignition risk by two to three orders of magnitude. As Table 4-6 above discusses, the blower, which would be operating any time the flames themselves (e.g., from a broiler) are present, will prevent the buildup of a flammable concentration of refrigerant. This upgrade has the added benefit of reducing energy consumption.

6.8 Future Work

This study provided valuable insights into the ignition risk of 2L refrigerants. The evaluation team identified two areas for future work which could lead to more detailed scientific understanding of the ignition risks, including:

- **Extended research on key risk probabilities:** In the high-risk branches of the fault trees, the FTA results could be refined through additional research on each input variable. The data we use in this study are the best currently available, but through additional interviews with subject matter experts and scientific study of FTA inputs, the FTA could be refined to reduce uncertainty. Specific areas for extended research include the following:
 - **Local air velocity effects** – the effect of local air velocity on ignition serves to significantly decrease the size of the area where a flammable concentration of leaked refrigerant could be ignited. To better classify these effects, more thorough CFD analysis

could be conducted to examine the variation in local air velocity, and more investigation could be done to refine the understanding of the local air velocity at which ignition can occur (and its relation to the burning velocity of the refrigerant). Specifically, additional laboratory testing could help verify the local air velocity above which refrigerant ignition is not possible. This factor has a significant impact on the calculation of probability of refrigerant ignition, and any further work to better characterize this parameter would therefore improve the accuracy of the FTA results.

- **Leak probabilities** – A significant portion of the risk of ignition is due to the likelihood of a leak occurring. In this study, we relied solely on data provided by the AHRI PMS. Additional research into probability of leaks occurring, including discussion with contractors and technicians, as well as discussion with manufacturers and examination of warranty records could further refine the analysis.
- **Sensitivity analysis:** Sensitivity analysis can provide insights into the improvements in risk that might be achieved using the mitigation strategies discussed in Section 6.7. In particular, sensitivity to likelihood of leaks occurring and refrigerant charge size would be helpful to gauge the potential impact of the corresponding identified mitigation strategies. Sensitivity analysis could also be used to increase understanding of the impact of specific input variables on ignition risk. This could help in identification of additional mitigation strategies, understanding of probability targets for future research and development, and recommendations for safer building codes.

Appendix A. Leak Data Calculations and Assumptions

A.1 Leak Data

Table 6-2 below shows the set of leak frequency data that was provided by the AHRI PMS. These leak-frequency data represent the total number of leaks in the population divided by the size of the population. The team assumed that these leak frequency data could be applied as representative of the leak potential of any single RTU installed and operated over a one-year period.

Table 6-2: Leak Estimates Provided by the AHRI 8016 PMS

Operating State	5T RTU	15T RTU	25T RTU
	5T Circuit	10T Circuit	12.5T Circuit
Normal Operation	0.01	0.01	0.01
Installation	0.006	0.004	0.004

Table 6-3, Table 6-4, and Table 6-5 show the complete set of leak frequency data used in the FTA. These leak data are based on the estimates provided by the AHRI PMS that are shown above in Table 6-2 as well as the assumptions described below in section A.2.

Table 6-3: Leak Data for a 15T Roof-Mounted RTU Serving a Commercial Kitchen

Compartment	Leak Rate	Operating State		
		Normal Operation		Installation/Serviceing with Blower Off
		Blower Off	Blower On	
Condenser	Fast	9.4 E-5	0.00028	0.00015
	Slow	0.0018	0.0053	0.0029
Evaporator	Fast	3.1 E-5	9.4 E-5	5.0 E-5
	Slow	0.00059	0.0018	0.00095

Note: The same probabilities are used for both the 10T circuit and 5T circuit; however, each circuit is modeled separately in the FTA.

Table 6-4: Leak Data for a 25T Roof-Mounted RTU Serving an Office

Compartment	Leak Rate	Operating State		
		Normal Operation		Installation/Serviceing with Blower Off
		Blower Off	Blower On	
Condenser	Fast	0.00019	0.00056	0.00030
	Slow	0.0036	0.011	0.0057
Evaporator	Fast	6.2 E-5	0.00019	0.00010
	Slow	0.0012	0.0036	0.0019

Note: These probabilities are for both 12.5T circuits contained within the 25T RTU, so the leak probabilities listed above account for all leaks in the RTU.

Table 6-5: Leak Data for a 5T Ground-Mounted RTU Serving an Office

Compartment	Leak Rate	Operating State		
		Normal Operation		Installation/Serviceing with Blower Off
		Blower Off	Blower On	
Condenser	Fast	9.4 E-5	0.00028	0.00023
	Slow	0.0018	0.0053	0.0043
Evaporator	Fast	3.1 E-5	9.4 E-5	7.5 E-5
	Slow	0.00059	0.0018	0.0014

Note: These probabilities are for a single 5T circuit, because we analyzed a single-circuit design for a 5T RTU.

A.2 Assumption for Leak Data Calculations

The following assumptions were used to calculate the leak data used in the FTA from leak data for chillers in the AHRI 8005 project.

Table 6-6: Assumptions used for Calculation of Leak Data

Parameter	Value
Fraction of leaks that are fast	5%
Fraction of leaks during normal operation that occur with blower on	75%
Fraction of leaks that occur in condenser compartment (vs. evaporator compartment)	75%

Appendix B. CFD Model Assumptions and Inputs

B.1 Refrigerant Properties

Table 6-7: Refrigerant Properties

Parameters	Units	R-32	R-1234yf	R-1234ze
Molecular weight		52	114	114
Vapor density	kg/m ³ at 21 °C	42.1	33.8	23.3
Vapor pressure	MPa at 21 °C	1.52	0.61	0.44
Condenser Pressure at 45 °C	MPa	2.79	1.15	0.88
Evaporator Pressure at 5 °C (AC)	MPa	0.95	0.37	0.26
Evaporator Pressure at -10 °C (Ref)	MPa	0.58	0.22	0.15
Lower flammability limit	% in air (kg/m ³) @ 21 °C	14.4 (0.307)	6.2 (0.299)	N/A
Upper flammability limit	% in air (kg/m ³) @ 21 °C	29.3 (0.625)	12.3 (0.593)	N/A
Minimum Ignition Energy (MIE)	mJ	30	5,000	N/A
Heat of combustion	MJ/kg	9.4	10.7	N/A
Burning velocity	cm/s	6.7	1.5	0
Specific heat (C _p) vapor	kJ/kg-K at 21 °C	1.53	1.03	0.96
Vapor Viscosity	Pa-s at 21 °C	1.26	1.21	1.21
Diffusion coefficient in air	m ² /s	1.4 E-5 @ 20 °C	9 E-6 @ 20 °C	9 E-6 @ 20 °C
Ratio of specific heats - vap	21 °C	1.63	1.19	1.16

B.2 Assumed Equipment Operating Parameters

The assumed operating parameters below are based on characteristics of representative equipment for each size. It is important to note that for CFD scenarios in which the blower is off, it was assumed that the entire RTU would be off, and therefore the pressure in the air conditioning system would equalize. Hence, we have modeled those scenarios at their equilibrium pressures, rather than operating pressures.

Table 6-8: Assumed Equipment Operating Parameters

Parameters	Units	25 Ton	15 Ton	5 Ton
Average Air Flow Rates	CFM	9,000	5,500	2,000
Minimum Air Flow Rates	CFM	3,000	3,000	1,600
Maximum Air Flow Rates	CFM	15,000	8,000	2,400
Slow Leak – Hole Size	-	Pinhole Leak (for all RTU sizes)		
Fast Leak – Hole Size	mm	10	10	5
Refrigerant Charge: R-32*	Lbs	23 (12.5T Circuit)	12 (10T Circuit) 7 (5T Circuit)	7 (5T Circuit)
Refrigerant Charge: R-1234yf*	Lbs	32 (12.5T Circuit)	17 (10T Circuit) 10 (5T Circuit)	10 (5T Circuit)

Parameters	Units	25 Ton	15 Ton	5 Ton
Pressures (Condenser/Evaporator): R-32	PSI	473 / 148 (for all RTU sizes)		
Pressures (Condenser/Evaporator): R-1234yf	PSI	197 / 58 (for all RTU sizes)		
Temperatures (Condenser/Evaporator): R-32	°F	125 / 45 (for all RTU sizes)		
Temperatures (Condenser/Evaporator): R-1234yf	°F	125 / 45 (for all RTU sizes)		

*Calculated assuming drop-in replacement of HFC-410A requires the system to deliver the same capacity under the same approach temperature.

B.3 CFD Scenario Assumptions

In order to obtain reliable results without an unreasonably long simulation time, several assumptions were made for the CFD modeling and are listed below.

- No air exchange between interior of RTU and surrounding air for all scenarios except Scenario 6
- For Scenario 6, a low wind speed of 1 m/s (5th percentile) was simulated, providing a worst-case scenario. Higher wind speeds would lead to much more rapid dissipation of leaked refrigerant. However, the team notes that 1 m/s wind speed already leads to local air velocities much greater than 2.5 times the refrigerant burning velocity, meaning that refrigerant ignition is not possible.

B.4 Modeled CFD Geometry Diagrams

The following diagrams show the modeled geometries used in the CFD analysis. These include geometries of the inside of RTUs, ventilation systems, and conditioned spaces (commercial kitchen or office).

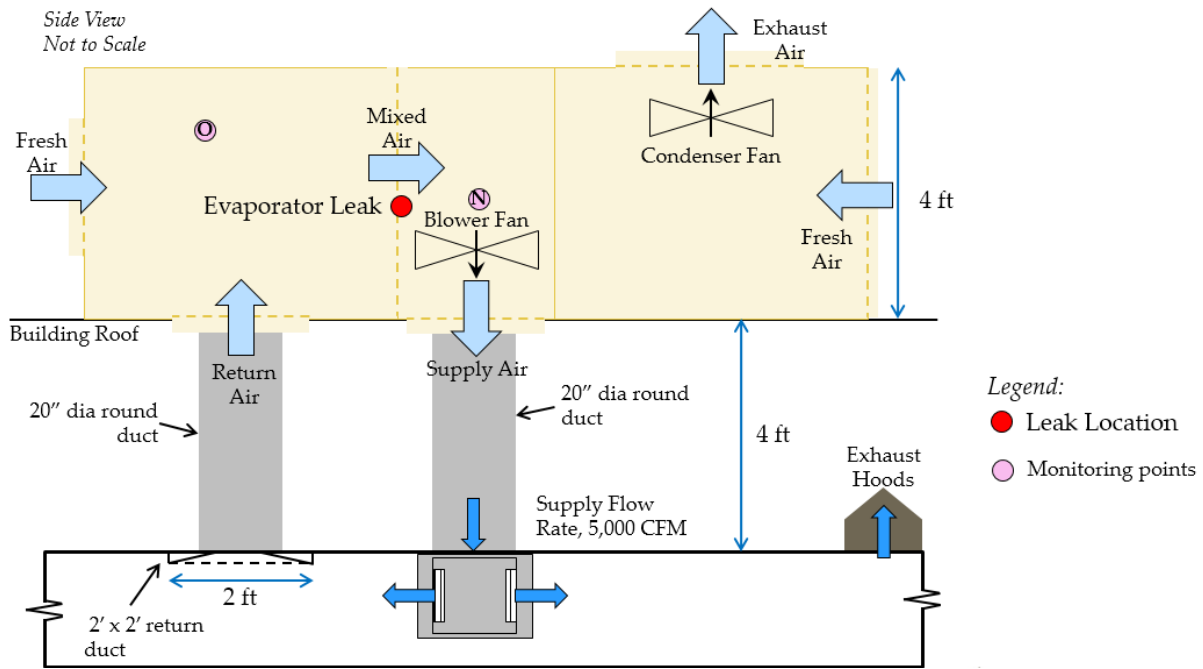

Figure 6.1: Modeled Geometry of 15T RTU Serving a Commercial Kitchen, Side View

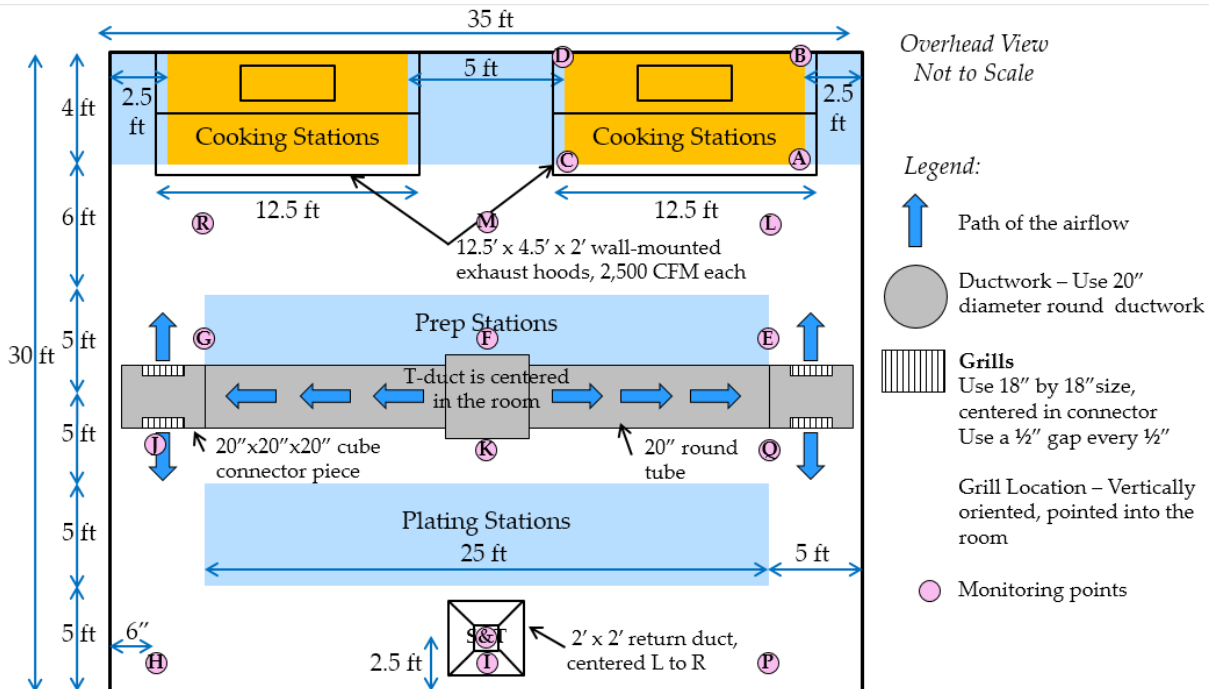

Figure 6.2: Layout of a Commercial Kitchen Served by a 15T RTU, Overhead View

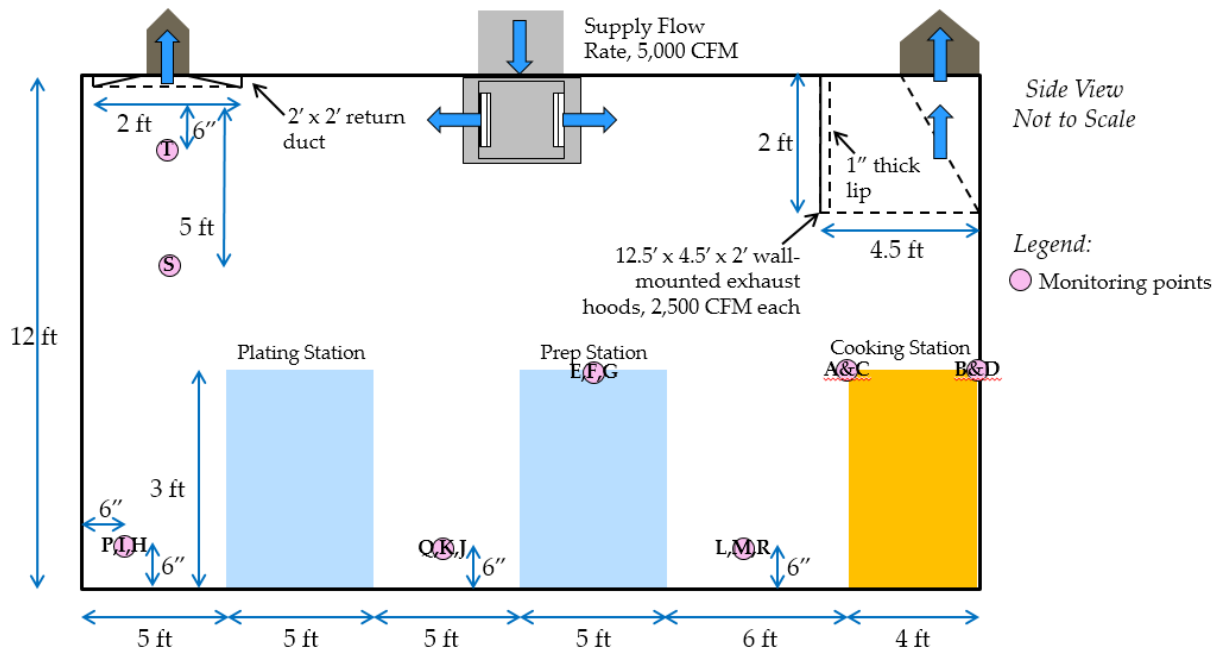

Figure 6.3: Layout of a Commercial Kitchen Served by a 15T RTU, Side View

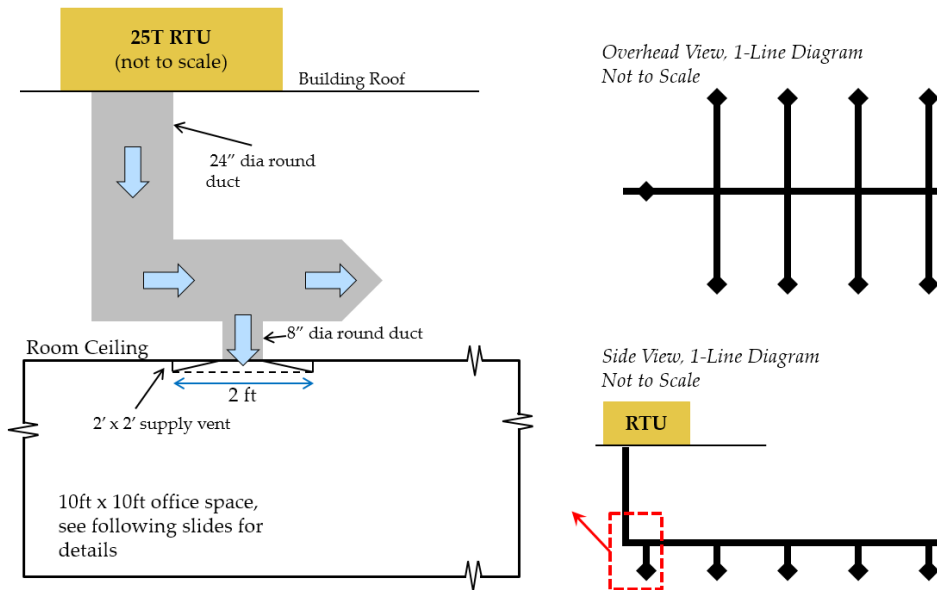

Figure 6.4: Modeled Geometry for an Office Served by a 25T RTU, Side View

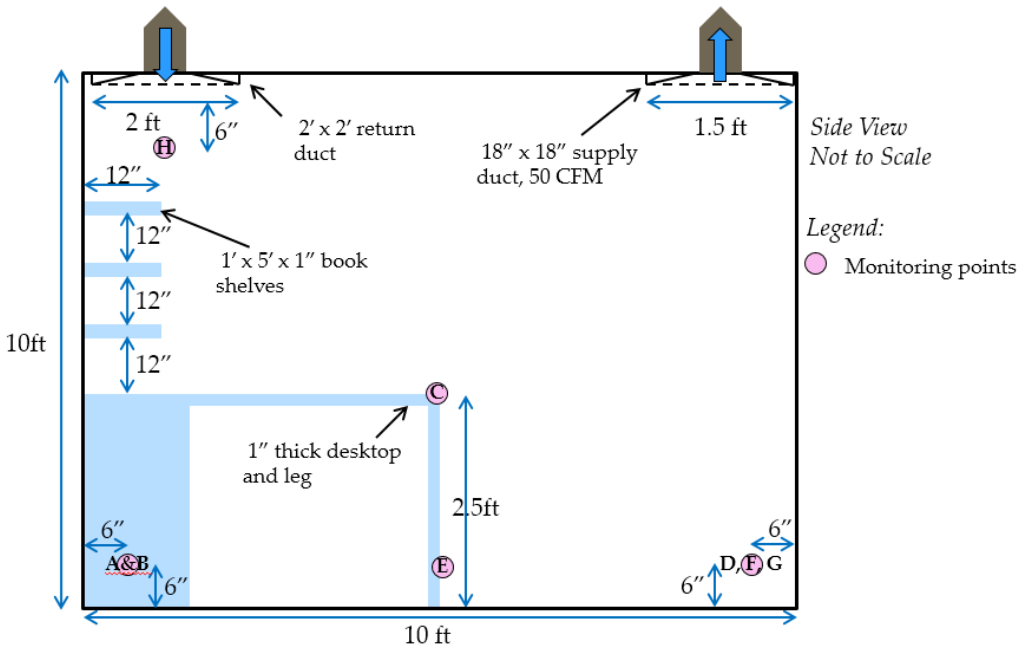

Figure 6.5: Layout of an Office Served by a 25T RTU, Side View

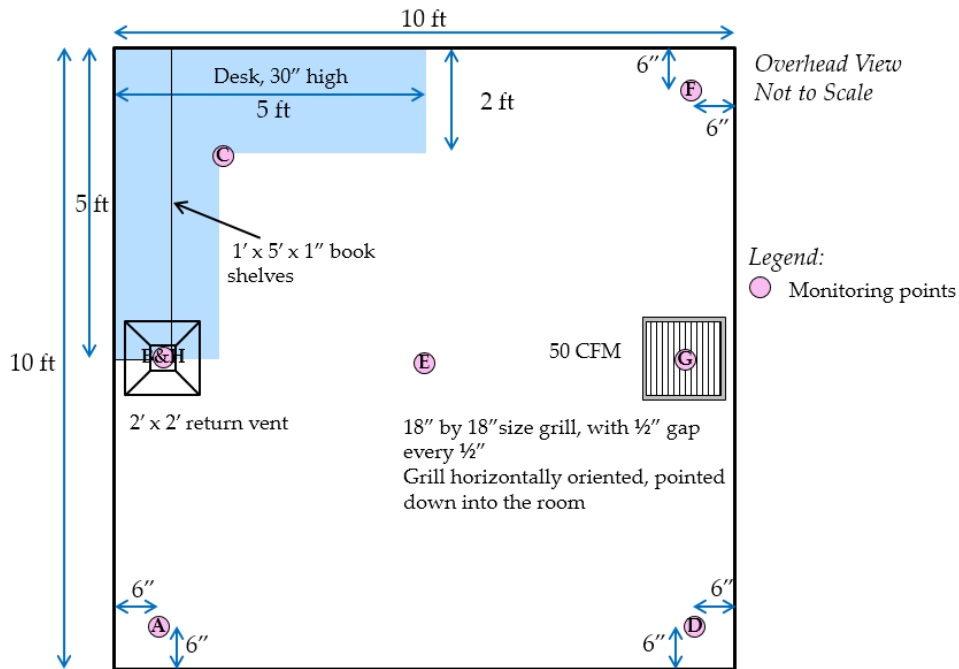

Figure 6.6: Layout of an Office Served by a 25T RTU, Overhead View

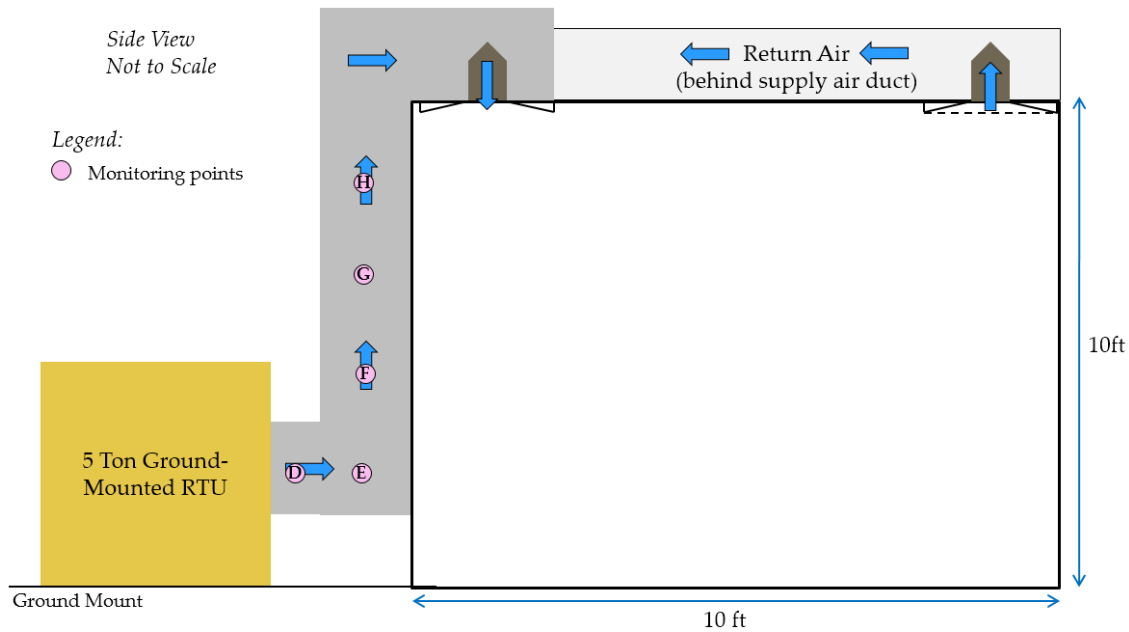

Figure 6.7: Modeled Geometry for an Office Served by a Ground-Mounted 5T RTU with Vertical Return Ducting, Side View

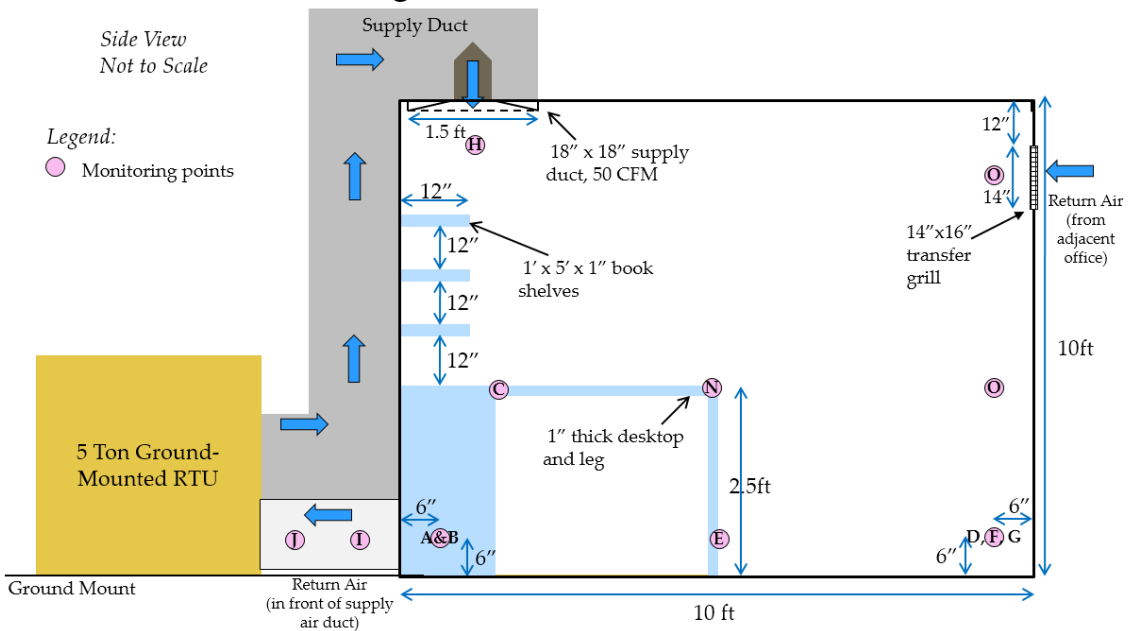

Figure 6.8: Modeled Geometry for an Office Served by a Ground-Mounted 5T RTU with Horizontal Return Ducting, Side View

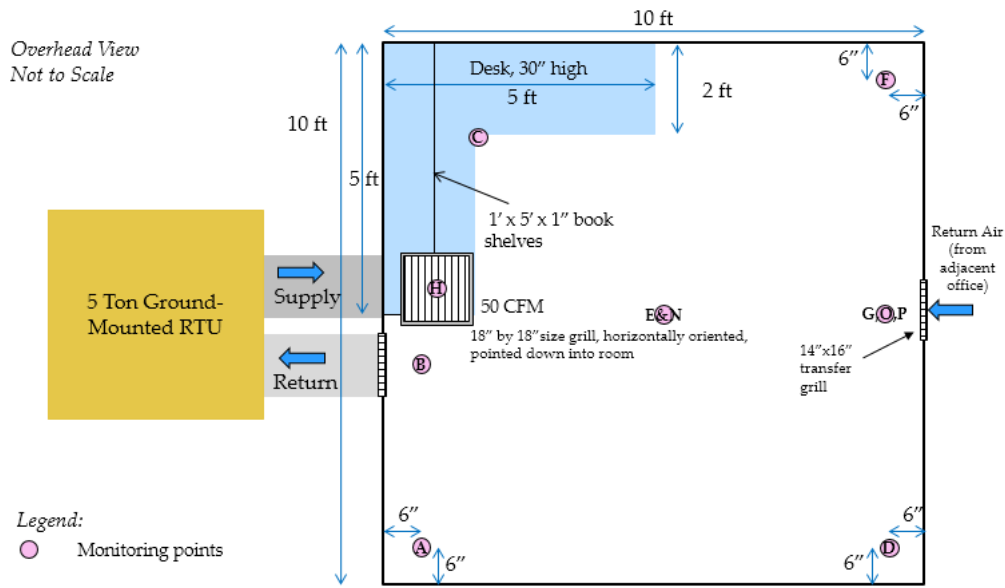

Figure 6.9: Modeled Geometry for an Office Served by a Ground-Mounted 5T RTU with Horizontal Return Ducting, Overhead View

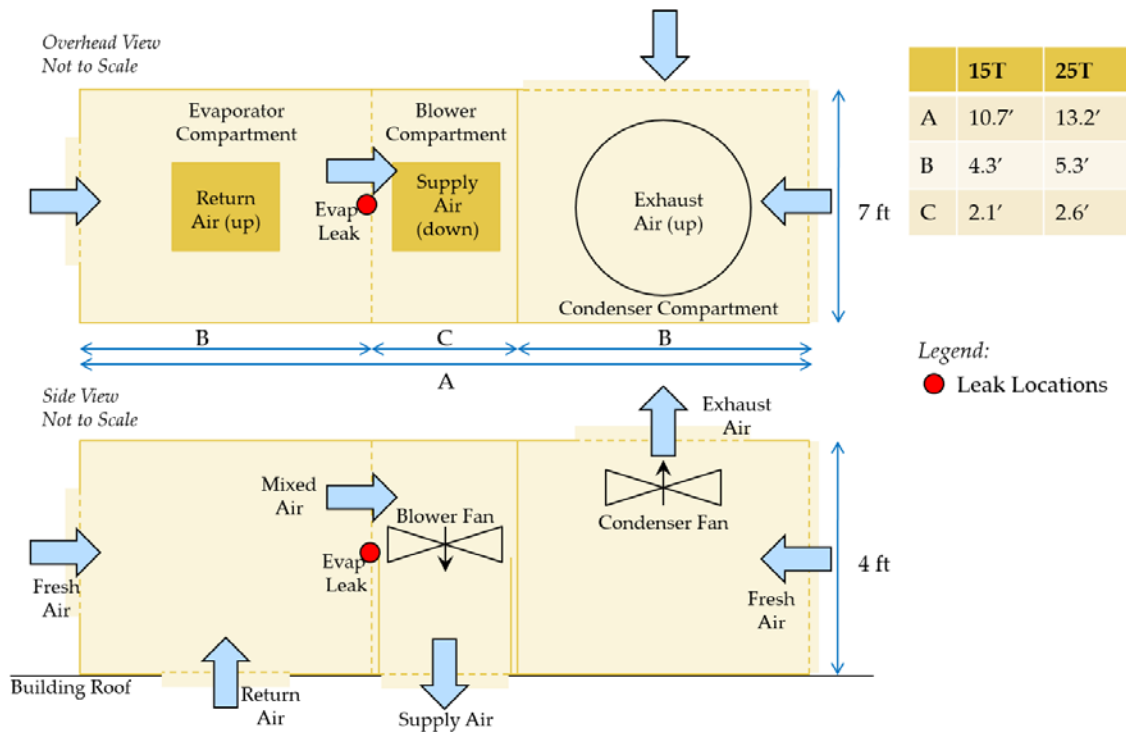

Figure 6.10: Modeled Geometry of 15T and 25T RTUs

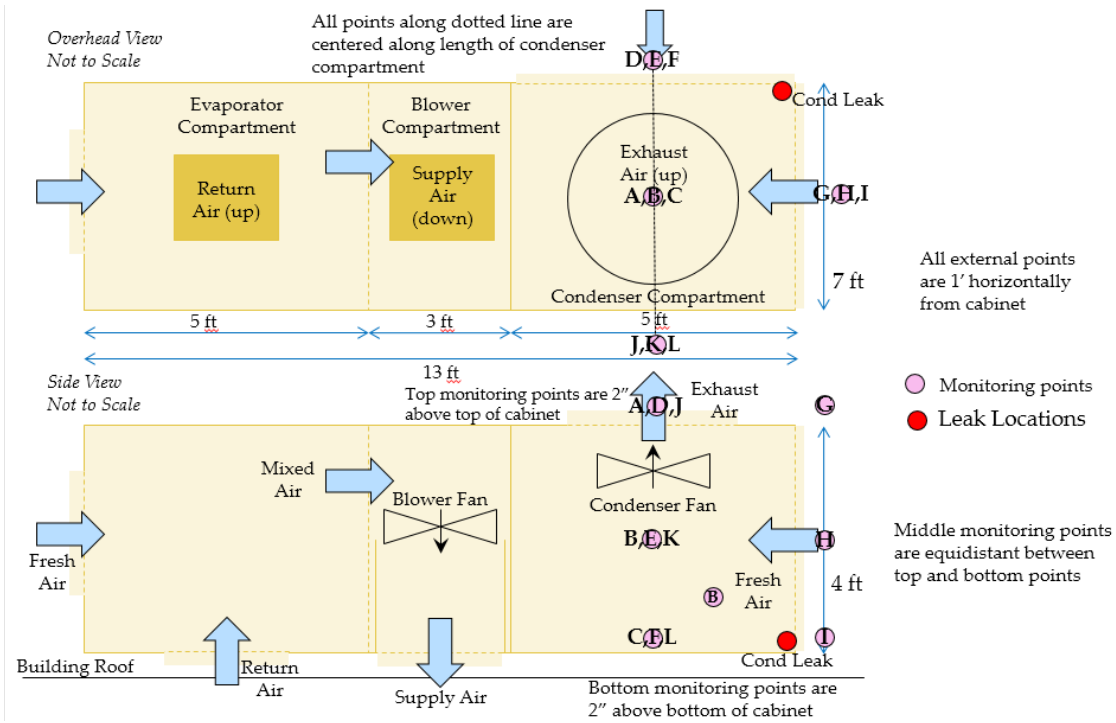

Figure 6.11: Modeled Geometry for Condenser Leak in 25T Roof-Mounted RTU Serving an Office

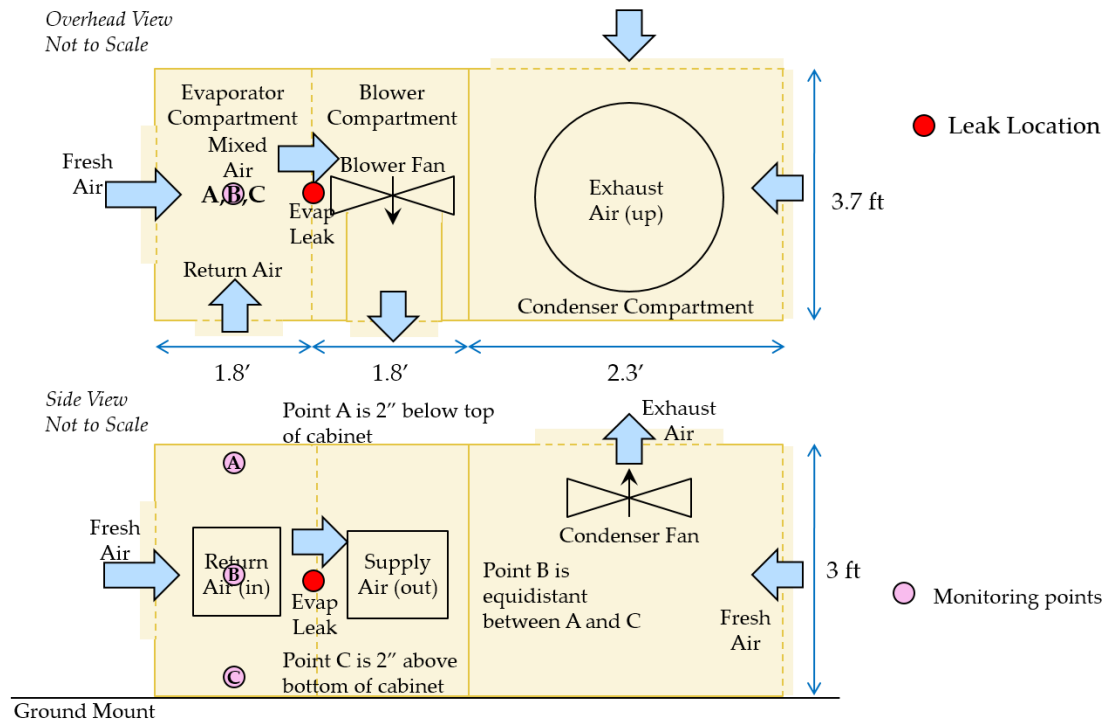

Figure 6.12: Modeled Geometry for 5T RTU Serving an Office

B.5 Monitoring Points for CFD Analysis

The following diagrams show the monitoring points used for each scenario modeled in the CFD analysis. Data including velocity and refrigerant concentration were profiled at each monitoring point over time, and results are shown in Appendices D and E.

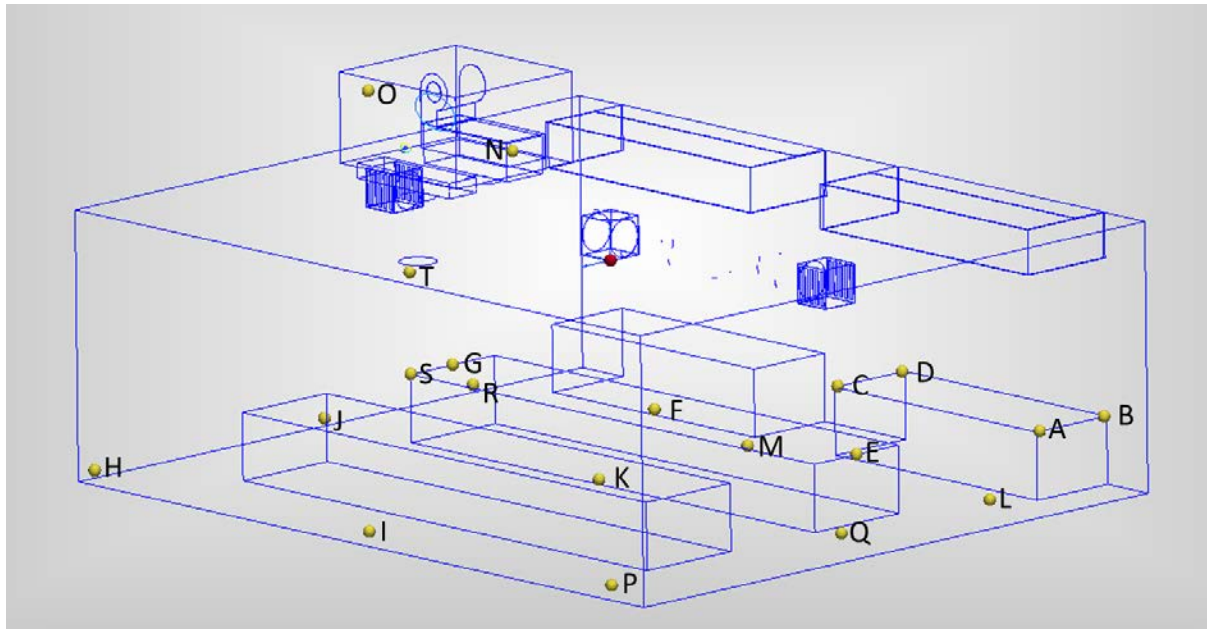

Figure 6.13: Modeled Geometry and Monitoring Points for Scenarios 1, 2, 3, and 10

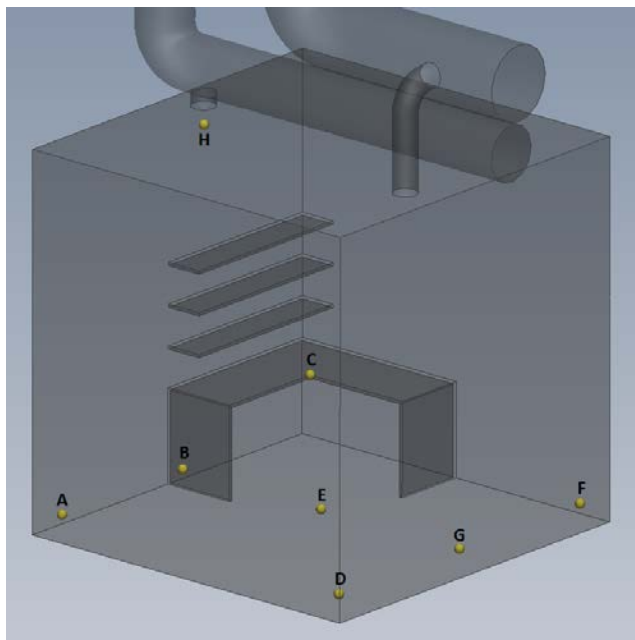

Figure 6.14: Modeled Geometry and Monitoring Points for Scenarios 4 and 5

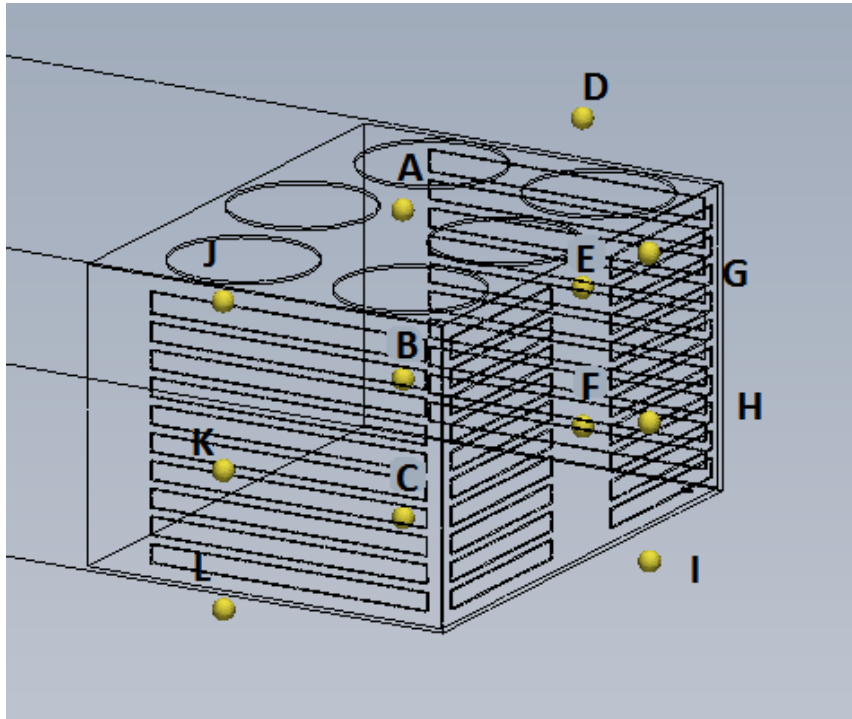

Figure 6.15: Modeled Geometry and Monitoring Points for Scenario 6

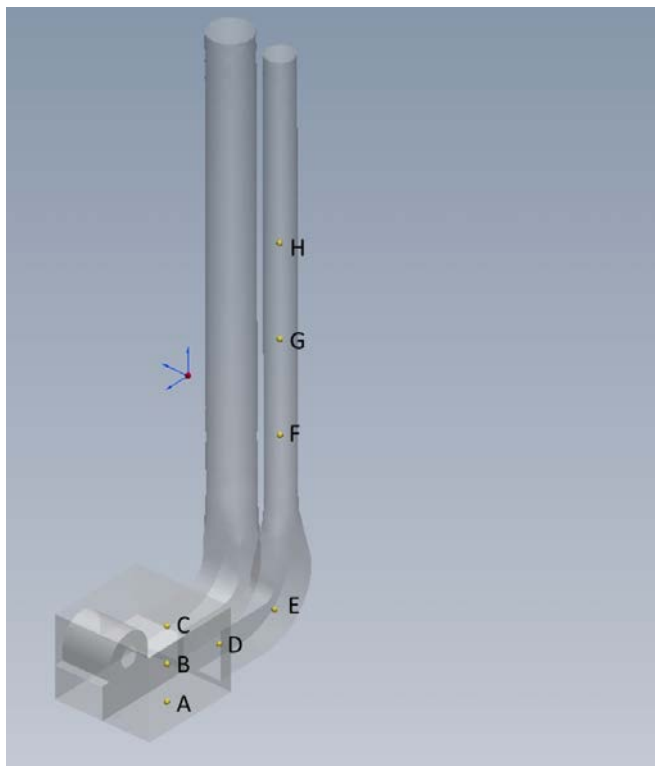

Figure 6.16: Modeled Geometry and Monitoring Points for Scenario 7

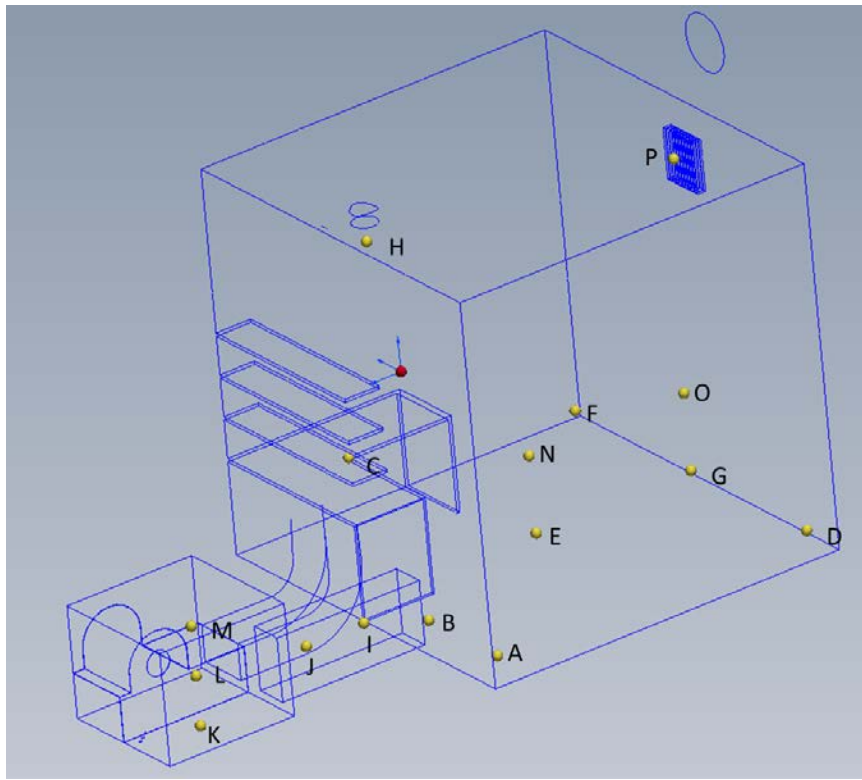

Figure 6.17: Modeled Geometry and Monitoring Points for Scenarios 8 and 9

Appendix C. CFD Leak Rate Plots

The following plots show the refrigerant leak rate profile over the course of the leak for each modeled CFD scenario. For each scenario, we assumed the refrigerant was in a gaseous state with pressure equalized across the circuit. We modeled a decaying pressure and associated leak rate, as developed for ASHRAE 1580.

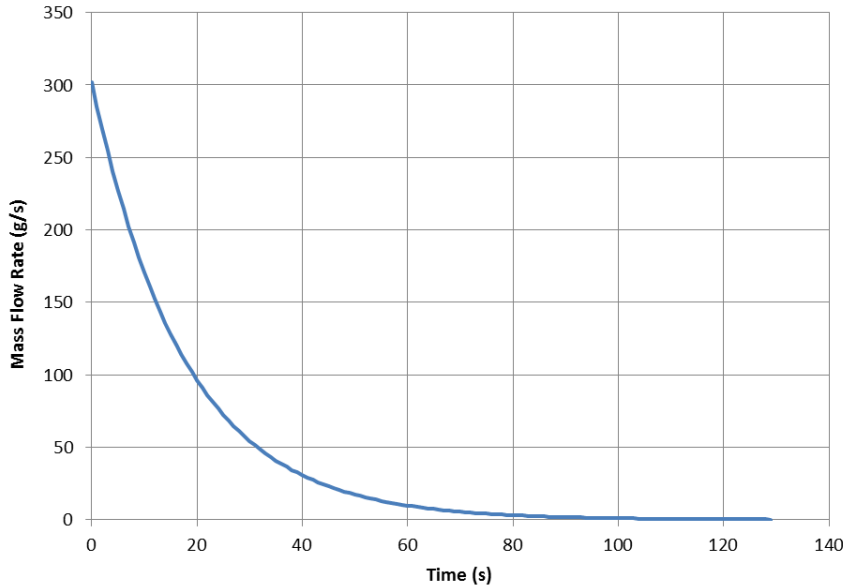

Figure 6.18: Leak rate versus time for Scenarios 1 and 3 – Fast evaporator leaks of R-32 from a 15T roof-mounted RTU serving a commercial kitchen

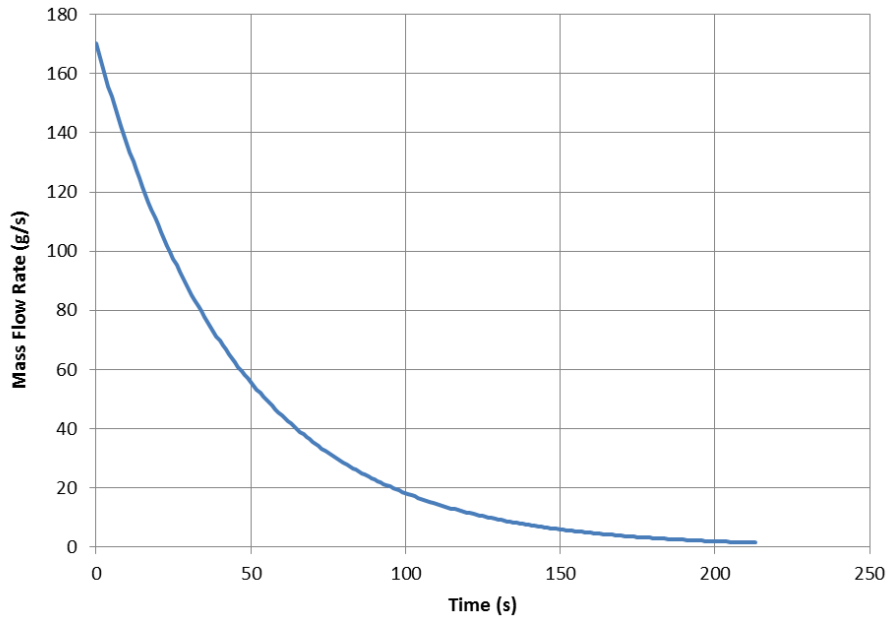

Figure 6.19: Leak rate versus time for Scenarios 2 and 10 – Fast evaporator leaks of R-1234yf from a 15T roof-mounted RTU serving a commercial kitchen

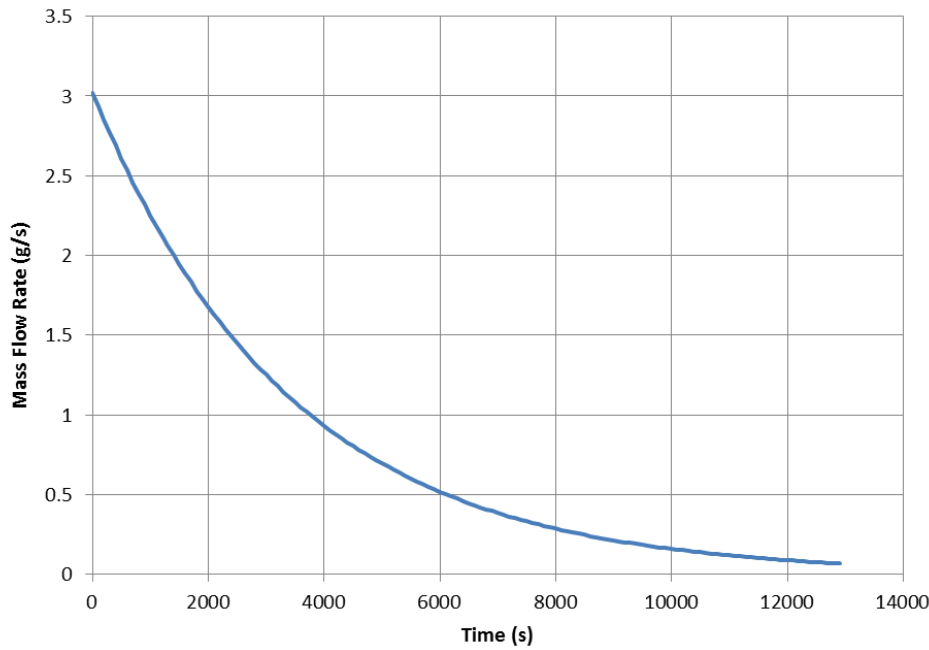

Figure 6.20: Leak rate versus time for Scenario 4 – Slow evaporator leak of R-32 from a 25T roof-mounted RTU serving an office

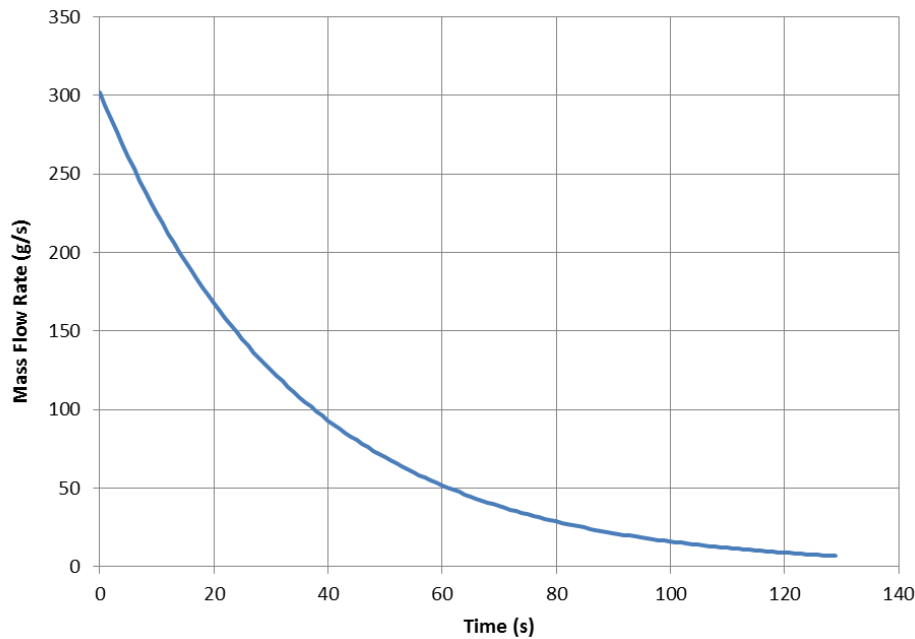

Figure 6.21: Leak rate versus time for Scenarios 5 and 6 – Fast evaporator and condenser leaks of R-32 from a 25T roof-mounted RTU serving an office

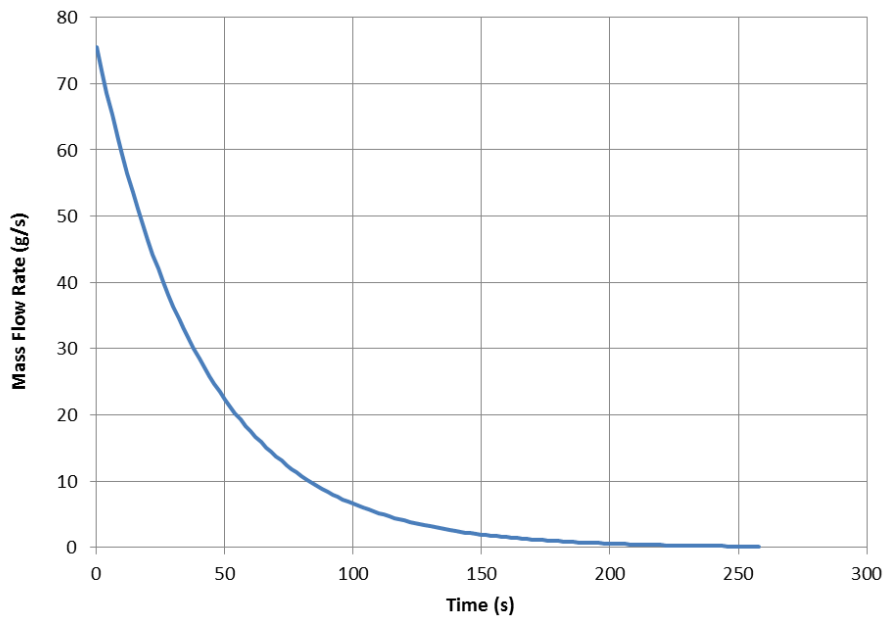

Figure 6.22: Leak rate versus time for Scenarios 7 and 8 – Fast evaporator leaks of R-32 from a 5T ground-mounted RTU serving an office

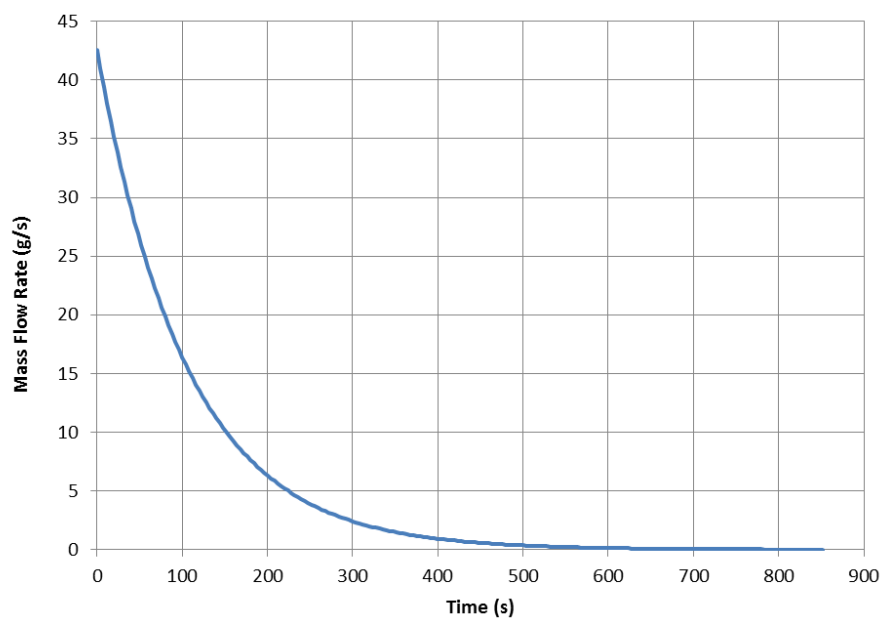

Figure 6.23: Leak rate versus time for Scenario 9 – Fast evaporator leak of R-1234yf from a 5T ground-mounted RTU serving an office

Appendix D. CFD Results Summary Tables

The following tables show a summary of results for each modeled CFD scenario. The plots show profiles of the refrigerant concentration over time at various monitoring points. Appendix B.5 above includes images that detail the locations of monitoring points within the modeled domain for each scenario.

Legend:

● - Substantial Flammable Plume ◐ - Small Flammable Plume ○ - No flammable Plume

#	Equipment Type	Ref.	Location	Leak Type	Leak Location /Condition	Model Boundaries	Notes
1	15T on rooftop	R-32	Comm. Kitchen	Fast	Evaporator – Blower off	RTU, ducting and kitchen space	Exhaust hoods off
Leak Duration:		25% Leaked		50% Leaked		90% Leaked	
		5 Sec		12 Sec		40 Sec	
Flammability and Duration of Flammable Plume within each Region:			Inside the RTU/Ventilation		In Conditioned Space		Outside the RTU
			●	2 Min	◐	2 Min	○

Concentration Plots at each Monitoring Point:

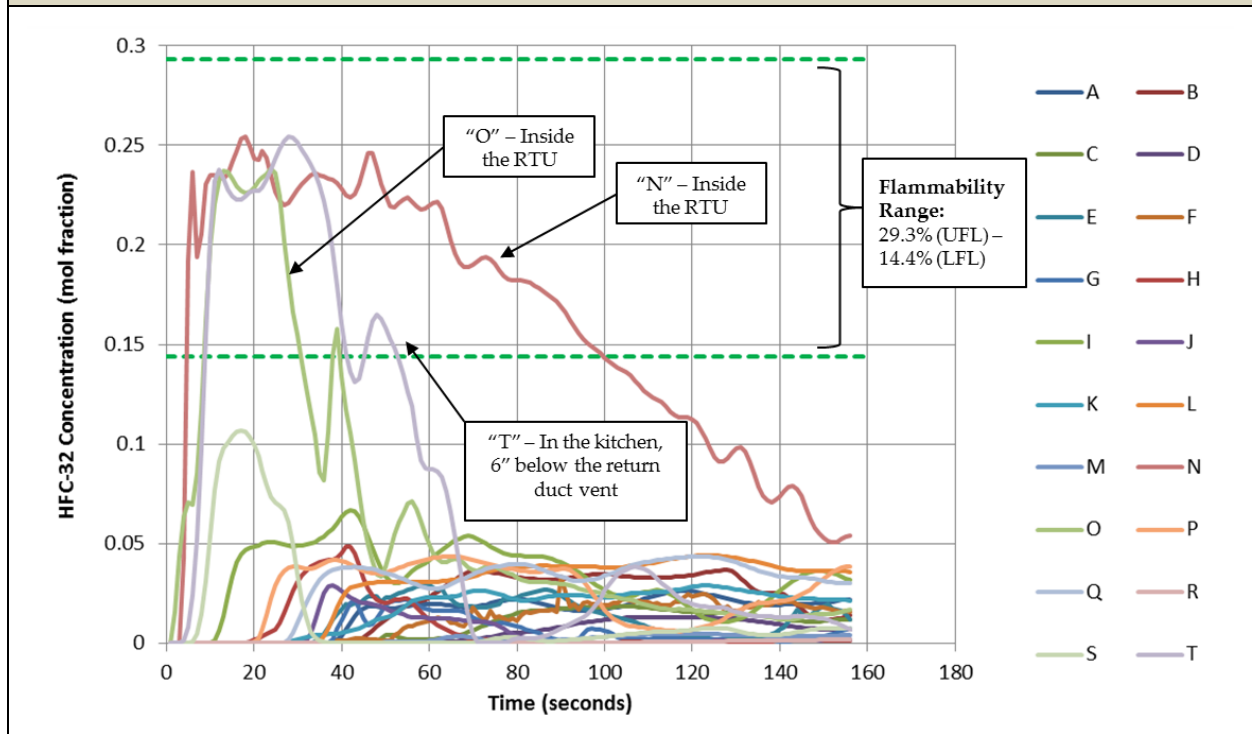

#	Equipment Type	Ref.	Location	Leak Type	Leak Location /Condition	Model Boundaries	Notes
2	15T on rooftop	R-1234yf	Comm. Kitchen	Fast	Evaporator – Blower off	RTU, ducting and kitchen space	Exhaust hoods off
Leak Duration:		25% Leaked		50% Leaked		90% Leaked	
		13 Sec		31 Sec		103 Sec	
Flammability and Duration of Flammable Plume within each Region:			Inside the RTU/Ventilation		In Conditioned Space		Outside the RTU
			●	150 Sec	◐	150 Sec	○

Concentration Plots at Each Monitoring Point:

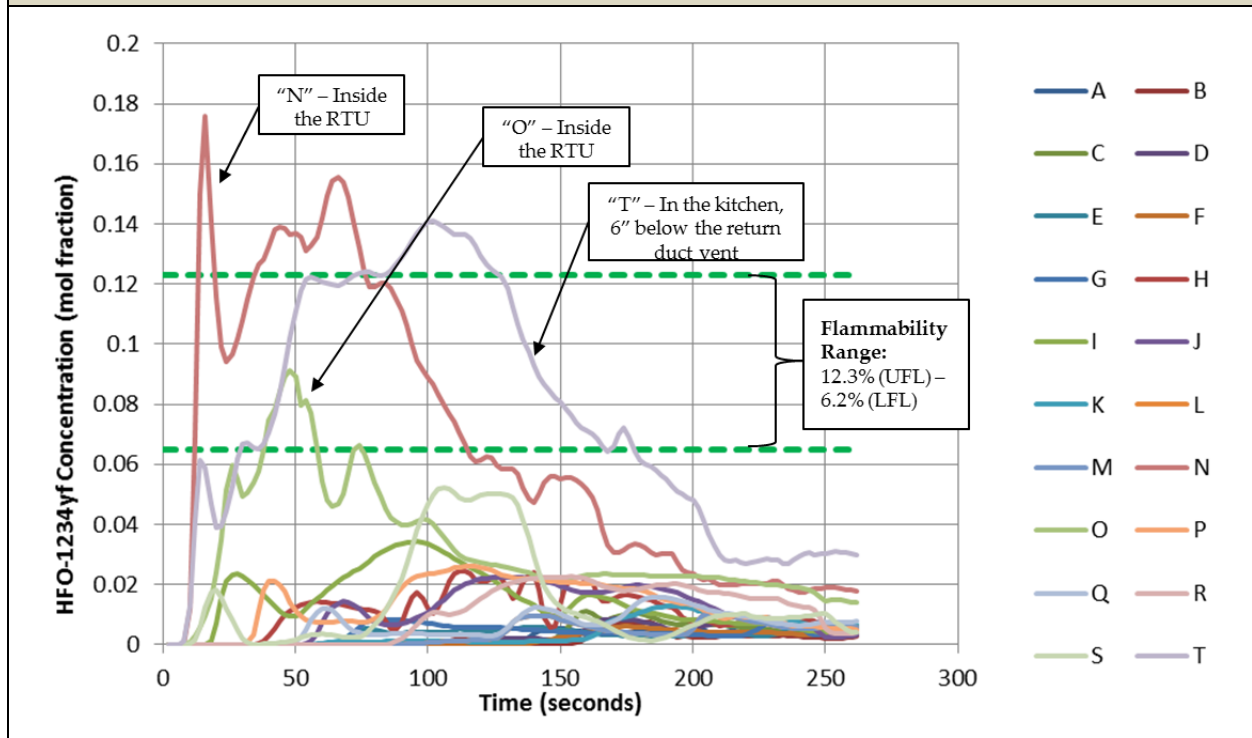

#	Equipment Type	Ref.	Location	Leak Type	Leak Location /Condition	Model Boundaries	Notes
3	15T on rooftop	R-32	Comm. Kitchen	Fast	Evaporator – Blower on	RTU, ducting and kitchen space	Exhaust hoods off
Leak Duration:		25% Leaked		50% Leaked		90% Leaked	
		5 Sec		12 Sec		40 Sec	
Flammability Within each Region:		Inside the RTU/Ventilation			In Conditioned Space		Outside the RTU
		●			○		○

Concentration Plots at Each Monitoring Point:

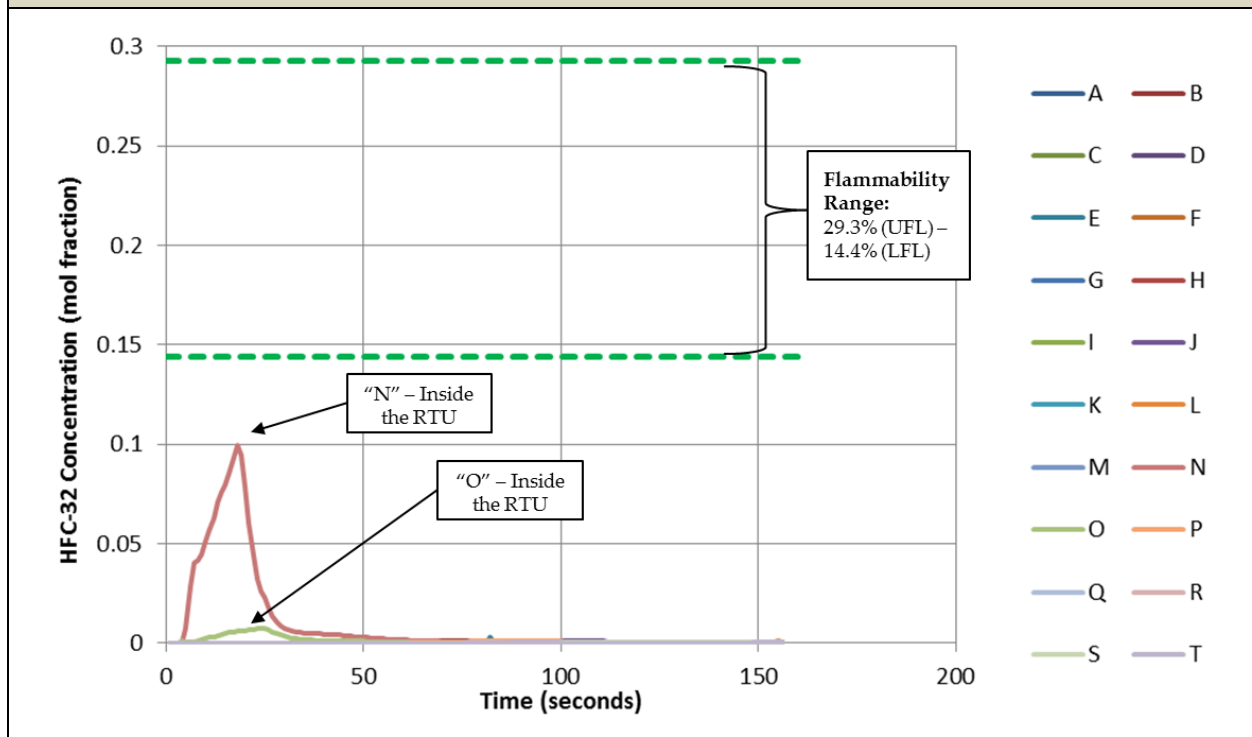

#	Equipment Type	Ref.	Location	Leak Type	Leak Location /Condition	Model Boundaries	Notes
4	25T on rooftop	R-32	Office	Slow	Evaporator – Blower off	RTU, ducting and kitchen space	
Leak Duration:		25% Leaked		50% Leaked		90% Leaked^a	
		15 Min		40 Min		-	
Flammability and Duration of Flammable Plume within each Region:			Inside the RTU/Ventilation		In Conditioned Space		Outside the RTU
			 2 Hours				

Concentration Plots at Each Monitoring Point:

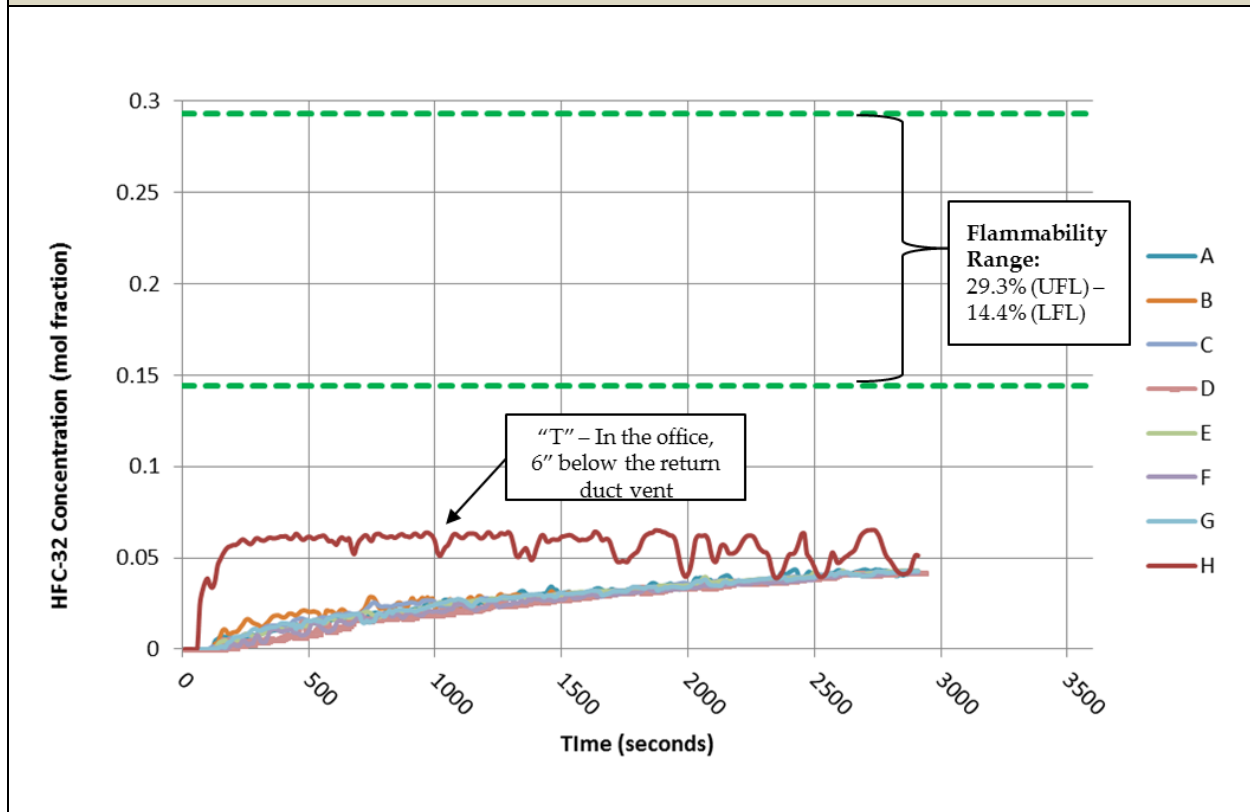

^a The simulation was stopped at 2900 sec (59% leaked) to reduce computation time. However, the monitoring point concentrations can be easily extrapolated to the end of the leak, as shown in the plot above.

#	Equipment Type	Ref.	Location	Leak Type	Leak Location /Condition	Model Boundaries	Notes
5	25T on rooftop	R-32	Office	Fast	Evaporator – Blower off	RTU, ducting and kitchen space	
Leak Duration:		25% Leaked		50% Leaked		90% Leaked	
		10 Sec		24 Sec		76 Sec	
Flammability and Duration of Flammable Plume within each Region:			Inside the RTU/Ventilation		In Conditioned Space		Outside the RTU
			●	5 Min	◐	4 Min	○

Concentration Plots at Each Monitoring Point:

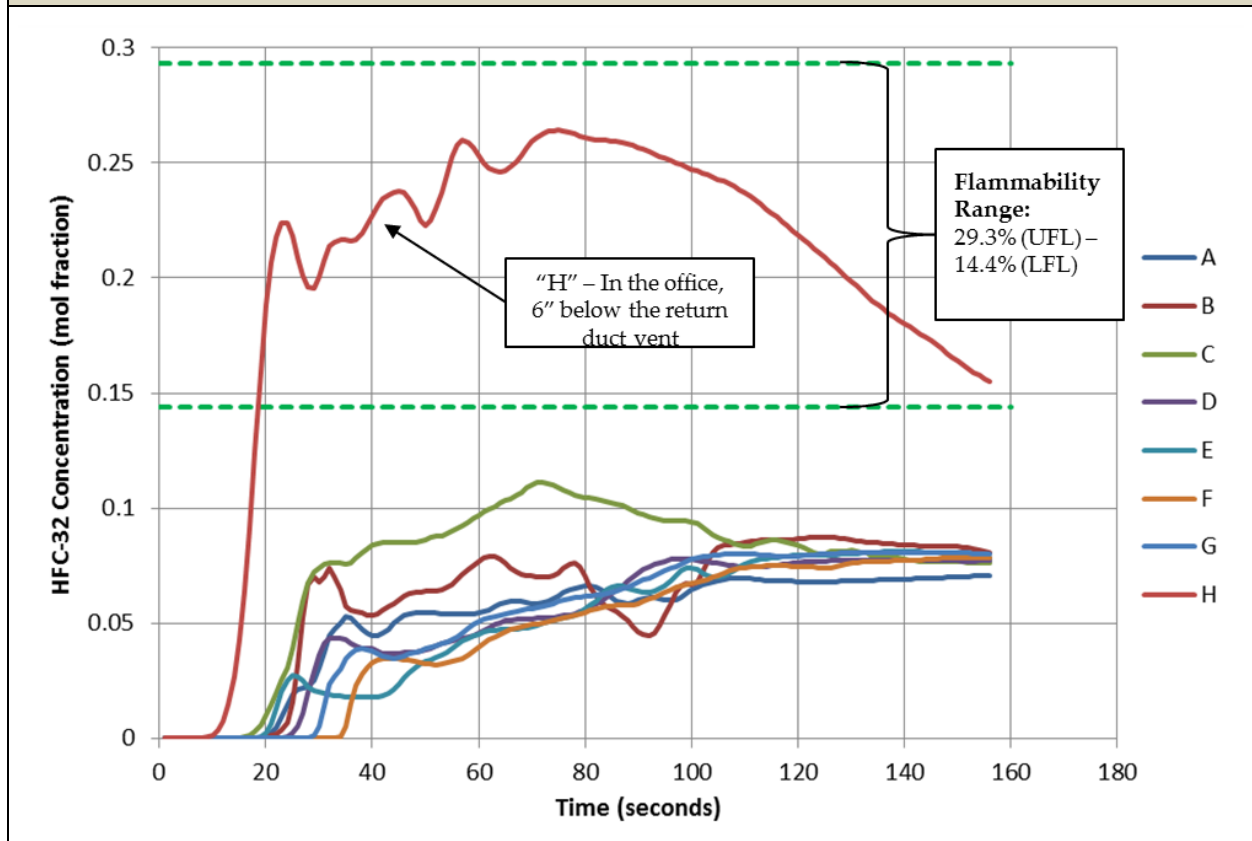

#	Equipment Type	Ref.	Location	Leak Type	Leak Location /Condition	Model Boundaries	Notes	
6	25T on rooftop	R-32	Office	Fast	Condenser – Condenser fan off	RTU, ducting and surrounding space		
Leak Duration:		25% Leaked		50% Leaked		90% Leaked		
		10 Sec		24 Sec		76 Sec		
Flammability and Duration of Flammable Plume within each Region:			Inside the RTU/Ventilation		In Conditioned Space		Outside the RTU	
			●	60 Sec	○	●	40 Sec	

Concentration Plots at Each Monitoring Point:

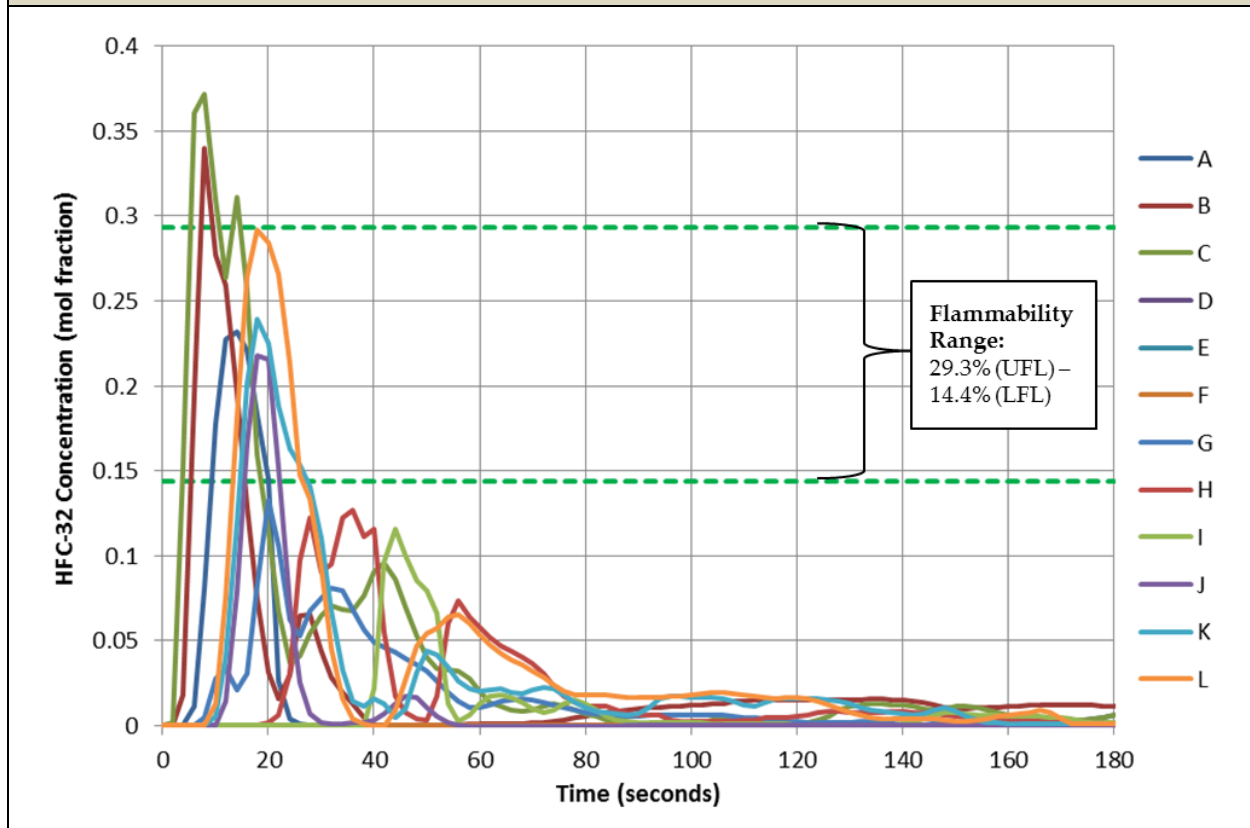

#	Equipment Type	Ref.	Location	Leak Type	Leak Location /Condition	Model Boundaries	Notes
7	5T on ground	R-32	Office	Fast	Evaporator – Blower off	RTU, ducting, and office space	Vertical return duct
Leak Duration:		25% Leaked		50% Leaked		90% Leaked	
		12 Sec		28 Sec		94 Sec	
Flammability and Duration of Flammable Plume within each Region:			Inside the RTU/Ventilation		In Conditioned Space		Outside the RTU
			● Until Dissipation ^a		○		○

Concentration Plots at Each Monitoring Point:

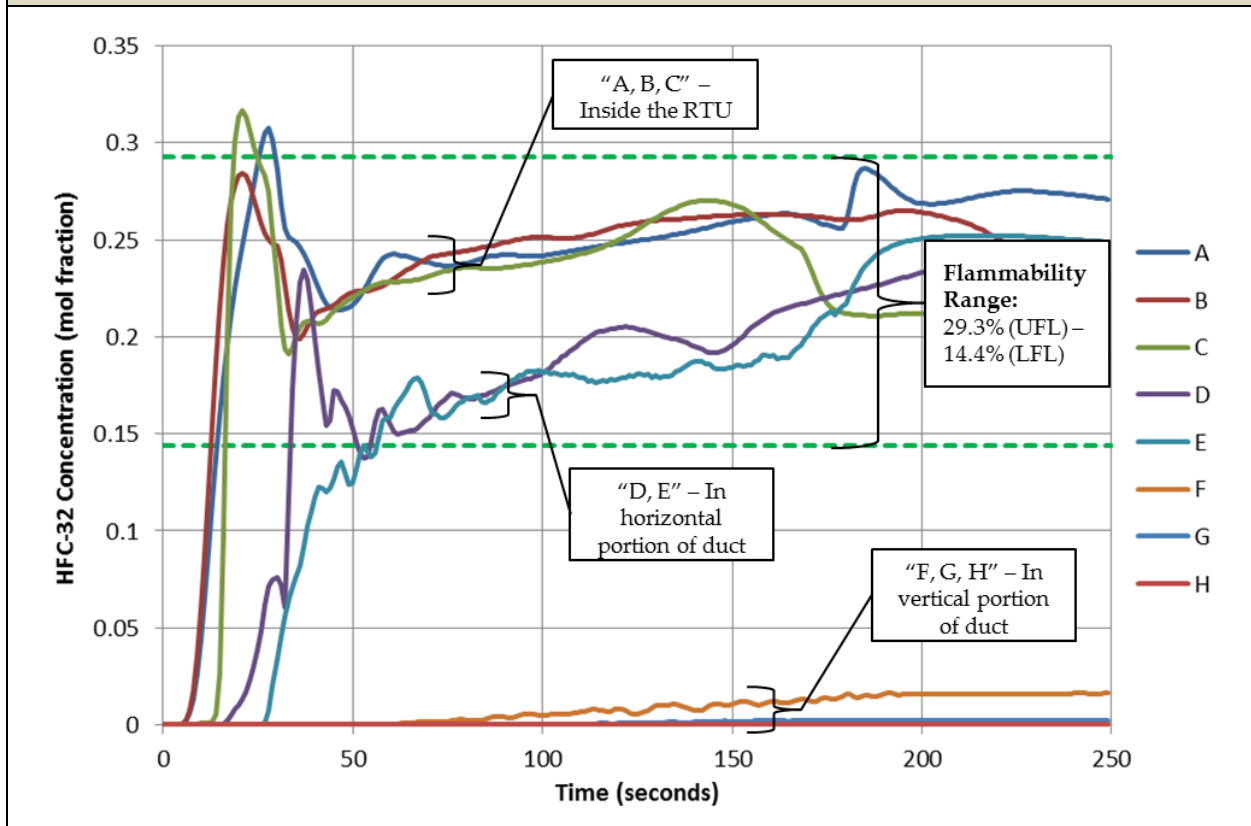

^a No air exchange with the air surrounding the RTU was modeled in this scenario, so the refrigerant concentration did not fall over time because there was nowhere for the refrigerant to disperse. However, the refrigerant would actually disperse slowly through the outdoor air inlet.

#	Equipment Type	Ref.	Location	Leak Type	Leak Location /Condition	Model Boundaries	Notes
8	5T on ground	R-32	Office	Fast	Evaporator – Blower off	RTU, ducting, and office space	Horizontal return duct
Leak Duration:		25% Leaked		50% Leaked		90% Leaked	
		12 Sec		28 Sec		94 Sec	
Flammability and Duration of Flammable Plume within each Region:			Inside the RTU/Ventilation		In Conditioned Space		Outside the RTU
			● 4 Min		● 3 Min		○

Concentration Plots at Each Monitoring Point:

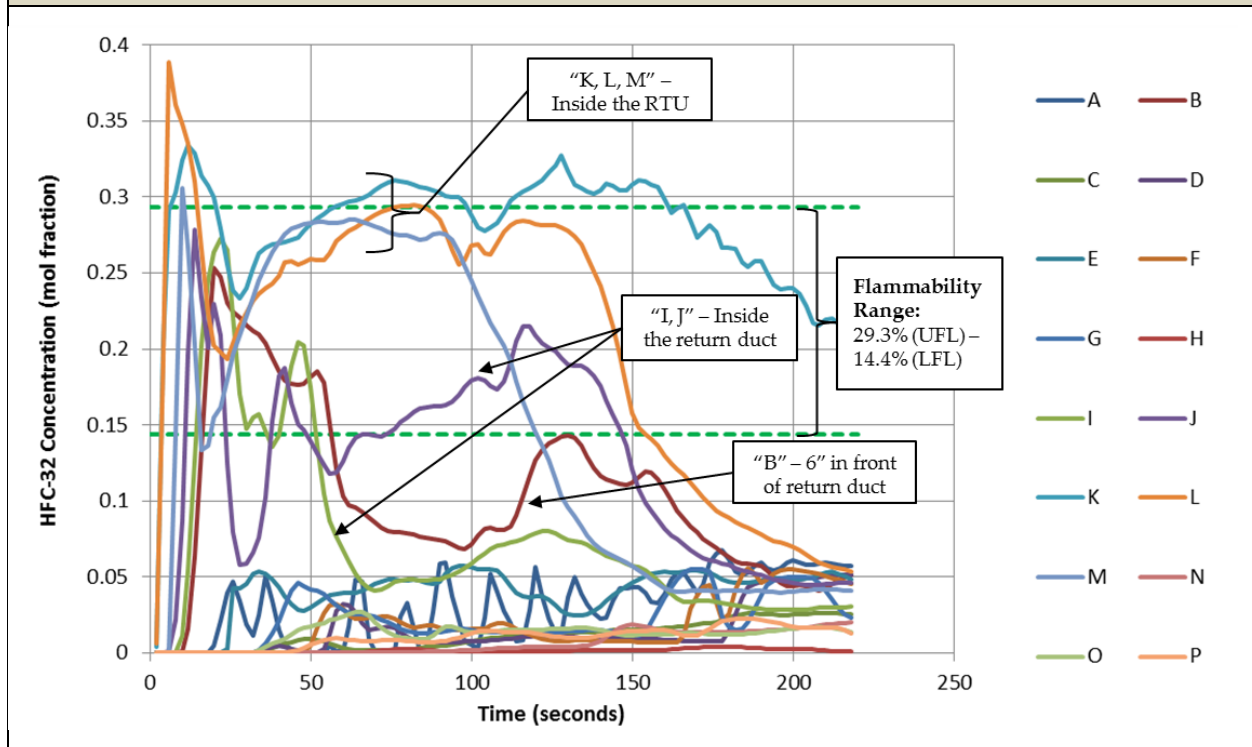

#	Equipment Type	Ref.	Location	Leak Type	Leak Location /Condition	Model Boundaries	Notes
9	5T on ground	R-1234yf	Office	Fast	Evaporator – Blower off	RTU, ducting, and office space	Horizontal return duct
Leak Duration:		25% Leaked		50% Leaked		90% Leaked	
		32 Sec		72 Sec		240 Sec	
Flammability and Duration of Flammable Plume within each Region:			Inside the RTU/Ventilation		In Conditioned Space		Outside the RTU
			● 5 Min		● 3 Min		○

Concentration Plots at Each Monitoring Point:

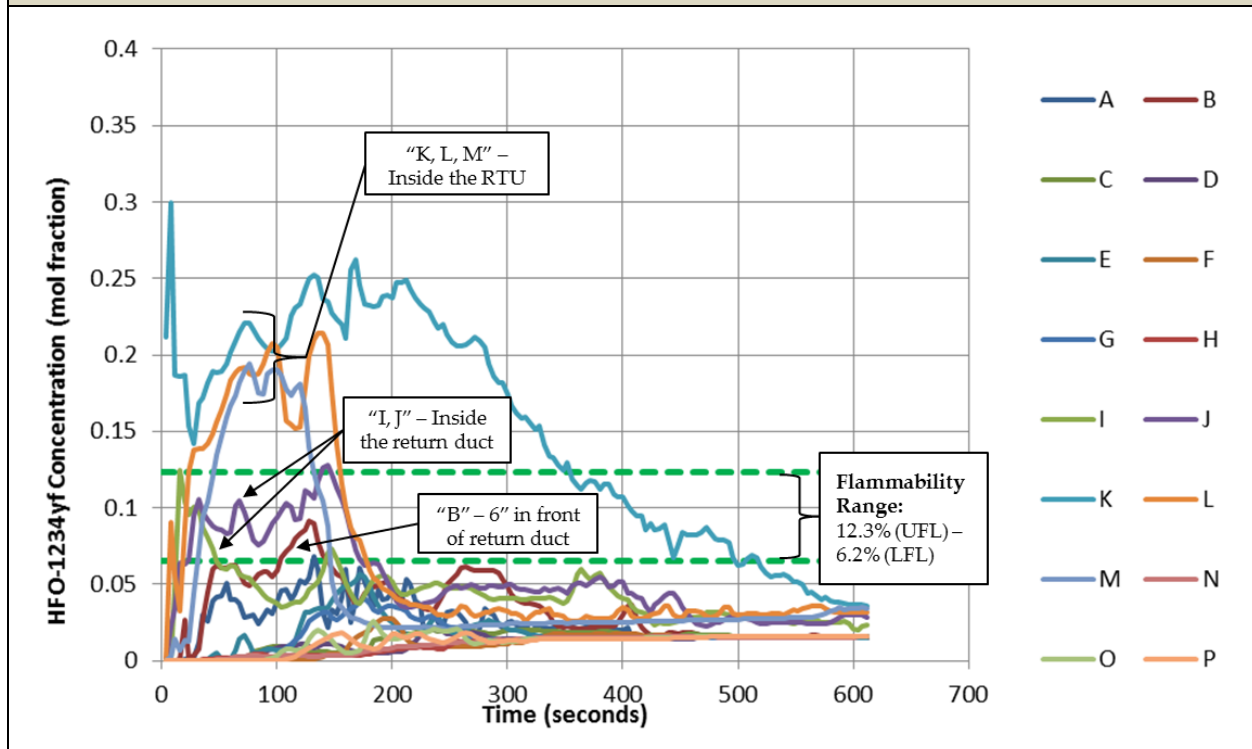

#	Equipment Type	Ref.	Location	Leak Type	Leak Location /Condition	Model Boundaries	Notes
10	15T on rooftop	R-1234yf	Office	Fast	Evaporator – Blower on	RTU, ducting, and office space	Exhaust hoods off
Leak Duration:		25% Leaked		50% Leaked		90% Leaked	
		13 Sec		31 Sec		103 Sec	
Flammability and Duration of Flammable Plume within each Region:			Inside the RTU/Ventilation		In Conditioned Space		Outside the RTU
			● 160 Sec		○		○

Concentration Plots at Each Monitoring Point:

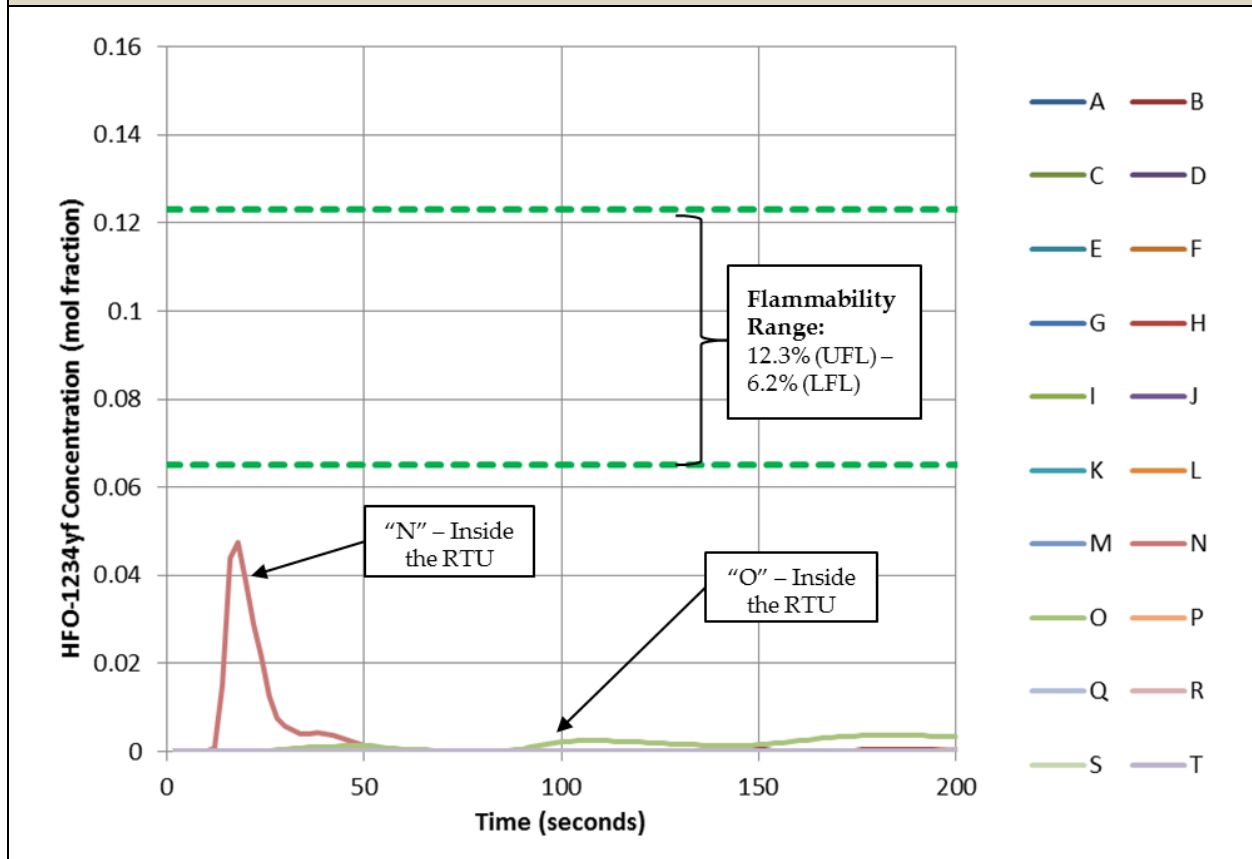

Appendix E. CFD Local Velocity Results

Local velocity has an important effect on the ignition risk of 2L refrigerants (see section 4.4 for additional detail). Therefore we used the CFD analysis to provide insight into the local velocity distribution as well as the refrigerant concentration distribution in the modeled space after a refrigerant leak. Specifically, we examined the local velocity over time at the same monitoring points used for analyzing concentration, for Scenarios 1 and 2 (15T RTU serving a commercial kitchen, with leaks of R-32 and R-1234yf, respectively). Plots showing corresponding plots of concentration over time and local velocity over time are shown below, for the monitoring points which developed the highest refrigerant concentrations in each scenario.

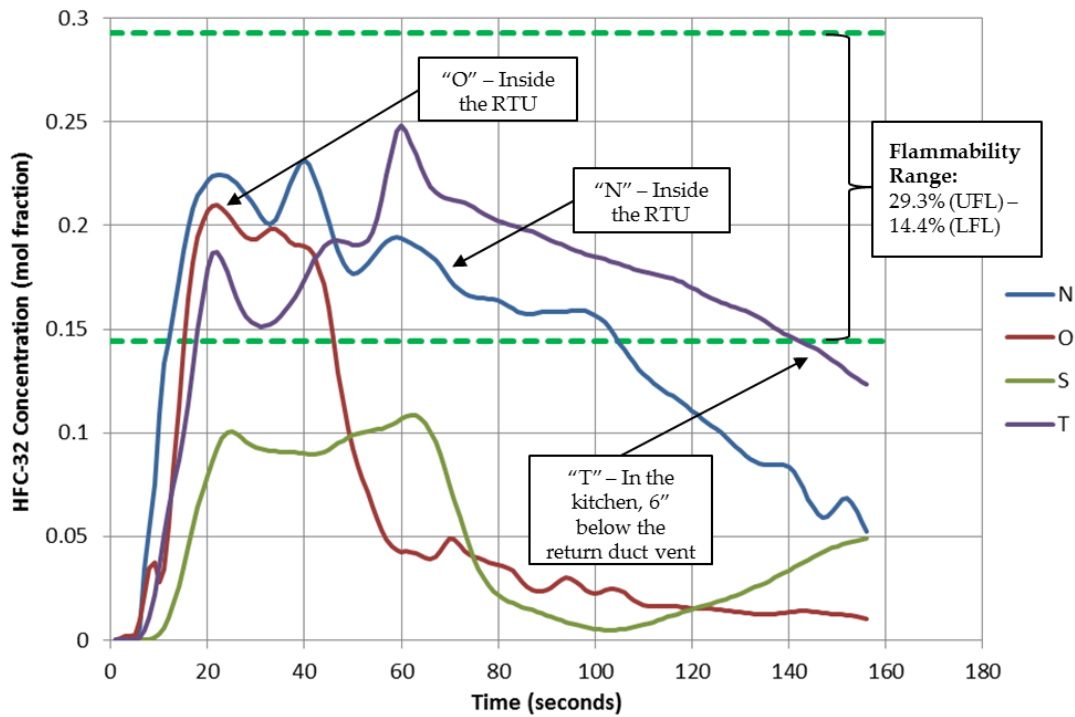

Figure 6.24: Concentration vs Time for Scenario 1 – Fast evaporator leak of R-32 from a 15T roof-mounted RTU serving a commercial kitchen

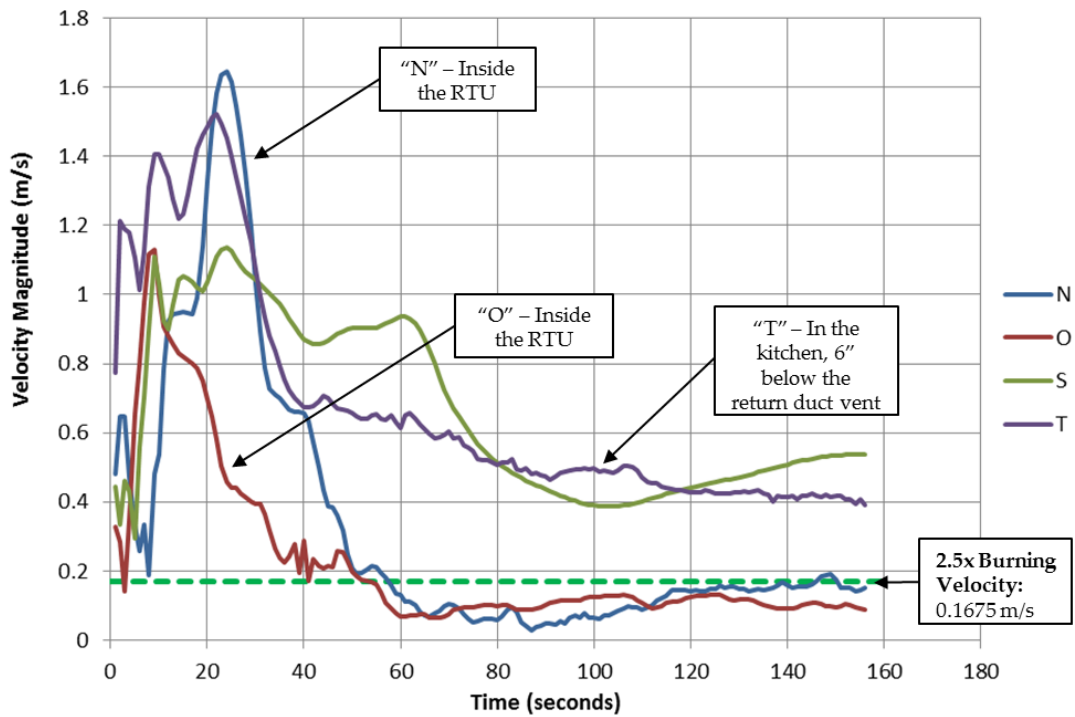

Figure 6.25: Local Velocity vs Time for Scenario 1 – Fast evaporator leak of R-32 from a 15T roof-mounted RTU serving a commercial kitchen

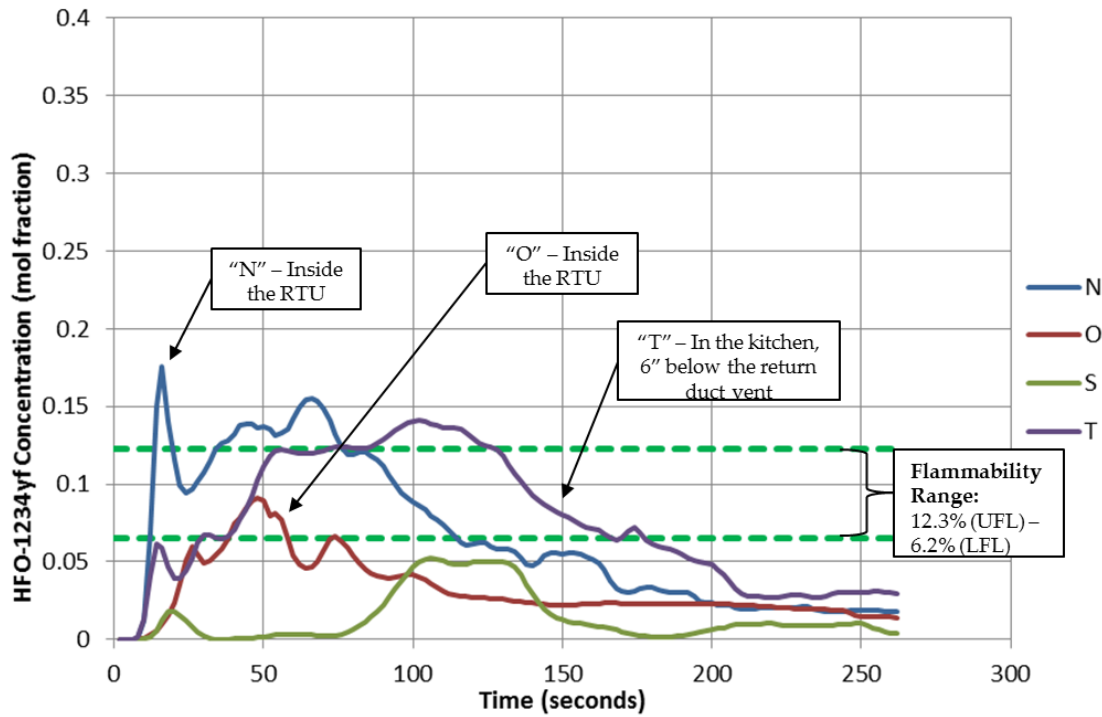

Figure 6.26: Concentration vs Time for Scenario 2 – Fast evaporator leak of R-1234yf from a 15T roof-mounted RTU serving a commercial kitchen

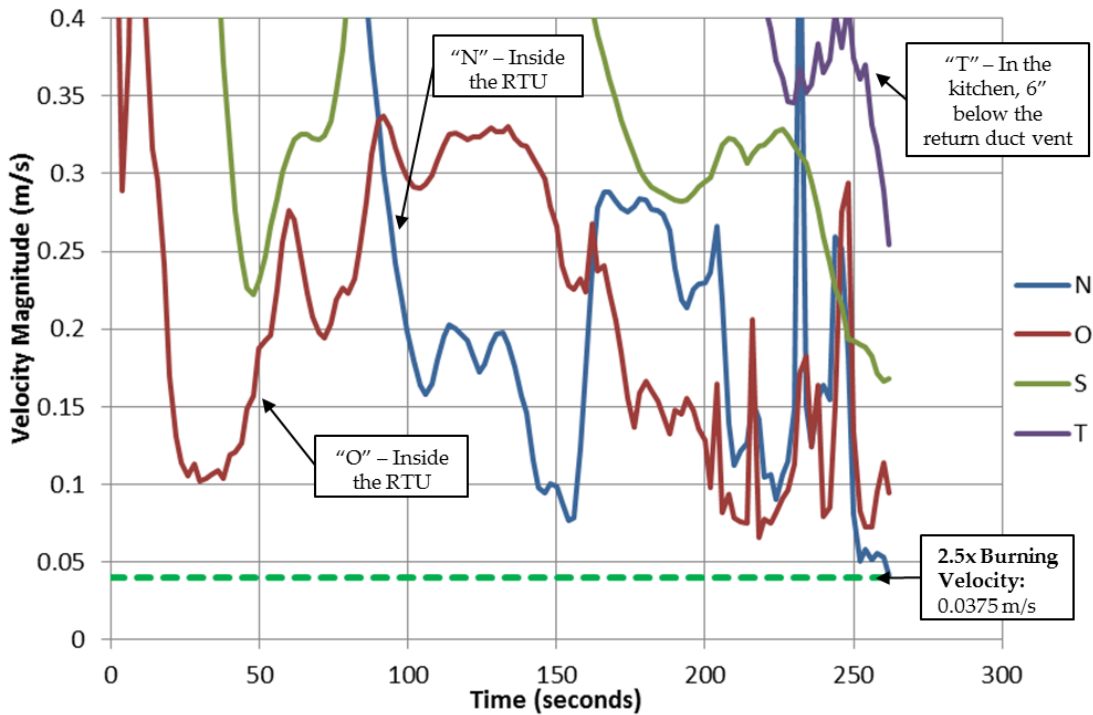

Figure 6.27: Local Velocity vs Time for Scenario 2 – Fast evaporator leak of R-1234yf from a 15T roof-mounted RTU serving a commercial kitchen



AHRI Project No. 8016: Risk Assessment of Class 2L Refrigerants in Commercial Rooftop Units

Fault Trees and Fault Tree Input Details

Prepared for:



we make life better™

Prepared by:

**Bill Goetzler
Matt Guernsey
Sean Faltermeier
Michael Droesch**

Navigant Consulting, Inc.
77 South Bedford St.
Suite 400
Burlington, MA 01803

781.270.0101
www.navigant.com

**Final Report
May 2016**



© 2016 AHRI

Table of Contents

1. Overview

Appendix A. Fault TreesA-1

A.1 Fault Trees for Scenario A – 15T RTU Serving a Commercial Kitchen A-1

A.2 Fault Trees for Scenario C – 25T RTU Serving an Office A-46

A.3 Fault Trees for Scenario E – 5T Ground-Mounted RTU Serving an Office A-62

Appendix B. Fault Tree Rationales..... B-82

B.1 Fault Tree Rationale for Scenarios A and B – 15T RTU Serving a Commercial Kitchen B-82

B.2 Fault Tree Rationale for Scenario C – 25T RTU Serving an Office B-92

B.3 Fault Tree Rationale for Scenario E – 5T Ground-Mounted RTU with R-32 Serving an OfficeB-98

1. Overview

This appendix includes fault trees and details for inputs to fault trees for the fault tree analysis (FTA) carried out for AHRI 8016. As part of the FTA, we developed fault trees for four scenarios: Scenarios A, B, C, and E. Scenarios A, C, and E all address risk of ignition of R-32, and Scenario B addresses risk of ignition of R-1234yf.

For Scenario B, different FTA inputs were used as compared to Scenario A; however, the same fault tree structure was used for both scenarios, because both include the same locations and ignition sources. Therefore, Appendix A does not include the fault tree for Scenario B because it is identical to that of Scenario A, except for different input values. The input values for both Scenarios A and B are listed in Appendix B.1.

For Scenarios D and F, annual risks were calculated using a scaling factor developed from the analyzed fault trees for Scenarios A, B, C, and E. Therefore, fault trees and input values for these two scenarios are not included in this appendix.

A.1 Fault Trees for Scenario A – 15T RTU Serving a Commercial Kitchen

Overall Fault Tree

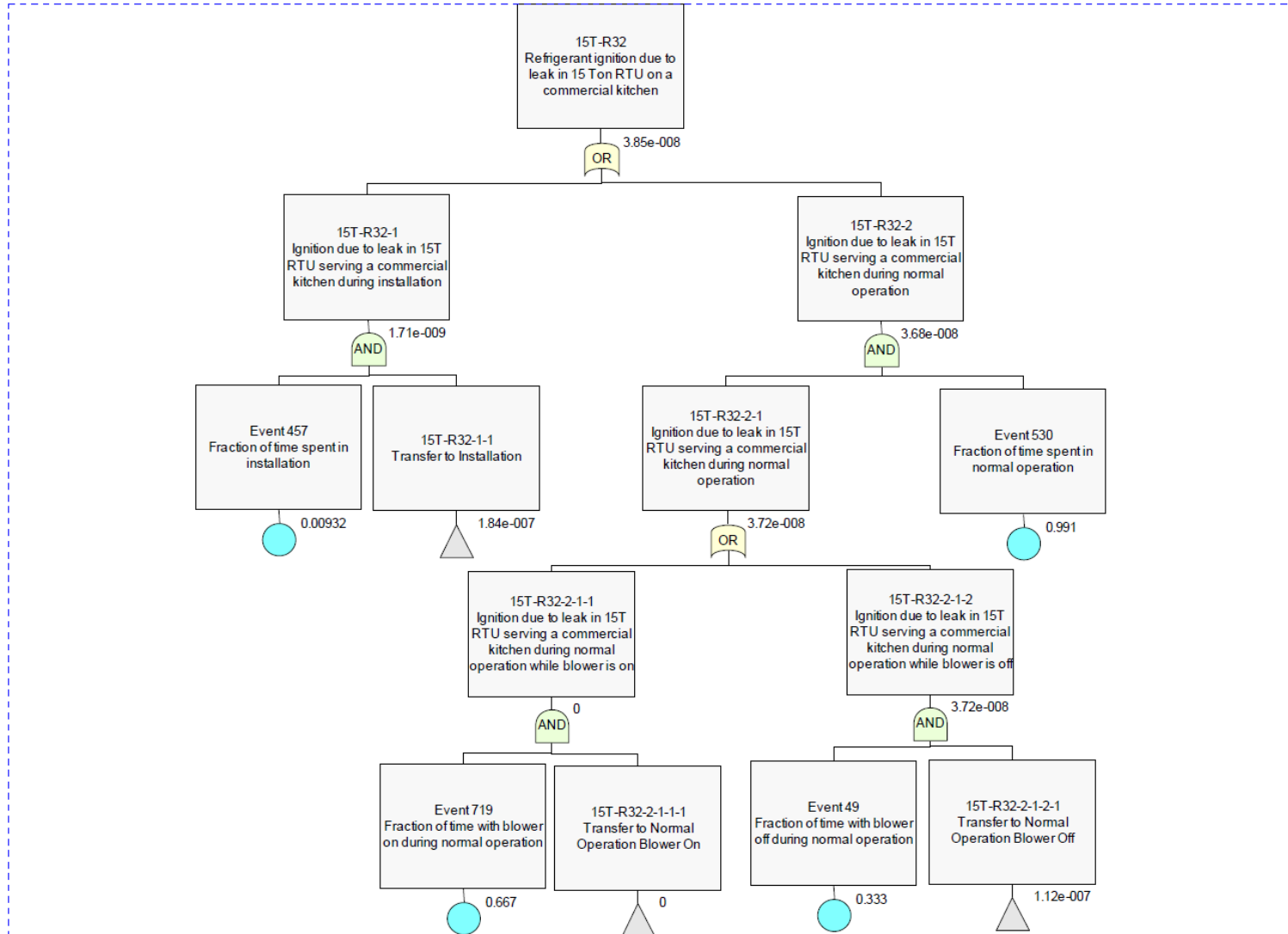

15T RTU Serving a Commercial Kitchen – Normal Operation with Blower Off – Page 1

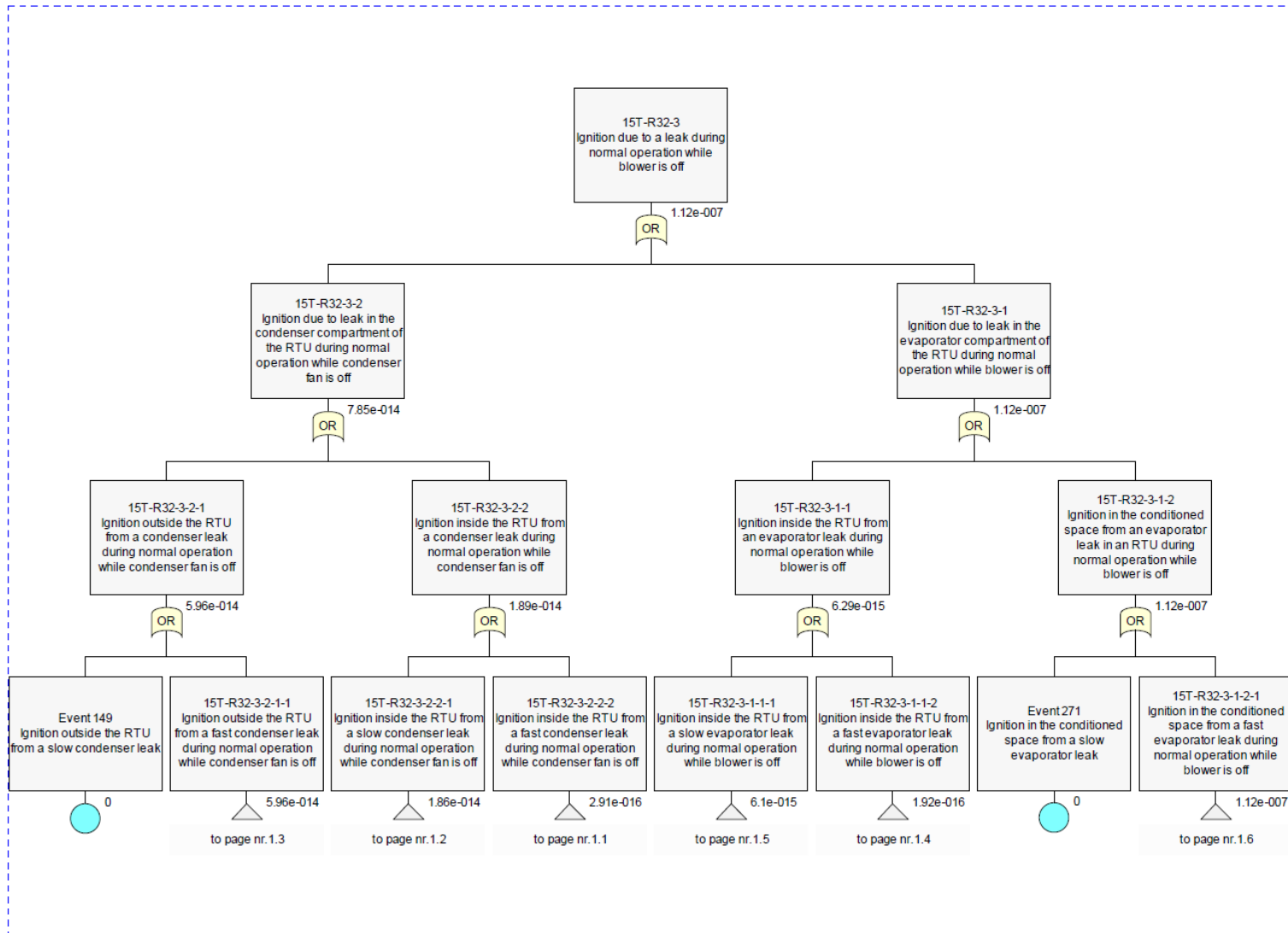

15T RTU Serving a Commercial Kitchen – Normal Operation with Blower Off – Page 1.1

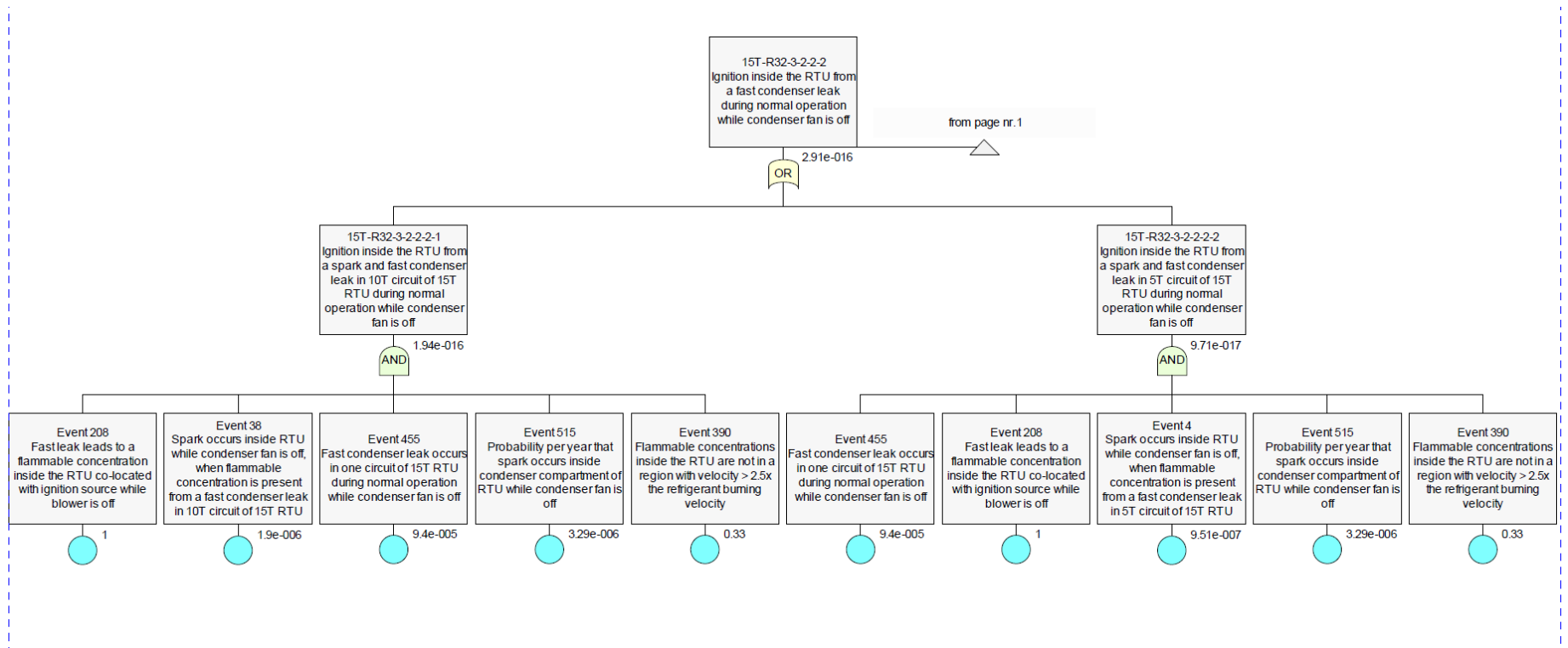

15T RTU Serving a Commercial Kitchen – Normal Operation with Blower Off – Page 1.2

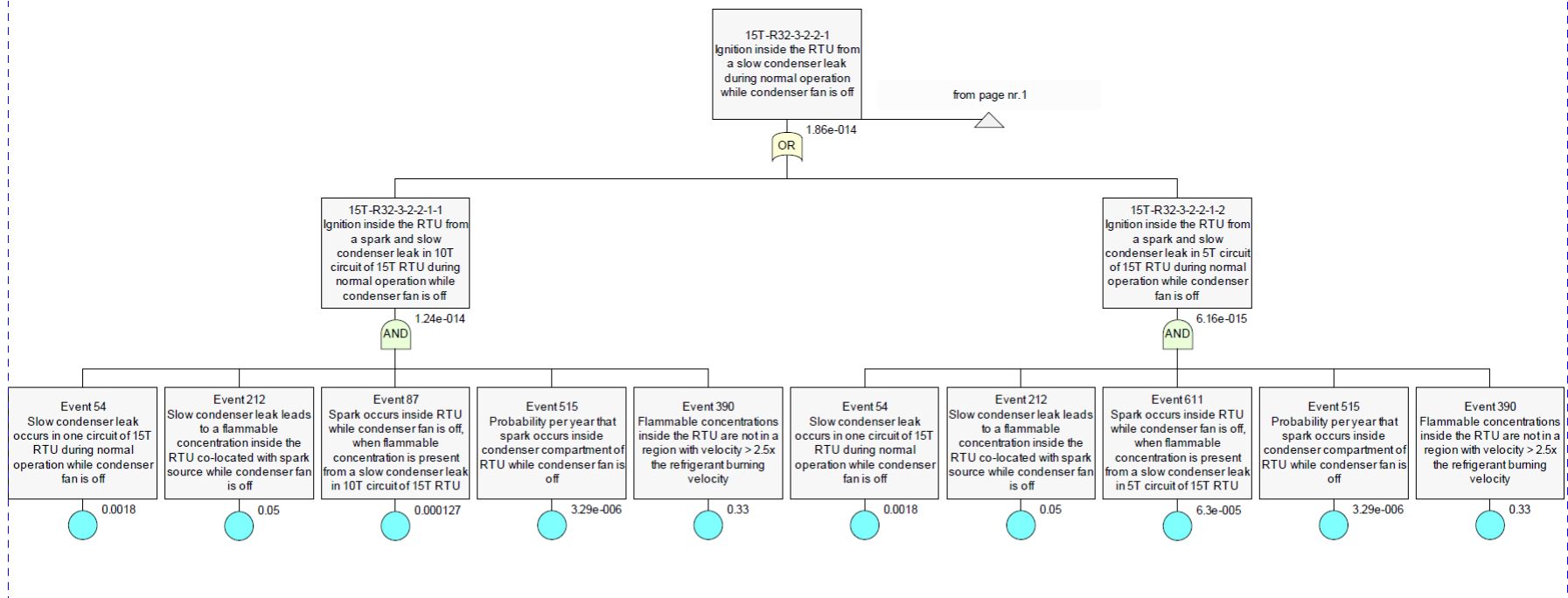

15T RTU Serving a Commercial Kitchen – Normal Operation with Blower Off – Page 1.3

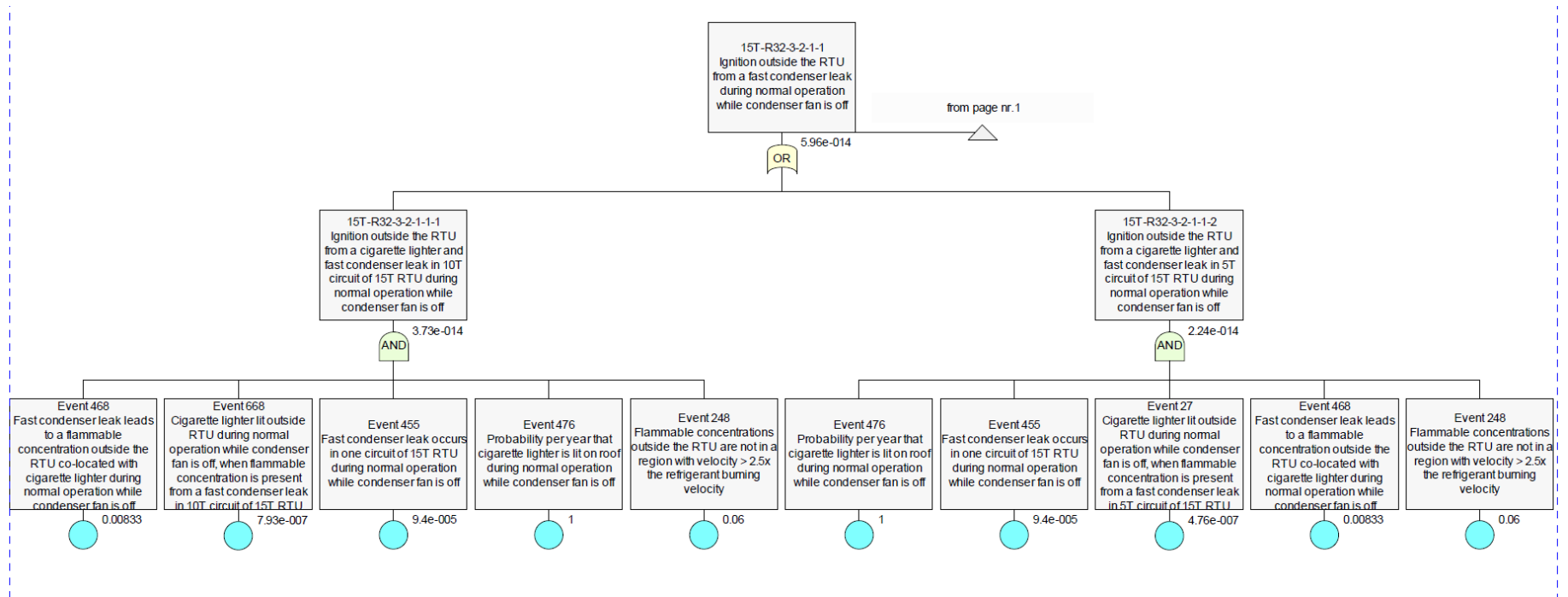

15T RTU Serving a Commercial Kitchen – Normal Operation with Blower Off – Page 1.4

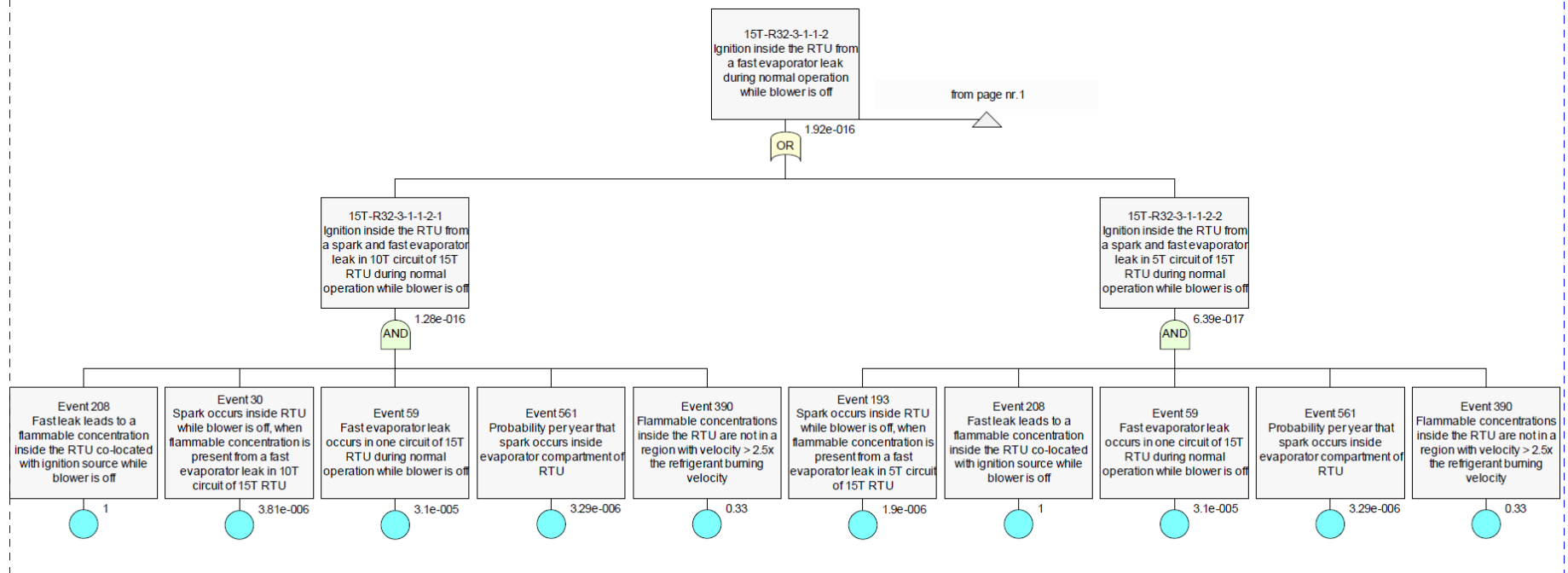

15T RTU Serving a Commercial Kitchen – Normal Operation with Blower Off – Page 1.5

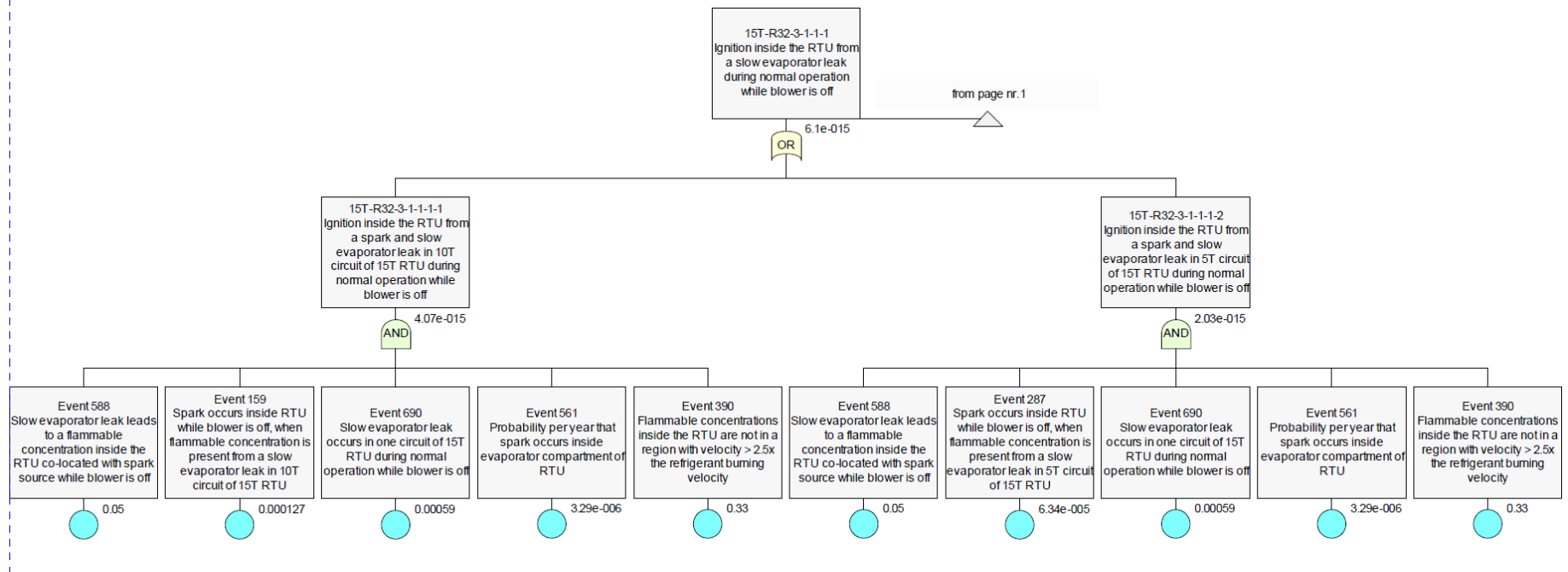

15T RTU Serving a Commercial Kitchen – Normal Operation with Blower Off – Page 1.6

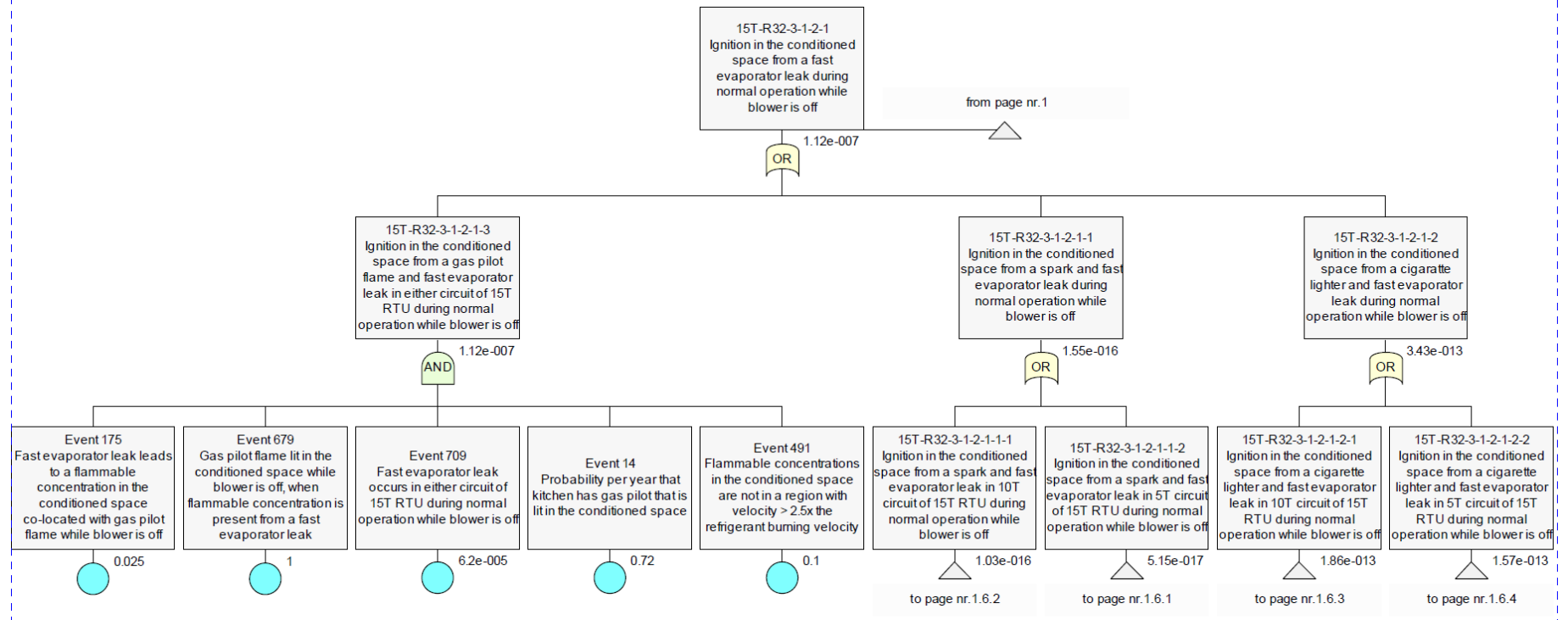

15T RTU Serving a Commercial Kitchen – Normal Operation with Blower Off – Page 1.6.1

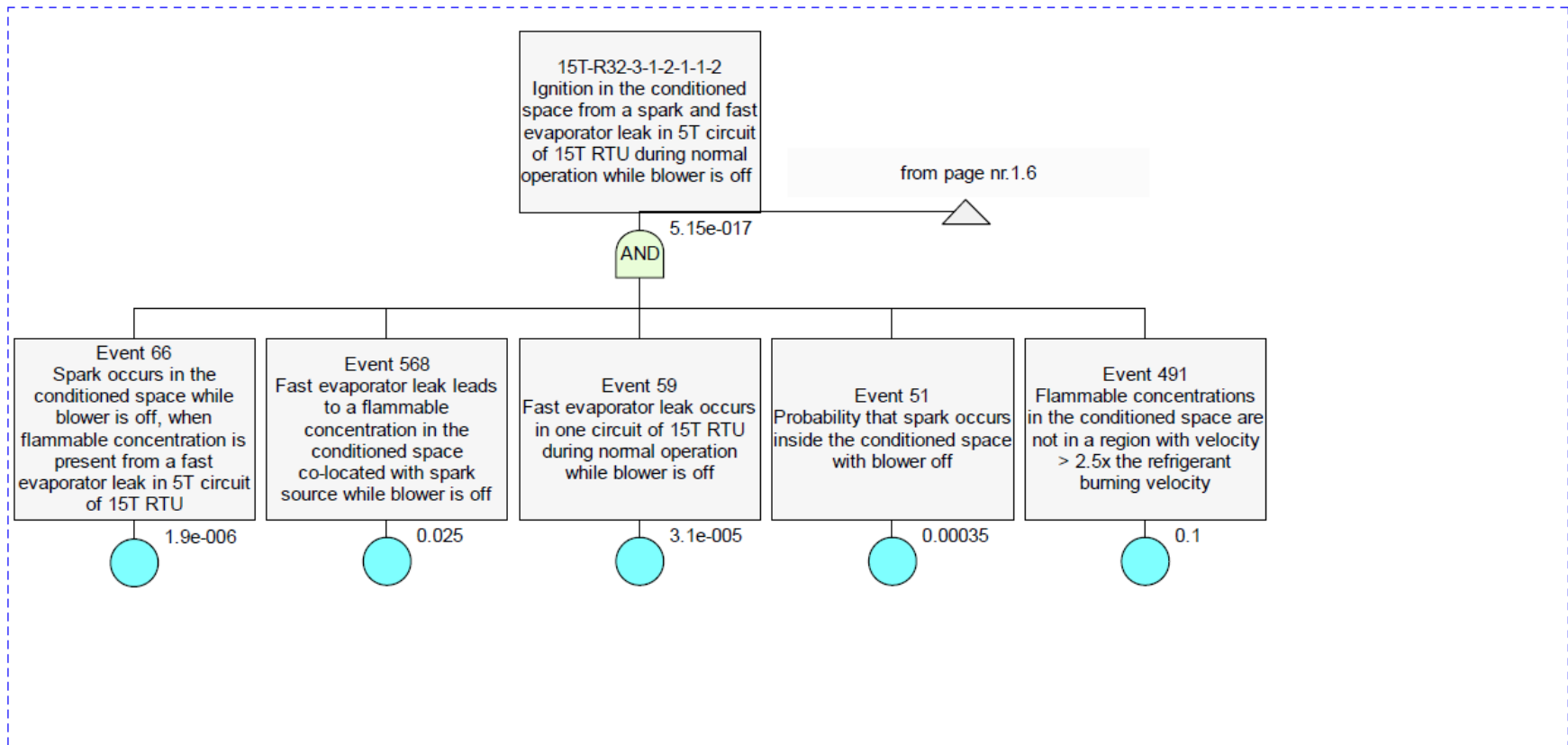

15T RTU Serving a Commercial Kitchen – Normal Operation with Blower Off – Page 1.6.2

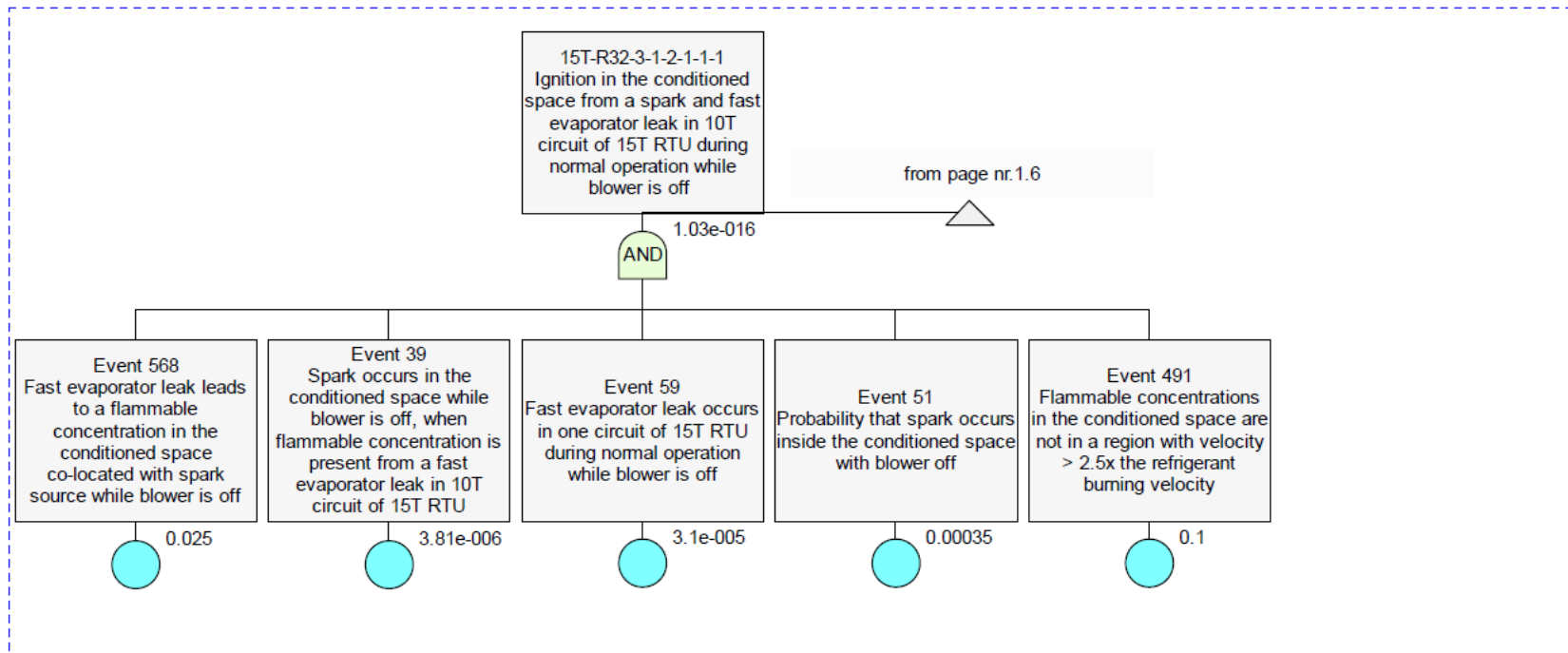

15T RTU Serving a Commercial Kitchen – Normal Operation with Blower Off – Page 1.6.3

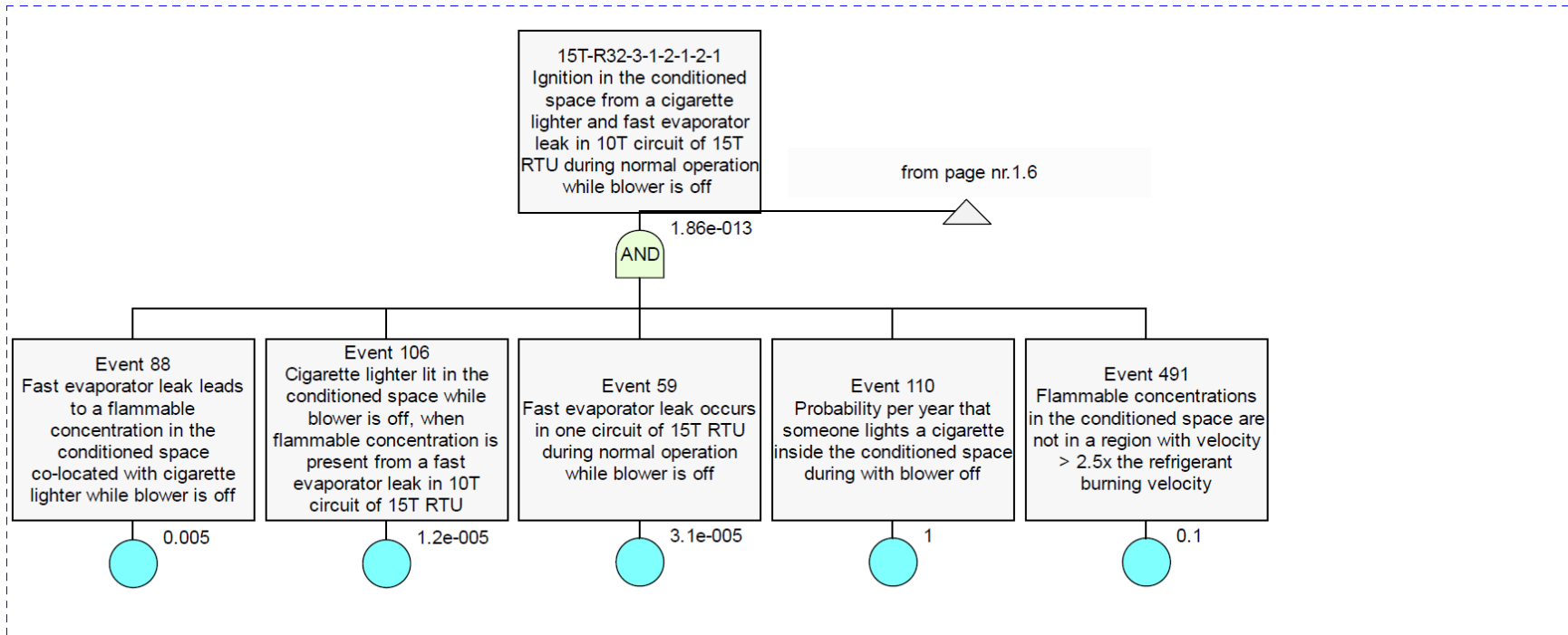

15T RTU Serving a Commercial Kitchen – Normal Operation with Blower Off – Page 1.6.4

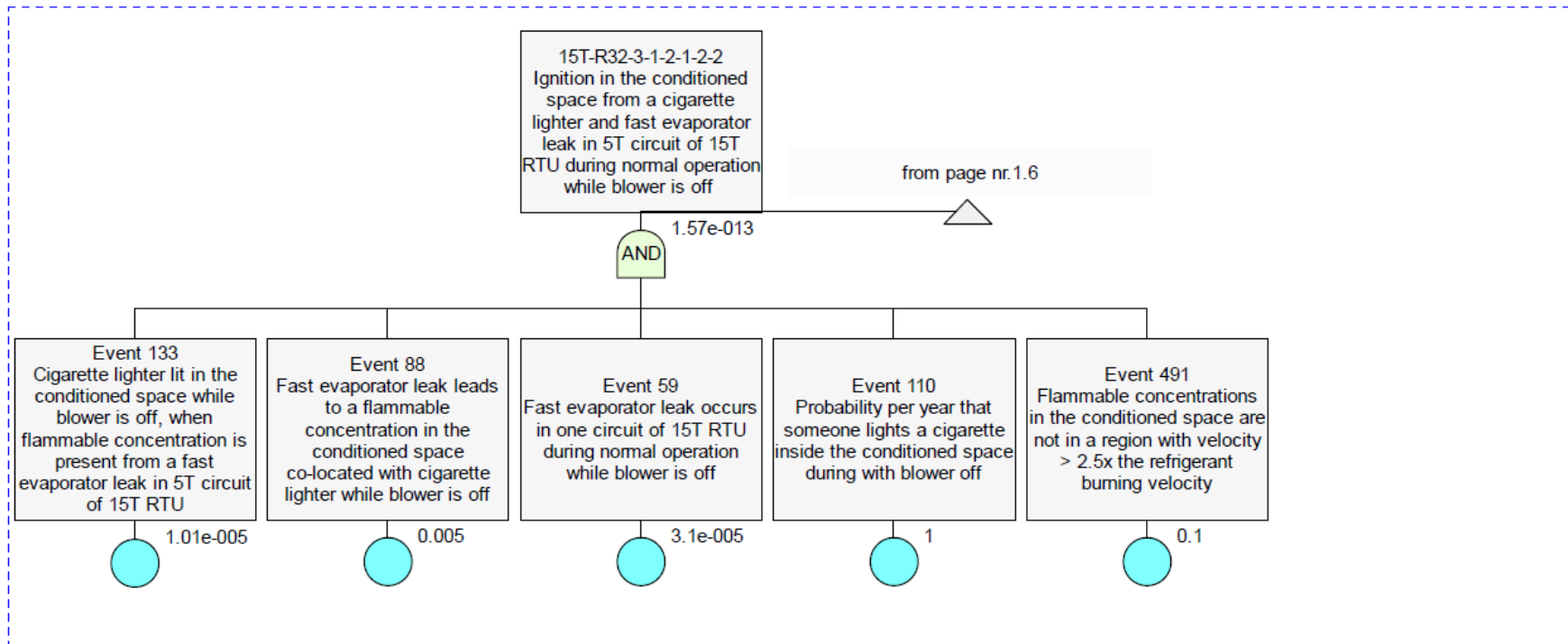

15T RTU Serving a Commercial Kitchen – Normal Operation with Blower On

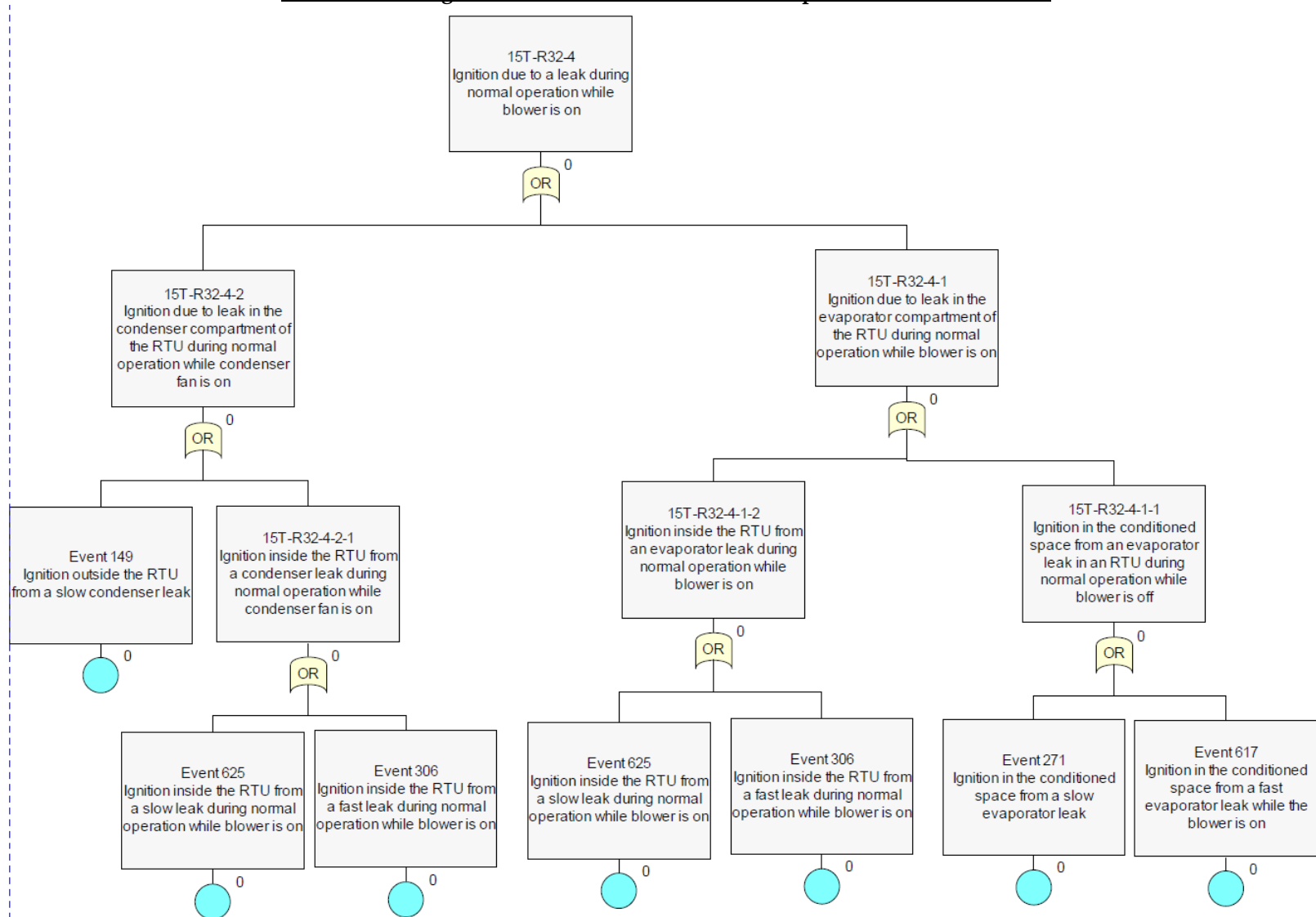

15T RTU Serving a Commercial Kitchen – Installation – Page 1

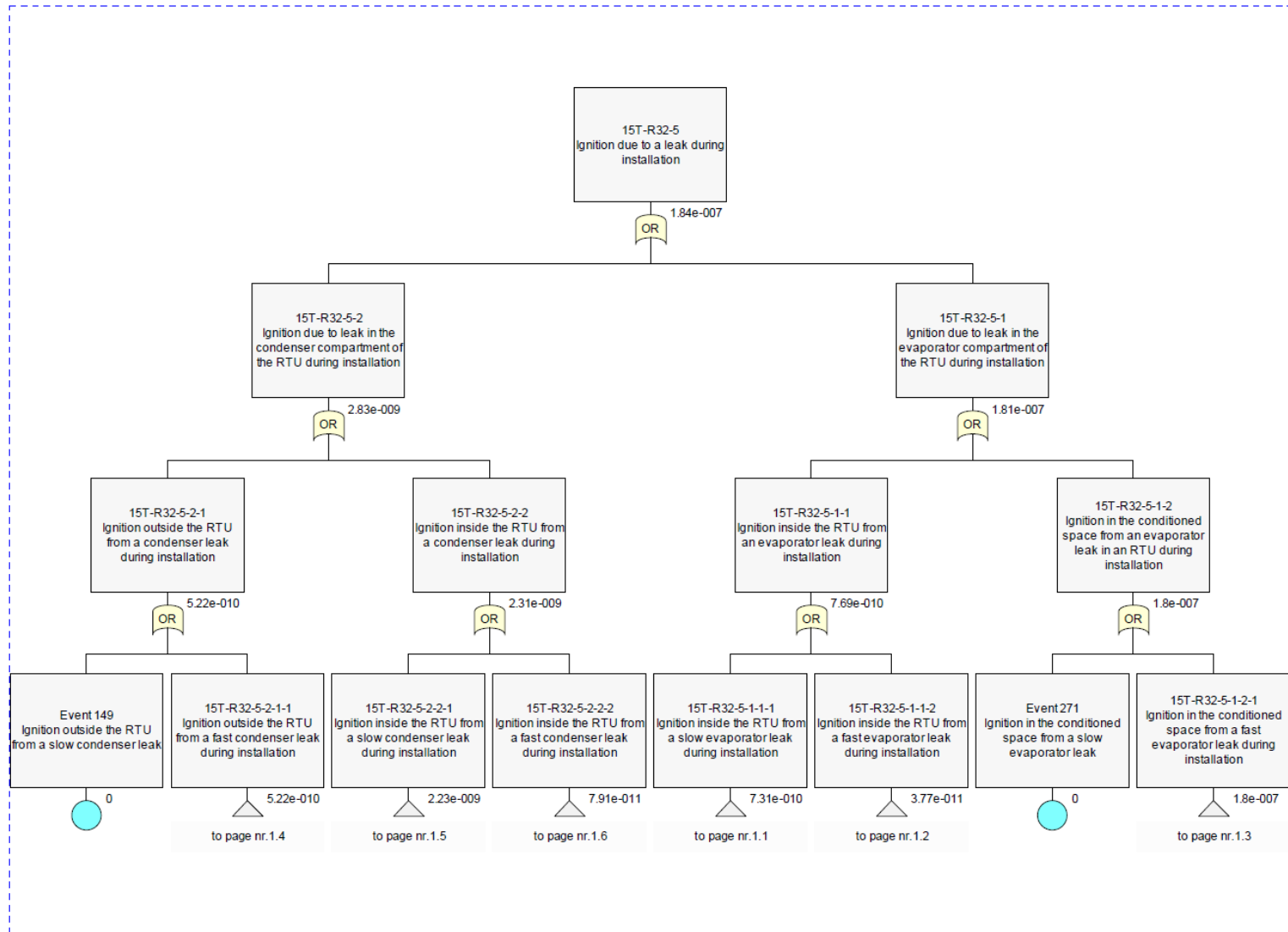

15T RTU Serving a Commercial Kitchen – Installation – Page 1.1

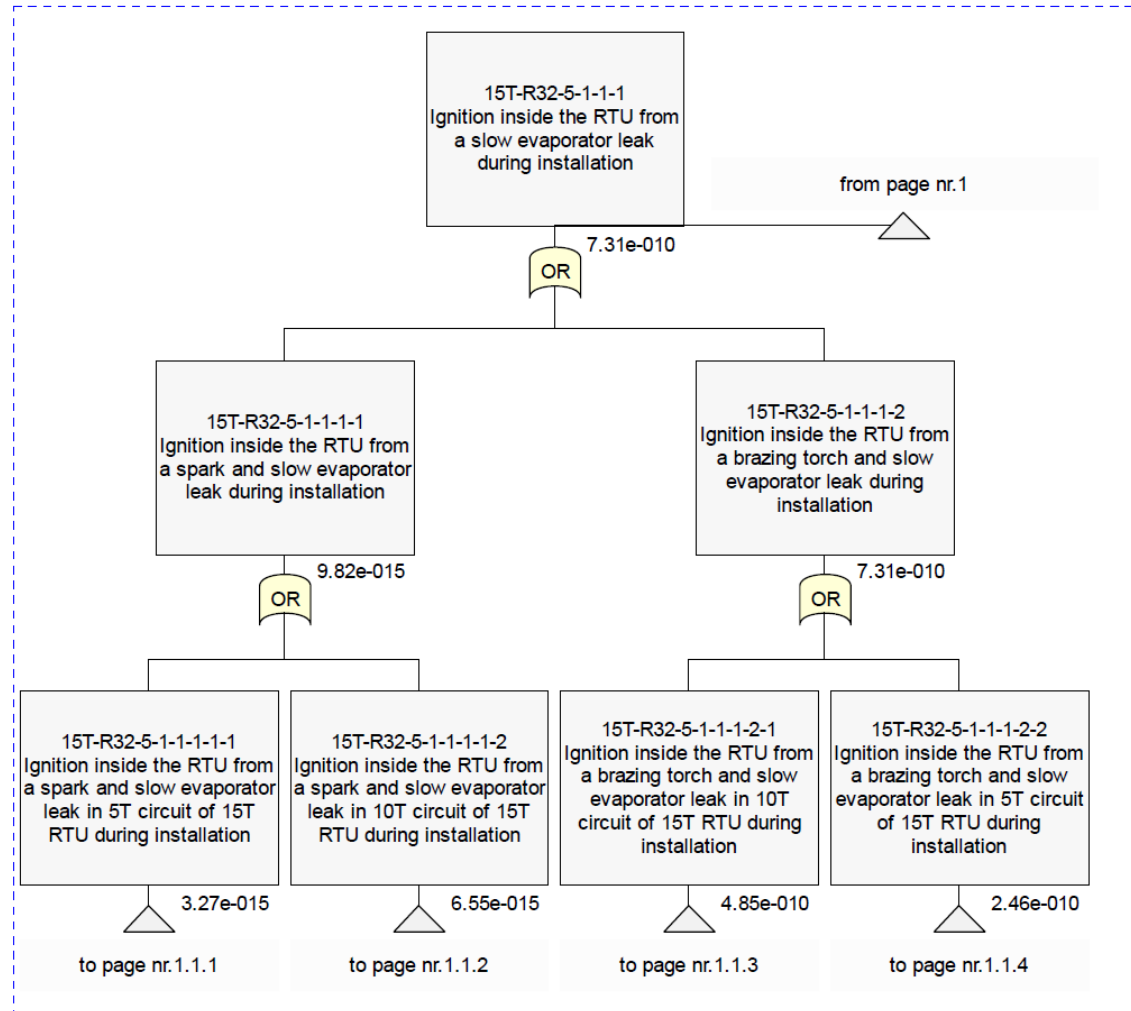

15T RTU Serving a Commercial Kitchen – Installation – Page 1.1.1

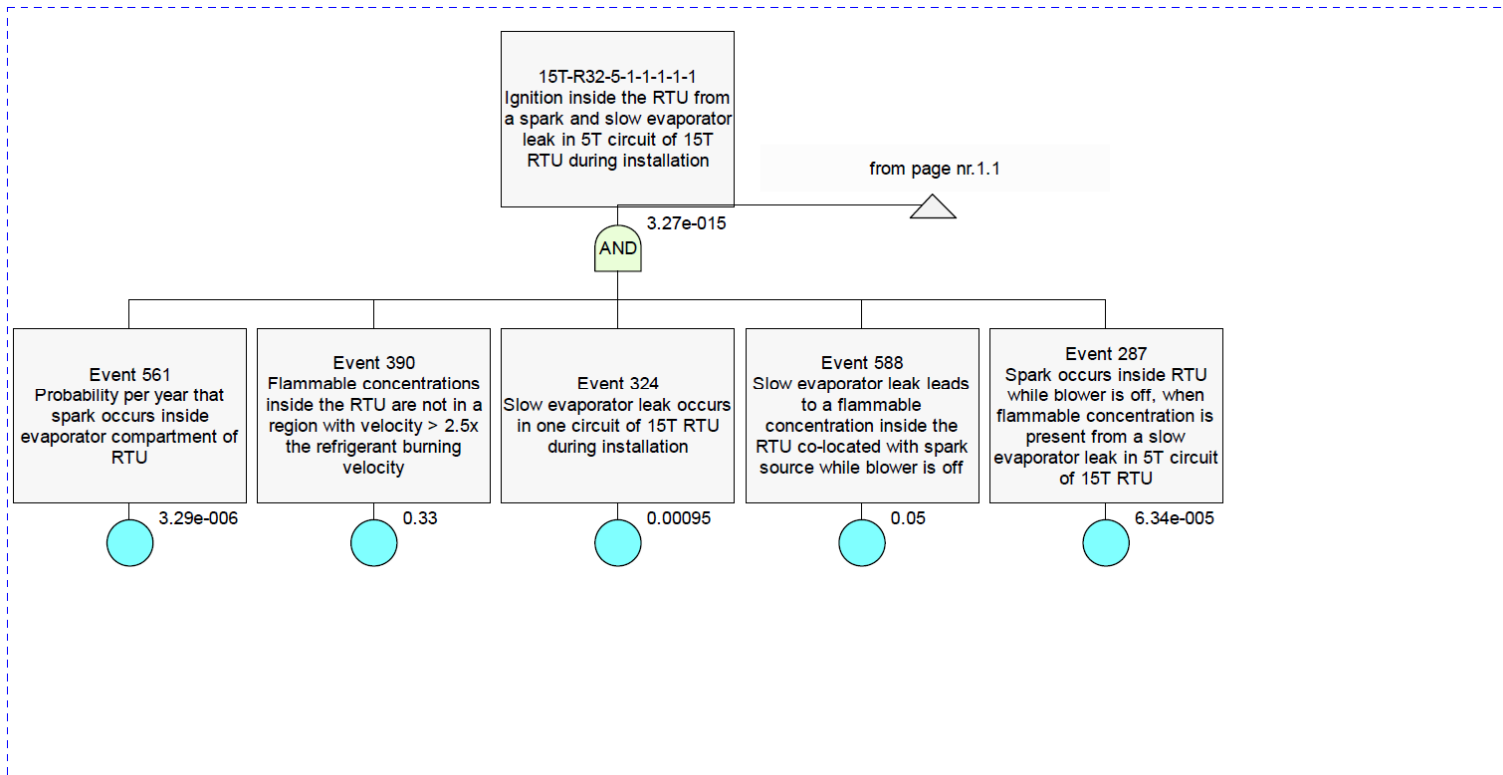

15T RTU Serving a Commercial Kitchen – Installation – Page 1.1.2

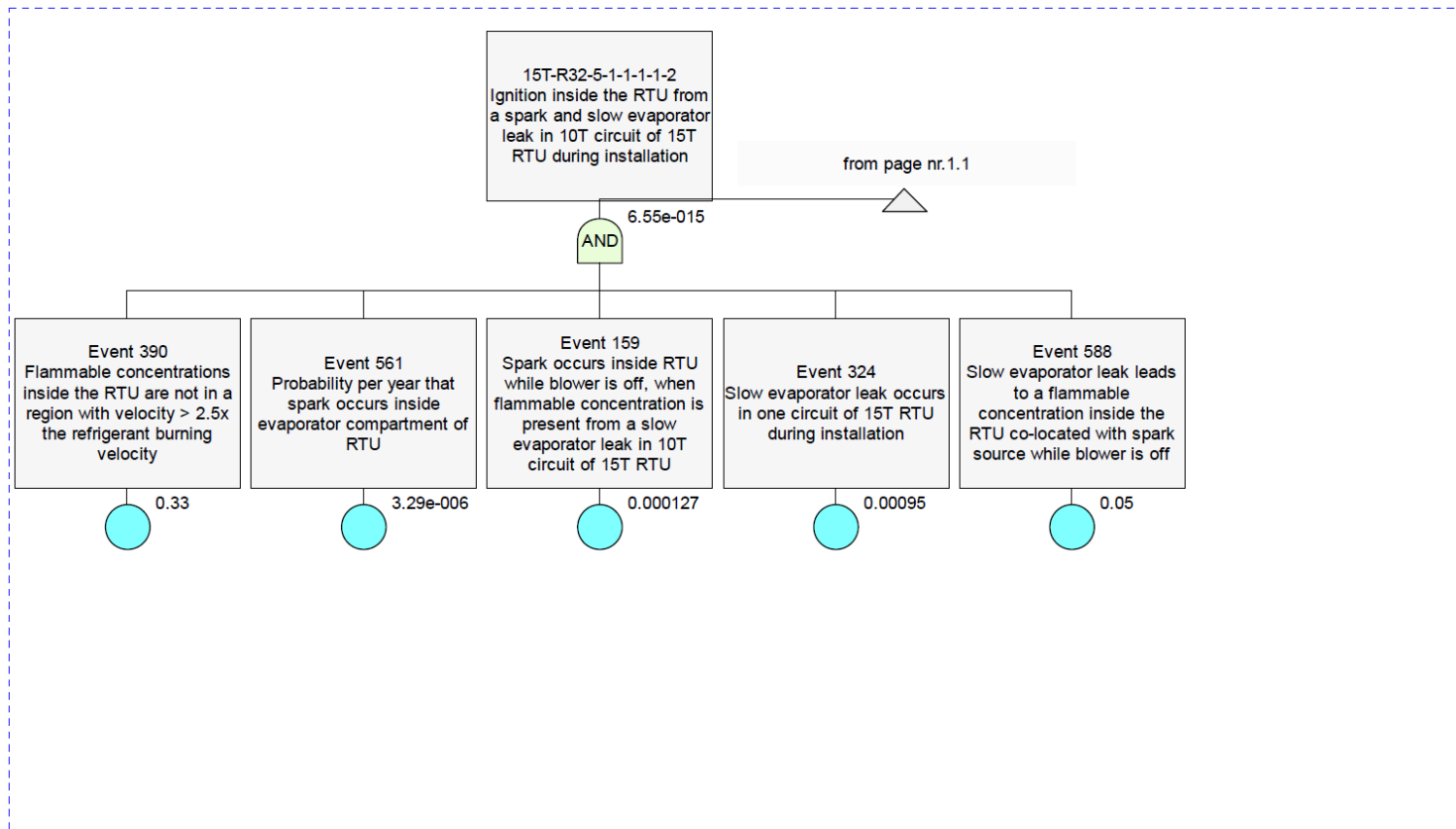

15T RTU Serving a Commercial Kitchen – Installation – Page 1.1.3

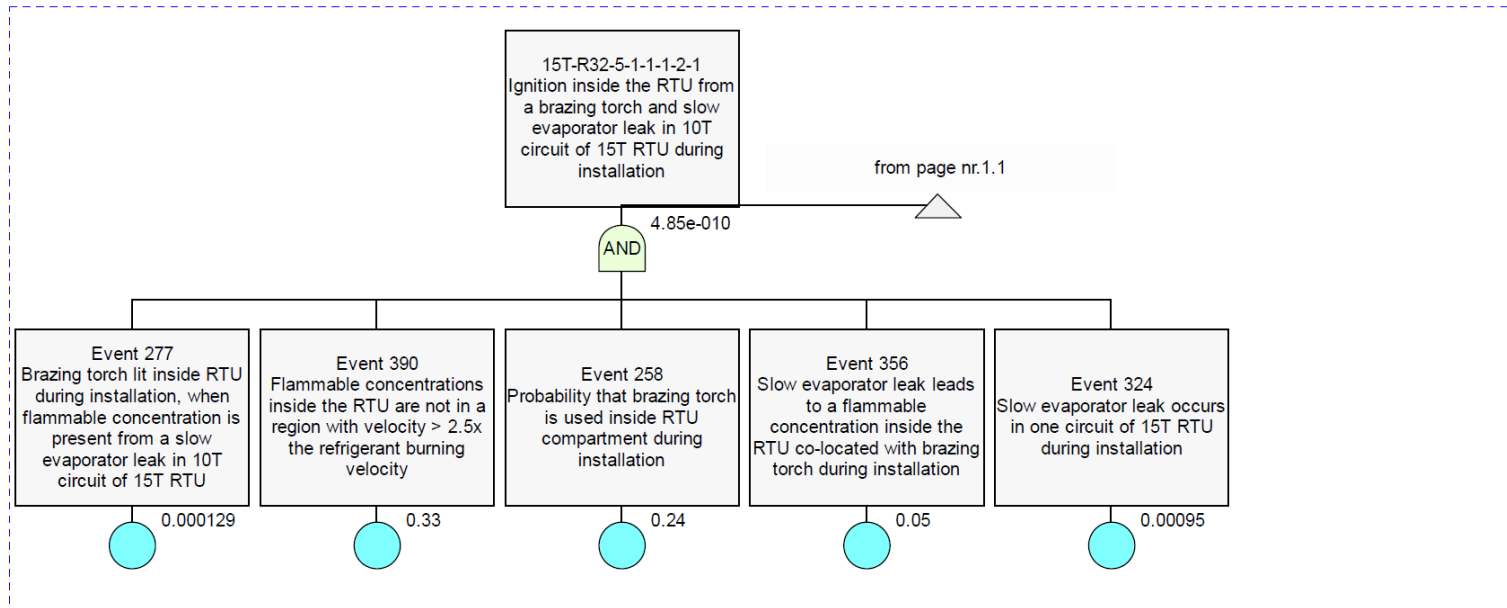

15T RTU Serving a Commercial Kitchen – Installation – Page 1.1.4

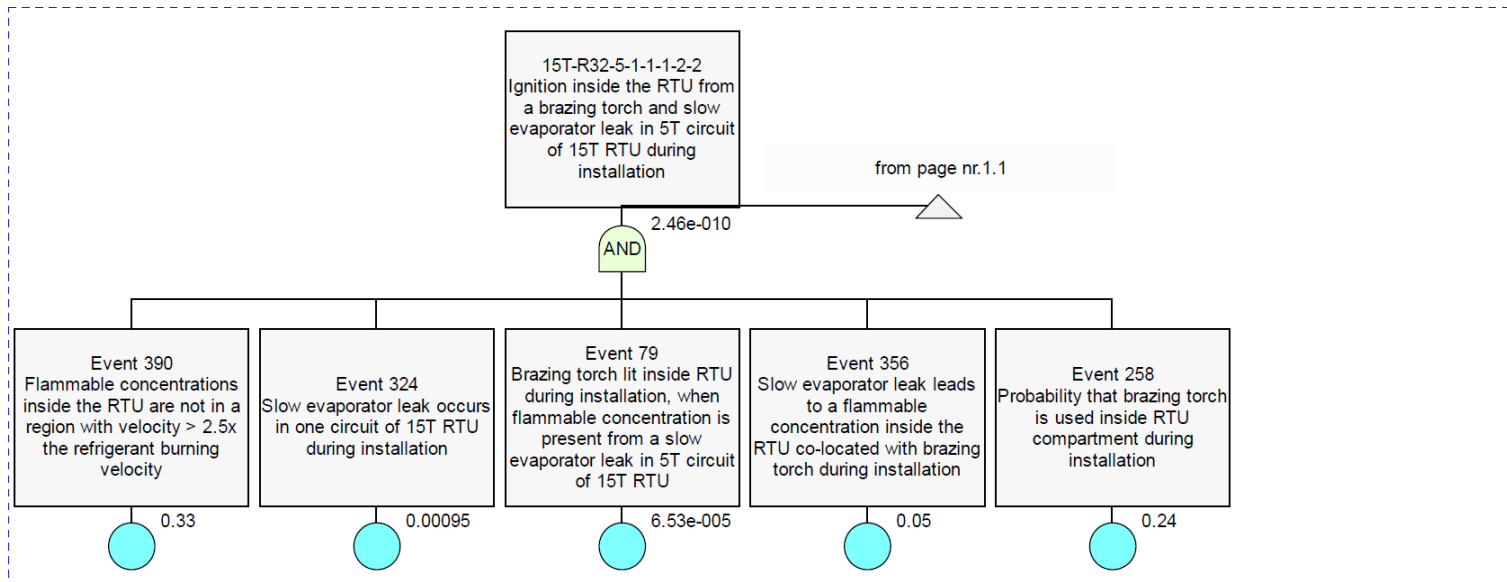

15T RTU Serving a Commercial Kitchen – Installation – Page 1.2

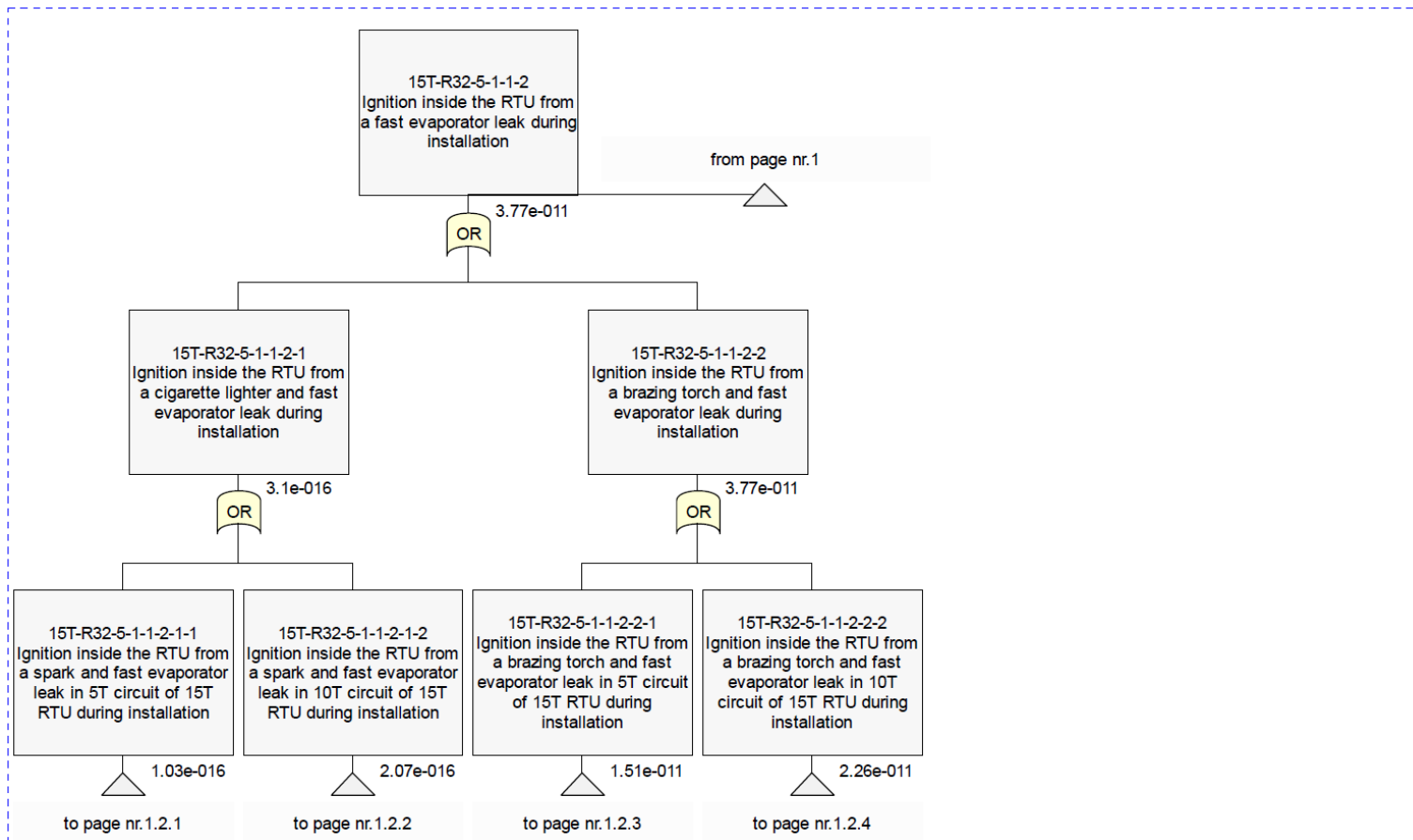

15T RTU Serving a Commercial Kitchen – Installation – Page 1.2.1

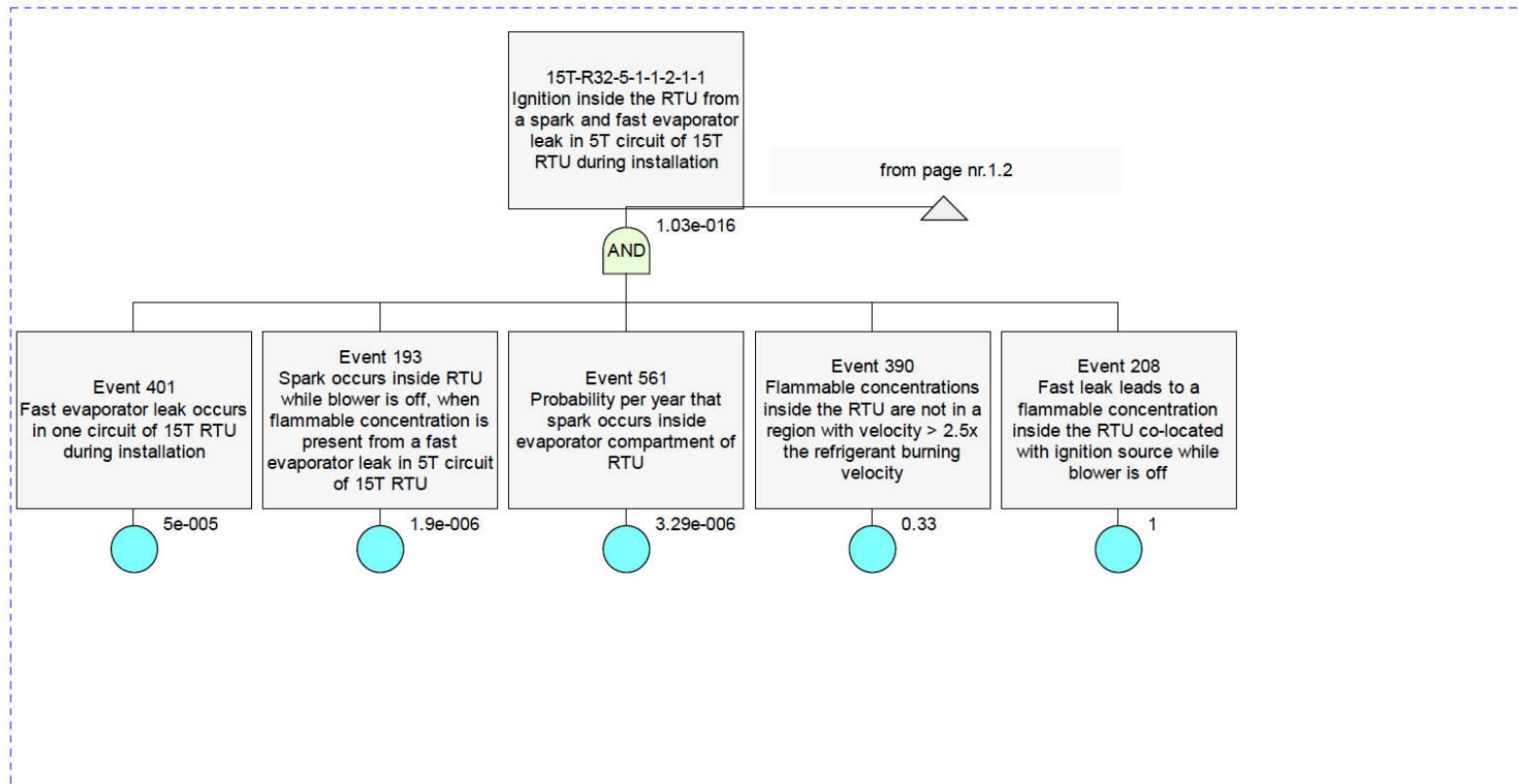

15T RTU Serving a Commercial Kitchen – Installation – Page 1.2.2

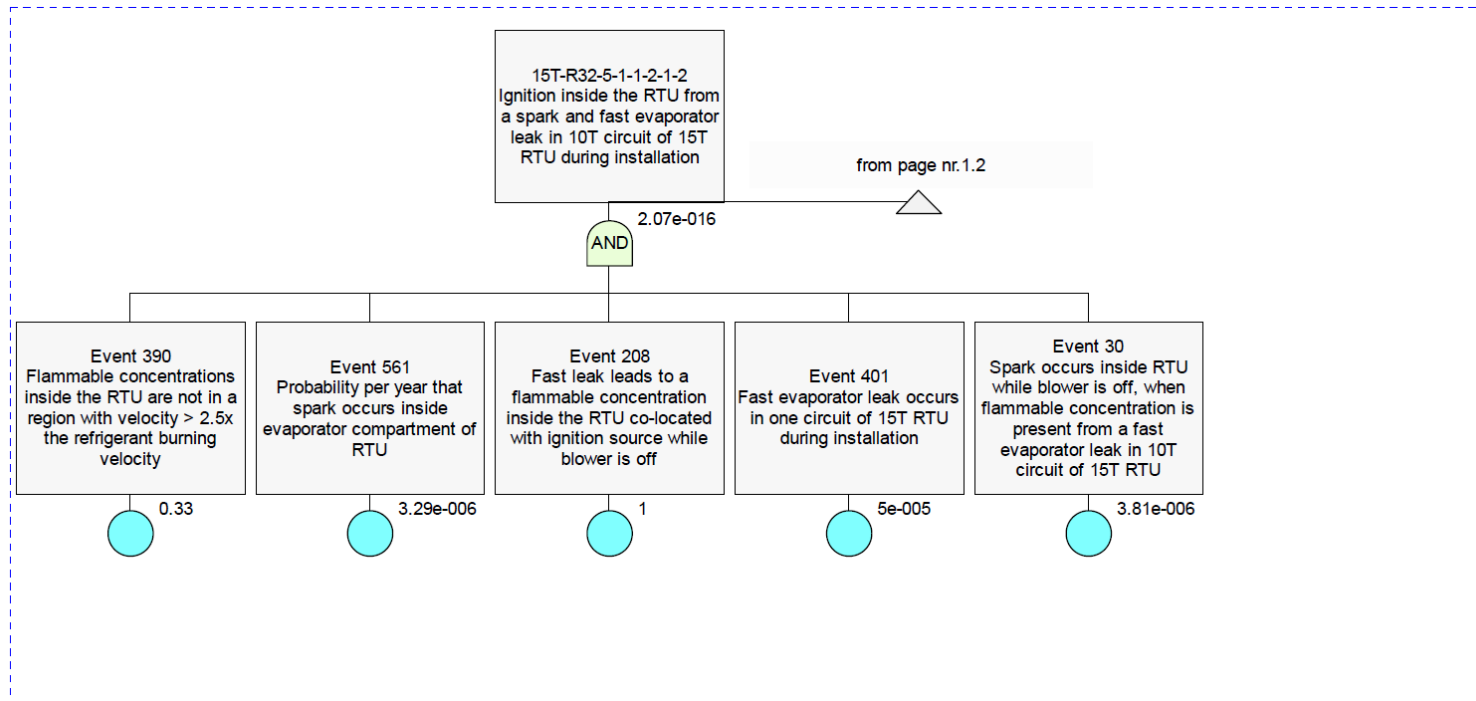

15T RTU Serving a Commercial Kitchen – Installation – Page 1.2.3

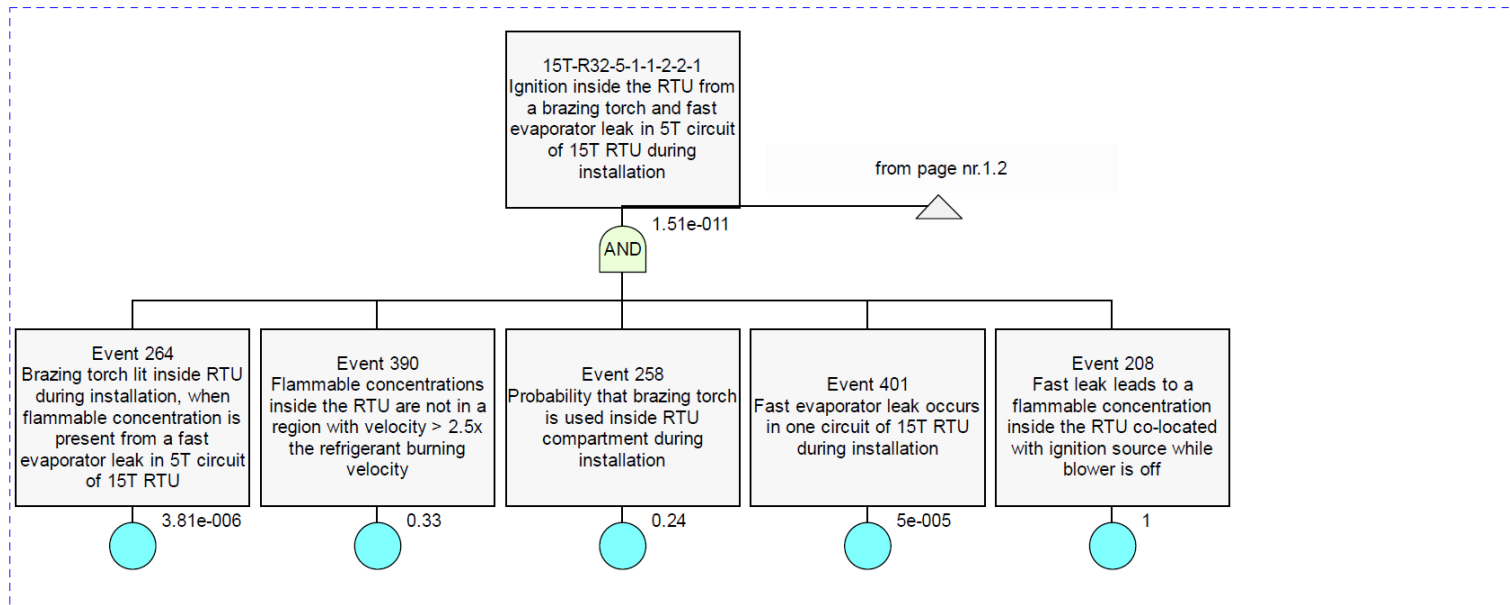

15T RTU Serving a Commercial Kitchen – Installation – Page 1.2.4

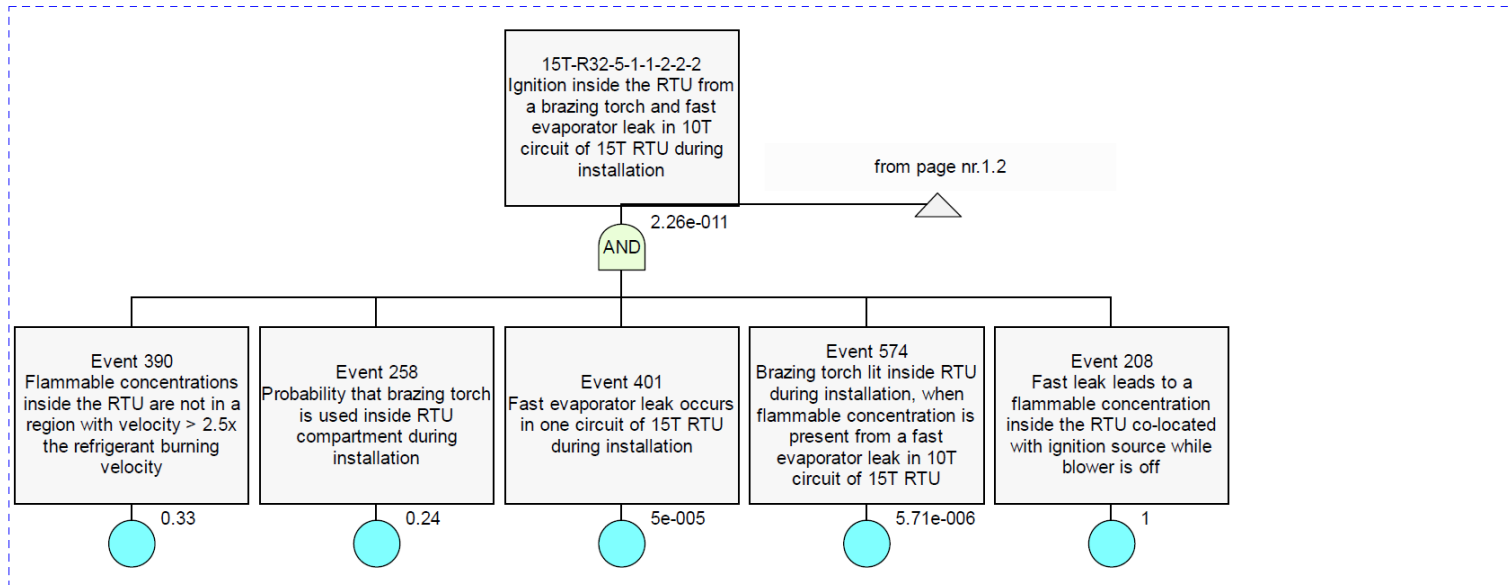

15T RTU Serving a Commercial Kitchen – Installation – Page 1.3

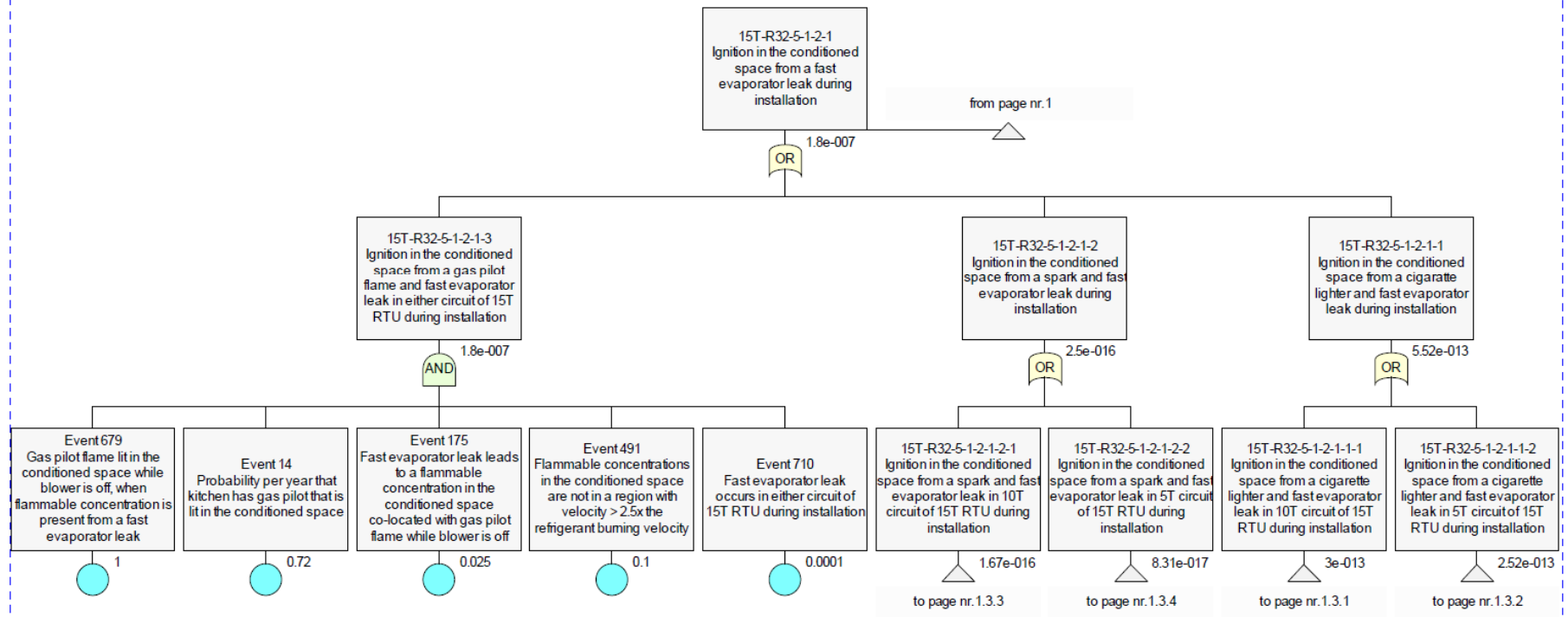

15T RTU Serving a Commercial Kitchen – Installation – Page 1.3.1

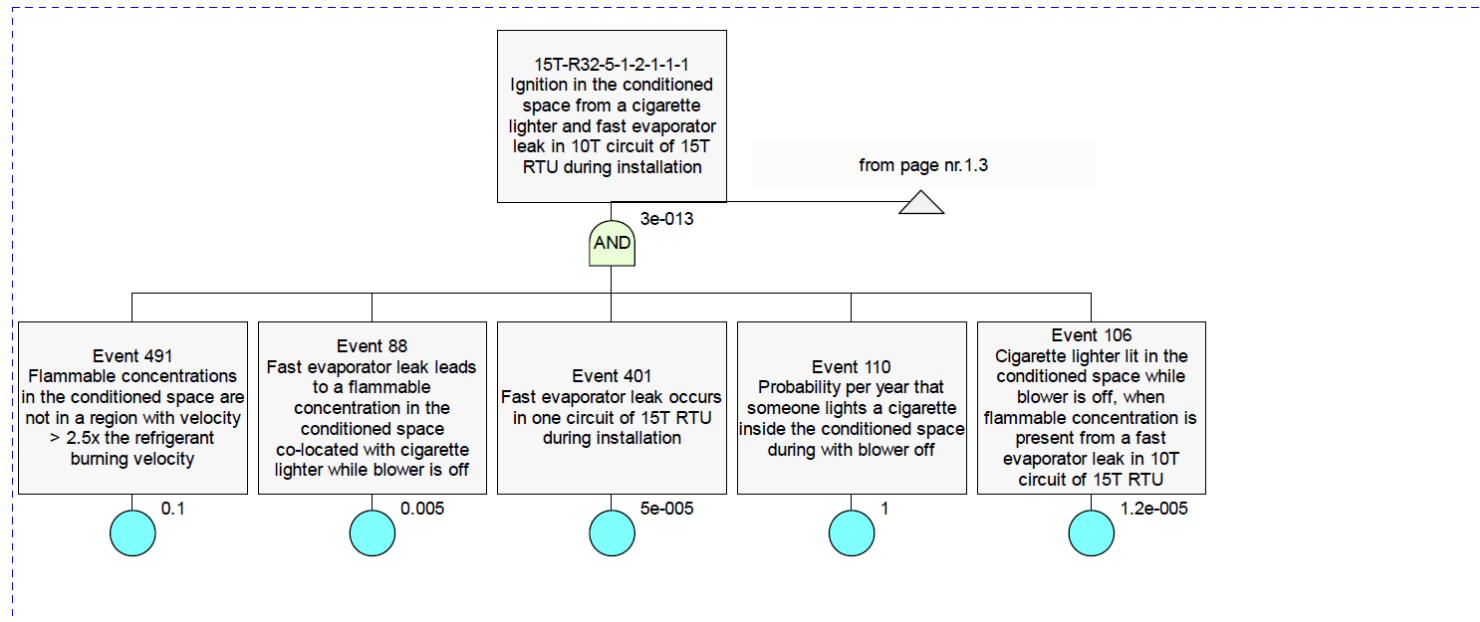

15T RTU Serving a Commercial Kitchen – Installation – Page 1.3.2

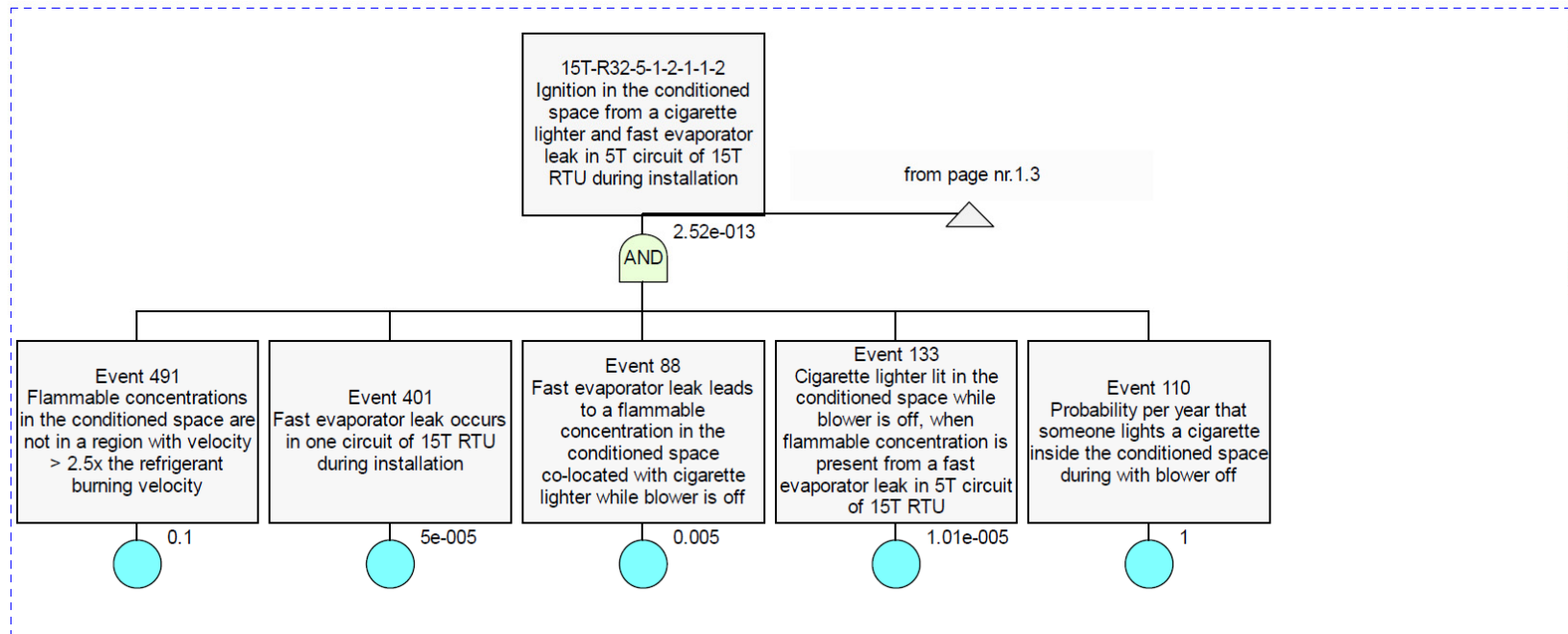

15T RTU Serving a Commercial Kitchen – Installation – Page 1.3.3

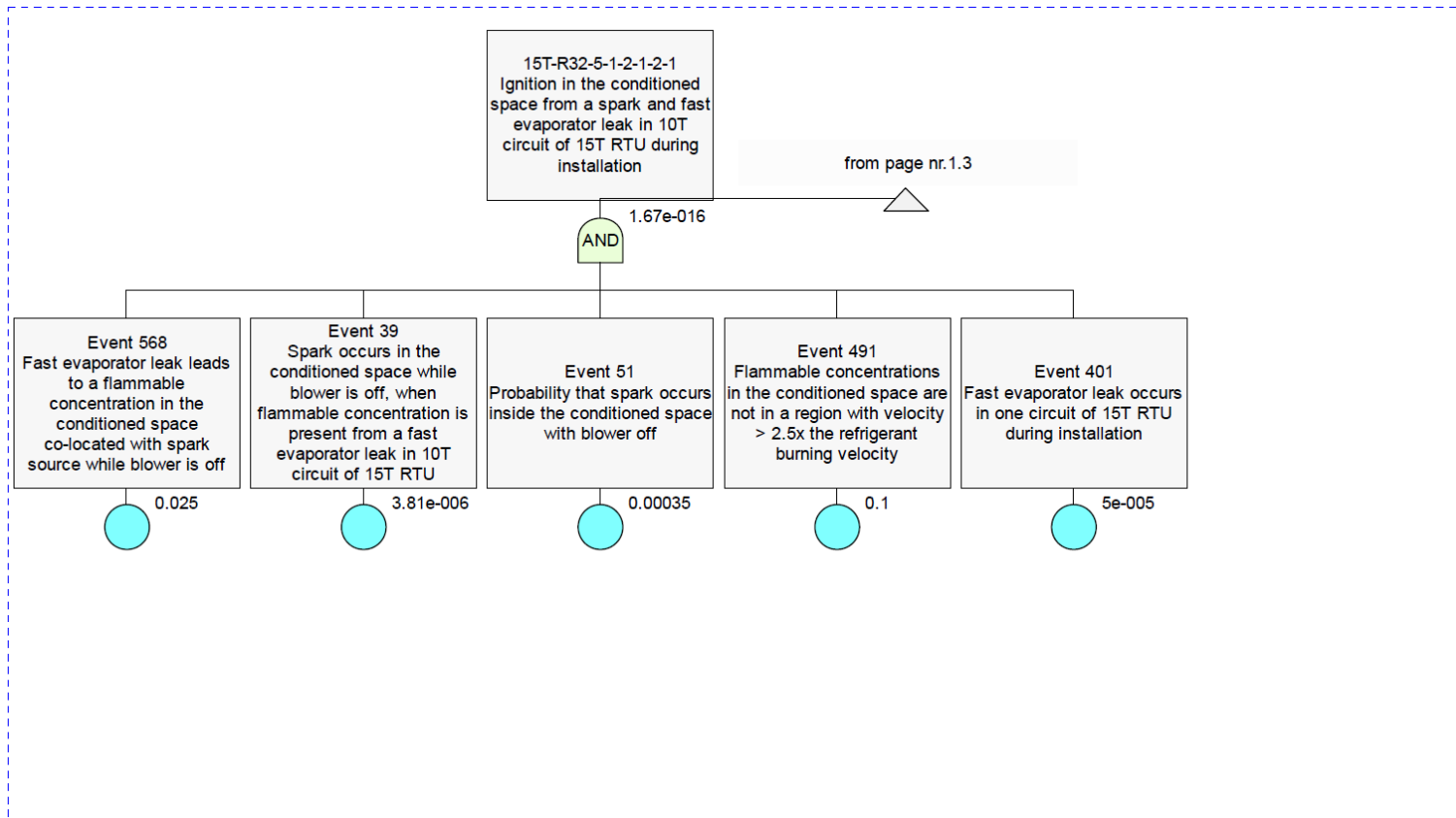

15T RTU Serving a Commercial Kitchen – Installation – Page 1.3.4

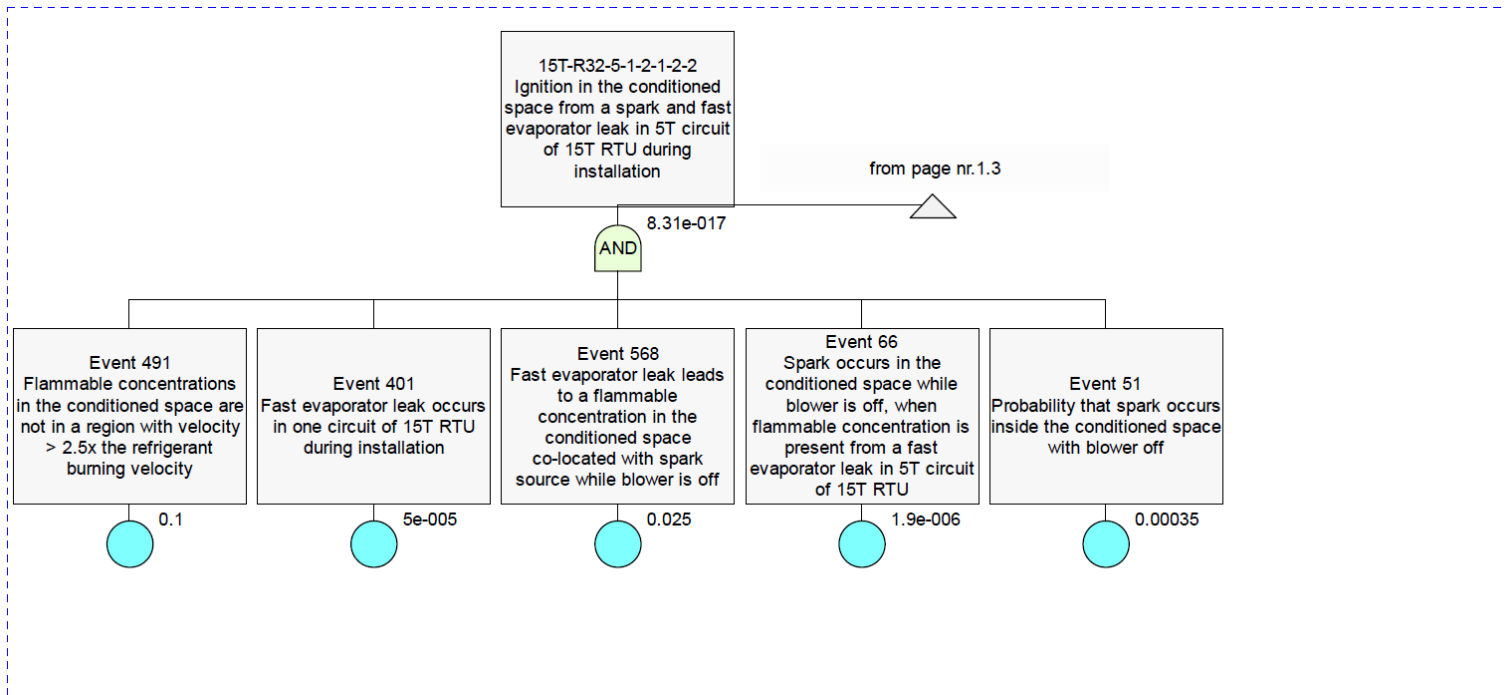

15T RTU Serving a Commercial Kitchen – Installation – Page 1.4

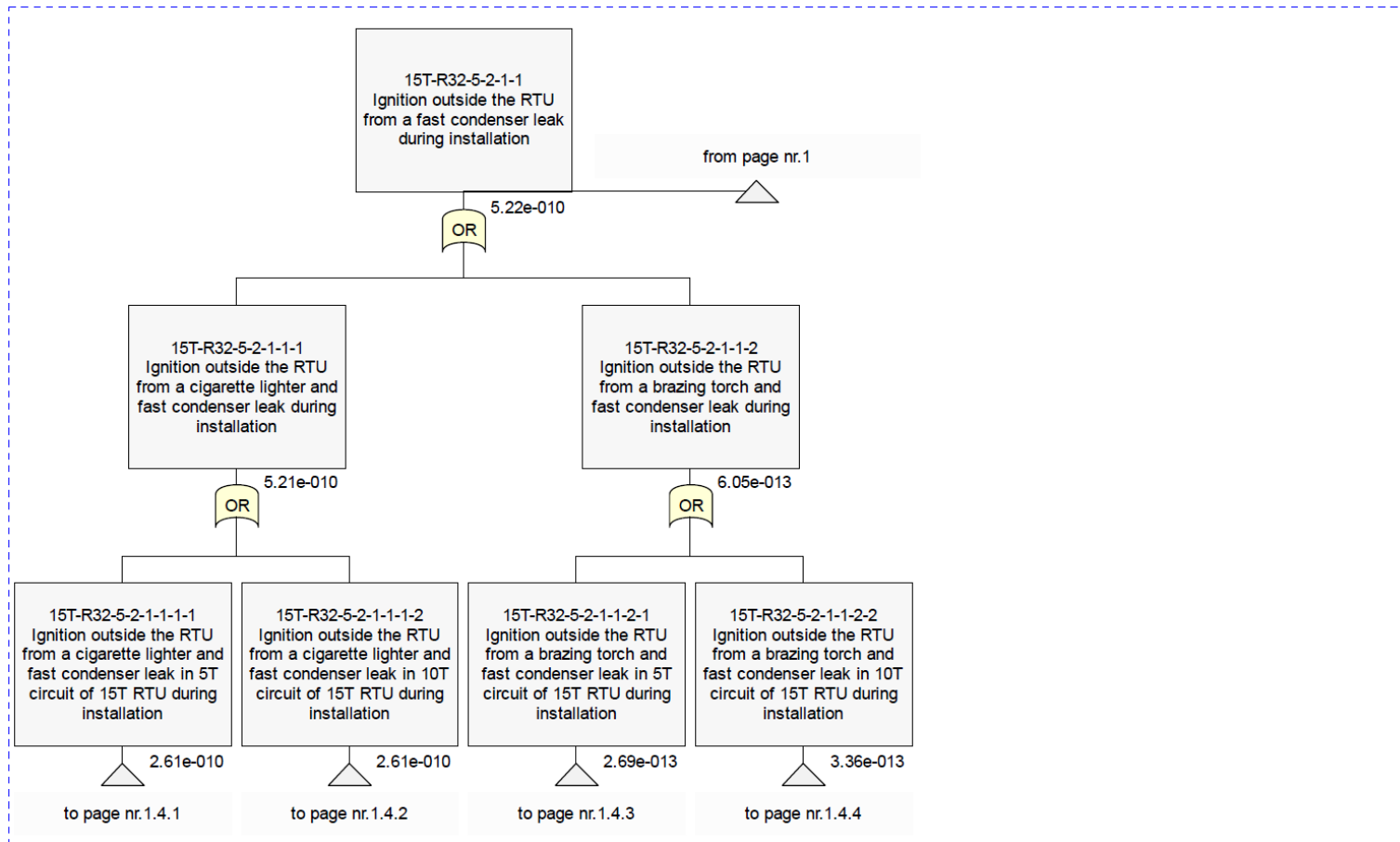

15T RTU Serving a Commercial Kitchen – Installation – Page 1.4.1

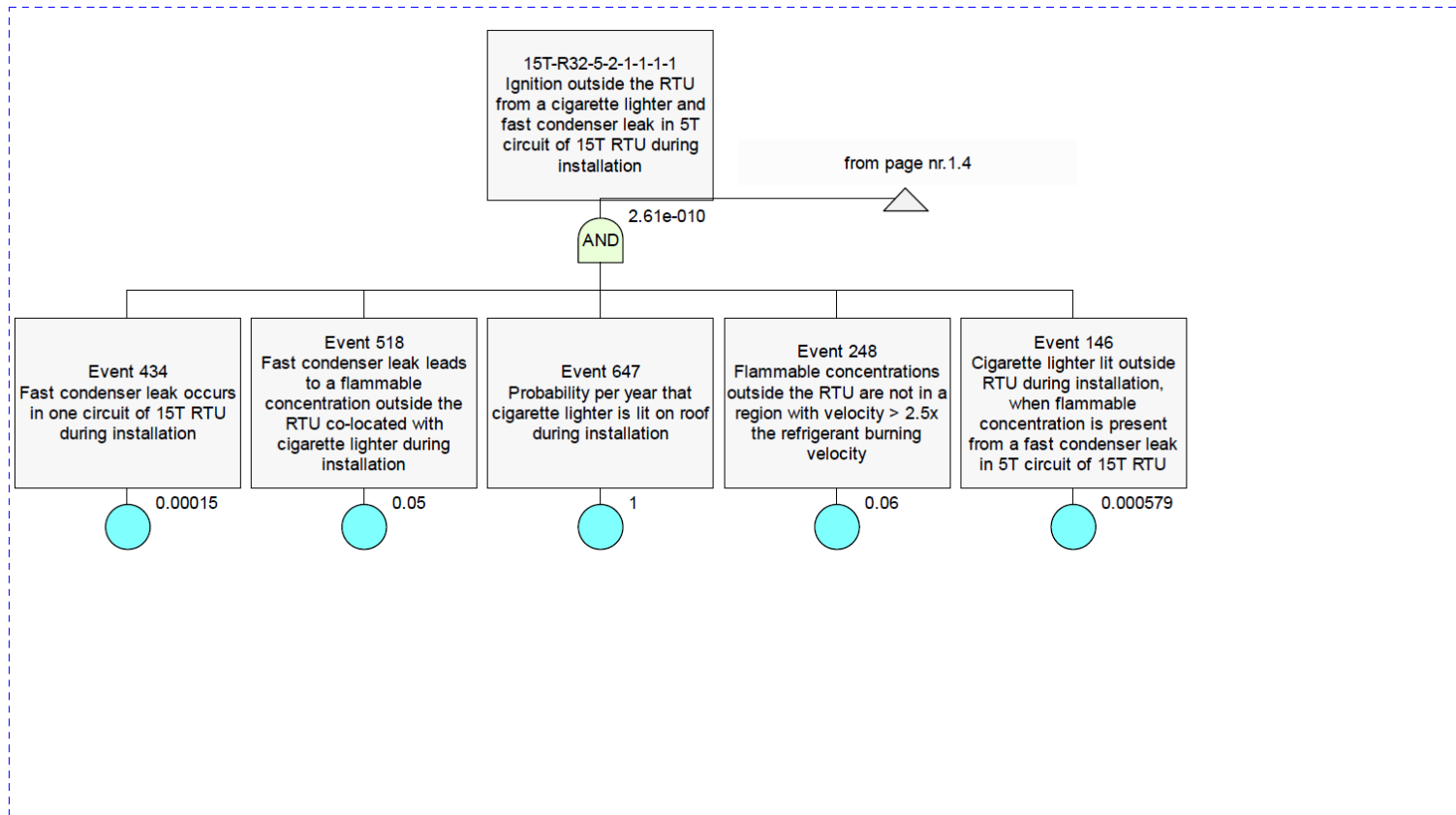

15T RTU Serving a Commercial Kitchen – Installation – Page 1.4.2

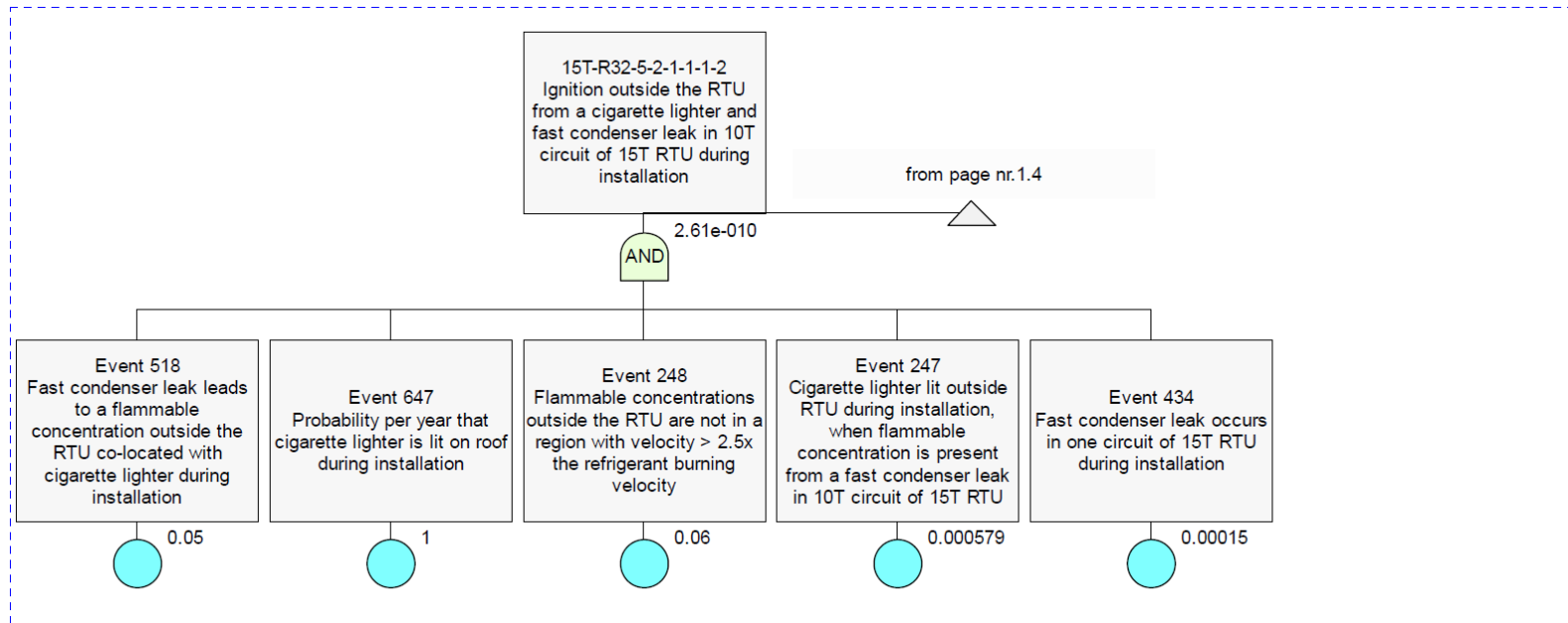

15T RTU Serving a Commercial Kitchen – Installation – Page 1.4.3

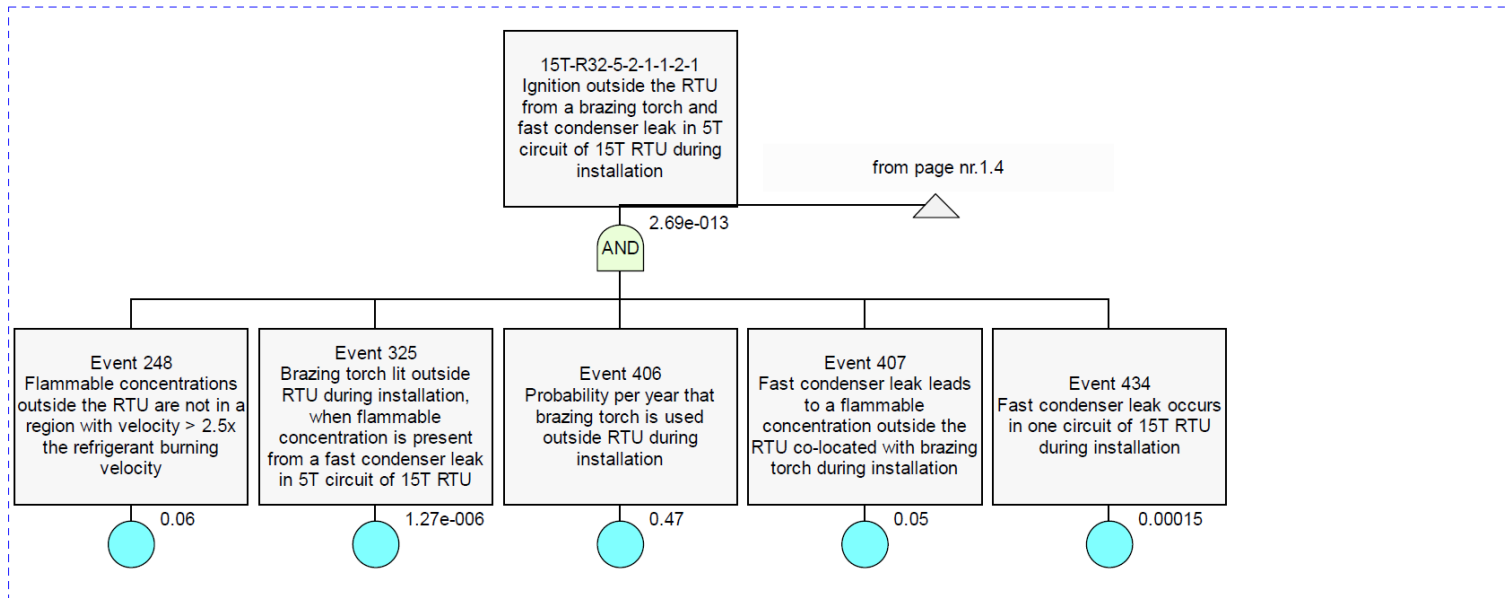

15T RTU Serving a Commercial Kitchen – Installation – Page 1.4.4

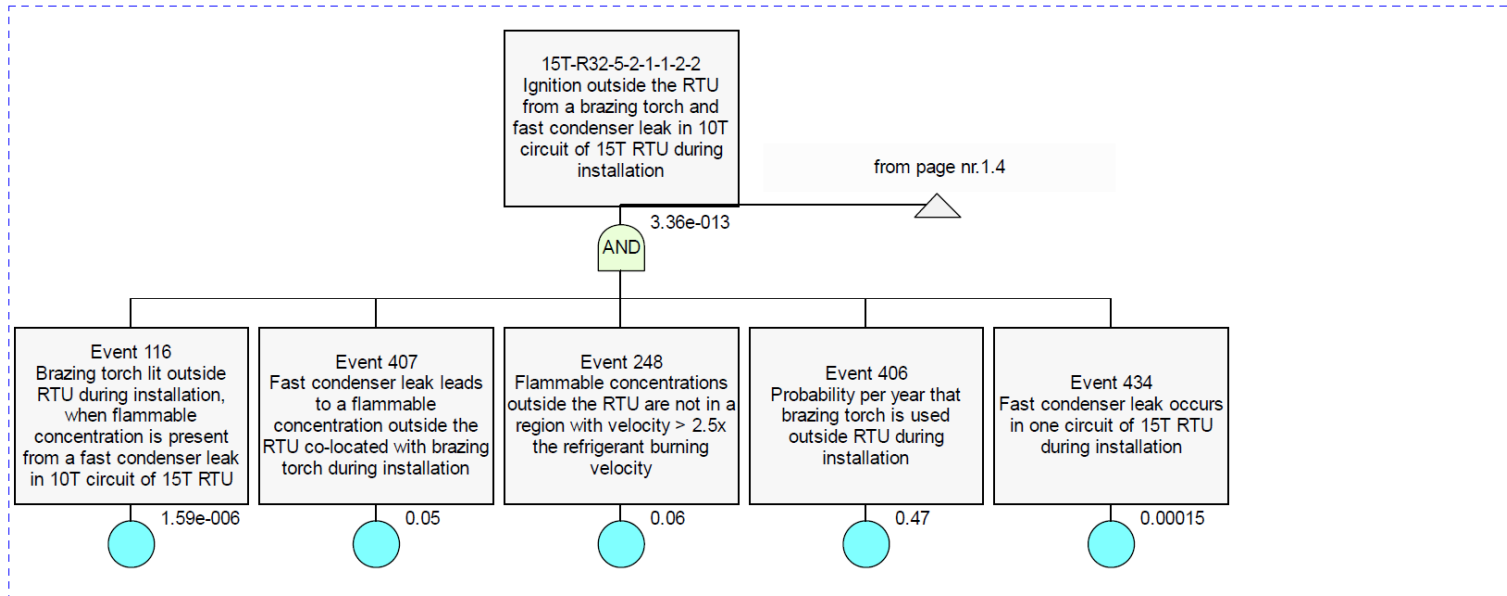

15T RTU Serving a Commercial Kitchen – Installation – Page 1.5

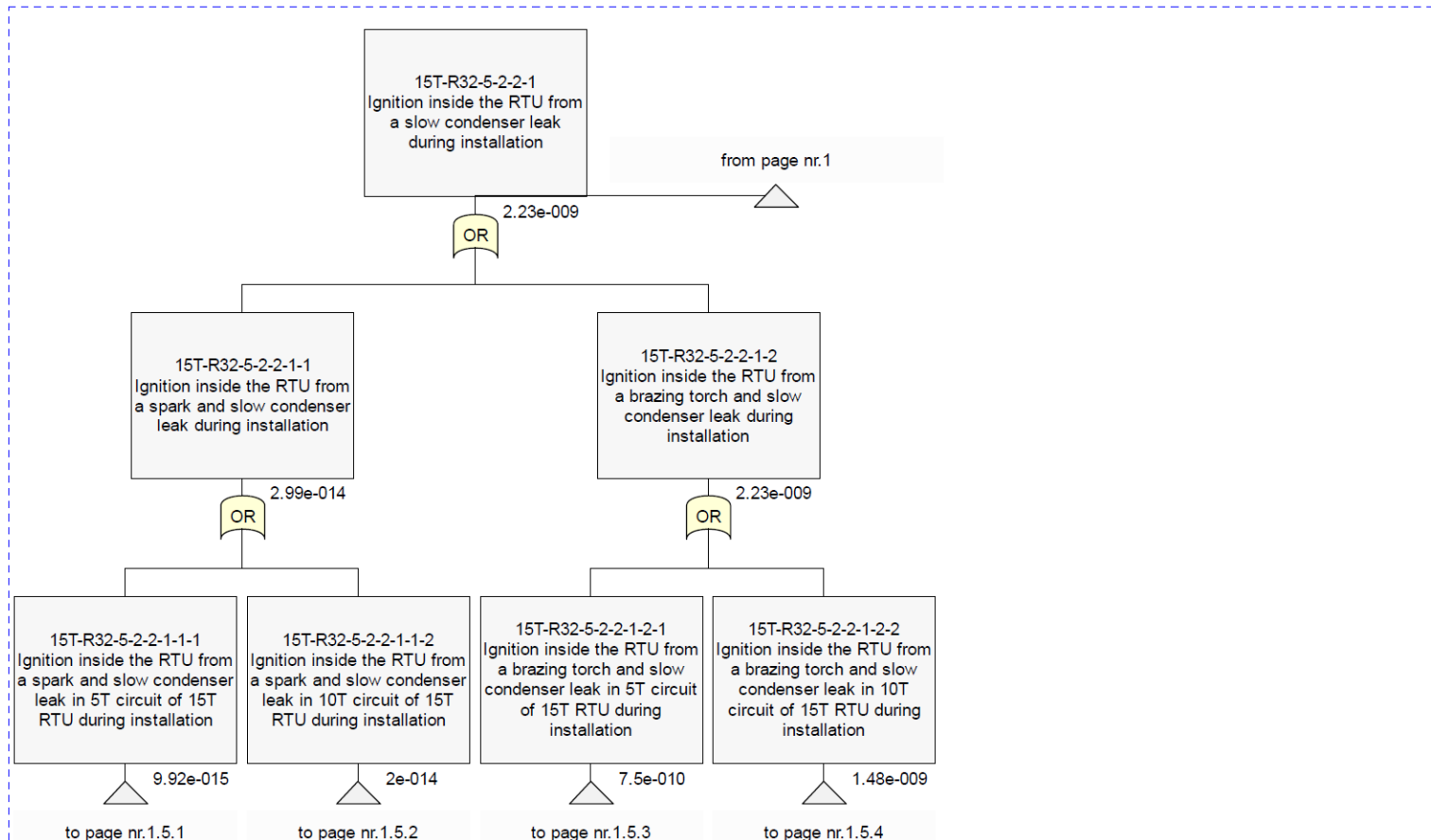

15T RTU Serving a Commercial Kitchen – Installation – Page 1.5.1

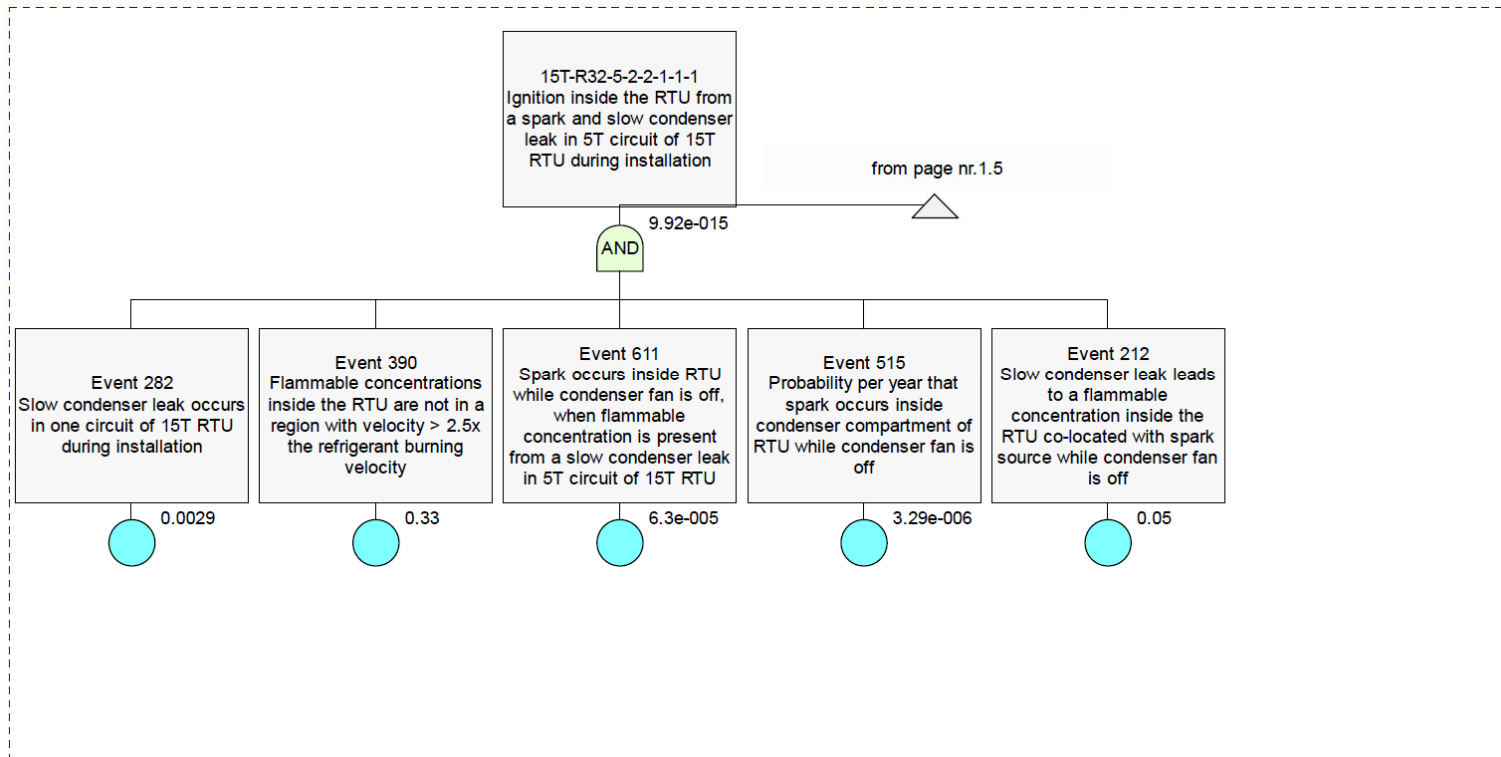

15T RTU Serving a Commercial Kitchen – Installation – Page 1.5.2

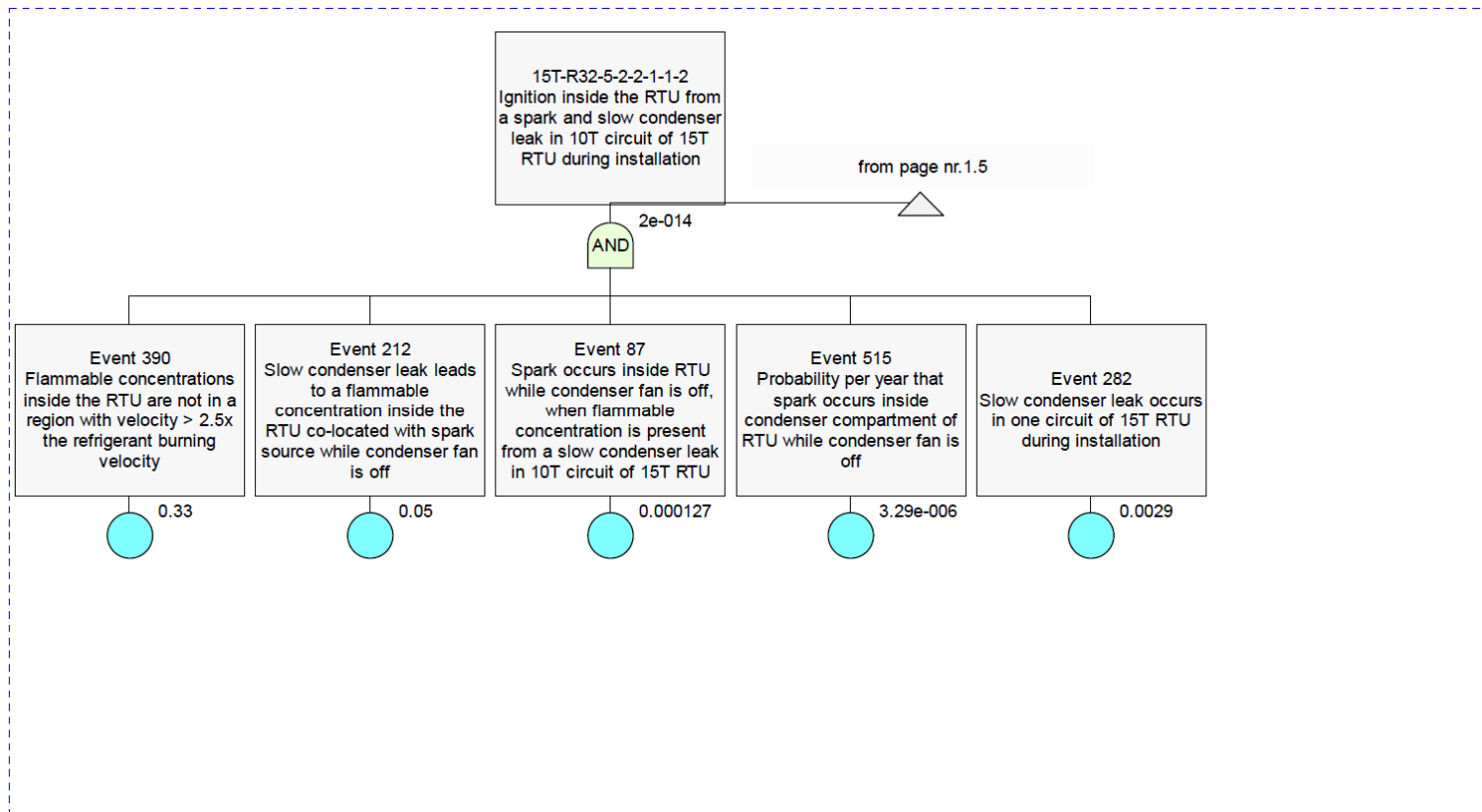

15T RTU Serving a Commercial Kitchen – Installation – Page 1.5.3

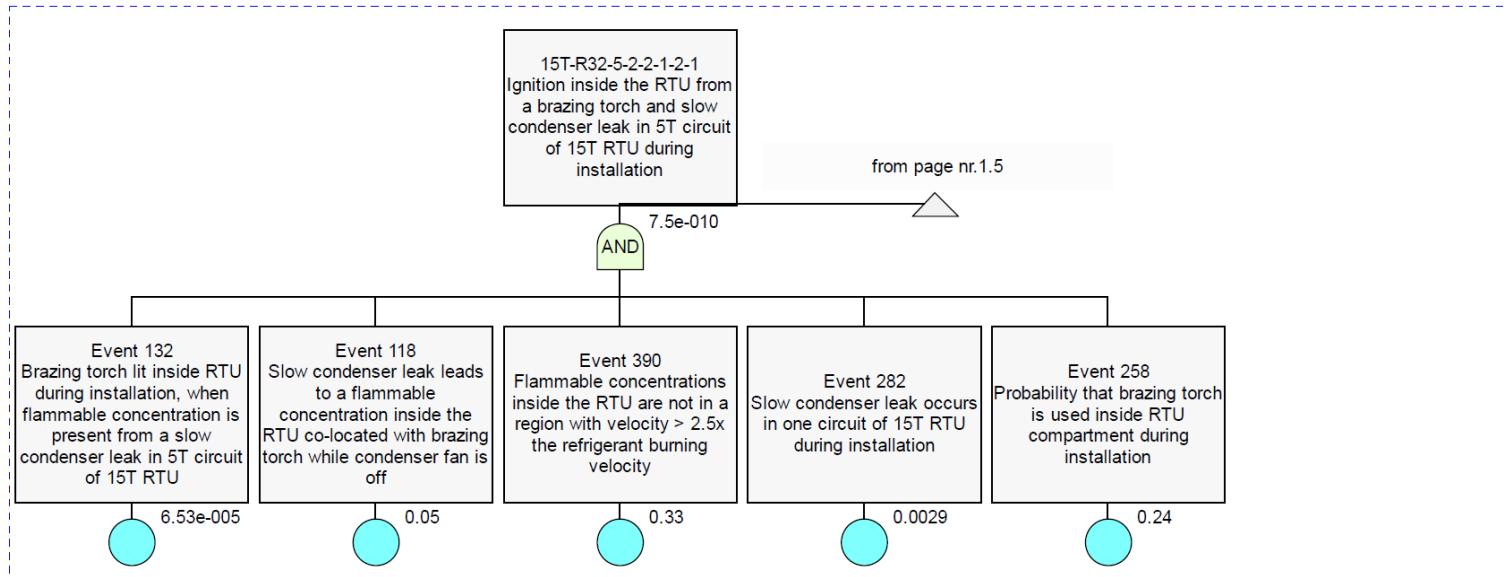

15T RTU Serving a Commercial Kitchen – Installation – Page 1.5.4

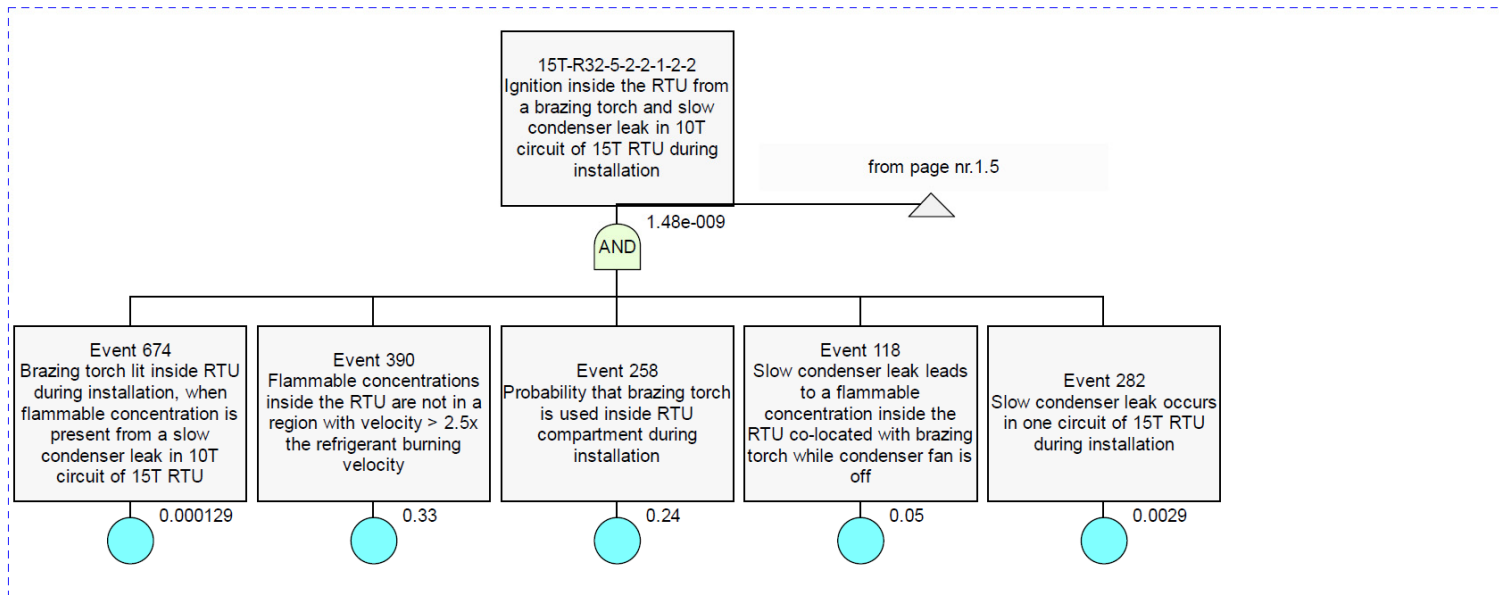

15T RTU Serving a Commercial Kitchen – Installation – Page 1.6

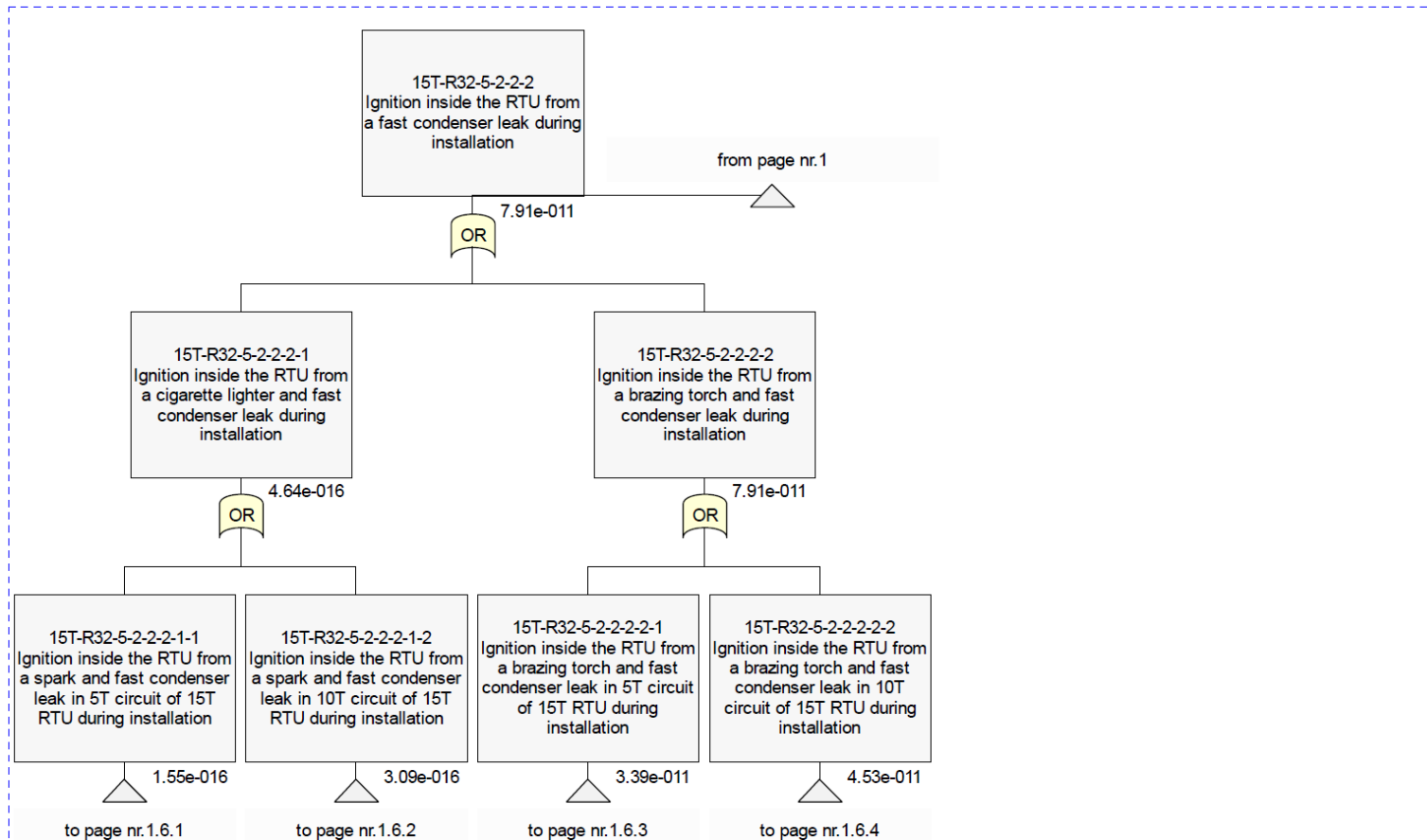

15T RTU Serving a Commercial Kitchen – Installation – Page 1.6.1

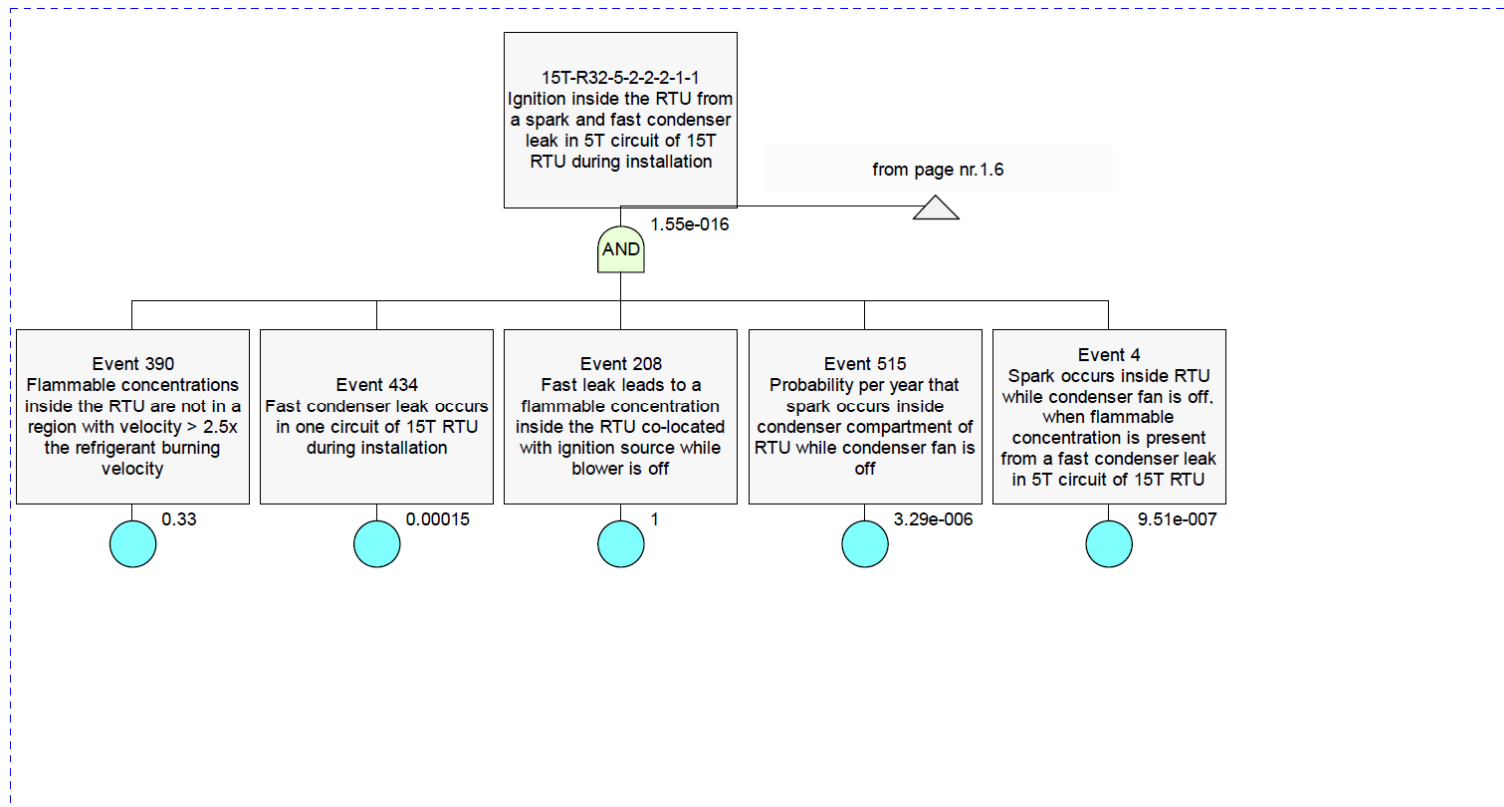

15T RTU Serving a Commercial Kitchen – Installation – Page 1.6.2

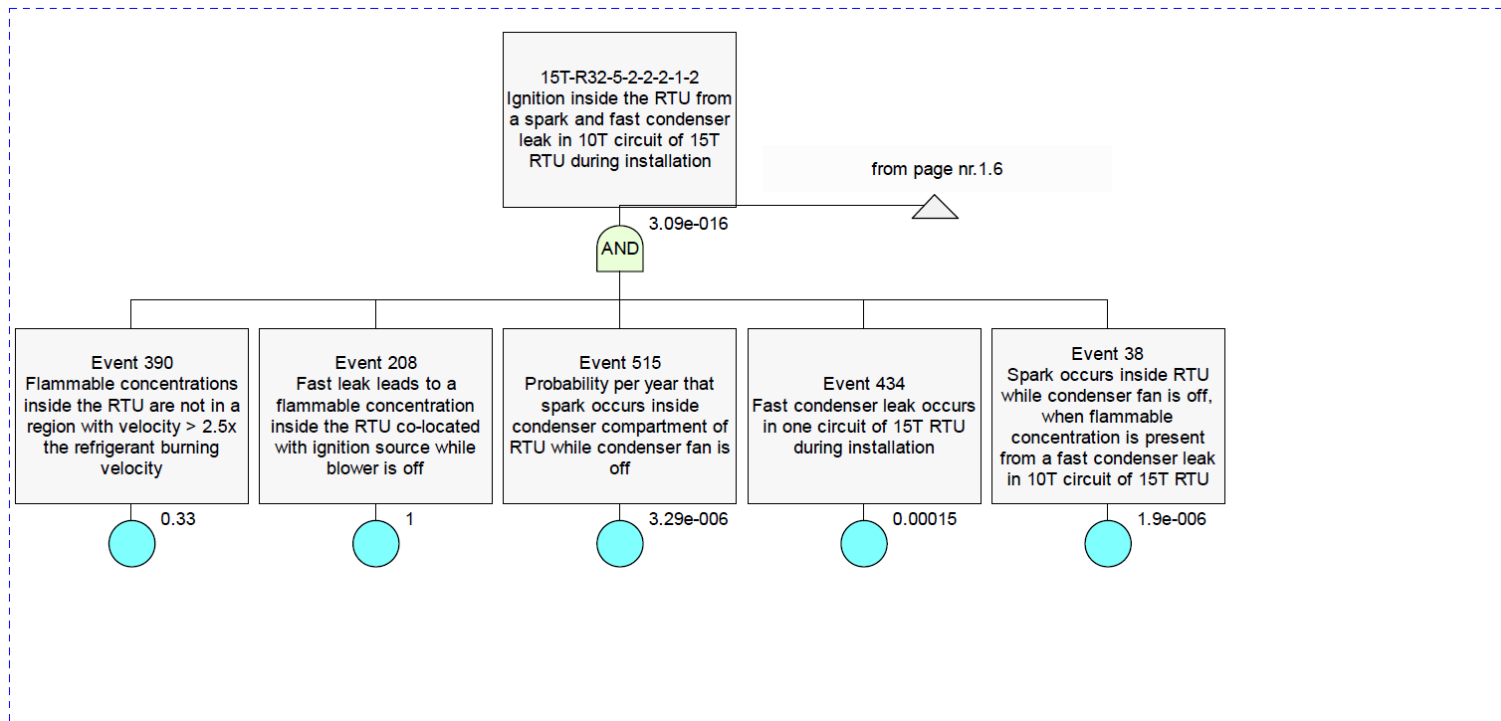

15T RTU Serving a Commercial Kitchen – Installation – Page 1.6.3

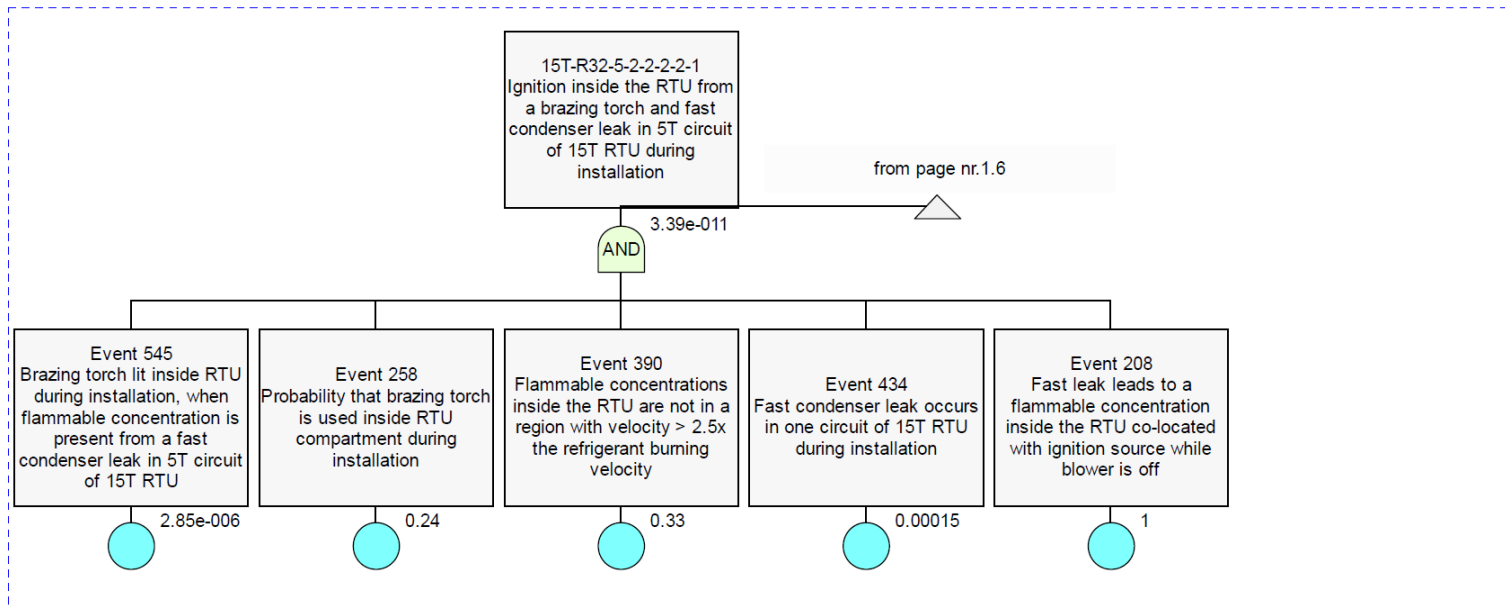

15T RTU Serving a Commercial Kitchen – Installation – Page 1.6.4

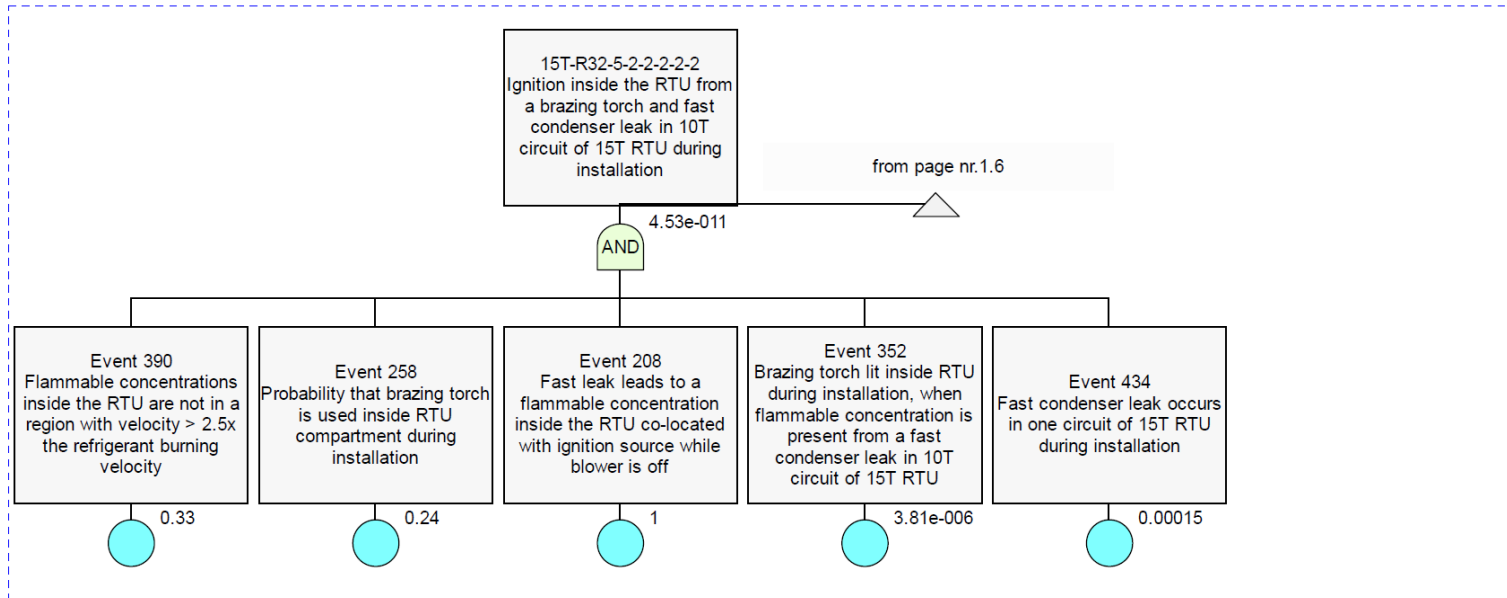

A.2 Fault Trees for Scenario C – 25T RTU Serving an Office

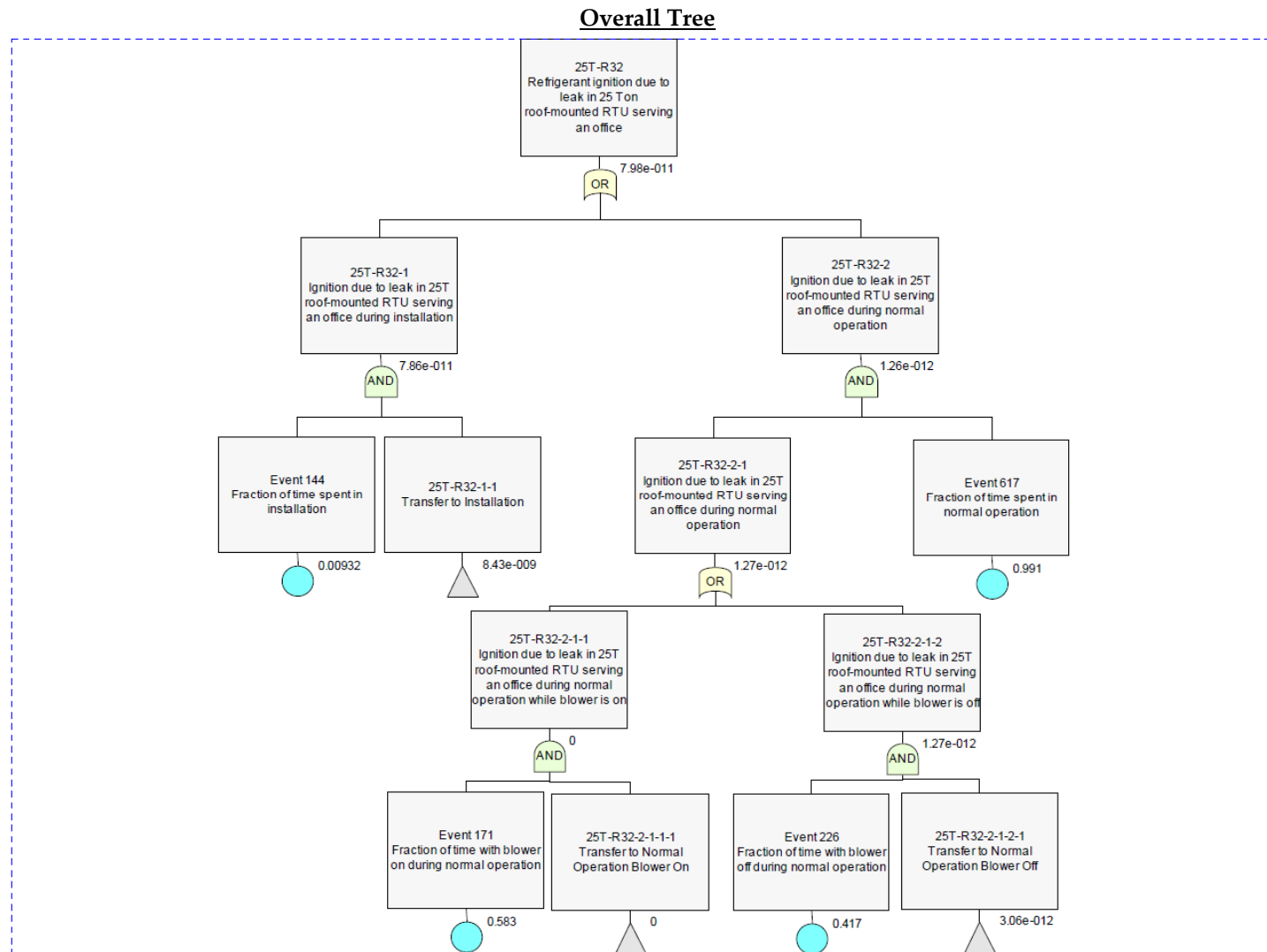

25T RTU Serving an Office – Normal Operation with Blower Off – Page 1

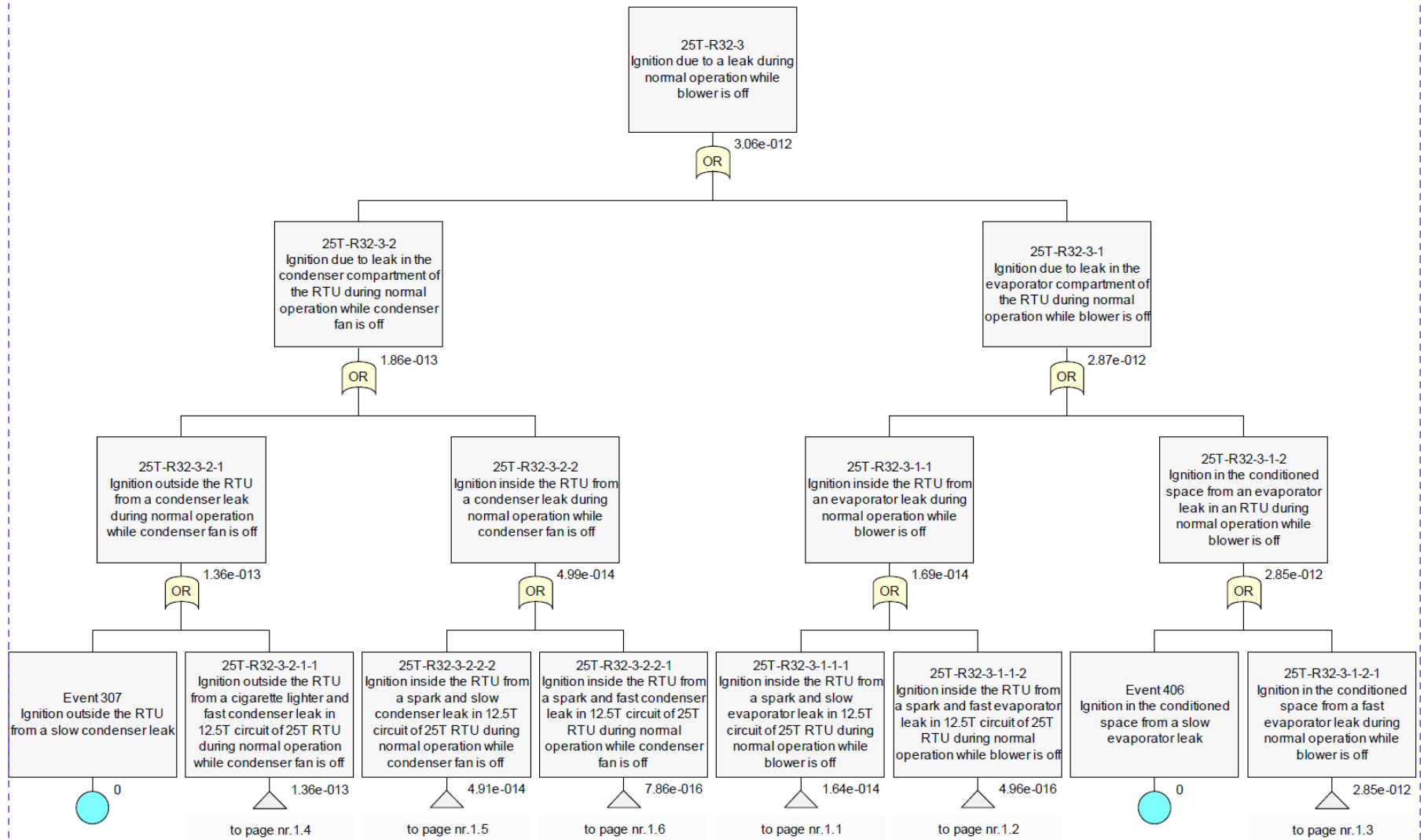

25T RTU Serving an Office – Normal Operation with Blower Off – Page 1.1

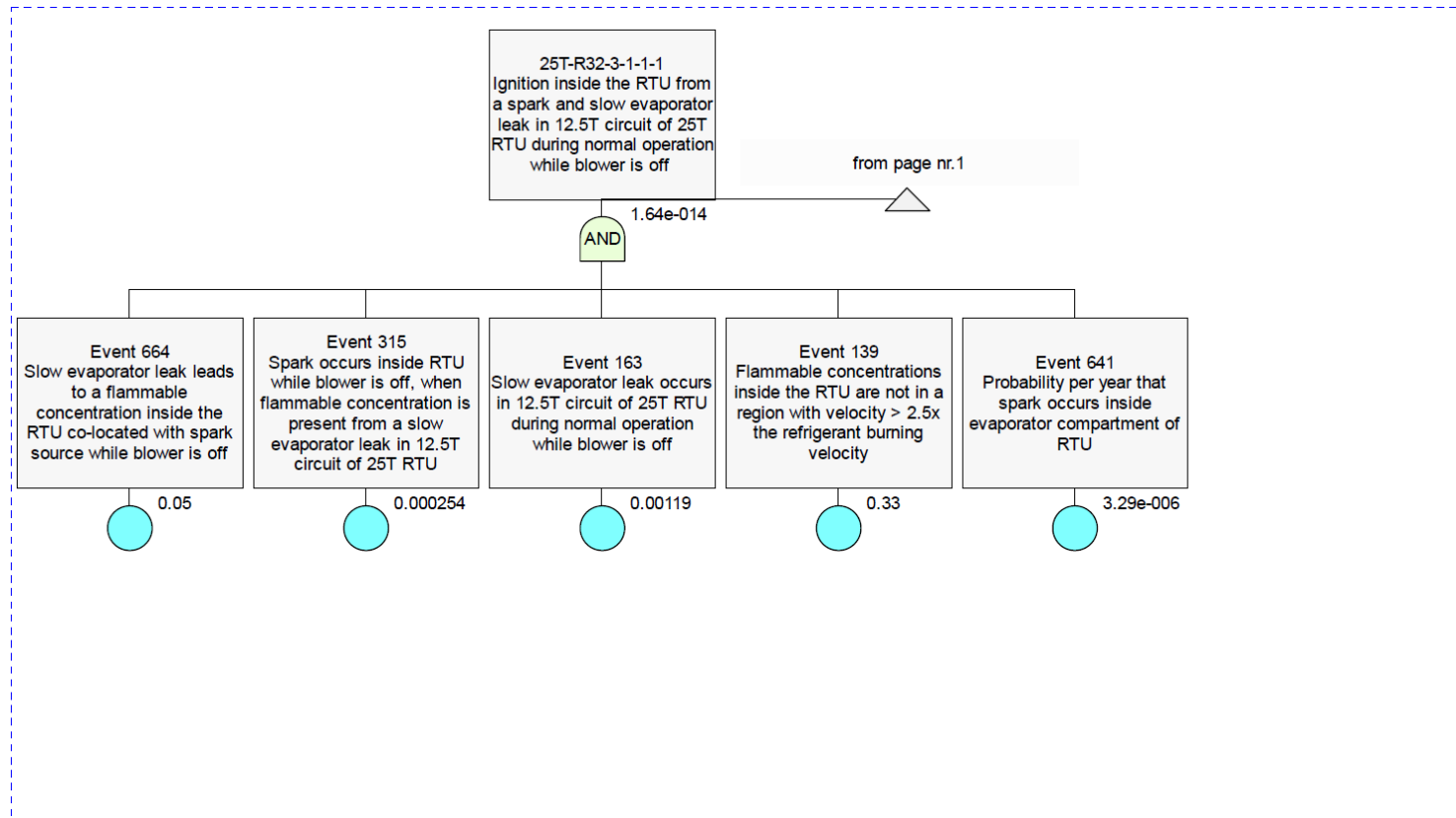

25T RTU Serving an Office – Normal Operation with Blower Off – Page 1.2

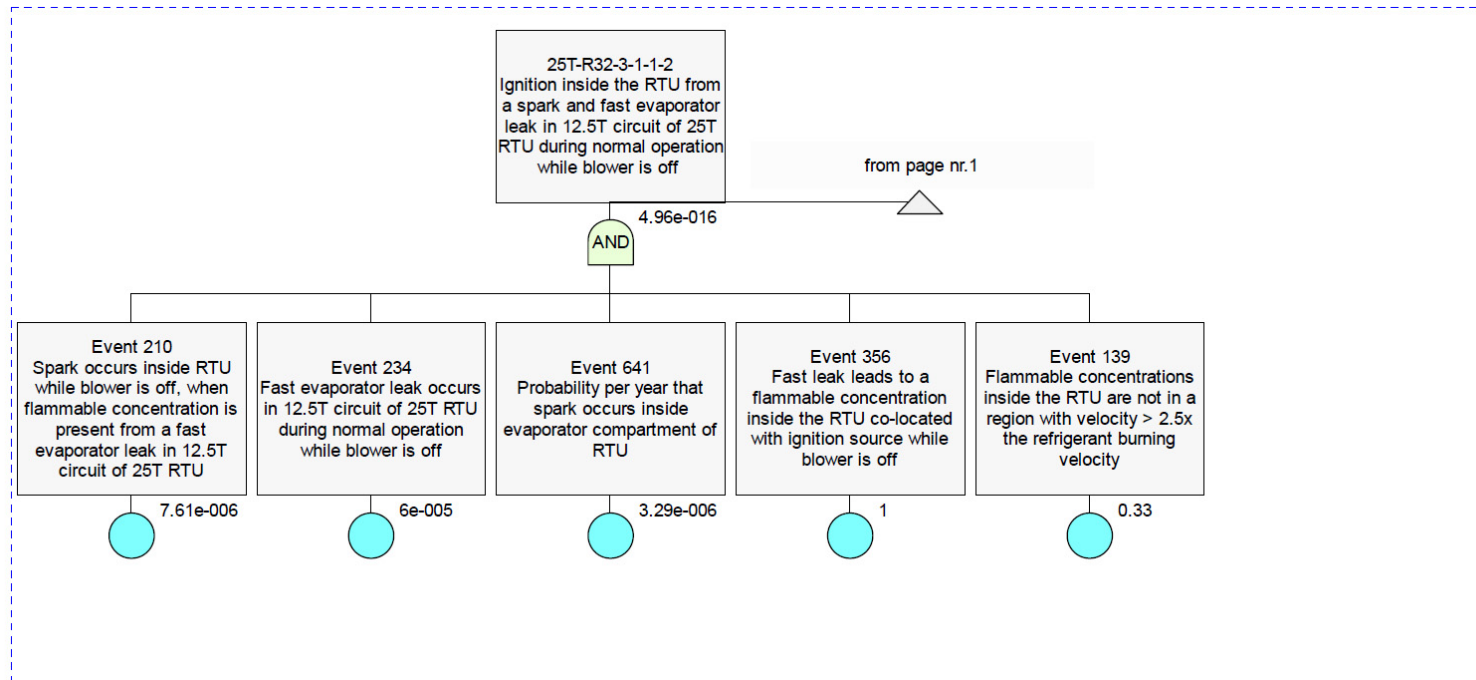

25T RTU Serving an Office – Normal Operation with Blower Off – Page 1.3

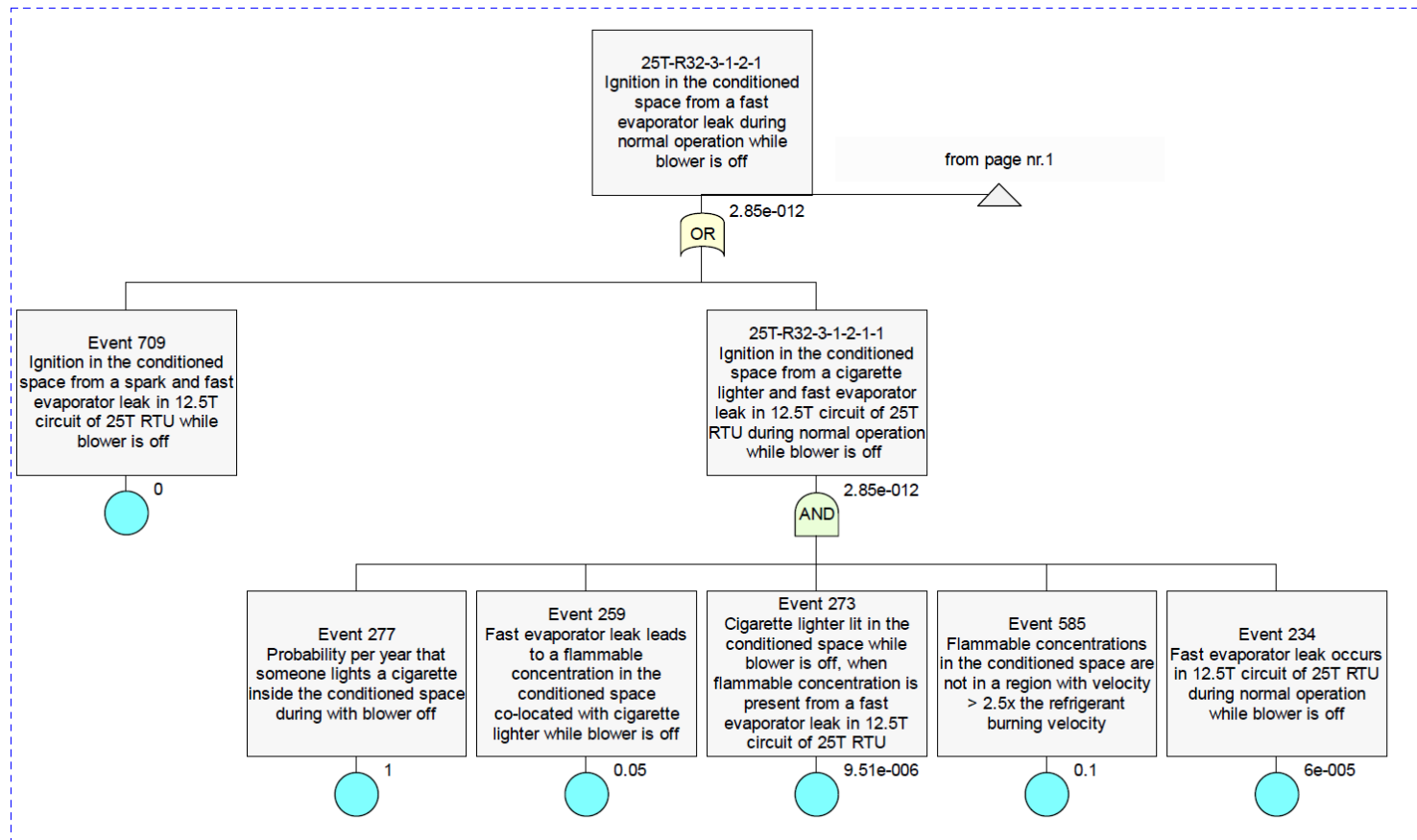

25T RTU Serving an Office – Normal Operation with Blower Off – Page 1.4

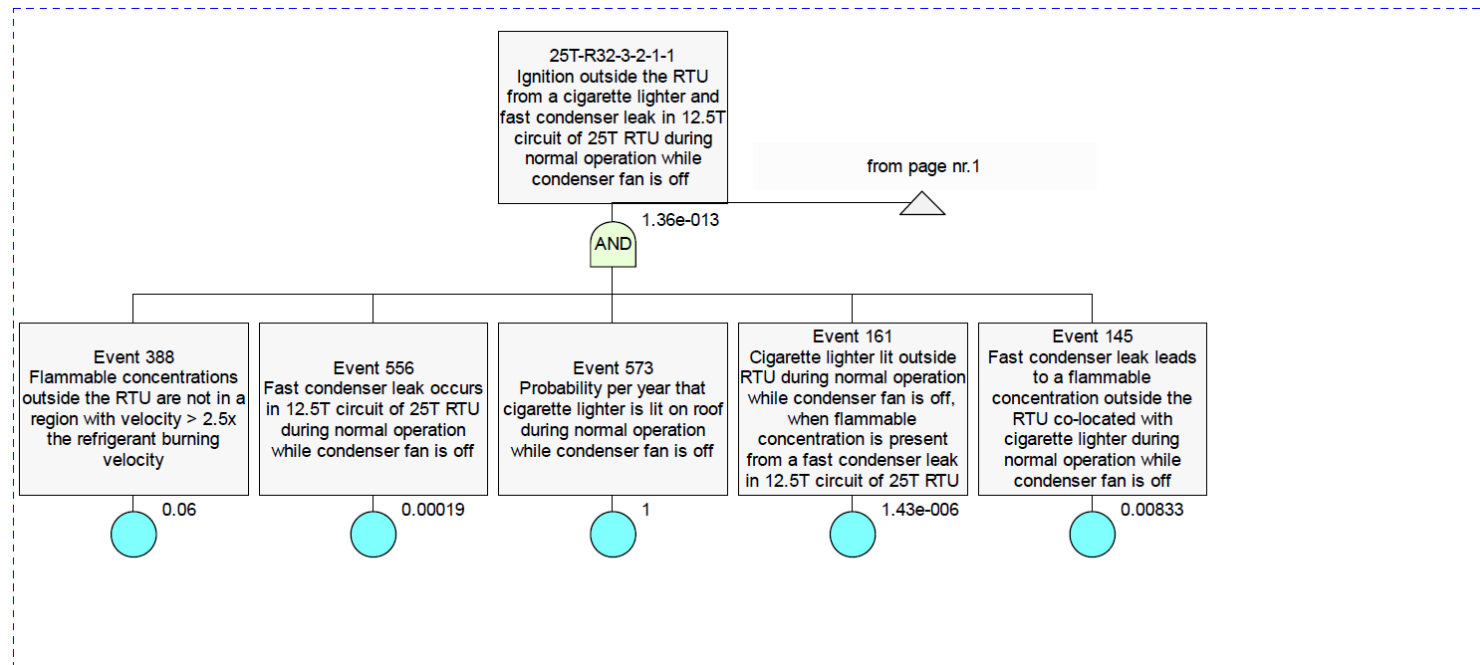

25T RTU Serving an Office – Normal Operation with Blower Off – Page 1.5

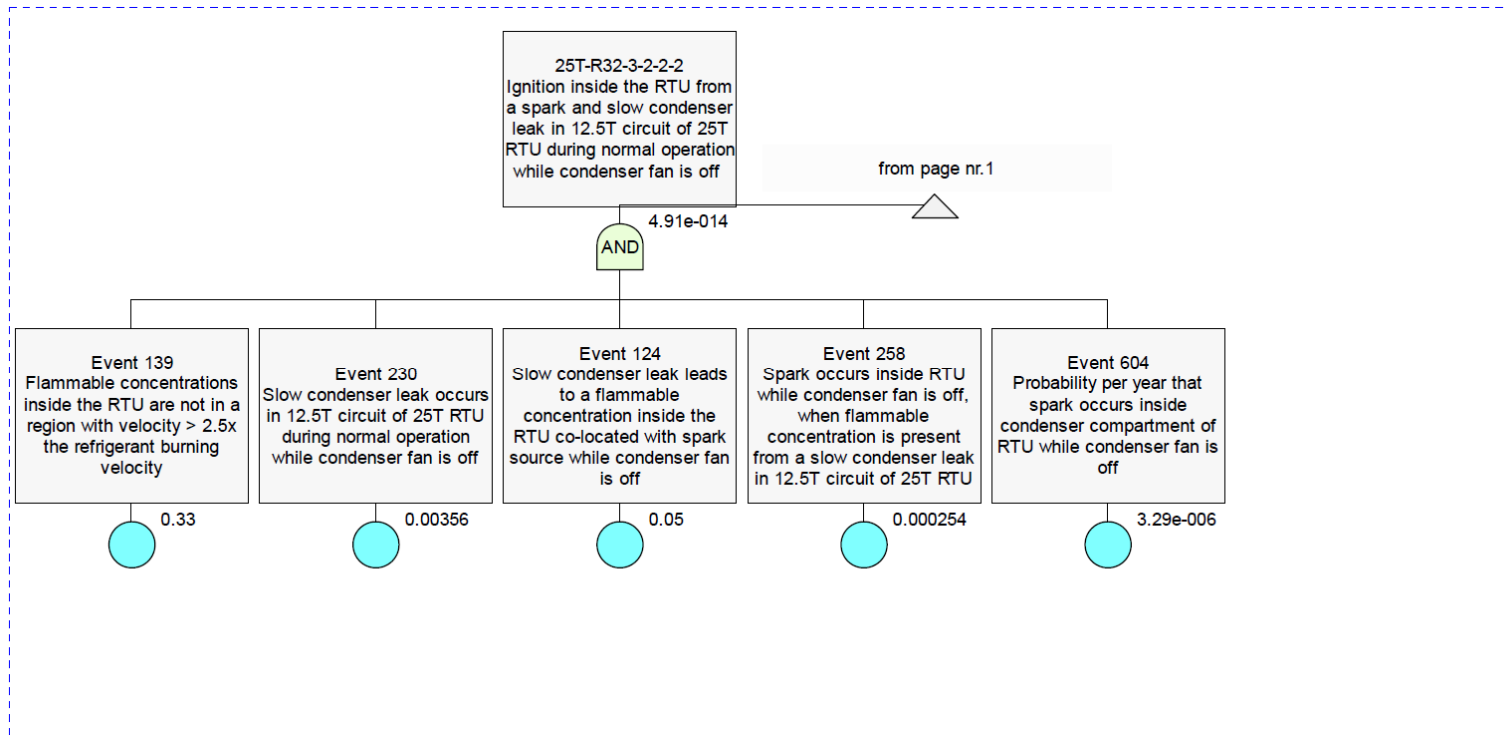

25T RTU Serving an Office – Normal Operation with Blower Off – Page 1.6

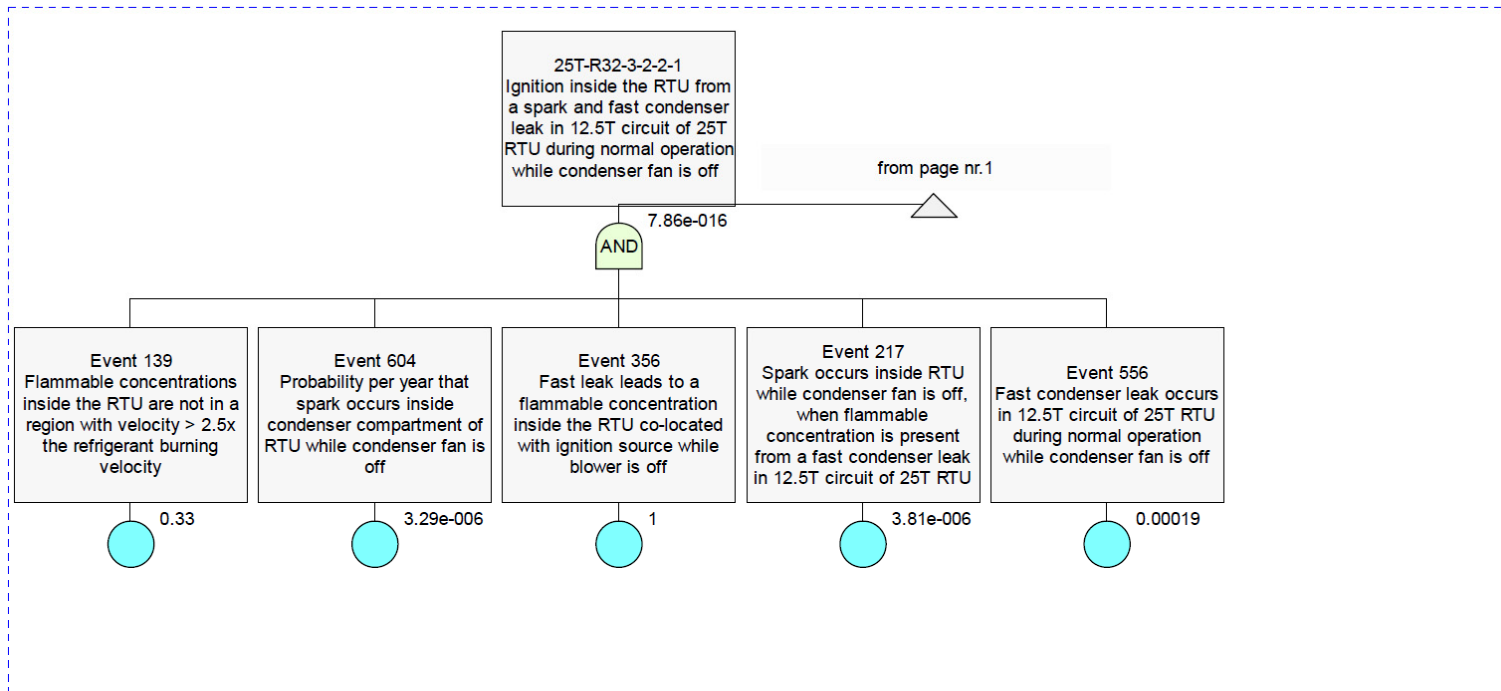

25T RTU Serving an Office – Normal Operation with Blower On

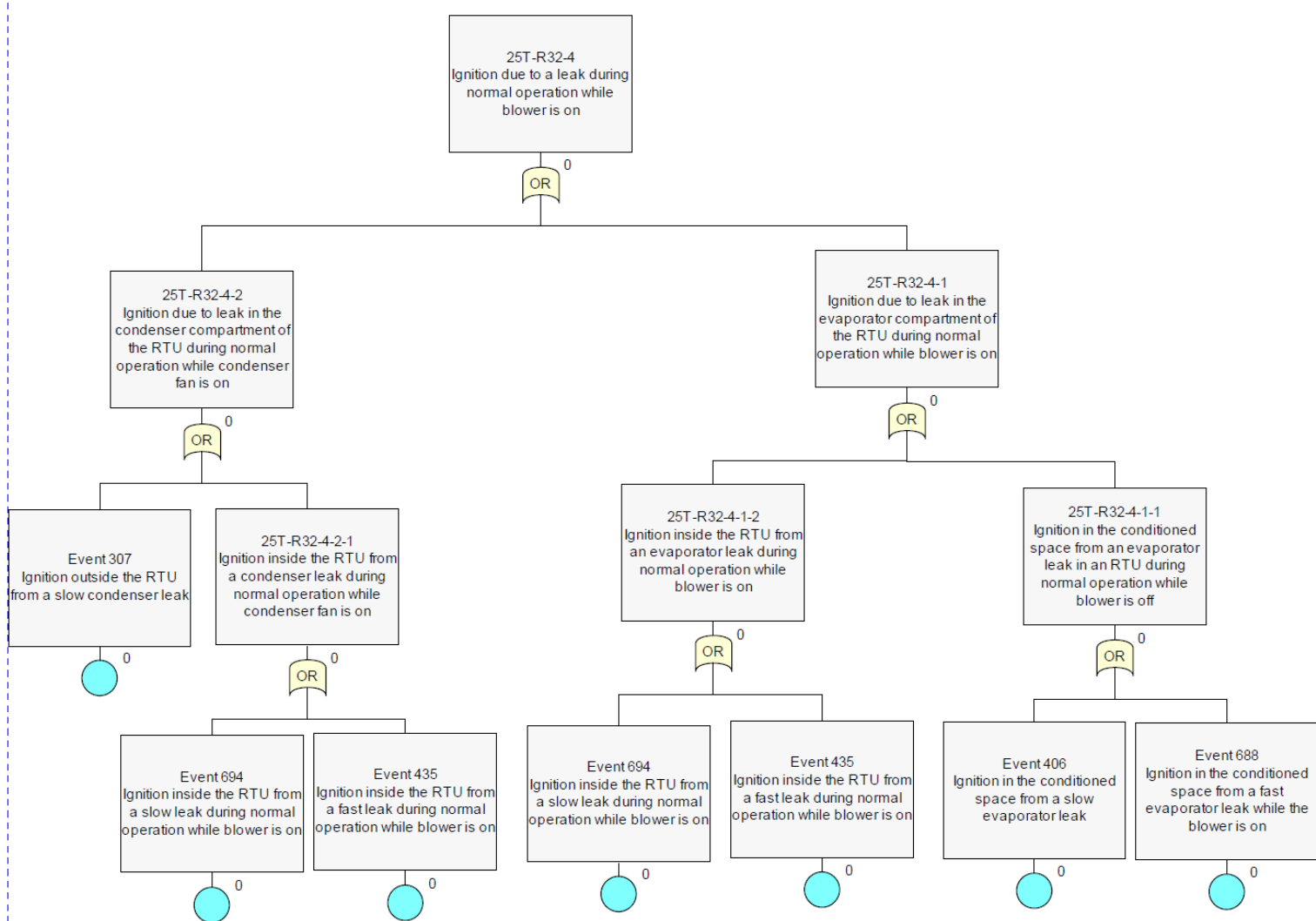

25T RTU Serving an Office – Installation – Page 1

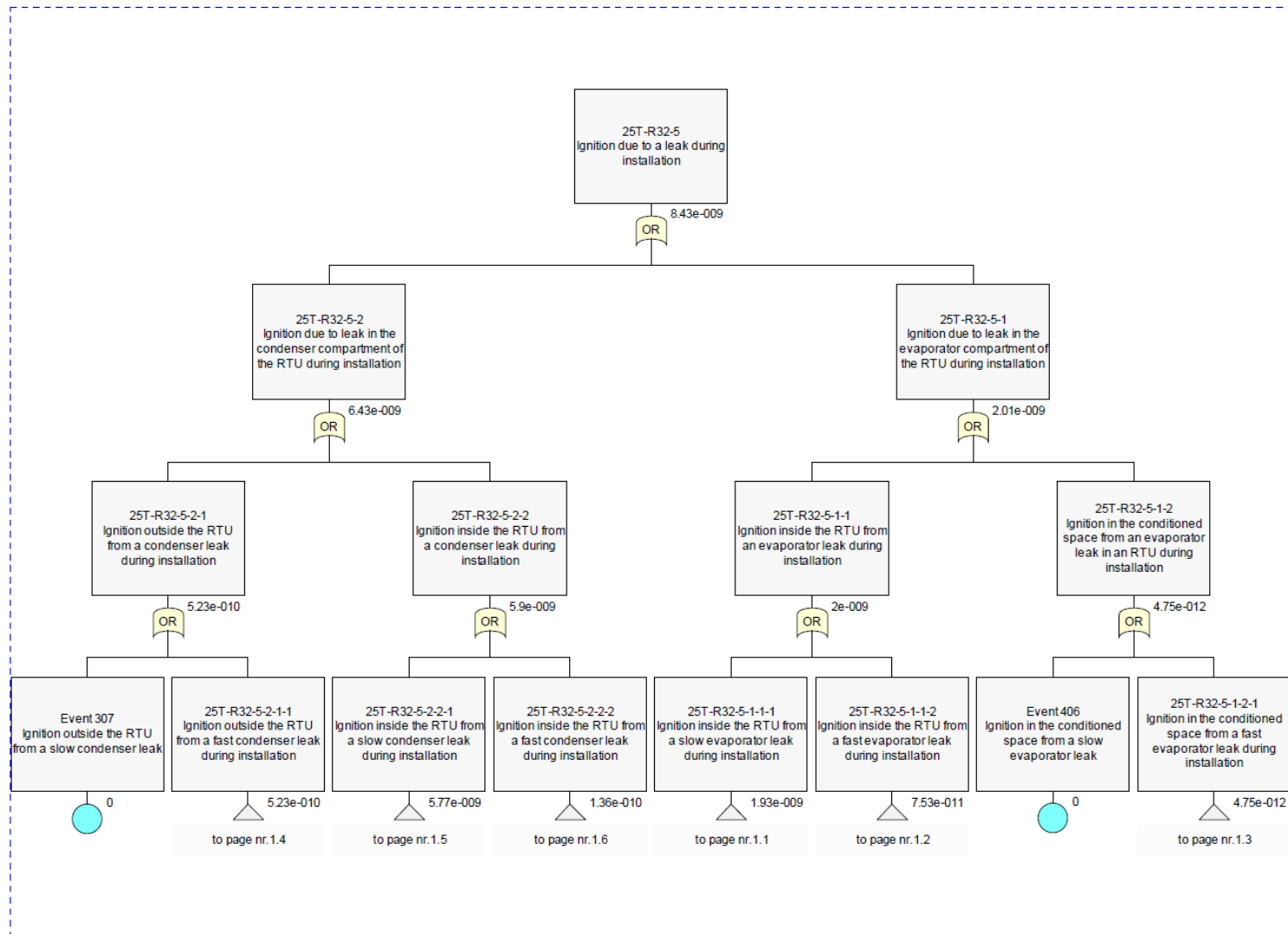

25T RTU Serving an Office – Installation – Page 1.1

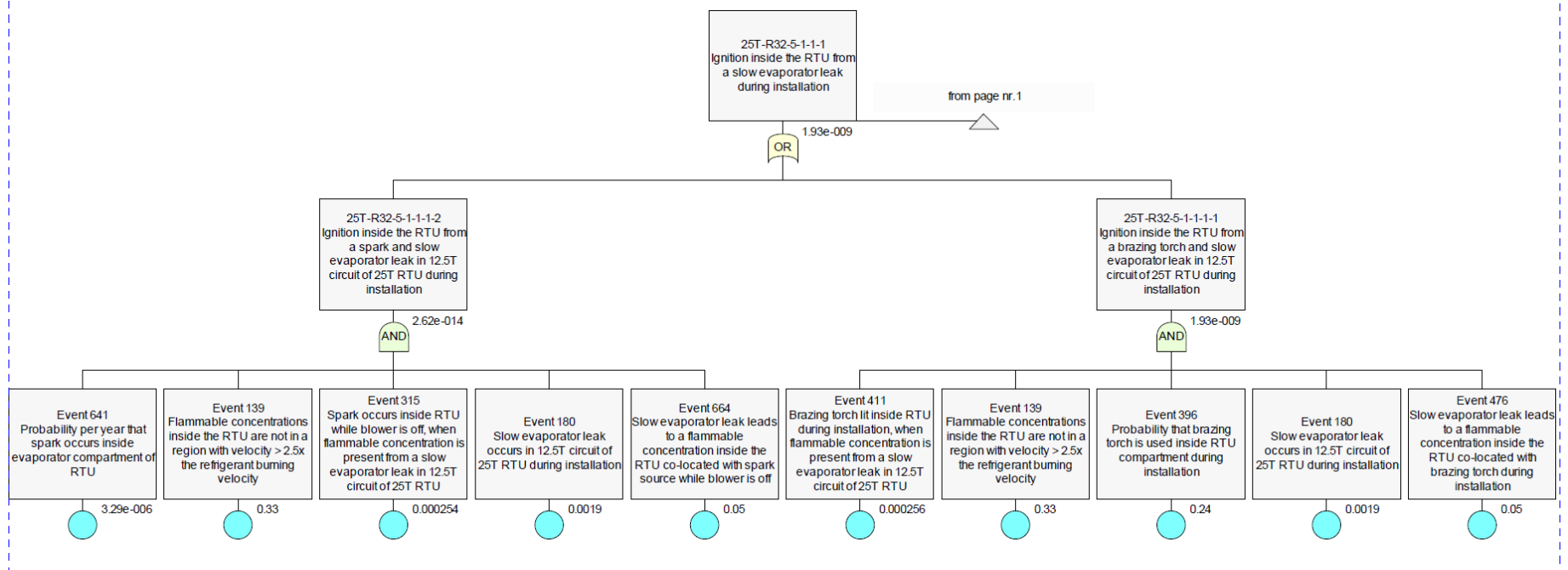

25T RTU Serving an Office – Installation – Page 1.2

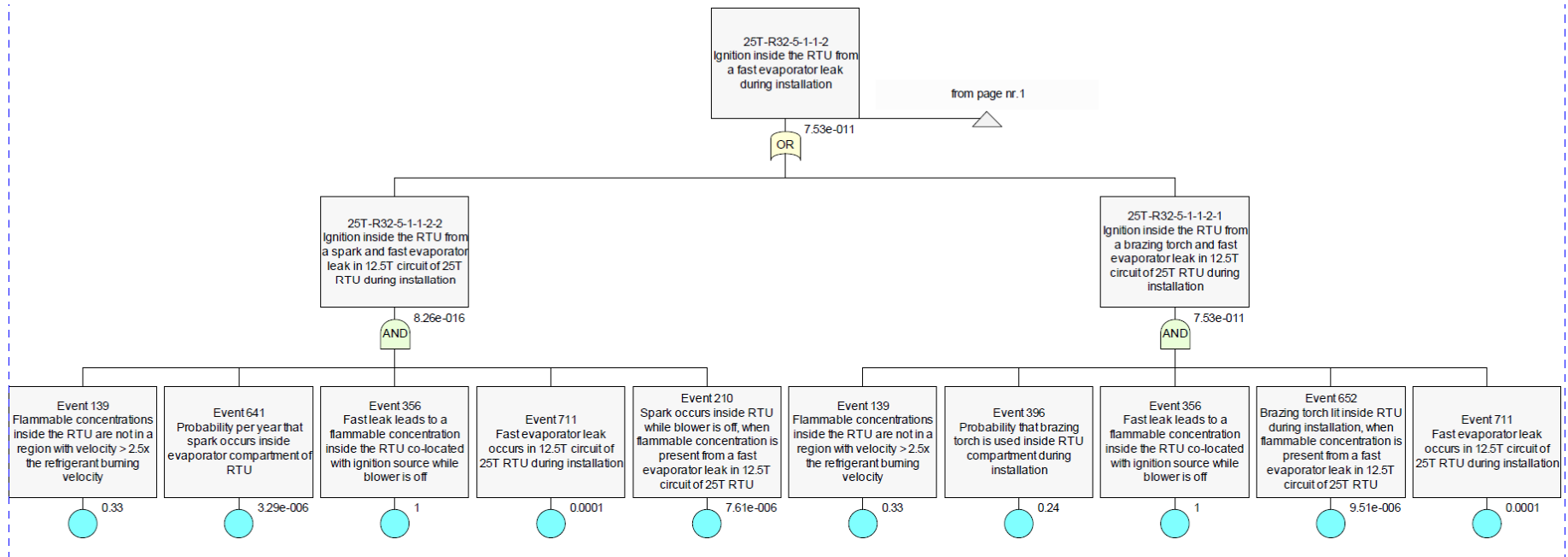

25T RTU Serving an Office – Installation – Page 1.3

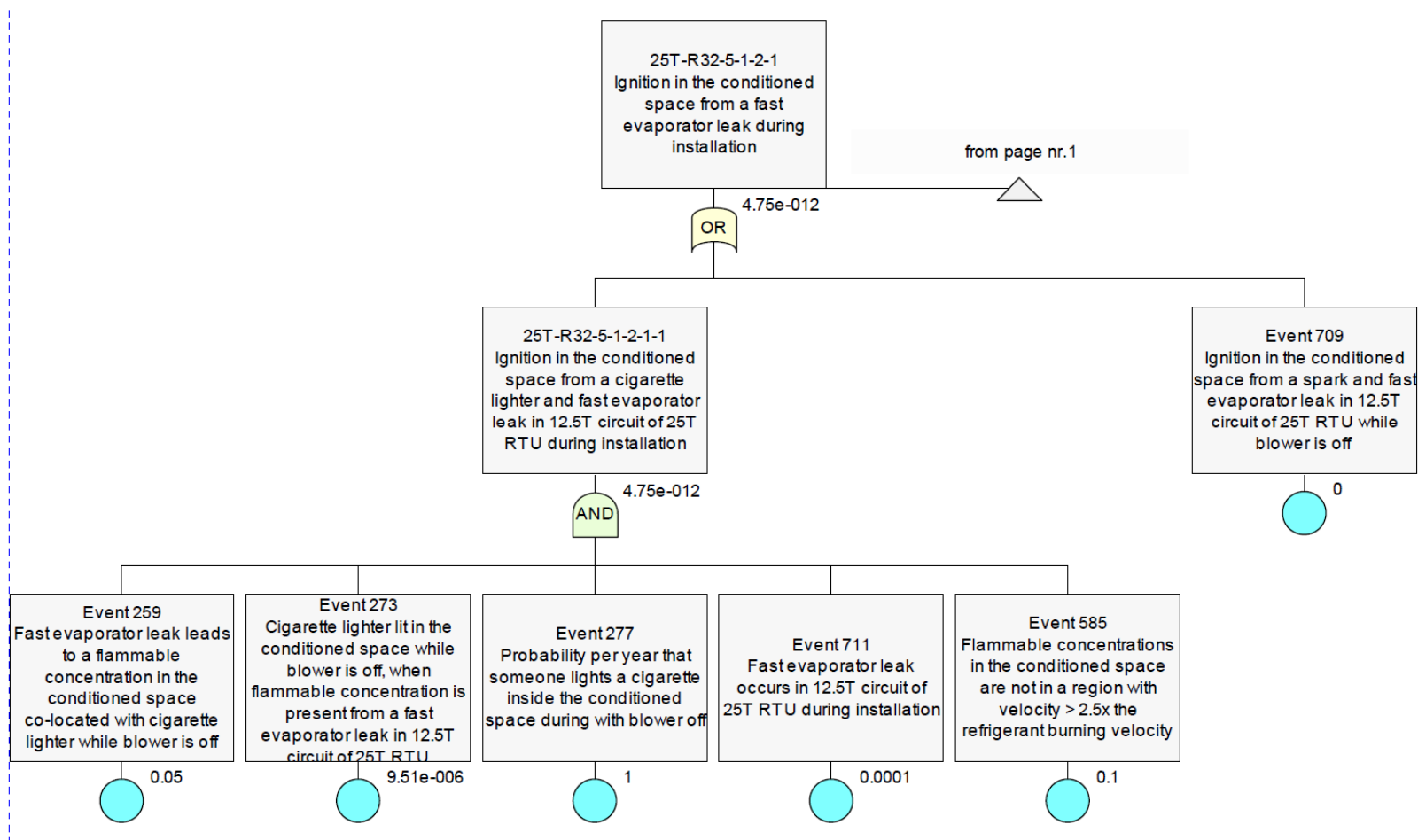

25T RTU Serving an Office – Installation – Page 1.4

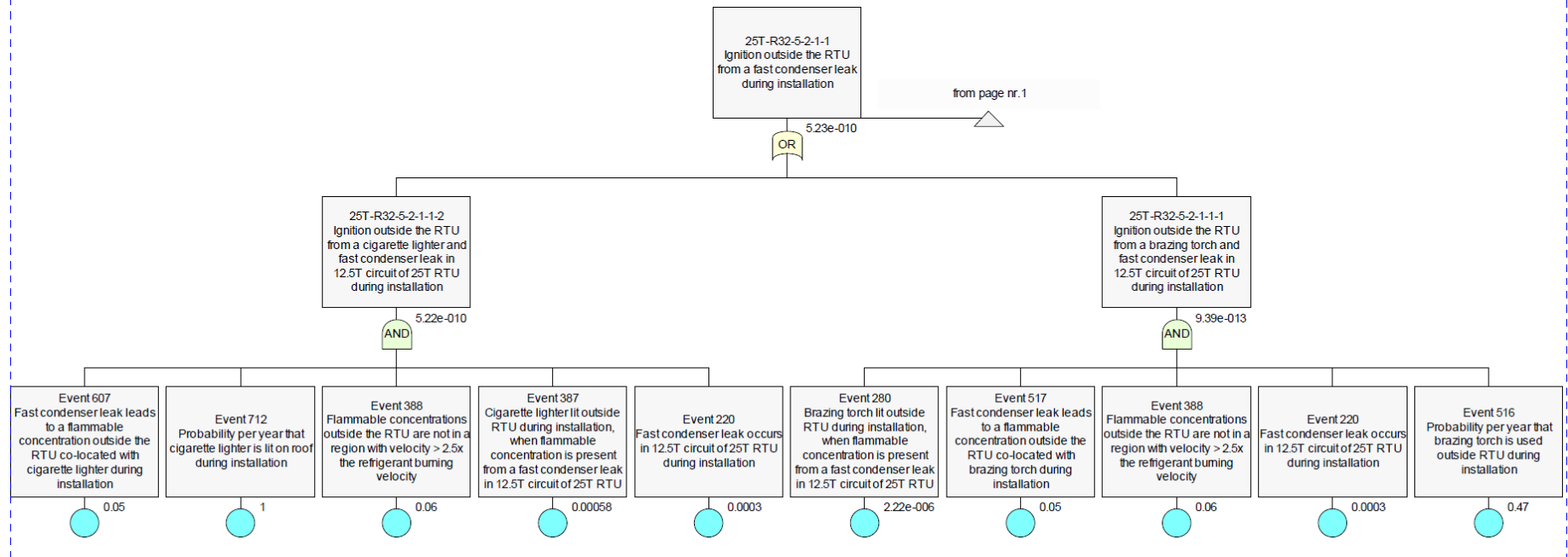

25T RTU Serving an Office – Installation – Page 1.5

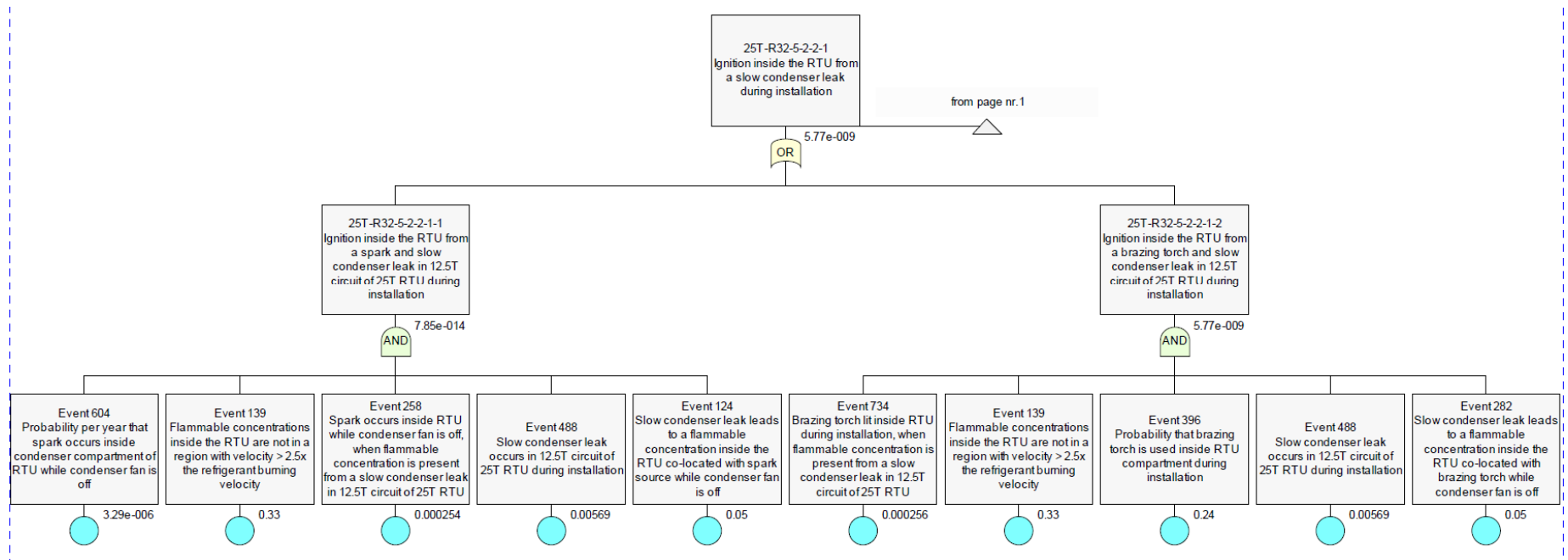

25T RTU Serving an Office – Installation – Page 1.6

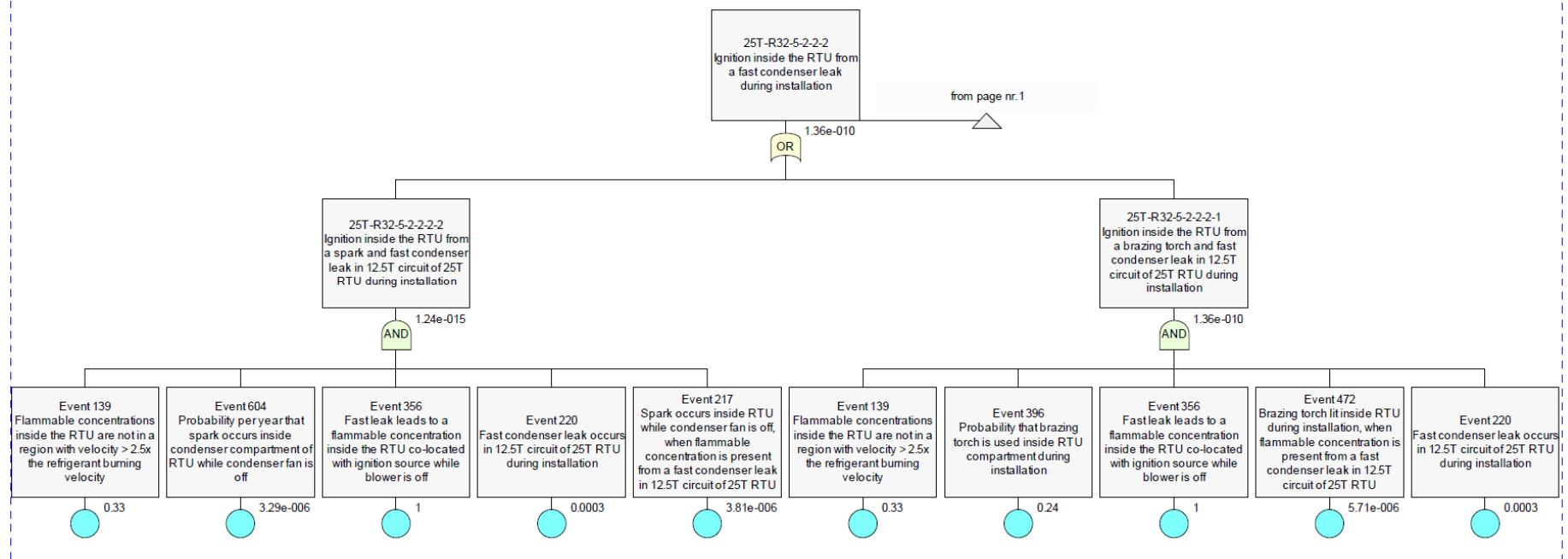

A.3 Fault Trees for Scenario E – 5T Ground-Mounted RTU Serving an Office

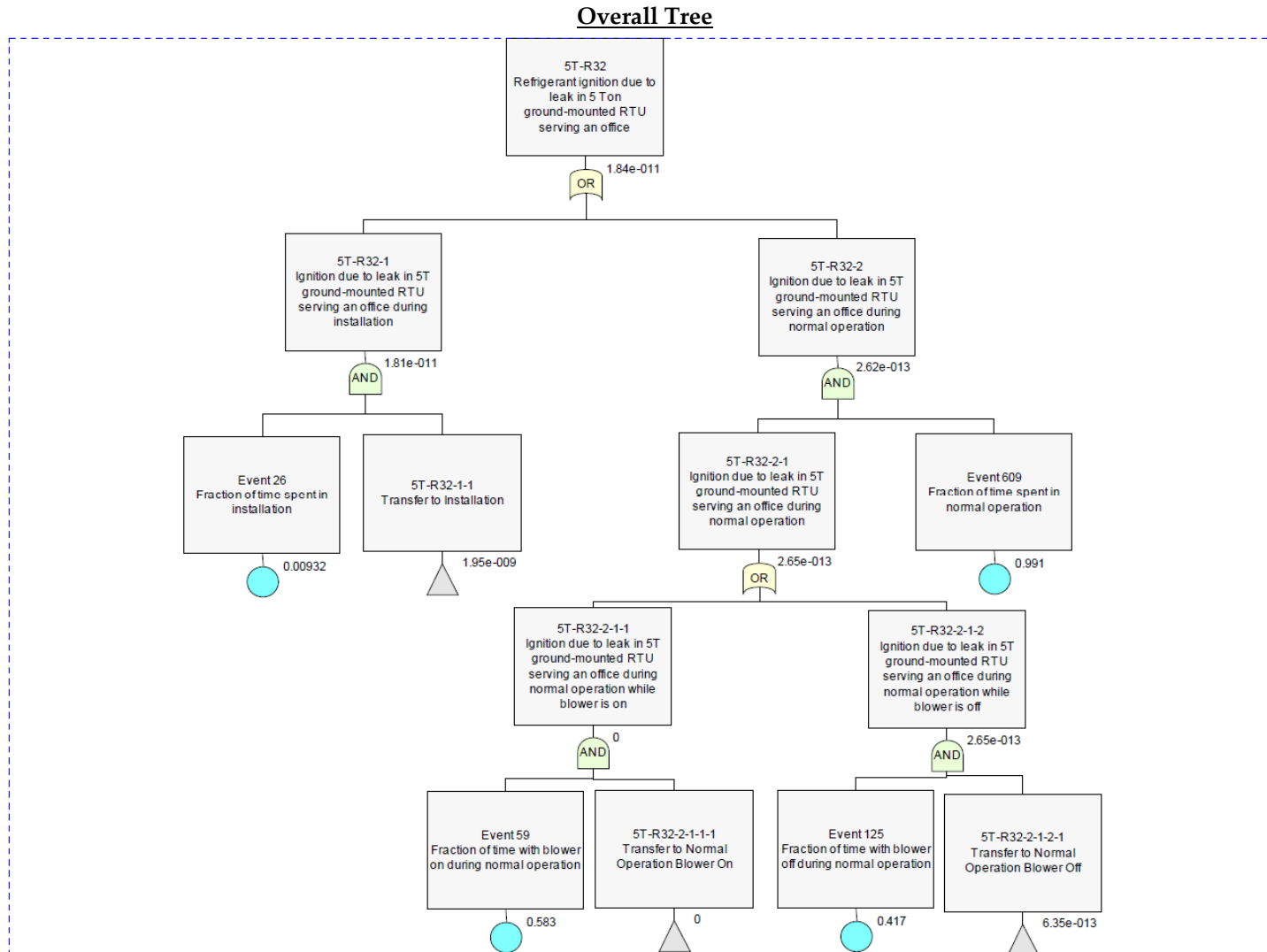

5T Ground-Mounted RTU Serving an Office – Normal Operation with Blower Off – Page 1

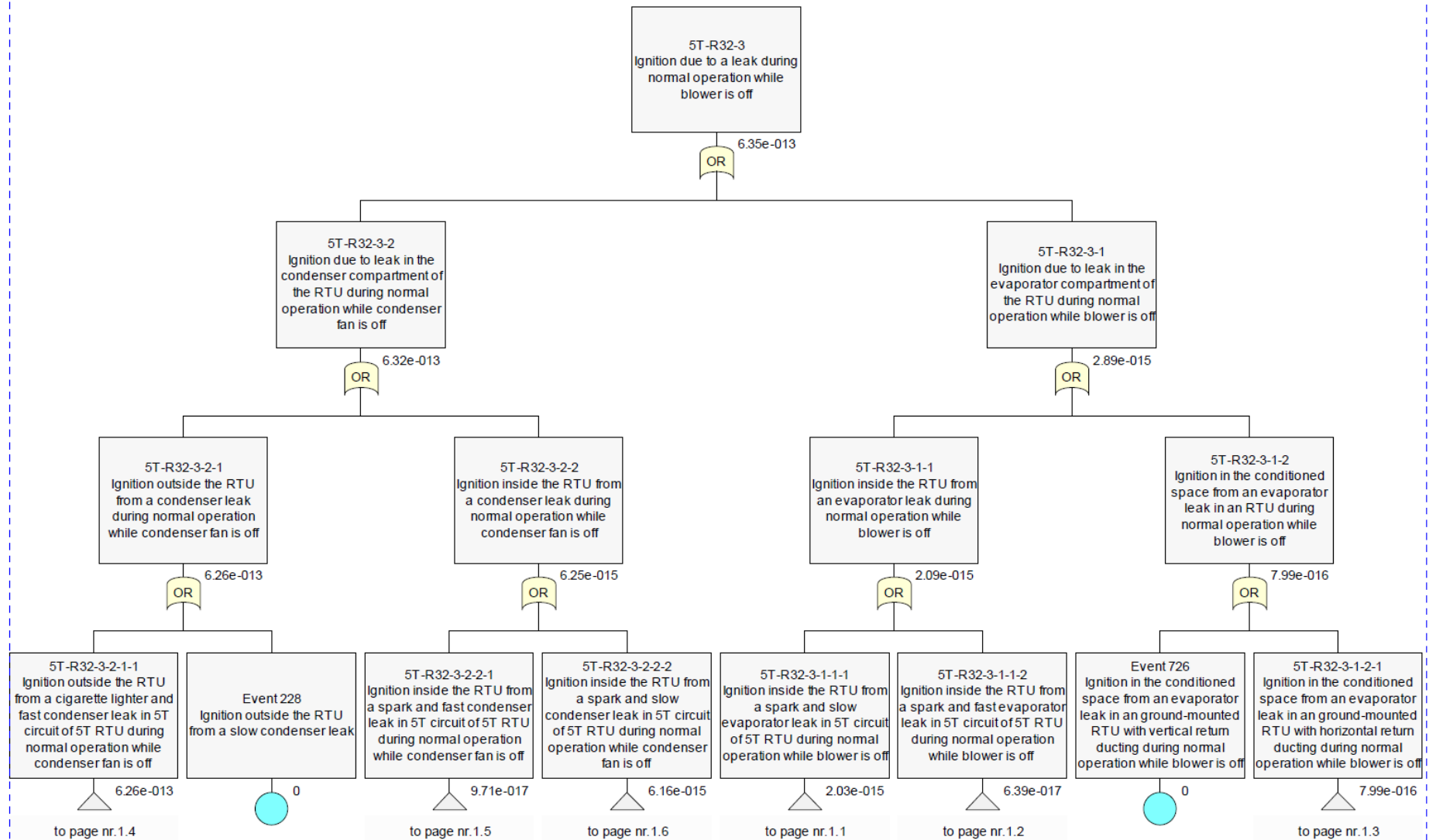

5T Ground-Mounted RTU Serving an Office – Normal Operation with Blower Off – Page 1.1

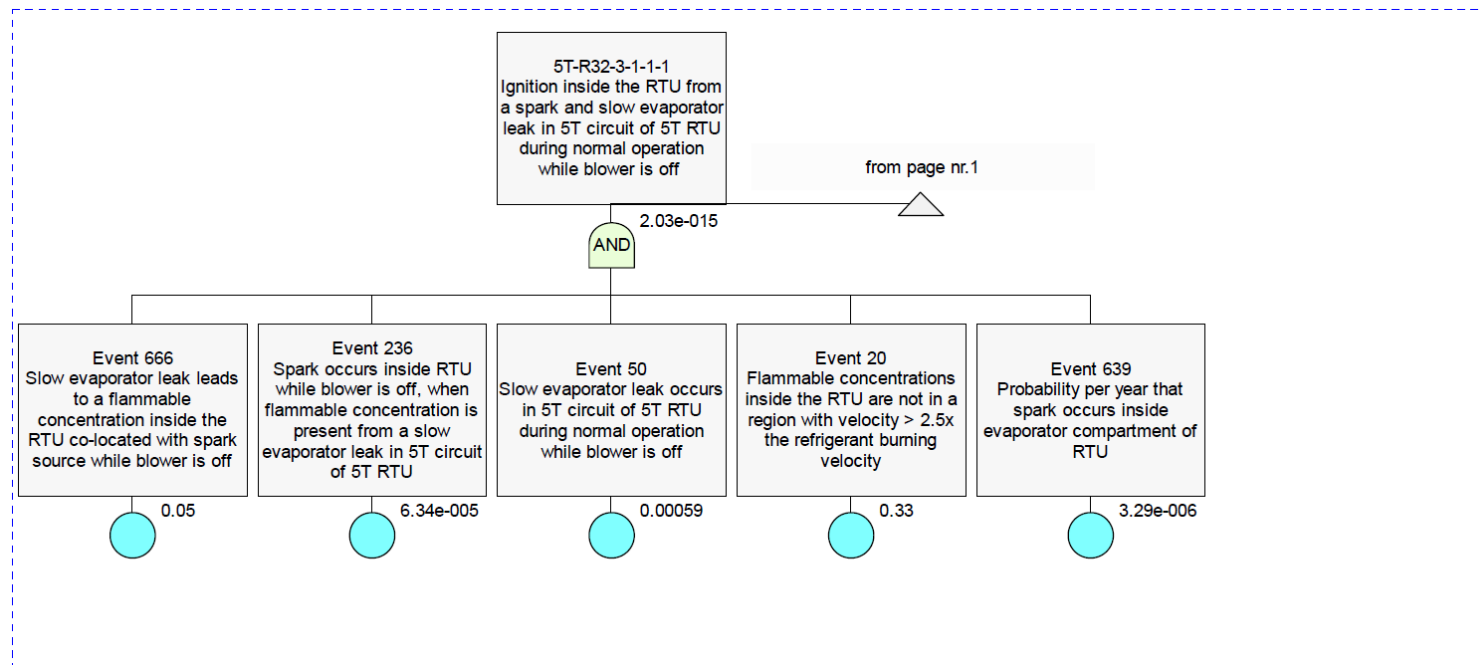

5T Ground-Mounted RTU Serving an Office – Normal Operation with Blower Off – Page 1.2

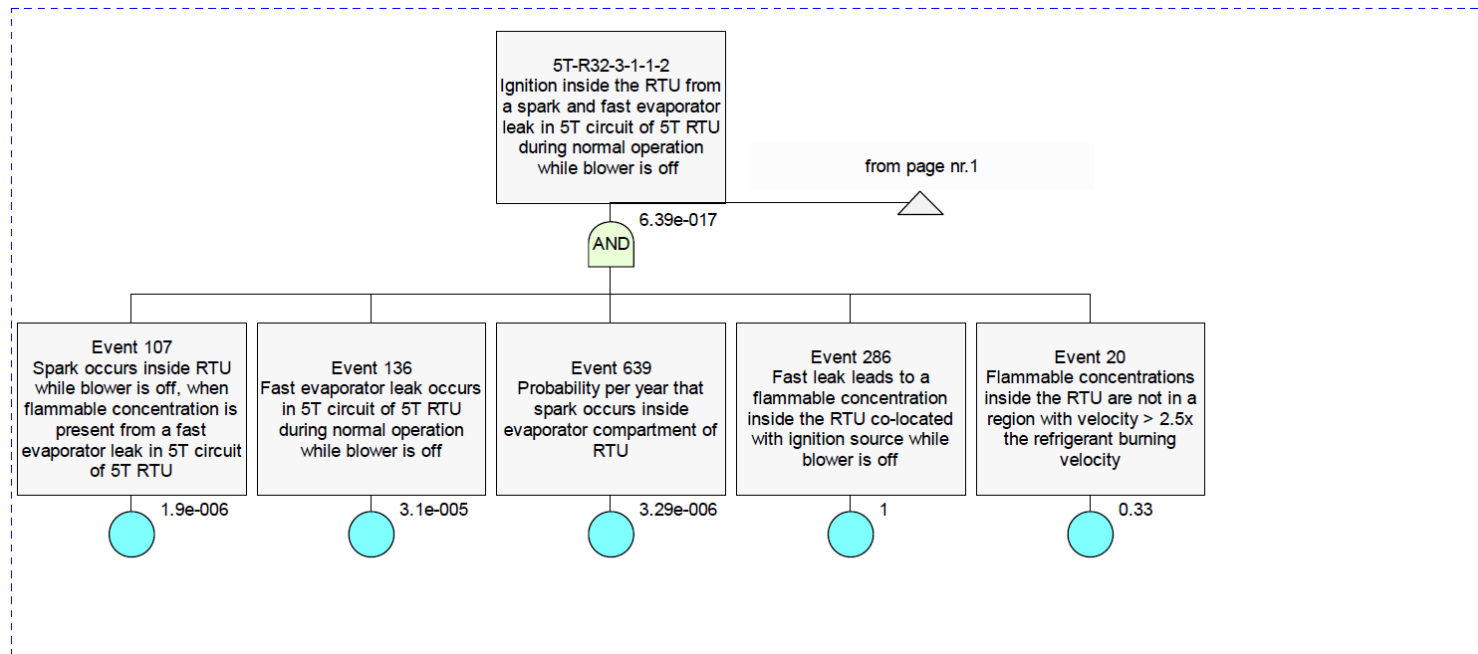

5T Ground-Mounted RTU Serving an Office – Normal Operation with Blower Off – Page 1.3

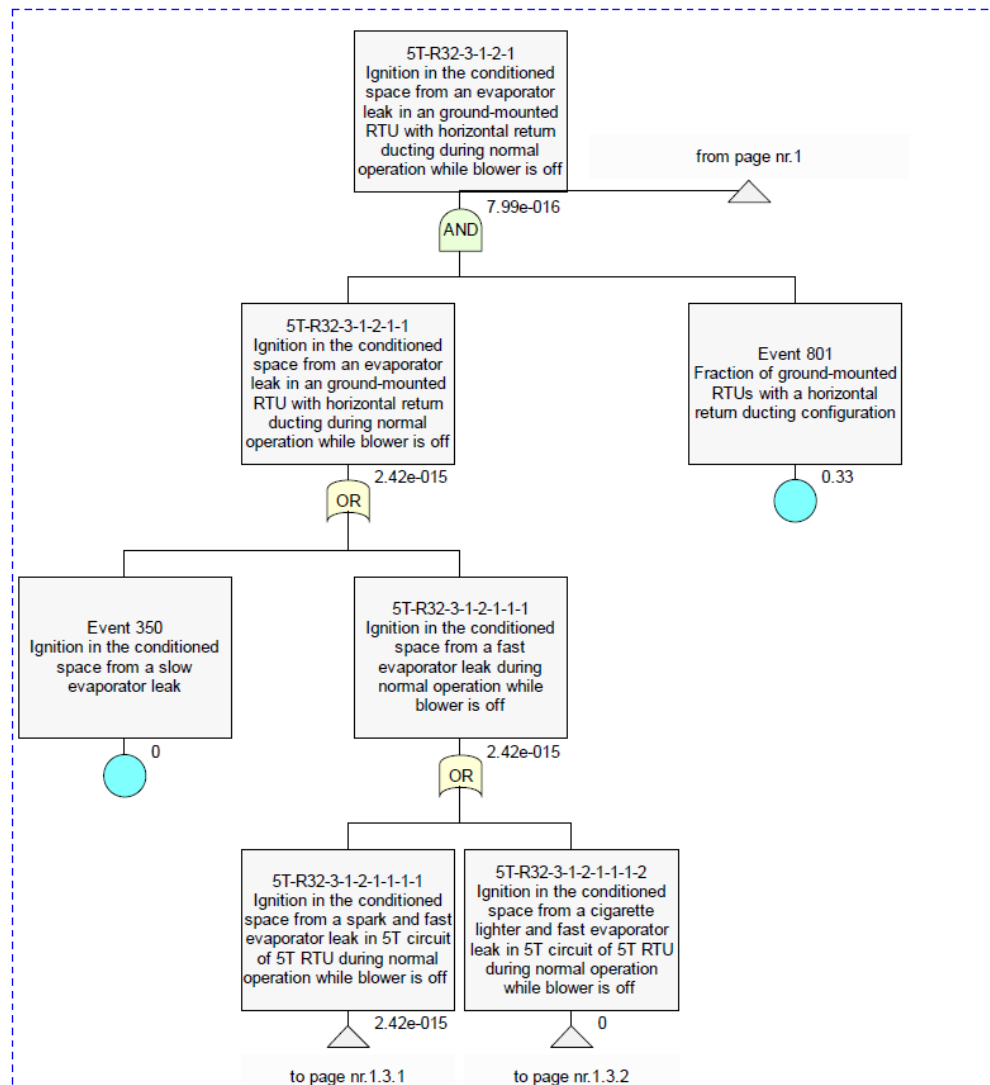

5T Ground-Mounted RTU Serving an Office – Normal Operation with Blower Off – Page 1.3.1

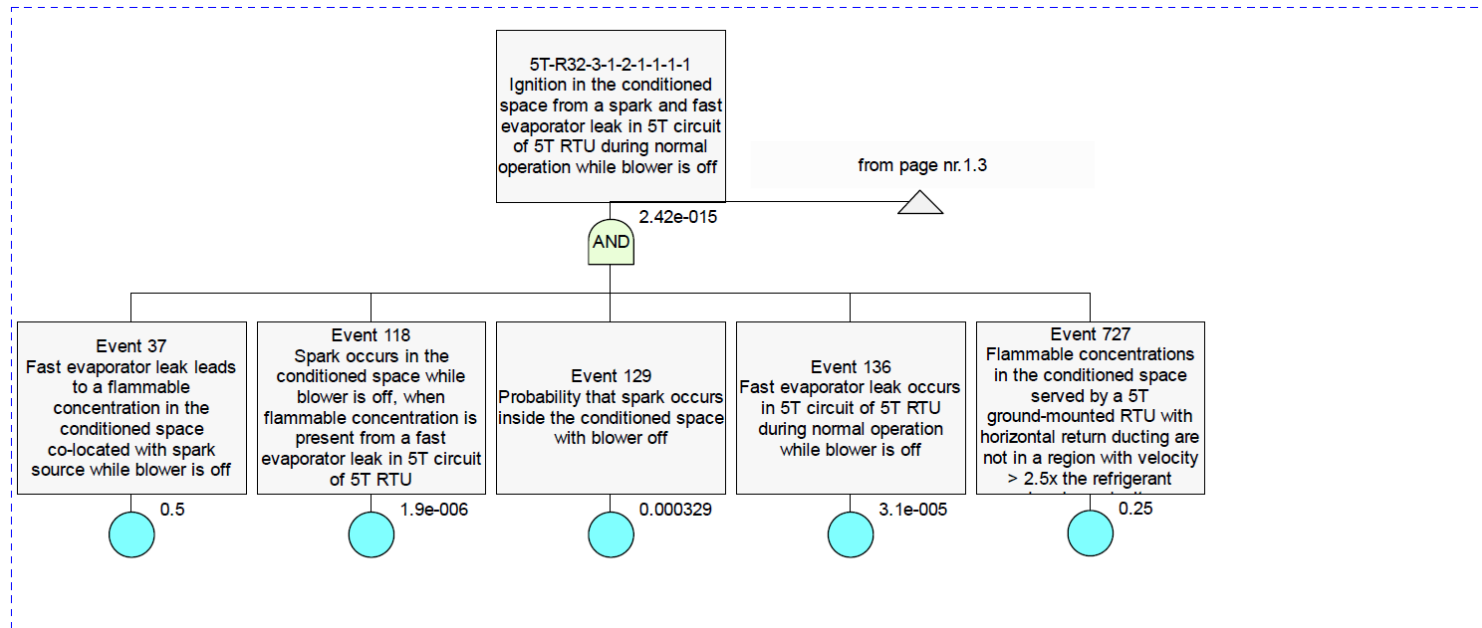

5T Ground-Mounted RTU Serving an Office – Normal Operation with Blower Off – Page 1.3.2

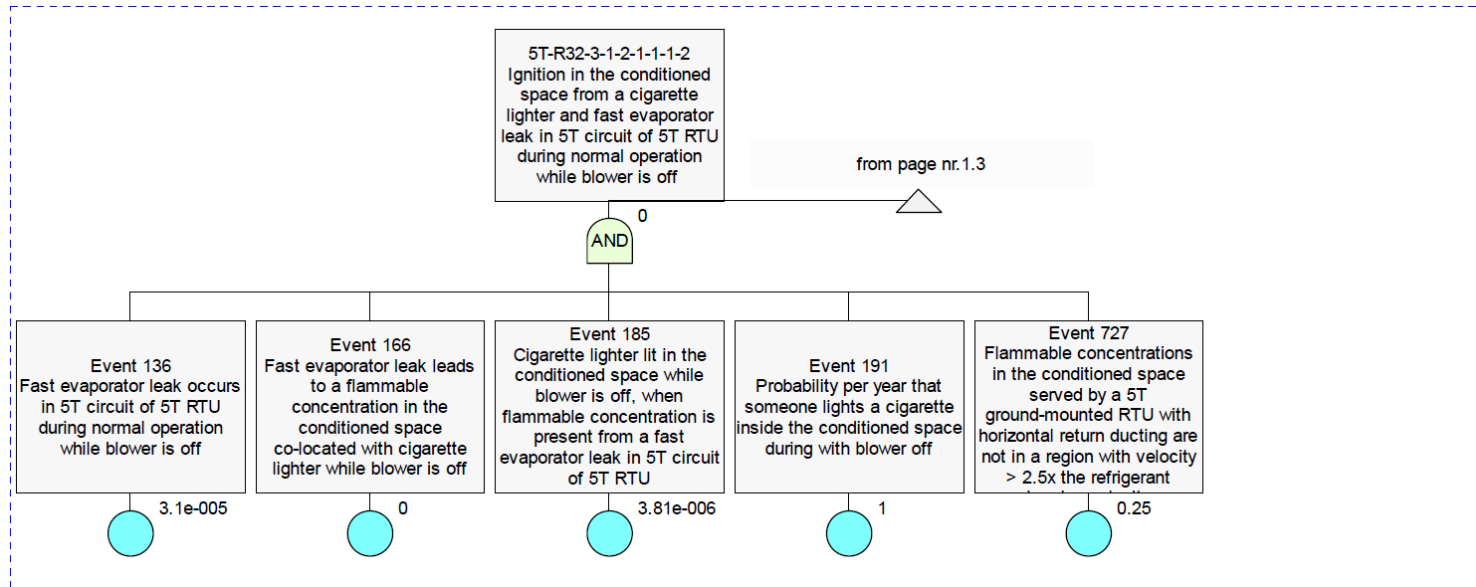

5T Ground-Mounted RTU Serving an Office – Normal Operation with Blower Off – Page 1.4

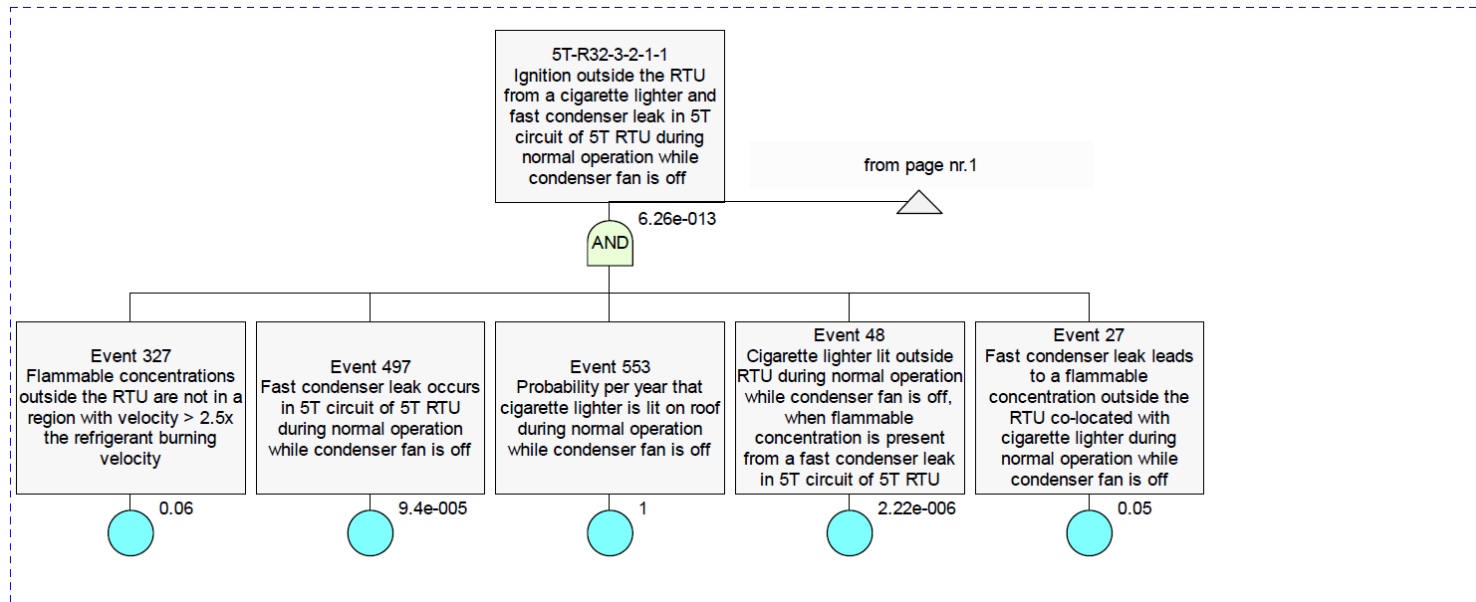

5T Ground-Mounted RTU Serving an Office – Normal Operation with Blower Off – Page 1.5

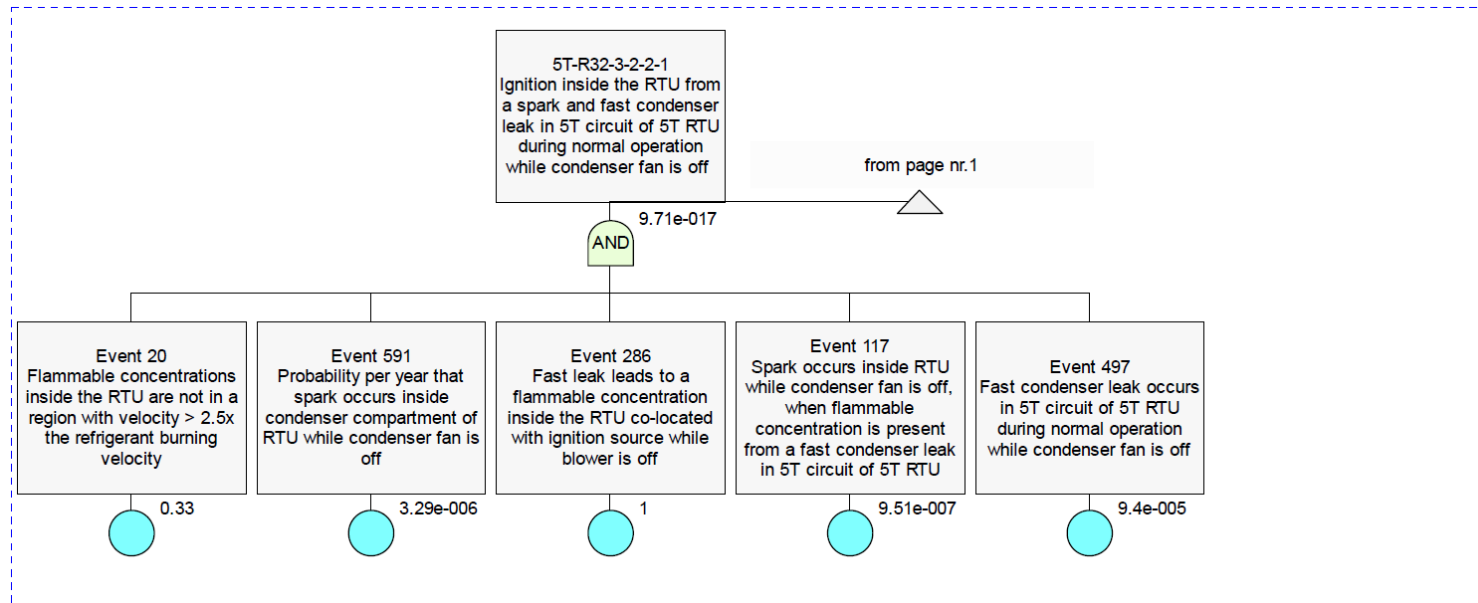

5T Ground-Mounted RTU Serving an Office – Normal Operation with Blower Off – Page 1.6

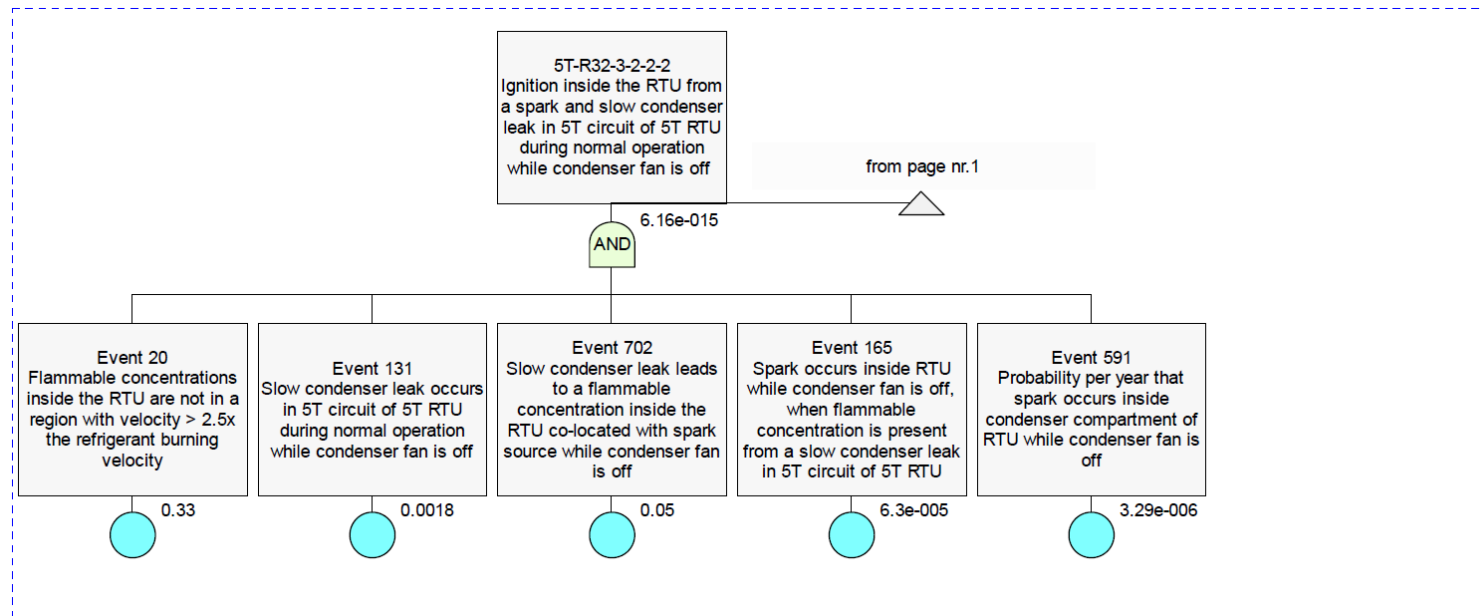

5T Ground-Mounted RTU Serving an Office – Normal Operation with Blower On

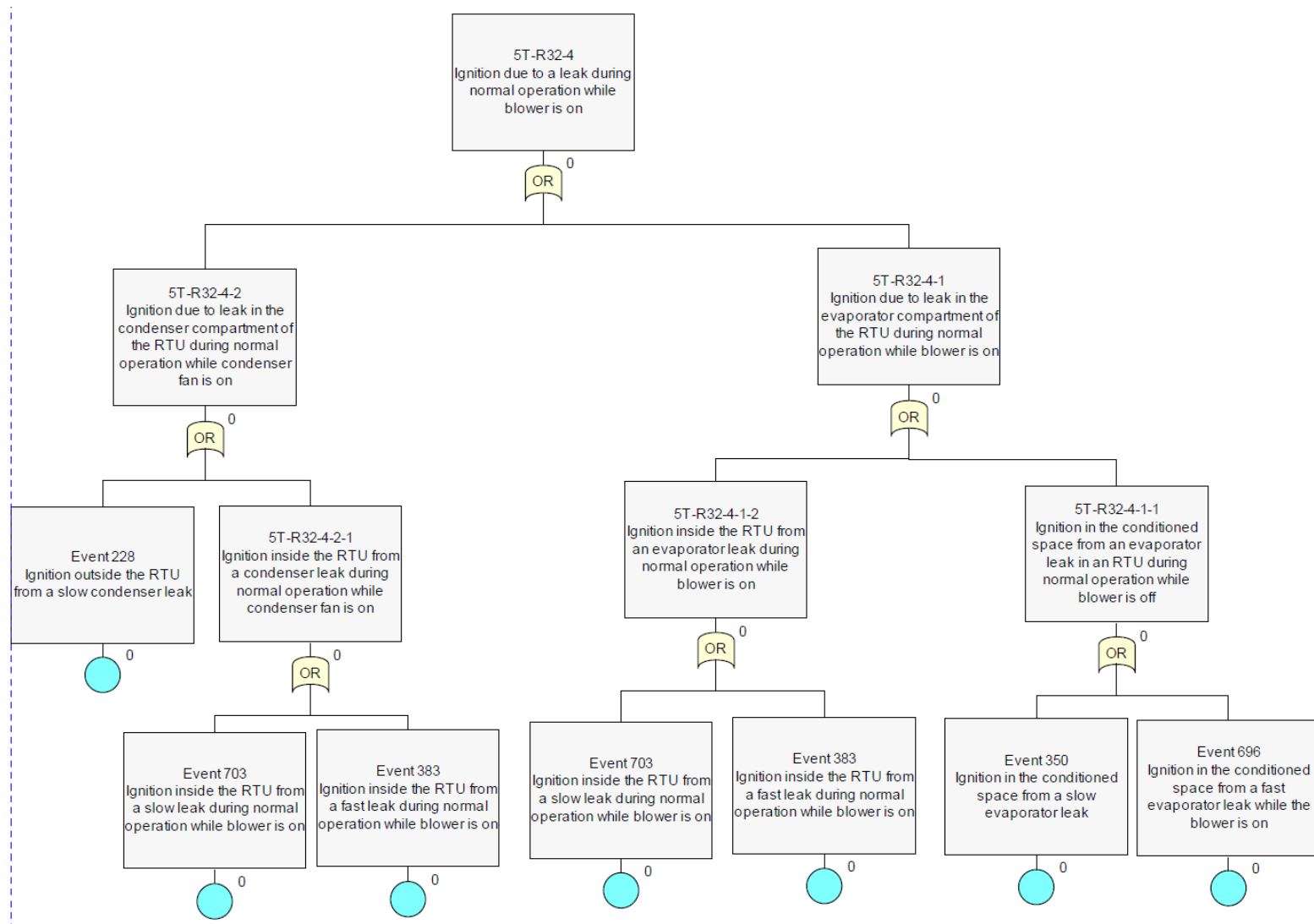

5T Ground-Mounted RTU Serving an Office – Installation – Page 1.1

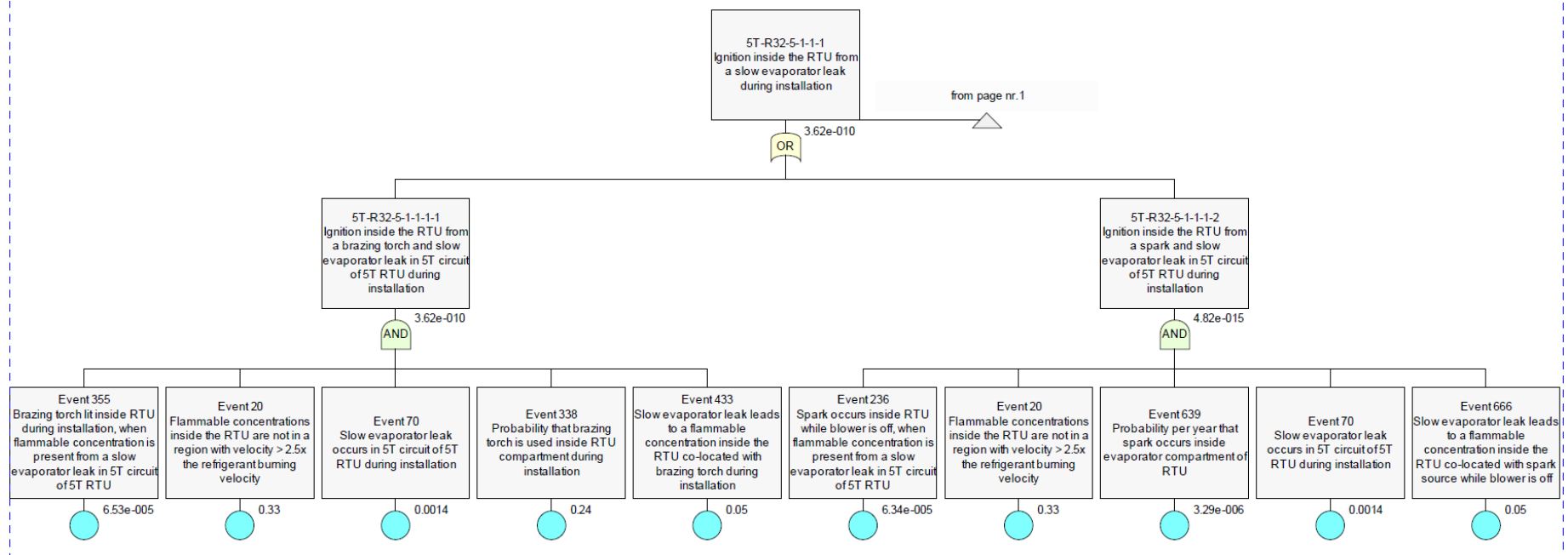

5T Ground-Mounted RTU Serving an Office – Installation – Page 1.2

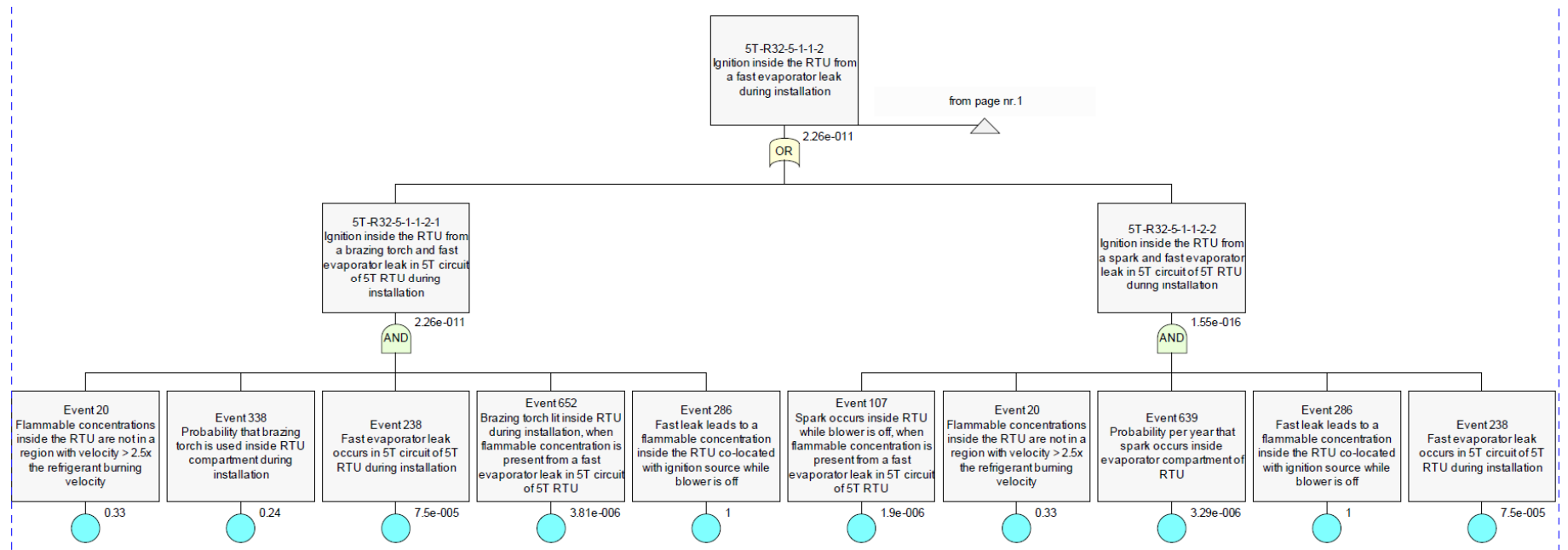

5T Ground-Mounted RTU Serving an Office – Installation – Page 1.3

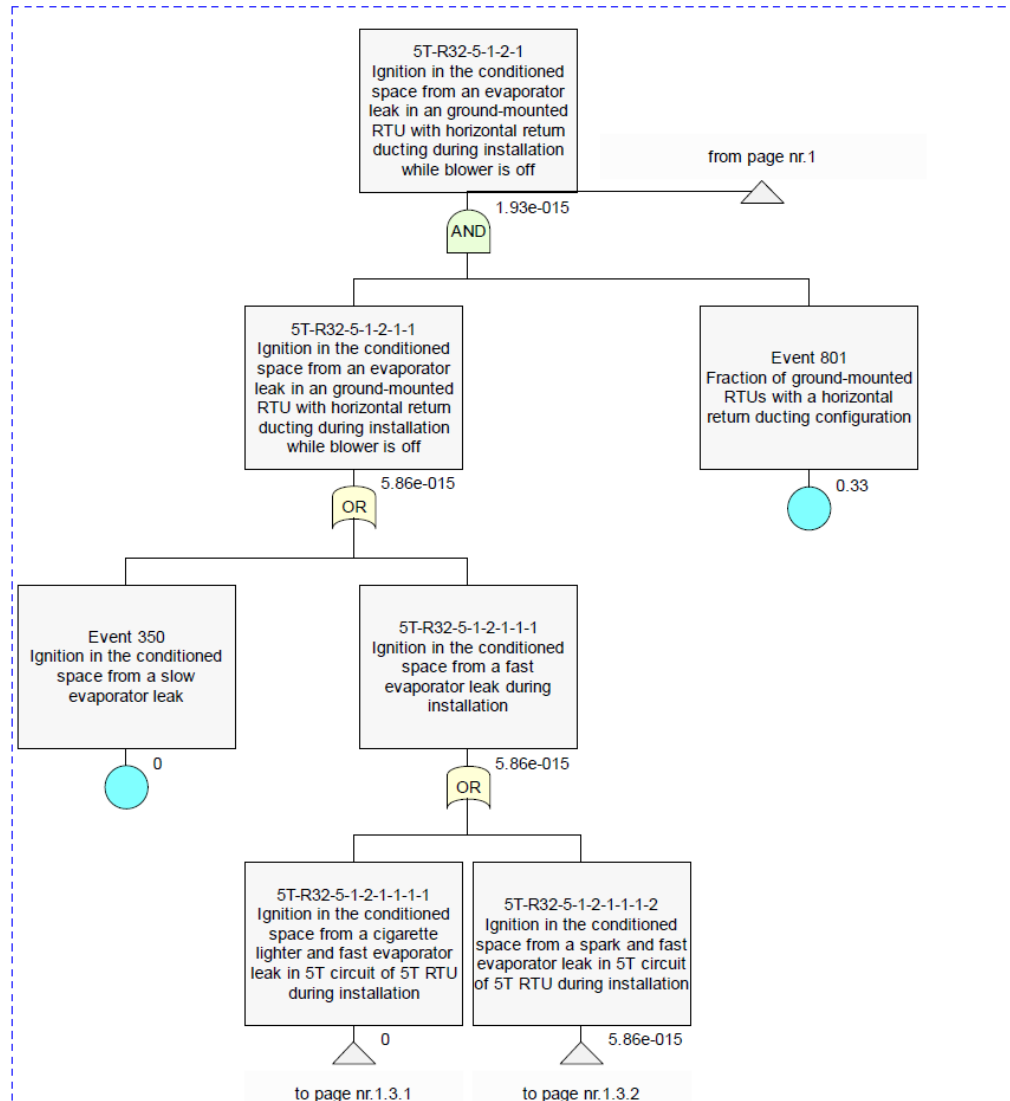

5T Ground-Mounted RTU Serving an Office – Installation – Page 1.3.1

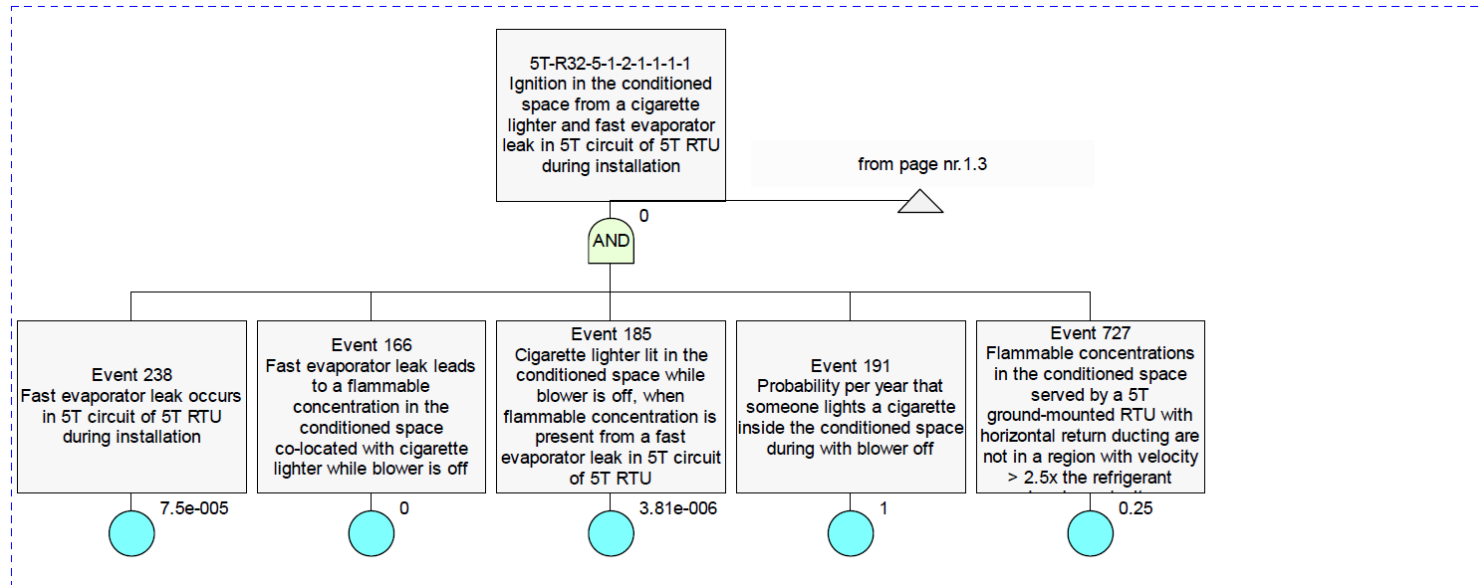

5T Ground-Mounted RTU Serving an Office – Installation – Page 1.3.2

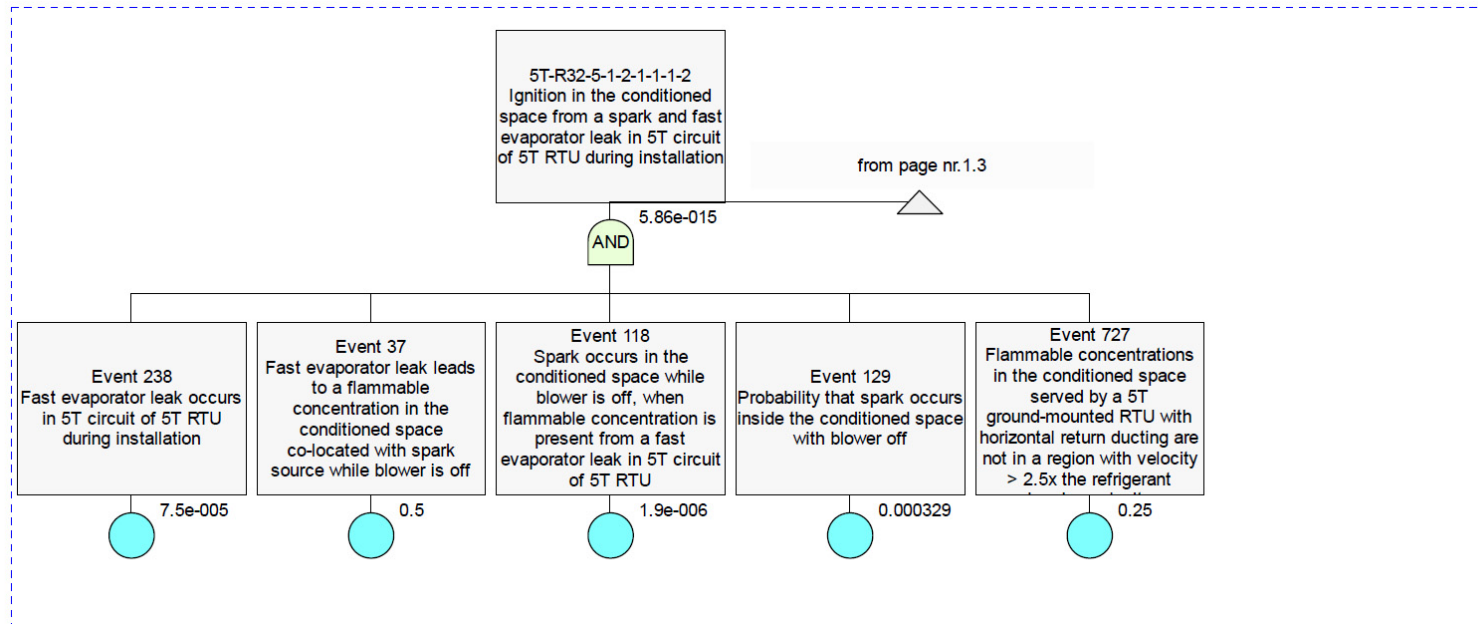

5T Ground-Mounted RTU Serving an Office – Installation – Page 1.4

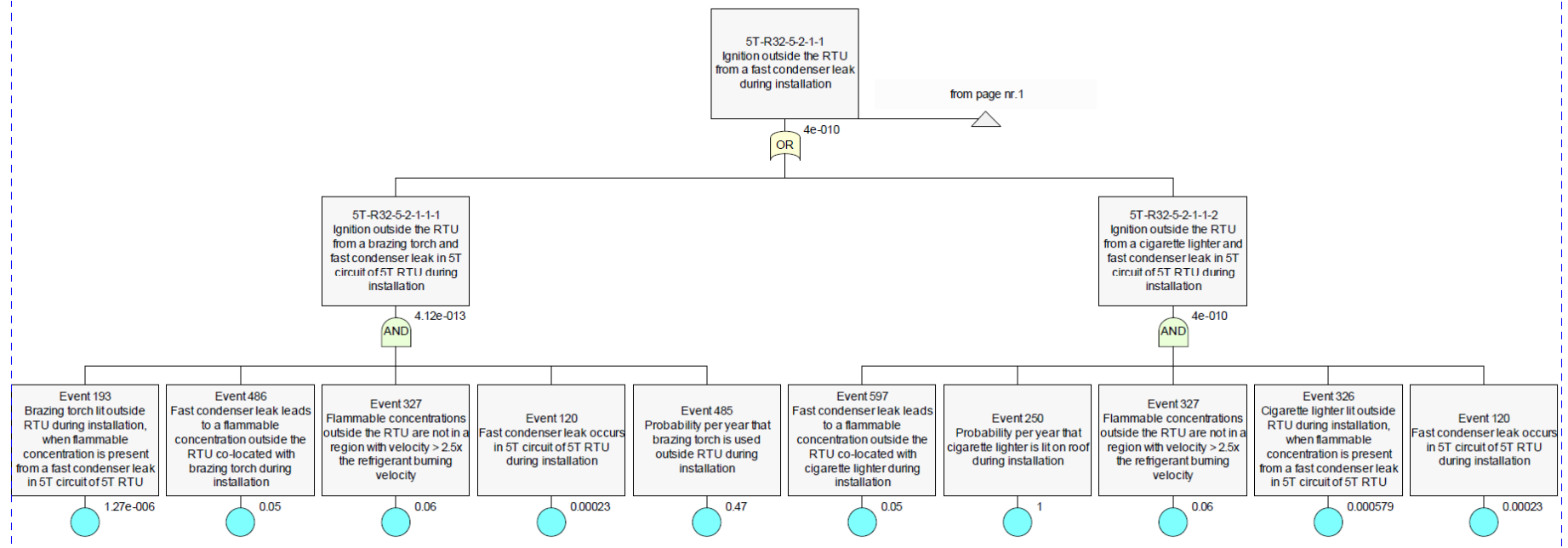

5T Ground-Mounted RTU Serving an Office – Installation – Page 1.5

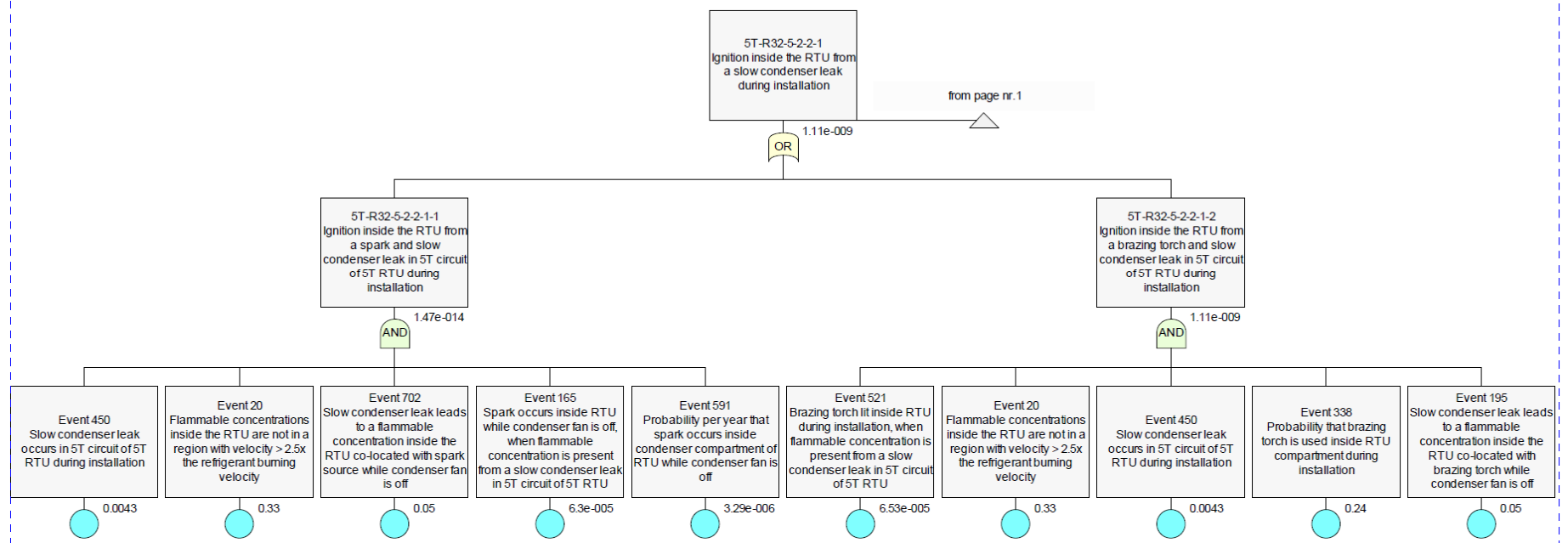

5T Ground-Mounted RTU Serving an Office – Installation – Page 1.6

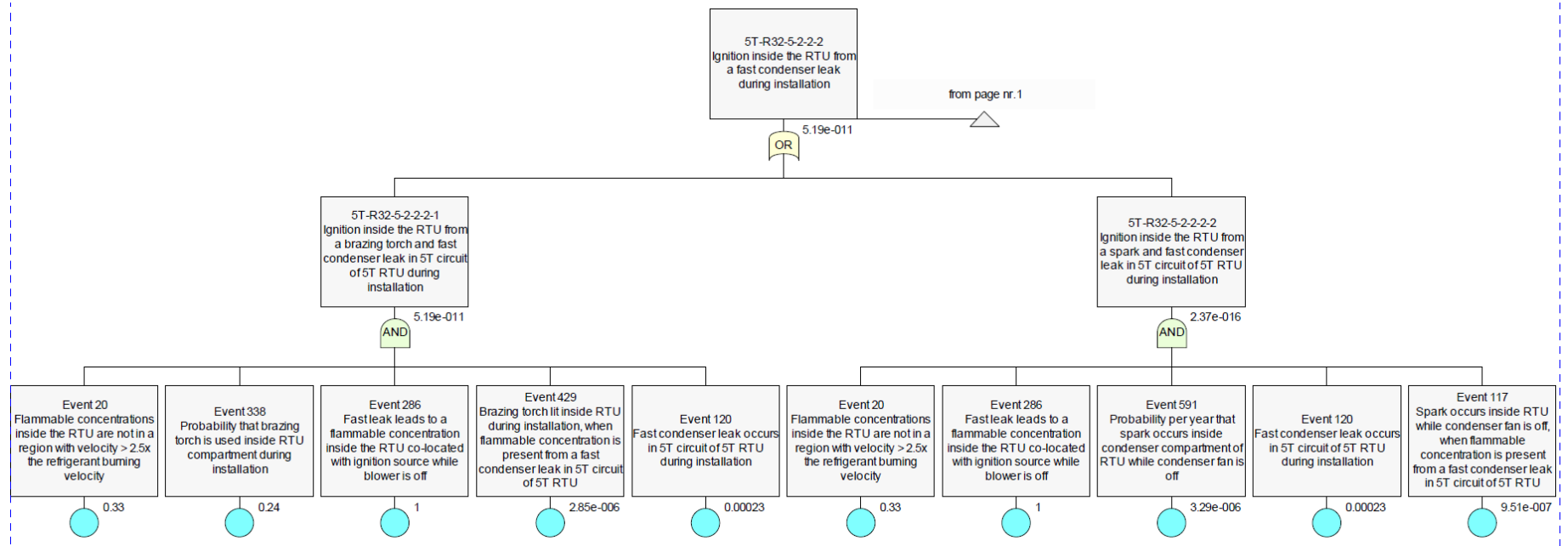

Appendix B. Fault Tree Rationales

B.1 Fault Tree Rationale for Scenarios A and B – 15T RTU Serving a Commercial Kitchen

R-32 Code	Mode of Operation	Blower Status	Probability Type	Compartment	Leak Speed	Circuit	Name	Description	R-32	R-1234yf
Event 106	Multiple	Off	Ignition Source	Evaporator	Fast	10T	Cigarette lighter lit in the conditioned space while blower is off, when flammable concentration is present from a fast evaporator leak in 10T circuit of 15T RTU	CFD results from Scenario 1 suggest that a fast R-32 leak would lead to a small flammable plume that would persist for ~2 min. Also assumed that cigarette lighter would be lit for 5 s per cigarette (from Gradient, 2015, "Risk Assessment...") and that someone might smoke a cigarette in the kitchen once per week when the blower is not operating.	1.2E-05	1.3E-05
Event 110	Installation	Off	Ignition Source	N/A	N/A	N/A	Probability per year that someone lights a cigarette inside the conditioned space during with blower off	Based on assumption that someone would smoke a cigarette inside the conditioned space once per week with the blower off.	1	1
Event 116	Installation	Off	Ignition Source	Condenser	Fast	10T	Brazing torch lit outside RTU during installation, when flammable concentration is present from a fast condenser leak in 10T circuit of 15T RTU	Assumed that a brazing torch would be lit outside the RTU for 15 sec before and after brazing inside the RTU. CFD results from Scenario 6 suggest that flammable concentrations may persist outside the RTU for ~20 sec after a fast leak begins.	1.6E-06	1.7E-06
Event 118	Multiple	Off	Flammable Concentration	Condenser	Slow	N/A	Slow condenser leak leads to a flammable concentration inside the RTU co-located with brazing torch while condenser fan is off	CFD results from Scenario 4 suggest that a slow condenser leak will cause a small pool inside the RTU with flammable concentration. Assumed that there is a 5% chance that this small pool will be co-located with the brazing torch.	0.05	0.05
Event 132	Installation	Off	Ignition Source	Condenser	Slow	5T	Brazing torch lit inside RTU during installation, when flammable concentration is present from a slow condenser leak in 5T circuit of 15T RTU	This value is scaled down from that used for a leak in the 10 ton circuit, assuming that flammable concentrations for a leak from the 5 ton circuit would exist for half the time for a leak from the 10 ton circuit.	6.5E-05	8.1E-05
Event 133	Multiple	Off	Ignition Source	Evaporator	Fast	5T	Cigarette lighter lit in the conditioned space while blower is off, when flammable concentration is present from a fast evaporator leak in 5T circuit of 15T RTU	This value is scaled down from that used for a leak in the 10 ton circuit, assuming that flammable concentrations for a leak from the 5 ton circuit would exist for half the time for a leak from the 10 ton circuit.	1.0E-05	1.1E-05

R-32 Code	Mode of Operation	Blower Status	Probability Type	Compartment	Leak Speed	Circuit	Name	Description	R-32	R-1234yf
Event 14	Installation	Off	Ignition Source	N/A	N/A	N/A	Probability per year that kitchen has gas pilot that is lit in the conditioned space	Based on assumptions that 90% of commercial kitchens have gas cooking equipment (either natural gas or propane), and that 80% of commercial kitchens with gas have cooking equipment with pilots.	0.72	0.72
Event 146	Installation	Off	Ignition Source	Condenser	Fast	5T	Cigarette lighter lit outside RTU during installation, when flammable concentration is present from a fast condenser leak in 5T circuit of 15T RTU	This value is scaled down from that used for a leak in the 10 ton circuit, assuming that flammable concentrations for a leak from the 5 ton circuit would exist for half the time for a leak from the 10 ton circuit.	0.00058	0.00058
Event 149	Multiple	Both	No ignition	Condenser	Slow	N/A	Ignition outside the RTU from a slow condenser leak	CFD results from Scenario 4 suggest that a slow condenser leak would not lead to flammable concentrations outside the RTU.	0	0
Event 159	Multiple	Off	Ignition Source	Evaporator	Slow	10T	Spark occurs inside RTU while blower is off, when flammable concentration is present from a slow evaporator leak in 10T circuit of 15T RTU	CFD results from Scenario 4 suggest that a slow leak of R-32 would lead to a small pool of flammable concentration that would persist for ~4000 sec.	0.00013	0.00016
Event 175	Multiple	Off	Flammable Concentration	Evaporator	Fast	N/A	Fast evaporator leak leads to a flammable concentration in the conditioned space co-located with gas pilot flame while blower is off	Assumption based on size of plume of flammable concentration seen in CFD Scenario 1 as well as consideration of typical layouts of commercial kitchens.	0.025	0.025
Event 193	Multiple	Off	Ignition Source	Evaporator	Fast	5T	Spark occurs inside RTU while blower is off, when flammable concentration is present from a fast evaporator leak in 5T circuit of 15T RTU	This value is scaled down from that used for a leak in the 10 ton circuit, assuming that flammable concentrations for a leak from the 5 ton circuit would exist for half the time for a leak from the 10 ton circuit.	1.9E-06	2.4E-06
Event 208	Multiple	Off	Flammable Concentration	N/A	Fast	N/A	Fast leak leads to a flammable concentration inside the RTU co-located with ignition source while blower is off	CFD results from Scenario 1 suggest that the entire volume inside the RTU would be filled with a region of flammable concentrations.	1	1
Event 212	Multiple	Off	Flammable Concentration	Condenser	Slow	N/A	Slow condenser leak leads to a flammable concentration inside the RTU co-located with spark source while condenser fan is off	CFD results from Scenario 4 suggest that a slow condenser leak will cause a small pool inside the RTU with flammable concentration. Assumption that there is a 5% chance that this small pool will be co-located with a spark source.	0.05	0.05

R-32 Code	Mode of Operation	Blower Status	Probability Type	Compartment	Leak Speed	Circuit	Name	Description	R-32	R-1234yf
Event 247	Installation	Off	Ignition Source	Condenser	Fast	10T	Cigarette lighter lit outside RTU during installation, when flammable concentration is present from a fast condenser leak in 10T circuit of 15T RTU	Calculated based on assumption that ten cigarettes might be smoked per day on the roof of the commercial kitchen during installation. This also assumes that a lighter would be lit for 5 sec to light one cigarette (from Gradient, 2015, "Risk Assessment..."). CFD results from Scenario 6 suggest that flammable concentrations may persist outside the RTU for ~40 sec after a fast leak begins.	0.00058	0.00058
Event 248	Multiple	Off	Velocity	N/A	N/A	N/A	Flammable concentrations outside the RTU are not in a region with velocity > 2.5x the refrigerant burning velocity	Assumed that velocity outside the RTU would only be < 2.5x the burning velocity in still air (no wind) conditions, which are estimated to occur 6% of the time (from Gradient, 2015, "Risk Assessment...").	0.06	0.06
Event 258	Installation	Off	Ignition Source	N/A	N/A	N/A	Probability that brazing torch is used inside RTU compartment during installation	Based on a weighted average of likelihood a brazing torch is used in installation (5%) and in servicing requiring the RTU to be off (50%). Assumed that 50% of brazing done in each RTU compartment.	0.24	0.24
Event 264	Installation	Off	Ignition Source	Evaporator	Fast	5T	Brazing torch lit inside RTU during installation, when flammable concentration is present from a fast evaporator leak in 5T circuit of 15T RTU	This value is scaled down from that used for a leak in the 10 ton circuit, assuming that flammable concentrations for a leak from the 5 ton circuit would exist for half the time for a leak from the 10 ton circuit.	3.8E-06	4.3E-06
Event 27	Normal	Off	Ignition Source	Condenser	Fast	5T	Cigarette lighter lit outside RTU during normal operation while condenser fan is off, when flammable concentration is present from a fast condenser leak in 5T circuit of 15T RTU	This value is scaled down from that used for a leak in the 10 ton circuit, assuming that flammable concentrations for a leak from the 5 ton circuit would exist for half the time for a leak from the 10 ton circuit.	4.8E-07	5.6E-07
Event 271	Multiple	Both	No ignition	Evaporator	Slow	N/A	Ignition in the conditioned space from a slow evaporator leak	CFD results from Scenario 4 suggest that flammable concentrations would not develop in the conditioned space as a result of a slow leak.	0	0
Event 277	Installation	Off	Ignition Source	Evaporator	Slow	10T	Brazing torch lit inside RTU during installation, when flammable concentration is present from a slow evaporator leak in 10T circuit of 15T RTU	Calculated based on assumption that brazing torch is used inside the RTU for 60 sec. CFD results from Scenario 4 suggest that a slow leak of R-32 would lead to a small pool of flammable concentration that would persist for ~4000 sec.	0.00013	0.00016

R-32 Code	Mode of Operation	Blower Status	Probability Type	Compartment	Leak Speed	Circuit	Name	Description	R-32	R-1234yf
Event 282	Installation	Off	Leak	Condenser	Slow	Both	Slow condenser leak occurs in one circuit of 15T RTU during installation	Estimate provided by the AHRI PMS.	0.0029	0.0029
Event 287	Multiple	Off	Ignition Source	Evaporator	Slow	5T	Spark occurs inside RTU while blower is off, when flammable concentration is present from a slow evaporator leak in 5T circuit of 15T RTU	This value is scaled down from that used for a leak in the 10 ton circuit, assuming that flammable concentrations for a leak from the 5 ton circuit would exist for half the time for a leak from the 10 ton circuit.	6.3E-05	7.9E-05
Event 30	Multiple	Off	Ignition Source	Evaporator	Fast	10T	Spark occurs inside RTU while blower is off, when flammable concentration is present from a fast evaporator leak in 10T circuit of 15T RTU	CFD results from Scenario 1 suggest that flammable concentrations would persist inside the RTU for ~2 min after a fast leak begins.	3.8E-06	4.8E-06
Event 306	Normal	On	No ignition	N/A	Fast	N/A	Ignition inside the RTU from a fast leak during normal operation while blower is on	CFD results from Scenario 3 suggest that flammable concentrations would only develop inside the RTU in the immediate vicinity of the leak, and that the velocity with the blower on would be significantly higher than 2.5x the burning velocity.	0	0
Event 324	Installation	Off	Leak	Evaporator	Slow	Both	Slow evaporator leak occurs in one circuit of 15T RTU during installation	Estimate provided by the AHRI PMS.	0.00095	0.00095
Event 325	Installation	Off	Ignition Source	Condenser	Fast	5T	Brazing torch lit outside RTU during installation, when flammable concentration is present from a fast condenser leak in 5T circuit of 15T RTU	This value is scaled down from that used for a leak in the 10 ton circuit, assuming that flammable concentrations for a leak from the 5 ton circuit would exist for half the time for a leak from the 10 ton circuit.	1.3E-06	1.4E-06
Event 352	Installation	Off	Ignition Source	Condenser	Fast	10T	Brazing torch lit inside RTU during installation, when flammable concentration is present from a fast condenser leak in 10T circuit of 15T RTU	Assumed that a brazing torch would be lit inside the RTU for 60 sec. CFD results from Scenario 1 suggest that flammable concentrations would persist inside the RTU for ~1 min after a fast leak begins.	3.8E-06	4.3E-06
Event 356	Installation	Off	Flammable Concentration	Evaporator	Slow	N/A	Slow evaporator leak leads to a flammable concentration inside the RTU co-located with brazing torch during installation	CFD results from Scenario 4 suggest that a slow condenser leak will cause a small pool inside the RTU with flammable concentration. Assumed that there is a 5% chance that this small pool will be co-located with the brazing torch.	0.05	0.05

R-32 Code	Mode of Operation	Blower Status	Probability Type	Compartment	Leak Speed	Circuit	Name	Description	R-32	R-1234yf
Event 38	Multiple	Off	Ignition Source	Condenser	Fast	10T	Spark occurs inside RTU while condenser fan is off, when flammable concentration is present from a fast condenser leak in 10T circuit of 15T RTU	CFD results from Scenario 1 suggest that flammable concentrations would persist inside the RTU for ~1 min after a fast leak begins. This is half the value used for a fast evaporator leak, because it is assumed that the refrigerant will disperse significantly faster in the condenser compartment because refrigerant can rapidly disperse to the air surrounding the RTU.	1.9E-06	2.4E-06
Event 39	Multiple	Off	Ignition Source	Evaporator	Fast	10T	Spark occurs in the conditioned space while blower is off, when flammable concentration is present from a fast evaporator leak in 10T circuit of 15T RTU	CFD results from Scenario 1 suggest that a fast leak of R-32 would lead to a small plume of flammable concentration that would persist for ~2 min.	3.8E-06	4.8E-06
Event 390	Multiple	Off	Velocity	N/A	N/A	N/A	Flammable concentrations inside the RTU are not in a region with velocity > 2.5x the refrigerant burning velocity	CFD results from Scenario 1 suggest that only 33% of the inside of the RTU has velocity < 2.5x the burning velocity for an R-32 leak. For an R-1234yf leak, this value was then scaled down by the ratio of burning velocities for R-1234yf to R-32 (1.5/6.7).	0.33	0.074
Event 4	Multiple	Off	Ignition Source	Condenser	Fast	5T	Spark occurs inside RTU while condenser fan is off, when flammable concentration is present from a fast condenser leak in 5T circuit of 15T RTU	This value is scaled down from that used for a leak in the 10 ton circuit, assuming that flammable concentrations for a leak from the 5 ton circuit would exist for half the time for a leak from the 10 ton circuit.	9.5E-07	1.2E-06
Event 401	Installation	Off	Leak	Evaporator	Fast	Both	Fast evaporator leak occurs in one circuit of 15T RTU during installation	Estimate provided by the AHRI PMS.	5.0E-05	0.00005
Event 406	Installation	Off	Ignition Source	N/A	N/A	N/A	Probability per year that brazing torch is used outside RTU during installation	Based on a weighted average of likelihood a brazing torch is used in installation (5%) and in servicing requiring the RTU to be off (50%).	0.47	0.47
Event 407	Installation	Off	Flammable Concentration	Condenser	Fast	N/A	Fast condenser leak leads to a flammable concentration outside the RTU co-located with brazing torch during installation	Assumed this leak would develop flammable concentrations in 10% of the area surrounding the RTU based on CFD results from Scenario 6. Also assumed 50% chance that brazing torch is in proximity to the condenser compartment of the RTU.	0.05	0.05
Event 434	Installation	Off	Leak	Condenser	Fast	Both	Fast condenser leak occurs in one circuit of 15T RTU during installation	Estimate provided by the AHRI PMS.	0.00015	0.00015

R-32 Code	Mode of Operation	Blower Status	Probability Type	Compartment	Leak Speed	Circuit	Name	Description	R-32	R-1234yf
Event 455	Normal	Off	Leak	Condenser	Fast	Both	Fast condenser leak occurs in one circuit of 15T RTU during normal operation while condenser fan is off	Estimate provided by the AHRI PMS.	9.4E-05	9.4E-05
Event 457	Installation	Off	Time Fraction	N/A	N/A	N/A	Fraction of time spent in installation	Assuming 2 days over 10 years spent in installation, and that of 4 days per year for servicing, 80% of this time is servicing with blower off (giving 3.2 days/year servicing with blower off).	0.0093	0.0093
Event 468	Normal	Off	Flammable Concentration	Condenser	Fast	N/A	Fast condenser leak leads to a flammable concentration outside the RTU co-located with cigarette lighter during normal operation while condenser fan is off	Assumed this leak would develop flammable concentrations in 10% of the area surrounding the RTU based on CFD results from Scenario 6. Also assumed a 1/12 chance that the cigarette is lit in the immediate vicinity of the condenser compartment of the RTU.	0.0083	0.0083
Event 476	Installation	Off	Ignition Source	Condenser	N/A	N/A	Probability per year that cigarette lighter is lit on roof during normal operation while condenser fan is off	Based on assumption that one cigarette will be smoked on roof during normal operation while blower is off during year.	1	1
Event 49	Normal	Off	Time Fraction	N/A	N/A	N/A	Fraction of time with blower off during normal operation	Assumed based on operation of an RTU serving a commercial kitchen for 16 hours per day.	0.33	0.33
Event 491	Multiple	Off	Velocity	N/A	N/A	N/A	Flammable concentrations in the conditioned space are not in a region with velocity > 2.5x the refrigerant burning velocity	CFD results from Scenario 1 suggest that only 10% of the area below the return duct with flammable concentrations in the conditioned space has velocity < 2.5x the burning velocity for an R-32 leak. For an R-1234yf leak, this value was then scaled down by the ratio of burning velocities for R-1234yf to R-32 (1.5/6.7).	0.1	0.022
Event 51	Installation	Off	Ignition Source	N/A	N/A	N/A	Probability that spark occurs inside the conditioned space with blower off	Assumed that walk-in refrigerators and freezers may spark when operating or cycling on, and that spark probability is 3*10E-7 per operating hour. Also assumed a 10% chance the spark has sufficient energy to ignite R-32 and a 0.1% chance the spark has sufficient energy to ignite R-1234yf (from Gradient, 2015, "Risk Assessment...").	0.00035	3.5E-06

R-32 Code	Mode of Operation	Blower Status	Probability Type	Compartment	Leak Speed	Circuit	Name	Description	R-32	R-1234yf
Event 515	Installation	Off	Ignition Source	Condenser	N/A	N/A	Probability per year that spark occurs inside condenser compartment of RTU while condenser fan is off	Based on assumptions that the compressor or condenser fan motors may spark when RTU turns on, and that spark probability is 3×10^{-7} per operating hour. Also assumed a 10% chance the spark has sufficient energy to ignite R-32 and a 0.1% chance the spark has sufficient energy to ignite R-1234yf (from Gradient, 2015, "Risk Assessment...").	3.3E-06	3.3E-08
Event 518	Installation	Off	Flammable Concentration	Condenser	Fast	N/A	Fast condenser leak leads to a flammable concentration outside the RTU co-located with cigarette lighter during installation	Assumed this leak would develop flammable concentrations in 10% of the area surrounding the RTU based on CFD results from Scenario 6. Also assumed 50% chance that cigarette lighter is in proximity to the condenser compartment of the RTU.	0.05	0.05
Event 530	Normal	Off	Time Fraction	N/A	N/A	N/A	Fraction of time spent in normal operation	Assumes that system is running for approximately 362 days per year (all time other than during installation or servicing with blower off).	0.99	0.99
Event 54	Normal	Off	Leak	Condenser	Slow	Both	Slow condenser leak occurs in one circuit of 15T RTU during normal operation while condenser fan is off	Estimate provided by the AHRI PMS.	0.0018	0.0018
Event 545	Installation	Off	Ignition Source	Condenser	Fast	5T	Brazing torch lit inside RTU during installation, when flammable concentration is present from a fast condenser leak in 5T circuit of 15T RTU	This value is scaled down from that used for a leak in the 10 ton circuit, assuming that flammable concentrations for a leak from the 5 ton circuit would exist for half the time for a leak from the 10 ton circuit.	2.9E-06	3.1E-06
Event 561	Installation	Off	Ignition Source	Evaporator	N/A	N/A	Probability per year that spark occurs inside evaporator compartment of RTU	Assumed that the blower motor or other relays may spark when RTU turns on, and that spark probability is 3×10^{-7} per operating hour. Also assumed a 10% chance the spark has sufficient energy to ignite R-32 and a 0.1% chance the spark has sufficient energy to ignite R-1234yf (from Gradient, 2015, "Risk Assessment...").	3.3E-06	3.3E-08
Event 568	Multiple	Off	Flammable Concentration	Evaporator	Fast	N/A	Fast evaporator leak leads to a flammable concentration in the conditioned space co-located with spark source while blower is off	Assumption based on size of plume of flammable concentration seen in CFD Scenario 1 as well as consideration of typical layouts of commercial kitchens.	0.025	0.025

R-32 Code	Mode of Operation	Blower Status	Probability Type	Compartment	Leak Speed	Circuit	Name	Description	R-32	R-1234yf
Event 574	Installation	Off	Ignition Source	Evaporator	Fast	10T	Brazing torch lit inside RTU during installation, when flammable concentration is present from a fast evaporator leak in 10T circuit of 15T RTU	Assumed that a brazing torch would be lit inside the RTU for 60 sec. CFD results from Scenario 1 suggest that flammable concentrations would persist inside the RTU for ~2 min after a fast leak begins.	5.7E-06	6.7E-06
Event 588	Multiple	Off	Flammable Concentration	Evaporator	Slow	N/A	Slow evaporator leak leads to a flammable concentration inside the RTU co-located with spark source while blower is off	CFD results from Scenario 4 suggest that a slow evaporator leak will cause a small pool inside the RTU with flammable concentration. Assumption that there is a 5% chance that this small pool will be co-located with a spark source.	0.05	0.05
Event 59	Normal	Off	Leak	Evaporator	Fast	Both	Fast evaporator leak occurs in one circuit of 15T RTU during normal operation while blower is off	Estimate provided by the AHRI PMS.	3.1E-05	3.1E-05
Event 611	Multiple	Off	Ignition Source	Condenser	Slow	5T	Spark occurs inside RTU while condenser fan is off, when flammable concentration is present from a slow condenser leak in 5T circuit of 15T RTU	This value is scaled down from that used for a leak in the 10 ton circuit, assuming that flammable concentrations for a leak from the 5 ton circuit would exist for half the time for a leak from the 10 ton circuit.	6.3E-05	7.9E-05
Event 617	Multiple	On	No ignition	Evaporator	Fast	N/A	Ignition in the conditioned space from a fast evaporator leak while the blower is on	CFD results from Scenario 3 suggest that flammable concentrations would not develop in the conditioned space as a result of a leak with the blower on.	0	0
Event 625	Normal	On	No ignition	N/A	Slow	N/A	Ignition inside the RTU from a slow leak during normal operation while blower is on	CFD results from Scenarios 3 and 4 suggest that flammable concentrations would not develop in the RTU as a result of a slow evaporator or condenser leak with the blower and condenser fan on.	0	0
Event 647	Installation	Off	Ignition Source	N/A	N/A	N/A	Probability per year that cigarette lighter is lit on roof during installation	Based on assumption that more than one cigarette will be smoked on roof per day during installation.	1	1
Event 66	Multiple	Off	Ignition Source	Evaporator	Fast	5T	Spark occurs in the conditioned space while blower is off, when flammable concentration is present from a fast evaporator leak in 5T circuit of 15T RTU	This value is scaled down from that used for a leak in the 10 ton circuit, assuming that flammable concentrations for a leak from the 5 ton circuit would exist for half the time for a leak from the 10 ton circuit.	1.9E-06	2.4E-06

R-32 Code	Mode of Operation	Blower Status	Probability Type	Compartment	Leak Speed	Circuit	Name	Description	R-32	R-1234yf
Event 668	Normal	Off	Ignition Source	Condenser	Fast	10T	Cigarette lighter lit outside RTU during normal operation while condenser fan is off, when flammable concentration is present from a fast condenser leak in 10T circuit of 15T RTU	Calculated based on assumption that someone might smoke a cigarette on the roof of the commercial kitchen while the blower is not operating only once per year (blower not operating means this would occur when kitchen is not in use). This also assumes that a lighter would be lit for 5 sec to light one cigarette (from Gradient, 2015, "Risk Assessment..."). CFD results from Scenario 6 suggest that flammable concentrations may persist outside the RTU for ~20 sec after a fast leak begins.	7.9E-07	9.5E-07
Event 674	Installation	Off	Ignition Source	Condenser	Slow	10T	Brazing torch lit inside RTU during installation, when flammable concentration is present from a slow condenser leak in 10T circuit of 15T RTU	Calculated based on assumption that brazing torch is used inside the RTU for 60 sec. CFD results from Scenario 4 suggest that a slow leak of R-32 would lead to a small pool of flammable concentration that would persist for ~4000 sec.	0.00013	0.00016
Event 679	Multiple	Off	Ignition Source	Evaporator	Fast	N/A	Gas pilot flame lit in the conditioned space while blower is off, when flammable concentration is present from a fast evaporator leak	Assumed that gas pilots will always be lit.	1	1
Event 690	Normal	Off	Leak	Evaporator	Slow	Both	Slow evaporator leak occurs in one circuit of 15T RTU during normal operation while blower is off	Estimate provided by the AHRI PMS.	0.00059	0.00059
Event 709	Normal	Off	Leak	Evaporator	Fast	Both	Fast evaporator leak occurs in either circuit of 15T RTU during normal operation while blower is off	Estimate provided by the AHRI PMS. This probability is double the probability of a leak in only one circuit.	6.2E-05	6.2E-05
Event 710	Normal	Off	Leak	Evaporator	Fast	Both	Fast evaporator leak occurs in either circuit of 15T RTU during installation	Estimate provided by the AHRI PMS. This probability is double the probability of a leak in only one circuit.	0.0001	0.0001
Event 719	Normal	On	Time Fraction	N/A	N/A	N/A	Fraction of time with blower on during normal operation	Assumed based on operation of an RTU serving a commercial kitchen for 16 hours per day.	0.67	0.67
Event 79	Installation	Off	Ignition Source	Evaporator	Slow	5T	Brazing torch lit inside RTU during installation, when flammable concentration is present from a slow evaporator leak in 5T circuit of 15T RTU	This value is scaled down from that used for a leak in the 10 ton circuit, assuming that flammable concentrations for a leak from the 5 ton circuit would exist for half the time for a leak from the 10 ton circuit.	6.5E-05	8.1E-05

R-32 Code	Mode of Operation	Blower Status	Probability Type	Compartment	Leak Speed	Circuit	Name	Description	R-32	R-1234yf
Event 87	Multiple	Off	Ignition Source	Condenser	Slow	10T	Spark occurs inside RTU while condenser fan is off, when flammable concentration is present from a slow condenser leak in 10T circuit of 15T RTU	CFD results from Scenario 4 suggest that a slow leak of R-32 would lead to a small pool of flammable concentration that would persist for ~4000 sec.	0.00013	0.00016
Event 88	Multiple	Off	Flammable Concentration	Evaporator	Fast	N/A	Fast evaporator leak leads to a flammable concentration in the conditioned space co-located with cigarette lighter while blower is off	Assumed a 5% chance someone lights a cigarette in the area of flammable concentration, based on size of plume of flammable concentration seen in CFD Scenario 1 and typical sizes of commercial kitchens.	0.005	0.005

B.2 Fault Tree Rationale for Scenario C – 25T RTU Serving an Office

Code	Mode of Operation	Blower Status	Probability Type	Compartment	Leak Speed	Name	Description	Probability
Event 124	Multiple	Off	Flammable Concentration	Condenser	Slow	Slow condenser leak leads to a flammable concentration inside the RTU co-located with spark source while condenser fan is off	CFD results from Scenario 4 suggest that a slow condenser leak will cause a small pool inside the RTU with flammable concentration. Assumption that there is a 5% chance that this small pool will be co-located with a spark source.	0.05
Event 139	Multiple	Off	Velocity	N/A	N/A	Flammable concentrations inside the RTU are not in a region with velocity > 2.5x the refrigerant burning velocity	CFD results from Scenario 1 suggest that only 33% of the inside of the RTU has velocity < 2.5x the burning velocity.	0.33
Event 144	Installation	Off	Time Fraction	N/A	N/A	Fraction of time spent in installation	Assuming 2 days over 10 years spent in installation, and that of 4 days per year for servicing, 80% of this time is servicing with blower off (giving 3.2 days/year servicing with blower off).	0.0093
Event 145	Normal	Off	Flammable Concentration	Condenser	Fast	Fast condenser leak leads to a flammable concentration outside the RTU co-located with cigarette lighter during normal operation while condenser fan is off	Assumed this leak would develop flammable concentrations in 10% of the area surrounding the RTU based on CFD results from Scenario 6. Also assumed a 1/12 chance that the cigarette is lit in the immediate vicinity of the condenser compartment of the RTU.	0.0083
Event 161	Normal	Off	Ignition Source	Condenser	Fast	Cigarette lighter lit outside RTU during normal operation while condenser fan is off, when flammable concentration is present from a fast condenser leak in 12.5T circuit of 25T RTU	Calculated based on assumption that someone might smoke a cigarette on the roof of the office while the blower is not operating only once per year (blower not operating means this would occur when office is not in use). This also assumes that a lighter would be lit for 5 sec to light one cigarette (from Gradient, 2015, "Risk Assessment..."). CFD results from Scenario 6 suggest that flammable concentrations may persist outside the RTU for ~40 sec after a fast leak begins.	1.4E-06
Event 163	Normal	Off	Leak	Evaporator	Slow	Slow evaporator leak occurs in 12.5T circuit of 25T RTU during normal operation while blower is off	Estimate provided by the AHRI PMS.	0.0012
Event 171	Normal	On	Time Fraction	N/A	N/A	Fraction of time with blower on during normal operation	Assumed based on operation of an RTU serving an office for 14 hours per day	0.58
Event 180	Installation	Off	Leak	Evaporator	Slow	Slow evaporator leak occurs in 12.5T circuit of 25T RTU during installation	Estimate provided by the AHRI PMS.	0.0019

Code	Mode of Operation	Blower Status	Probability Type	Compartment	Leak Speed	Name	Description	Probability
Event 210	Normal	Off	Ignition Source	Evaporator	Fast	Spark occurs inside RTU while blower is off, when flammable concentration is present from a fast evaporator leak in 12.5T circuit of 25T RTU	CFD results from Scenario 5 suggest that flammable concentrations would persist inside the RTU for ~4 min after a fast leak begins.	7.6E-06
Event 217	Multiple	Off	Ignition Source	Condenser	Fast	Spark occurs inside RTU while condenser fan is off, when flammable concentration is present from a fast condenser leak in 12.5T circuit of 25T RTU	CFD results from Scenario 5 suggest that flammable concentrations would persist inside the RTU for ~2 min after a fast leak begins. This is half the value used for a fast evaporator leak, because it is assumed that the refrigerant will disperse significantly faster in the condenser compartment because refrigerant can rapidly disperse to the air surrounding the RTU.	3.8E-06
Event 220	Installation	Off	Leak	Condenser	Fast	Fast condenser leak occurs in 12.5T circuit of 25T RTU during installation	Estimate provided by the AHRI PMS.	0.0003
Event 226	Normal	Off	Time Fraction	N/A	N/A	Fraction of time with blower off during normal operation	Assumed based on operation of an RTU serving an office for 14 hours per day.	0.42
Event 230	Normal	Off	Leak	Condenser	Slow	Slow condenser leak occurs in 12.5T circuit of 25T RTU during normal operation while condenser fan is off	Estimate provided by the AHRI PMS.	0.0036
Event 234	Normal	Off	Leak	Evaporator	Fast	Fast evaporator leak occurs in 12.5T circuit of 25T RTU during normal operation while blower is off	Estimate provided by the AHRI PMS.	6.0E-05
Event 258	Multiple	Off	Ignition Source	Condenser	Slow	Spark occurs inside RTU while condenser fan is off, when flammable concentration is present from a slow condenser leak in 12.5T circuit of 25T RTU	CFD results from Scenario 4 suggest that a slow leak of R-32 would lead to a small pool of flammable concentration that would persist for ~8000 sec.	0.00025
Event 259	Multiple	Off	Flammable Concentration	Evaporator	Fast	Fast evaporator leak leads to a flammable concentration in the conditioned space co-located with cigarette lighter while blower is off	Assumed a 5% chance someone lights a cigarette in the area of flammable concentration, based on size of plume of flammable concentration seen in CFD Scenario 5 and typical sizes of offices.	0.05
Event 273	Multiple	Off	Ignition Source	Evaporator	Fast	Cigarette lighter lit in the conditioned space while blower is off, when flammable concentration is present from a fast evaporator leak in 12.5T circuit of 25T RTU	CFD results from Scenario 5 suggest that a fast R-32 leak would lead to a small flammable plume that would persist for ~4 min. Also assumed that cigarette lighter would be lit for 5 s per cigarette (from Gradient, 2015, "Risk Assessment...") and that someone might smoke a cigarette in the office with the blower off once per month.	9.5E-06

Code	Mode of Operation	Blower Status	Probability Type	Compartment	Leak Speed	Name	Description	Probability
Event 277	Installation	Off	Ignition Source	N/A	N/A	Probability per year that someone lights a cigarette inside the conditioned space during with blower off	Based on assumption that someone would smoke a cigarette inside the conditioned space once per week with the blower off.	1
Event 280	Installation	Off	Ignition Source	Condenser	Fast	Brazing torch lit outside RTU during installation, when flammable concentration is present from a fast condenser leak in 12.5T circuit of 25T RTU	Assumed that a brazing torch would be lit outside the RTU for 15 sec before and after brazing inside the RTU. CFD results from Scenario 6 suggest that flammable concentrations may persist outside the RTU for ~40 sec after a fast leak begins.	2.2E-06
Event 282	Multiple	Off	Flammable Concentration	Condenser	Slow	Slow condenser leak leads to a flammable concentration inside the RTU co-located with brazing torch while condenser fan is off	CFD results from Scenario 4 suggest that a slow condenser leak will cause a small pool inside the RTU with flammable concentration. Assumed that there is a 5% chance that this small pool will be co-located with the brazing torch.	0.05
Event 307	Multiple	Both	No ignition	Condenser	Slow	Ignition outside the RTU from a slow condenser leak	CFD results from Scenario 4 suggest that a slow condenser leak would not lead to flammable concentrations outside the RTU.	0
Event 315	Multiple	Off	Ignition Source	Evaporator	Slow	Spark occurs inside RTU while blower is off, when flammable concentration is present from a slow evaporator leak in 12.5T circuit of 25T RTU	CFD results from Scenario 4 suggest that a slow leak of R-32 would lead to a small pool of flammable concentration that would persist for ~8000 sec.	0.00025
Event 356	Multiple	Off	Flammable Concentration	N/A	Fast	Fast leak leads to a flammable concentration inside the RTU co-located with ignition source while blower is off	CFD results from Scenario 5 suggest that the entire volume inside the RTU would be filled with a region of flammable concentrations.	1
Event 387	Installation	Off	Ignition Source	Condenser	Fast	Cigarette lighter lit outside RTU during installation, when flammable concentration is present from a fast condenser leak in 12.5T circuit of 25T RTU	Calculated based on assumption that ten cigarettes might be smoked per day on the roof of the office during installation. This also assumes that a lighter would be lit for 5 sec to light one cigarette (from Gradient, 2015, "Risk Assessment..."). CFD results from Scenario 6 suggest that flammable concentrations may persist outside the RTU for ~40 sec after a fast leak begins.	0.00058
Event 388	Multiple	Off	Velocity	N/A	N/A	Flammable concentrations outside the RTU are not in a region with velocity > 2.5x the refrigerant burning velocity	Assumed that velocity outside the RTU would only be < 2.5x the burning velocity in still air (no wind) conditions, which are estimated to occur 6% of the time (from Gradient, 2015, "Risk Assessment...").	0.06

Code	Mode of Operation	Blower Status	Probability Type	Compartment	Leak Speed	Name	Description	Probability
Event 396	Installation	Off	Ignition Source	N/A	N/A	Probability that brazing torch is used inside RTU compartment during installation	Based on a weighted average of likelihood a brazing torch is used in installation (5%) and in servicing requiring the RTU to be off (50%). Assumed that 50% of brazing done in each RTU compartment.	0.24
Event 406	Multiple	Both	No ignition	Evaporator	Slow	Ignition in the conditioned space from a slow evaporator leak	CFD results from Scenario 4 suggest that flammable concentrations would not develop in the conditioned space as a result of a slow leak.	0
Event 411	Installation	Off	Ignition Source	Evaporator	Slow	Brazing torch lit inside RTU during installation, when flammable concentration is present from a slow evaporator leak in 12.5T circuit of 25T RTU	Calculated based on assumption that brazing torch is used inside the RTU for 60 sec. CFD results from Scenario 4 suggest that a slow leak of R-32 would lead to a small pool of flammable concentration that would persist for ~8000 sec.	0.00026
Event 435	Normal	On	No ignition	N/A	Fast	Ignition inside the RTU from a fast leak during normal operation while blower is on	CFD results from Scenario 3 suggest that flammable concentrations would only develop inside the RTU in the immediate vicinity of the leak, and that the velocity with the blower on would be significantly higher than 2.5x the burning velocity.	0
Event 472	Installation	Off	Ignition Source	Condenser	Fast	Brazing torch lit inside RTU during installation, when flammable concentration is present from a fast condenser leak in 12.5T circuit of 25T RTU	Assumed that a brazing torch would be lit inside the RTU for 60 sec. CFD results from Scenario 5 suggest that flammable concentrations would persist inside the RTU for ~2 min after a fast leak begins.	5.7E-06
Event 476	Installation	Off	Flammable Concentration	Evaporator	Slow	Slow evaporator leak leads to a flammable concentration inside the RTU co-located with brazing torch during installation	CFD results from Scenario 4 suggest that a slow condenser leak will cause a small pool inside the RTU with flammable concentration. Assumed that there is a 5% chance that this small pool will be co-located with the brazing torch.	0.05
Event 488	Installation	Off	Leak	Condenser	Slow	Slow condenser leak occurs in 12.5T circuit of 25T RTU during installation	Estimate provided by the AHRI PMS.	0.0057
Event 516	Installation	Off	Ignition Source	N/A	N/A	Probability per year that brazing torch is used outside RTU during installation	Based on a weighted average of likelihood a brazing torch is used in installation (5%) and in servicing requiring the RTU to be off (50%).	0.47
Event 517	Installation	Off	Flammable Concentration	Condenser	Fast	Fast condenser leak leads to a flammable concentration outside the RTU co-located with brazing torch during installation	Assumed this leak would develop flammable concentrations in 10% of the area surrounding the RTU based on CFD results from Scenario 6. Also assumed 50% chance that brazing torch is in proximity to the condenser compartment of the RTU.	0.05

Code	Mode of Operation	Blower Status	Probability Type	Compartment	Leak Speed	Name	Description	Probability
Event 556	Normal	Off	Leak	Condenser	Fast	Fast condenser leak occurs in 12.5T circuit of 25T RTU during normal operation while condenser fan is off	Estimate provided by the AHRI PMS.	0.00019
Event 573	Installation	Off	Ignition Source	Condenser	N/A	Probability per year that cigarette lighter is lit on roof during normal operation while condenser fan is off	Based on assumption that one cigarette will be smoked on roof during normal operation while blower is off during year.	1
Event 585	Multiple	Off	Velocity	N/A	N/A	Flammable concentrations in the conditioned space are not in a region with velocity > 2.5x the refrigerant burning velocity	CFD results from Scenario 1 suggest that only 10% of the area below the return duct with flammable concentrations in the conditioned space has velocity < 2.5x the burning velocity.	0.1
Event 604	Installation	Off	Ignition Source	Condenser	N/A	Probability per year that spark occurs inside condenser compartment of RTU while condenser fan is off	Based on assumptions that the compressor or condenser fan motors may spark when RTU turns on, and that spark probability is 3*10E-7 per operating hour and a 10% chance the spark has sufficient energy to ignite R-32 (from Gradient, 2015, "Risk Assessment...").	3.3E-06
Event 607	Installation	Off	Flammable Concentration	Condenser	Fast	Fast condenser leak leads to a flammable concentration outside the RTU co-located with cigarette lighter during installation	Assumed this leak would develop flammable concentrations in 10% of the area surrounding the RTU based on CFD results from Scenario 6. Also assumed 50% chance that cigarette lighter is in proximity to the condenser compartment of the RTU.	0.05
Event 617	Normal	Off	Time Fraction	N/A	N/A	Fraction of time spent in normal operation	Assumes that system is running for approximately 362 days per year (all time other than during installation or servicing with blower off).	0.99
Event 641	Installation	Off	Ignition Source	Evaporator	N/A	Probability per year that spark occurs inside evaporator compartment of RTU	Assumed that the blower motor or other relays may spark when RTU turns on, and that spark probability is 3*10E-7 per operating hour and 10% chance the spark has sufficient energy to ignite R-32 (from Gradient, 2015, "Risk Assessment...").	3.3E-06
Event 652	Installation	Off	Ignition Source	Evaporator	Fast	Brazing torch lit inside RTU during installation, when flammable concentration is present from a fast evaporator leak in 12.5T circuit of 25T RTU	Assumed that a brazing torch would be lit inside the RTU for 60 sec. CFD results from Scenario 5 suggest that flammable concentrations would persist inside the RTU for ~4 min after a fast leak begins.	9.5E-06
Event 664	Multiple	Off	Flammable Concentration	Evaporator	Slow	Slow evaporator leak leads to a flammable concentration inside the RTU co-located with spark source while blower is off	CFD results from Scenario 4 suggest that a slow evaporator leak will cause a small pool inside the RTU with flammable concentration. Assumption that there is a 5% chance that this small pool will be co-located with a spark source.	0.05

Code	Mode of Operation	Blower Status	Probability Type	Compartment	Leak Speed	Name	Description	Probability
Event 688	Multiple	On	No ignition	Evaporator	Fast	Ignition in the conditioned space from a fast evaporator leak while the blower is on	CFD results from Scenario 3 suggest that flammable concentrations would not develop in the conditioned space as a result of a leak with the blower on.	0
Event 694	Normal	On	No ignition	N/A	Slow	Ignition inside the RTU from a slow leak during normal operation while blower is on	CFD results from Scenarios 3 and 4 suggest that flammable concentrations would not develop in the RTU as a result of a slow evaporator or condenser leak with the blower and condenser fan on.	0
Event 709	Multiple	Off	No ignition	Evaporator	Fast	Ignition in the conditioned space from a spark and fast evaporator leak in 12.5T circuit of 25T RTU while blower is off	Assumed that there is no chance of flammable concentration developing in area of spark source in office based on size of plume of flammable concentration seen in CFD Scenario 5 as well as consideration of typical layouts of offices.	0
Event 711	Installation	Off	Leak	Evaporator	Fast	Fast evaporator leak occurs in 12.5T circuit of 25T RTU during installation	Estimate provided by the AHRI PMS.	0.0001
Event 712	Installation	Off	Ignition Source	N/A	N/A	Probability per year that cigarette lighter is lit on roof during installation	Based on assumption that more than one cigarette will be smoked on roof per day during installation.	1
Event 734	Installation	Off	Ignition Source	Condenser	Slow	Brazing torch lit inside RTU during installation, when flammable concentration is present from a slow condenser leak in 12.5T circuit of 25T RTU	Calculated based on assumption that brazing torch is used inside the RTU for 60 sec. CFD results from Scenario 4 suggest that a slow leak of R-32 would lead to a small pool of flammable concentration that would persist for ~8000 sec.	0.00026

B.3 Fault Tree Rationale for Scenario E – 5T Ground-Mounted RTU with R-32 Serving an Office

Code	Mode of Operation	Blower Status	Probability Type	Compartment	Leak Speed	Name	Description	Probability
Event 107	Normal	Off	Ignition Source	Evaporator	Fast	Spark occurs inside RTU while blower is off, when flammable concentration is present from a fast evaporator leak in 5T circuit of 5T RTU	CFD results from Scenarios 7 and 8 suggest that flammable concentrations would persist inside the RTU for ~1 min after a fast leak begins.	1.9E-06
Event 117	Multiple	Off	Ignition Source	Condenser	Fast	Spark occurs inside RTU while condenser fan is off, when flammable concentration is present from a fast condenser leak in 5T circuit of 5T RTU	CFD results from Scenarios 7 and 8 suggest that flammable concentrations would persist inside the RTU for ~30 s after a fast leak begins. This is half the value used for a fast evaporator leak, because it is assumed that the refrigerant will disperse significantly faster in the condenser compartment because refrigerant can rapidly disperse to the air surrounding the RTU.	9.5E-07
Event 118	Multiple	Off	Ignition Source	Evaporator	Fast	Spark occurs in the conditioned space while blower is off, when flammable concentration is present from a fast evaporator leak in 5T circuit of 5T RTU	CFD results from Scenario 8 suggest that a fast leak of R-32 would lead to a small plume of flammable concentration that would persist for ~1 min.	1.9E-06
Event 120	Installation	Off	Leak	Condenser	Fast	Fast condenser leak occurs in 5T circuit of 5T RTU during installation	Estimate provided by the AHRI PMS.	0.00023
Event 125	Normal	Off	Time Fraction	N/A	N/A	Fraction of time with blower off during normal operation	Assumed based on operation of an RTU serving an office for 14 hours per day.	0.42
Event 129	Installation	Off	Ignition Source	N/A	N/A	Probability that spark occurs inside the conditioned space with blower off	Assumed that 1 mini-fridge and 2 desktop computers may spark when operating or cycling on, and that spark probability is 3×10^{-7} per operating hour and 10% chance the spark has sufficient energy to ignite R-32 (from Gradient, 2015, "Risk Assessment...").	0.00033
Event 131	Normal	Off	Leak	Condenser	Slow	Slow condenser leak occurs in 5T circuit of 5T RTU during normal operation while condenser fan is off	Estimate provided by the AHRI PMS.	0.0018
Event 136	Normal	Off	Leak	Evaporator	Fast	Fast evaporator leak occurs in 5T circuit of 5T RTU during normal operation while blower is off	Estimate provided by the AHRI PMS.	3.1E-05
Event 165	Multiple	Off	Ignition Source	Condenser	Slow	Spark occurs inside RTU while condenser fan is off, when flammable concentration is present from a slow condenser leak in 5T circuit of 5T RTU	CFD results from Scenario 4 suggest that a slow leak of R-32 would lead to a small pool of flammable concentration that would persist for ~2000 sec.	6.3E-05

Code	Mode of Operation	Blower Status	Probability Type	Compartment	Leak Speed	Name	Description	Probability
Event 166	Multiple	Off	Flammable Concentration	Evaporator	Fast	Fast evaporator leak leads to a flammable concentration in the conditioned space co-located with cigarette lighter while blower is off	CFD results from Scenario 8 suggest that flammable concentrations do not develop above the floor, and assumed a cigarette lighter would not be lit on the floor.	0
Event 185	Multiple	Off	Ignition Source	Evaporator	Fast	Cigarette lighter lit in the conditioned space while blower is off, when flammable concentration is present from a fast evaporator leak in 5T circuit of 5T RTU	CFD results from Scenario 8 suggest that a fast R-32 leak would lead to a small flammable plume that would persist for ~1 min. Also assumed that cigarette lighter would be lit for 5 s per cigarette (from Gradient, 2015, "Risk Assessment..."), and that someone might smoke a cigarette in the office with the blower off once per month.	3.8E-06
Event 191	Installation	Off	Ignition Source	N/A	N/A	Probability per year that someone lights a cigarette inside the conditioned space during with blower off	Based on assumption that someone would smoke a cigarette inside the conditioned space once per week with the blower off.	1
Event 193	Installation	Off	Ignition Source	Condenser	Fast	Brazing torch lit outside RTU during installation, when flammable concentration is present from a fast condenser leak in 5T circuit of 5T RTU	Assumed that a brazing torch would be lit outside the RTU for 15 sec before and after brazing inside the RTU. CFD results from Scenario 6 suggest that flammable concentrations may persist outside the RTU for ~10 sec after a fast leak begins.	1.3E-06
Event 195	Multiple	Off	Flammable Concentration	Condenser	Slow	Slow condenser leak leads to a flammable concentration inside the RTU co-located with brazing torch while condenser fan is off	CFD results from Scenario 4 suggest that a slow condenser leak will cause a small pool inside the RTU with flammable concentration. Assumed that there is a 5% chance that this small pool will be co-located with the brazing torch.	0.05
Event 20	Multiple	Off	Velocity	N/A	N/A	Flammable concentrations inside the RTU are not in a region with velocity > 2.5x the refrigerant burning velocity	CFD results from Scenario 1 suggest that only 33% of the inside of the RTU has velocity < 2.5x the burning velocity.	0.33
Event 228	Multiple	Both	No ignition	Condenser	Slow	Ignition outside the RTU from a slow condenser leak	CFD results from Scenario 4 suggest that a slow condenser leak would not lead to flammable concentrations outside the RTU.	0
Event 236	Multiple	Off	Ignition Source	Evaporator	Slow	Spark occurs inside RTU while blower is off, when flammable concentration is present from a slow evaporator leak in 5T circuit of 5T RTU	CFD results from Scenario 4 suggest that a slow leak of R-32 would lead to a small pool of flammable concentration that would persist for ~2000 sec.	6.3E-05
Event 238	Installation	Off	Leak	Evaporator	Fast	Fast evaporator leak occurs in 5T circuit of 5T RTU during installation	Estimate provided by the AHRI PMS.	7.5E-05

Code	Mode of Operation	Blower Status	Probability Type	Compartment	Leak Speed	Name	Description	Probability
Event 250	Installation	Off	Ignition Source	N/A	N/A	Probability per year that cigarette lighter is lit on roof during installation	Based on assumption that more than one cigarette will be smoked on roof per day during installation.	1
Event 26	Installation	Off	Time Fraction	N/A	N/A	Fraction of time spent in installation	Assuming 2 days over 10 years spent in installation, and that of 4 days per year for servicing, 80% of this time is servicing with blower off (giving 3.2 days/year servicing with blower off).	0.0093
Event 27	Normal	Off	Flammable Concentration	Condenser	Fast	Fast condenser leak leads to a flammable concentration outside the RTU co-located with cigarette lighter during normal operation while condenser fan is off	Assumed this leak would develop flammable concentrations in 10% of the area surrounding the RTU based on CFD results from Scenario 6. Also assumed a 50% chance that the cigarette is lit in the immediate vicinity of the condenser compartment of the RTU.	0.05
Event 286	Multiple	Off	Flammable Concentration	Both	Fast	Fast leak leads to a flammable concentration inside the RTU co-located with ignition source while blower is off	CFD results from Scenario 5 suggest that the entire volume inside the RTU would be filled with a region of flammable concentrations.	1
Event 326	Installation	Off	Ignition Source	Condenser	Fast	Cigarette lighter lit outside RTU during installation, when flammable concentration is present from a fast condenser leak in 5T circuit of 5T RTU	Calculated based on assumption that ten cigarettes might be smoked per day on the roof of the office during installation. This also assumes that a lighter would be lit for 5 sec to light one cigarette (from Gradient, 2015, "Risk Assessment..."). CFD results from Scenario 6 suggest that flammable concentrations may persist outside the RTU for ~10 sec after a fast leak begins.	0.00058
Event 327	Multiple	Off	Velocity	N/A	N/A	Flammable concentrations outside the RTU are not in a region with velocity > 2.5x the refrigerant burning velocity	Assumed that velocity outside the RTU would only be < 2.5x the burning velocity in still air (no wind) conditions, which are estimated to occur 6% of the time (from Gradient, 2015, "Risk Assessment...").	0.06
Event 338	Installation	Off	Ignition Source	N/A	N/A	Probability that brazing torch is used inside RTU compartment during installation	Based on a weighted average of likelihood a brazing torch is used in installation (5%) and in servicing requiring the RTU to be off (50%). Assumed that 50% of brazing done in each RTU compartment.	0.24
Event 350	Multiple	Both	No ignition	Evaporator	Slow	Ignition in the conditioned space from a slow evaporator leak	CFD results from Scenario 4 suggest that flammable concentrations would not develop in the conditioned space as a result of a slow leak.	0

Code	Mode of Operation	Blower Status	Probability Type	Compartment	Leak Speed	Name	Description	Probability
Event 355	Installation	Off	Ignition Source	Evaporator	Slow	Brazing torch lit inside RTU during installation, when flammable concentration is present from a slow evaporator leak in 5T circuit of 5T RTU	Calculated based on assumption that brazing torch is used inside the RTU for 60 sec. CFD results from Scenario 4 suggest that a slow leak of R-32 would lead to a small pool of flammable concentration that would persist for ~2000 sec.	6.5E-05
Event 37	Multiple	Off	Flammable Concentration	Evaporator	Fast	Fast evaporator leak leads to a flammable concentration in the conditioned space co-located with spark source while blower is off	CFD results from Scenario 8 suggest that the plume of flammable concentration covers ~50% of the office floor, where spark sources may be present.	0.5
Event 383	Normal	On	No ignition	Both	Fast	Ignition inside the RTU from a fast leak during normal operation while blower is on	CFD results from Scenario 3 suggest that flammable concentrations would only develop inside the RTU in the immediate vicinity of the leak, and that the velocity with the blower on would be significantly higher than 2.5x the burning velocity.	0
Event 429	Installation	Off	Ignition Source	Condenser	Fast	Brazing torch lit inside RTU during installation, when flammable concentration is present from a fast condenser leak in 5T circuit of 5T RTU	Assumed that a brazing torch would be lit inside the RTU for 60 sec. CFD results from Scenario 8 suggest that flammable concentrations would persist inside the RTU for ~30 s after a fast leak begins.	2.9E-06
Event 433	Installation	Off	Flammable Concentration	Evaporator	Slow	Slow evaporator leak leads to a flammable concentration inside the RTU co-located with brazing torch during installation	CFD results from Scenario 4 suggest that a slow condenser leak will cause a small pool inside the RTU with flammable concentration. Assumed that there is a 5% chance that this small pool will be co-located with the brazing torch.	0.05
Event 450	Installation	Off	Leak	Condenser	Slow	Slow condenser leak occurs in 5T circuit of 5T RTU during installation	Estimate provided by the AHRI PMS.	0.0043
Event 48	Normal	Off	Ignition Source	Condenser	Fast	Cigarette lighter lit outside RTU during normal operation while condenser fan is off, when flammable concentration is present from a fast condenser leak in 5T circuit of 5T RTU	Calculated based on assumption that someone might smoke a cigarette on the ground near the RTU while the blower is not operating once per month (blower not operating means this would occur when office is not in use). This also assumes that a lighter would be lit for 5 sec to light one cigarette (from Gradient, 2015, "Risk Assessment..."). CFD results from Scenario 6 suggest that flammable concentrations may persist outside the RTU for ~10 sec after a fast leak begins.	2.2E-06

Code	Mode of Operation	Blower Status	Probability Type	Compartment	Leak Speed	Name	Description	Probability
Event 485	Installation	Off	Ignition Source	N/A	N/A	Probability per year that brazing torch is used outside RTU during installation	Based on a weighted average of likelihood a brazing torch is used in installation (5%) and in servicing requiring the RTU to be off (50%).	0.47
Event 486	Installation	Off	Flammable Concentration	Condenser	Fast	Fast condenser leak leads to a flammable concentration outside the RTU co-located with brazing torch during installation	Assumed this leak would develop flammable concentrations in 10% of the area surrounding the RTU based on CFD results from Scenario 6. Also assumed 50% chance that brazing torch is in proximity to the condenser compartment of the RTU.	0.05
Event 497	Normal	Off	Leak	Condenser	Fast	Fast condenser leak occurs in 5T circuit of 5T RTU during normal operation while condenser fan is off	Estimate provided by the AHRI PMS.	9.4E-05
Event 50	Normal	Off	Leak	Evaporator	Slow	Slow evaporator leak occurs in 5T circuit of 5T RTU during normal operation while blower is off	Estimate provided by the AHRI PMS.	0.00059
Event 521	Installation	Off	Ignition Source	Condenser	Slow	Brazing torch lit inside RTU during installation, when flammable concentration is present from a slow condenser leak in 5T circuit of 5T RTU	Calculated based on assumption that brazing torch is used inside the RTU for 60 sec. CFD results from Scenario 4 suggest that a slow leak of R-32 would lead to a small pool of flammable concentration that would persist for ~2000 sec.	6.5E-05
Event 553	Installation	Off	Ignition Source	N/A	N/A	Probability per year that cigarette lighter is lit on roof during normal operation while condenser fan is off	Based on assumption that one cigarette will be smoked on roof during normal operation while blower is off during year.	1
Event 59	Normal	On	Time Fraction	N/A	N/A	Fraction of time with blower on during normal operation	Assumed based on operation of an RTU serving an office for 14 hours per day	0.58
Event 591	Installation	Off	Ignition Source	Condenser	N/A	Probability per year that spark occurs inside condenser compartment of RTU while condenser fan is off	Based on assumptions that the compressor or condenser fan motors may spark when RTU turns on, and that spark probability is 3×10^{-7} per operating hour and a 10% chance the spark has sufficient energy to ignite R-32 (from Gradient, 2015, "Risk Assessment...").	3.3E-06
Event 597	Installation	Off	Flammable Concentration	Condenser	Fast	Fast condenser leak leads to a flammable concentration outside the RTU co-located with cigarette lighter during installation	Assumed this leak would develop flammable concentrations in 10% of the area surrounding the RTU based on CFD results from Scenario 6. Also assumed 50% chance that cigarette lighter is in proximity to the condenser compartment of the RTU.	0.05

Code	Mode of Operation	Blower Status	Probability Type	Compartment	Leak Speed	Name	Description	Probability
Event 609	Normal	Off	Time Fraction	N/A	N/A	Fraction of time spent in normal operation	Assumes that system is running for approximately 362 days per year (all time other than during installation or servicing with blower off).	0.99
Event 639	Installation	Off	Ignition Source	Evaporator	N/A	Probability per year that spark occurs inside evaporator compartment of RTU	Assumed that the blower motor or other relays may spark when RTU turns on, and that spark probability is 3×10^{-7} per operating hour and 10% chance the spark has sufficient energy to ignite R-32 (from Gradient, 2015, "Risk Assessment...").	3.3E-06
Event 652	Installation	Off	Ignition Source	Evaporator	Fast	Brazing torch lit inside RTU during installation, when flammable concentration is present from a fast evaporator leak in 5T circuit of 5T RTU	Assumed that a brazing torch would be lit inside the RTU for 60 sec. CFD results from Scenario 8 suggest that flammable concentrations would persist inside the RTU for ~1 min after a fast leak begins.	3.8E-06
Event 666	Multiple	Off	Flammable Concentration	Evaporator	Slow	Slow evaporator leak leads to a flammable concentration inside the RTU co-located with spark source while blower is off	CFD results from Scenario 4 suggest that a slow evaporator leak will cause a small pool inside the RTU with flammable concentration. Assumption that there is a 5% chance that this small pool will be co-located with a spark source.	0.05
Event 696	Multiple	On	No ignition	Evaporator	Fast	Ignition in the conditioned space from a fast evaporator leak while the blower is on	CFD results from Scenario 3 suggest that flammable concentrations would not develop in the conditioned space as a result of a leak with the blower on.	0
Event 70	Installation	Off	Leak	Evaporator	Slow	Slow evaporator leak occurs in 5T circuit of 5T RTU during installation	Estimate provided by the AHRI PMS.	0.0014
Event 702	Multiple	Off	Flammable Concentration	Condenser	Slow	Slow condenser leak leads to a flammable concentration inside the RTU co-located with spark source while condenser fan is off	CFD results from Scenario 4 suggest that a slow condenser leak will cause a small pool inside the RTU with flammable concentration. Assumption that there is a 5% chance that this small pool will be co-located with a spark source.	0.05
Event 703	Normal	On	No ignition	N/A	Slow	Ignition inside the RTU from a slow leak during normal operation while blower is on	CFD results from Scenarios 3 and 4 suggest that flammable concentrations would not develop in the RTU as a result of a slow evaporator or condenser leak with the blower and condenser fan on.	0

Code	Mode of Operation	Blower Status	Probability Type	Compartment	Leak Speed	Name	Description	Probability
Event 726	Normal	Off	No ignition	Evaporator	Both	Ignition in the conditioned space from an evaporator leak in an ground-mounted RTU with vertical return ducting during normal operation while blower is off	CFD results from Scenario 7 suggest that flammable concentrations do not develop in the conditioned space from a leak of R-32 from a ground-mounted 5T RTU with a vertical return ducting configuration.	0
Event 727	Multiple	Off	Velocity	Evaporator	Fast	Flammable concentrations in the conditioned space served by a 5T ground-mounted RTU with horizontal return ducting are not in a region with velocity > 2.5x the refrigerant burning velocity	CFD results from Scenarios 1 and 8 suggest that only 25% of the area below the return duct with flammable concentrations in the conditioned space has velocity < 2.5x the burning velocity.	0.25
Event 801	Multiple	Off	Fraction	N/A	N/A	Fraction of ground-mounted RTUs with a horizontal return ducting configuration	Estimated provided by the AHRI PMS.	0.33