

AHRI Standard 410-2001
(Formerly ARI Standard 410-2001)

2001 Standard for
Forced-Circulation
Air-Cooling and
Air-Heating Coils

AHRI Air-Conditioning, Heating,
and Refrigeration Institute

2111 Wilson Boulevard, Suite 500
Arlington, VA 22201, USA
www.ahrinet.org

PH 703.524.8800
FX 703.562.1942

AHRI STANDARD 410-2001 WITH ADDENDUM 3,
Forced-Circulation Air-Heating and Air-Cooling Coils

June 2011

AHRI Standard 410-2001 with Addendum 3, Forced-Circulation Air-Heating and Air-Cooling Coils, is comprised of only the shaded portions shown. The June 2011 Addendum 3 has been incorporated into the already published 2001 version of AHRI Standard 410 to avoid confusion.

Particular additions (shown shaded in the standard), deletions (shown with a strikethrough and shaded in the standard), and corrections (shown shaded in the standard) are as follows:

1. In the following sections “propylene” was added

- | | | |
|---|---|---|
| <ul style="list-style-type: none"> • Certified Ratings item c • Table of Contents Figure 16 • Sections <ul style="list-style-type: none"> ○ 3.1.a ○ 3.1.1.a ○ 3.3.1 • Table 1 • Table 2 • Sections <ul style="list-style-type: none"> ○ 3.3.2 ○ 5.2.7 ○ 5.3.1 ○ 5.4.3 ○ 5.4.3.3 ○ 5.4.3.3.2 | <ul style="list-style-type: none"> ○ 5.4.3.4 ○ 5.4.4 ○ 5.4.8 ○ 6.2.2 Equations <ul style="list-style-type: none"> ▪ (7b), (7c), (8a), (9a), (10a), figure before (15b), (17b), (18b), (19b), (20b), and (24a) | <ul style="list-style-type: none"> ○ 6.3.7 (Form 410-7) • Sections <ul style="list-style-type: none"> ○ 6.4.7 ○ 7.1 <ul style="list-style-type: none"> ▪ K, l, m, n ○ 8.1 <ul style="list-style-type: none"> ▪ $(c_{pg}), (f'), (Q_{gSTD}), (V_g), (w),$ and (x_g) ○ 8.2.2 <ul style="list-style-type: none"> ▪ (ffa) and (g) • Figures 12, 13, 14, 15 and 16 |
|---|---|---|

AHRI STANDARD 410-2001 WITH ADDENDUM 2,
Forced-Circulation Air-Heating and Air-Cooling Coils

May 2005

AHRI Standard 410-2001 with Addendum 2, Forced-Circulation Air-Heating and Air-Cooling Coils, is comprised of only the shaded portions shown. The May 2005 Addendum 2 has been incorporated into the already published 2001 version of AHRI Standard 410 to avoid confusion.

Particular additions (shown shaded in the standard), deletions (~~shown with a strikethrough and shaded in the standard~~), and corrections (shown shaded in the standard) are as follows:

1. In Section 5.2.5.1 the last sentence was replaced with the following :

If the calculated capacity is less than 97.5%, new ratings shall be calculated.

Air-Conditioning, Heating and Refrigeration Institute

2111 Wilson Blvd, Suite 500

Arlington, VA 22201

AHRI STANDARD 410-2001 WITH ADDENDUM 1,
Forced-Circulation Air-Heating and Air-Cooling Coils

May 2002

AHRI Standard 410-2001 with Addendum 1, *Forced-Circulation Air-Heating and Air-Cooling Coils*, is comprised of only the shaded portions shown. The May 2002 Addendum 1 has been incorporated into the already published 2001 version of AHRI Standard 410 to avoid confusion.

Particular additions (shown shaded in the standard), deletions (~~shown with a strikethrough and shaded in the standard~~), and corrections (shown shaded in the standard) are as follows:

1. In Section 6.4.1 the second sentence was replaced with the following:

Published values of air-side pressure drop, under test, shall not be exceeded by more than 10%, or 0.05 in H₂O [12.5 Pa], whichever is greater.

Air-Conditioning, Heating and Refrigeration Institute

2111 Wilson Blvd, Suite 500

Arlington, VA 22201

IMPORTANT

SAFETY DISCLAIMER

AHRI does not set safety standards and does not certify or guarantee the safety of any products, components or systems designed, tested, rated, installed or operated in accordance with nationally recognized safety standards and code requirements appropriate for products covered by this standard/guideline.

AHRI uses its best efforts to develop standards/guidelines employing state-of-the-art and accepted industry practices. AHRI does not certify or guarantee that tests conducted under its standards/guidelines will be non-hazardous or free from risk.

AHRI CERTIFICATION PROGRAM PROVISIONS

Scope of the Certification Program

The Certification Program includes Forced-Circulation Air-Cooling Coils for application under non-frosting conditions, and Forced-Circulation Air-Heating Coils, as defined in Section 3 of the standard.

Coils Included. This program applies only to coils intended:

- a. For field installation (built-up systems)
- b. For use in central station air-conditioning units
- c. For use in central station heating or heating and ventilating units

Exclusion. It does not include:

- a. Coils sold to original equipment manufacturers for inclusion in packaged units
- b. Coils installed in packaged air-conditioning or heating units by the manufacturer
- c. Special coils: Coils of fin or tube material of special configuration not having cataloged performance data

Note: For the purpose of this program, a packaged unit is an assembly of components including coil(s) whose rating is based on a test of the complete assembly.

Certified Ratings

The following Certification Program ratings are verified by test:

- a. Average total cooling or heating capacity, Btu/h [W]
- b. Air pressure drop through coil at standard air density, in H₂O [kPa]
- c. Water, ~~or~~ aqueous ethylene glycol, or aqueous propylene glycol solutions pressure drop through coil (including headers) at average fluid density, ft of fluid [m of fluid]

Note:

This standard supersedes ARI Standard 410-91.

TABLE OF CONTENTS

SECTION	PAGE
Section 1. Purpose.....	1
Section 2. Scope	1
Section 3. Definitions	1
Section 4. Classifications	4
Section 5. Test Requirements	12
Section 6. Rating Requirements.....	18
Section 7. Minimum Data Requirements for Published Ratings.....	33
Section 8. Symbols and Units	34
Section 9. Reference Properties and Conversion Factors.....	37
Section 10. Marking and Nameplate Data	37
Section 11. Conformance Conditions.....	37

TABLES

Table 1. Range of Standard Rating Conditions.....	2
Table 2. Required Laboratory Tests	12
Table 3. Metal Thermal Conductivities	27
Table 4. Conversion Factors	38

FIGURES

Figure 1.	Combined Air Film and Metal Thermal Resistance for Dry Surface vs. Air Film Thermal Resistance for Dry Surface	39
Figure 2.	Total Metal Thermal Resistance of Fin and Tube Assembly Based on Total Surface Effectiveness.....	40
Figure 3.	Rating Data for Steam Coils.....	41
Figure 4.	Rating Data for Hot or Cold Water Sensible Heat Coils.....	42
Figure 5.	Rating Data for Cold Water Cooling and Dehumidifying Coils	43
Figure 6.	Rating Data for Volatile Refrigerant Cooling and Dehumidifying Coils	44
Figure 7.	Temperature Correction Factor for Water Pressure Drop.....	45
Figure 8.	Air-Side Heat Transfer Coefficient Multiplier for Wet Surface	46
Figure 9.	Surface Temperature Chart for Air Cooling and Dehumidifying Coil Application.....	47
Figure 10.	Efficiency of Annular Fins of Constant Thickness	48
Figure 11.	Efficiency of Annular Fins of Constant Area for Heat Flow and Spiral Fins.....	49
Figure 12.	Determination of R_{aW} , f_r and q_t	50
Figure 13.	Crossflow Air-Side Effectiveness	51
Figure 14.	Cross-Counterflow Air-Side Effectiveness	52
Figure 15.	Counterflow Air-Side Effectiveness.....	53
Figure 16.	Aqueous Ethylene Glycol and Aqueous Propylene Glycol Solutions Performance for Smooth Internal Tube Wall Coils	54
Figure 17.	Smooth Internal Tube Wall Heat Transfer Factor for Water.....	55

APPENDICES

Appendix A.	References – Normative.....	56
Appendix B.	References – Informative	57

FORCED-CIRCULATION AIR-COOLING AND AIR-HEATING COILS

Section 1. Purpose

1.1 Purpose. The purpose of this standard is to establish for Forced-Circulation Air-Cooling and Air-Heating Coils: definitions; classifications; test requirements; rating requirements; minimum data requirements for Published Ratings; symbols and units; reference properties and conversion factors; marking and nameplate data; and conformance conditions.

1.1.1 Intent. This standard is intended for the guidance of the industry, including manufacturers, engineers, installers, contractors and users.

1.1.2 Review and Amendment. This standard is subject to review and amendment as technology advances.

Section 2. Scope

2.1 Scope. This standard applies to Forced-Circulation Air-Cooling and Air-Heating Coils, as defined in Section 3 and classified in Section 4 of this standard, and for application under non-frosting conditions.

This standard documents a fundamental means for establishing coil performance by extension of laboratory test data to other operating conditions and other coil sizes and row depths.

Section 3. Definitions

All terms in this document shall follow the standard industry definitions in the current edition of *ASHRAE Terminology of Heating, Ventilation, Air Conditioning and Refrigeration* unless otherwise defined in this section.

3.1 Coil Line. For the purpose of this standard, a coil line is defined as having the following in common:

- a. Fluid (volatile refrigerant, water, steam, or aqueous ethylene glycol, or aqueous propylene glycol solutions)
- b. Tube size, spacing, arrangement (parallel or staggered) or internal construction
- c. Fin configuration (not spacing)

3.1.1 Examples of coil lines are:

- a. *Aqueous Ethylene Glycol or Aqueous Propylene Glycol Solutions.* If conditions b and c of 3.1 are satisfied, the following are types which may be part of one line:
 1. Continuous circuit type
 2. Self-draining type
 3. Cleanable type

- b. *Steam Distributing.*
- c. *Steam Single-Tube.*
- d. *Volatile Refrigerant.* Direct expansion coil with flow controlled by the expansion valve.
- e. *Water.* If conditions b and c of 3.1 are satisfied, the following are types which may be part of one line:
 1. Continuous circuit type
 2. Self-draining type
 3. Cleanable type

3.2 Cooling Capacity. The capacity associated with the change in air enthalpy which includes both the Latent and Sensible Capacities expressed in Btu/h [W].

3.2.1 Latent Capacity. Capacity associated with a change in humidity ratio.

3.2.2 Sensible Capacity. Capacity associated with a change in dry-bulb temperature.

3.3 Forced-Circulation Air Coil. A coil for use in an air stream whose circulation is caused by a difference in pressure produced by a fan or blower.

3.3.1 Forced-Circulation Air-Cooling Coil. A heat exchanger, with or without extended surfaces, through which either cold water, cold aqueous ethylene glycol or aqueous propylene glycol solutions, or volatile refrigerant is circulated, for the purpose of total cooling (sensible cooling plus latent cooling) of a forced-circulation air stream.

Table 1. Range of Standard Rating Conditions

Item	Cooling Coils			Heating Coils		
	Volatile Refrigerant	Cold Water	Cold Ethylene and Propylene Glycol Solution	Steam	Hot Water	Hot Ethylene and Propylene Glycol Solution
Standard air face velocity, std. ft/min [std. m/s]	200 to 800 [1 to 4]	200 to 800 [1 to 4]	200 to 800 [1 to 4]	200 to 1,500 [1 to 8]	200 to 1,500 [1 to 8]	200 to 1,500 [1 to 8]
Entering air dry-bulb temp., °F [°C]	65 to 100 [18 to 38]	65 to 100 [18 to 38]	65 to 100 [18 to 38]	-20 to 100 [-29 to 38]	0.0 to 100 [-18 to 38]	-20 to 100 [-29 to 38]
Entering air wet-bulb temp., °F [°C]	60 to 85 [16 to 29]	60 to 85 [16 to 29]	60 to 85 [16 to 29]	--	--	--
Tube-Side fluid velocity, std. ft/s [std. m/s]	--	¹ 1.0 to 8.0 [0.3 to 2.4]	² 1.0 to 6.0 [0.3 to 1.8]	--	¹ 0.5 to 8.0 [0.1 to 2.4]	² 0.5 to 6.0 [0.1 to 1.8]
Entering fluid temp., °F [°C]	--	35 to 65 [1.7 to 18]	0.0 to 90 [-18 to 32]	--	120 to 250 [49 to 121]	0.0 to 200 [-18 to 93]
Saturated suction refrigerant temp. at coil outlet, °F [°C]	30 to 55 [-1.1 to 13]	--	--	--	--	--

Table 1. Range of Standard Rating Conditions

	Cooling Coils			Heating Coils		
Minimum suction vapor superheat at coil outlet, °F [°C]	6.0 [3.3]	-- --	-- --	-- --	-- --	-- --
Steam pressure at coil inlet, psig [kPa gage]	-- --	-- --	-- --	2.0 to 250.0 [14 to 1723]	-- --	-- --
Maximum superheat in steam at coil inlet, °F [°C]	-- --	-- --	-- --	50 [28]	-- --	-- --
Concentration by mass, %	--	--	10 to 60	--	--	10 to 60
Minimum fin surface temperature, °F [°C]	> 32 [> 0.0]	> 32 [> 0.0]	> 32 [> 0.0]	> 32 [> 0.0]	> 32 [> 0.0]	> 32 [> 0.0]
Minimum tube wall surface temperature, °F [°C]	> 32 [> 0.0]	> 32 [> 0.0]	> ethylene glycol and propylene glycol sol. freeze point	> 32 [> 0.0]	> 32 [> 0.0]	> ethylene glycol and propylene glycol sol. freeze point
¹ On lower limit, Re shall exceed 3100 at t_{wm} . Predicted performance and actual performance in the water velocity range below the tube-side fluid velocity listed above is expected to show variations in excess of currently accepted tolerances for the following reasons: <ol style="list-style-type: none"> 1) Application of coils at low velocity can lead to excessive fouling. 2) Application of coils at low velocity can lead to possible air entrapment. 3) Differences in coil design/type affect the variation in low Re heat transfer coefficient. 						
² On lower limit, Re shall exceed 700 at t_{gm} .						
Note: Numbers in [] are in SI Units						

3.3.2 Forced-Circulation Air-Heating Coil. A heat exchanger, with or without extended surfaces, through which either hot water, hot aqueous ethylene glycol or aqueous propylene glycol solutions, or steam is circulated for the purpose of sensible heating of a forced-circulation air stream.

3.4 Heating Capacity. The capacity associated with the change in dry-bulb temperature expressed in Btu/h [W].

3.5 Laboratory Tests. Tests conducted by a manufacturer on representative coils to determine basic heat transfer and pressure drop characteristics that shall be used in developing Published Ratings.

3.6 Published Ratings. A compilation of the assigned values of those performance characteristics, under stated rating conditions, by which a coil may be chosen to fit its application. These values apply to all coils of like nominal size and type (identification) produced by the same manufacturer. As used herein, the term Published Ratings includes the ratings of all performance characteristics published in specifications, advertising or other literature controlled by the manufacturer or available through an automated rating/selection computer procedure.

3.6.1 Application Ratings. Ratings determined at conditions outside the range of standard rating conditions.

3.6.2 Standard Ratings. Ratings within the range of standard rating conditions (Table 1) and which are accurate representations of test data.

3.7 "Shall" or "Should". Shall or "should" shall be interpreted as follows:

3.7.1 *Shall.* Where "shall" or "shall not" is used for a provision specified, that provision is mandatory if compliance with the standard is claimed.

3.7.2 *Should.* "Should" is used to indicate provisions which are not mandatory but which are desirable as good practice.

3.8 *Standard Air.* Air weighing 0.075 lb/ft³ [1.2 kg/m³] which approximates dry air at 70°F [21°C] and at a barometric pressure of 29.92 in Hg [101.3 kPa].

3.9 *Standard Coil Orientation.* The standard coil position is that of horizontal tubes and vertical coil face with horizontal airflow.

3.10 *Test Series.* A group of related tests performed on the same test coil.

3.11 *Turbulators.* Mechanical devices inside tubes used to increase turbulence of fluids.

Section 4. Classifications

4.1 *Coil Surface Dimensions, Terminology and Surface Calculations.*

4.1.1 *Tube Arrangements and Types of Fin Combinations.*

4.1.1.1 Staggered tubes with:

- a. Continuous flat plate fins
- b. Continuous configured plate fins
- c. Crimped spiral fins
- d. Smooth spiral fins
- e. Flat plate fins on individually-finned tube
- f. Configured plate fins on individually-finned tube

4.1.1.2 Parallel (in-line) tubes with:

- a. Continuous flat plate fins
- b. Continuous configured plate fins
- c. Crimped spiral fins
- d. Smooth spiral fins
- e. Flat plate fins on individually-finned tube
- f. Configured plate fins on individually-finned tube

4.1.2 *Dimensions, Terminology and Fin Efficiency Calculations.* **(Note: Equations in [] are in SI Units)**

In the figures shown in 4.1.2.1, 4.1.2.2 and 4.1.2.3, *H* applies as shown whether channel flanges are turned inward or outward. Where an option is offered in the measurement of any dimension, the same basis shall be used to determine rating data as used in the evaluation of test results.

Dimensions L_f and L_d for a configured fin are determined, at the option of the manufacturer, from the blank fin sheet size prior to forming the configuration providing no edge trimming is performed after forming or from the finished fin size after forming.

4.1.2.1 Staggered tubes and parallel (in-line) tubes (as shown below) with continuous flat plate or configured plate fins.

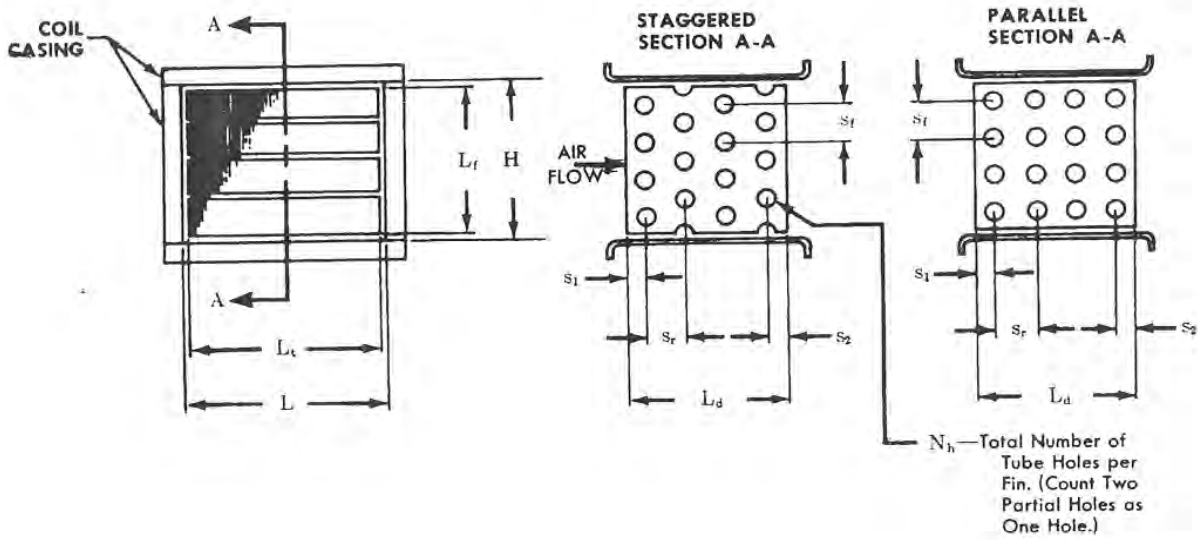

4.1.2.2 Staggered tubes (as shown below) with smooth or crimped spiral fins or with flat plate or configured plate fins on individually-finned tube. Air baffles shown are to be considered optional and H may be the distance between channels as shown in 4.1.2.1.

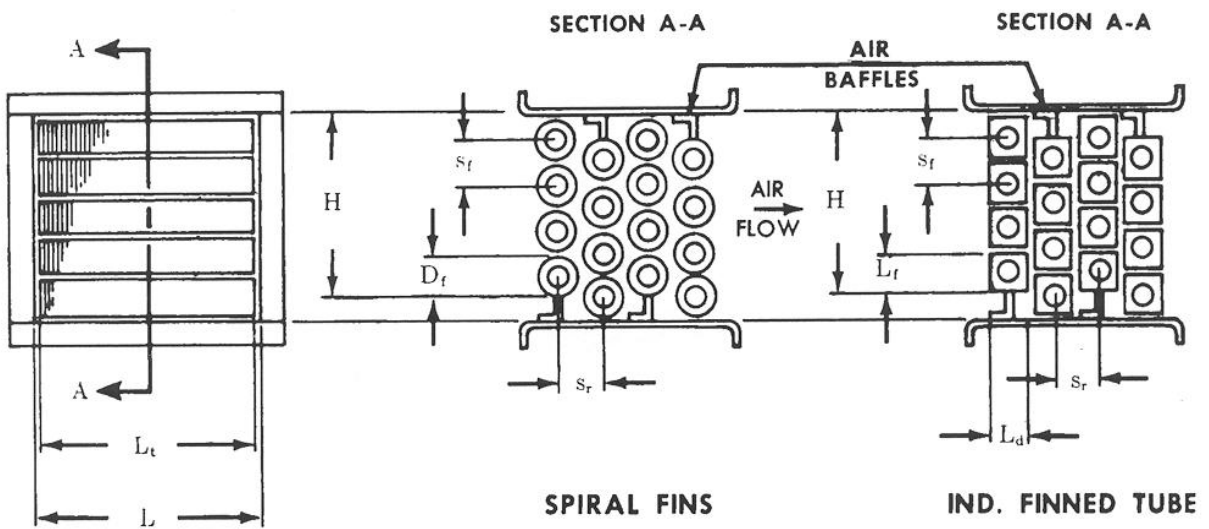

4.1.2.3 Parallel (in-line) tubes (as shown below) with flat plate or configured plate fin on individually-finned tube or with smooth or crimped spiral fins.

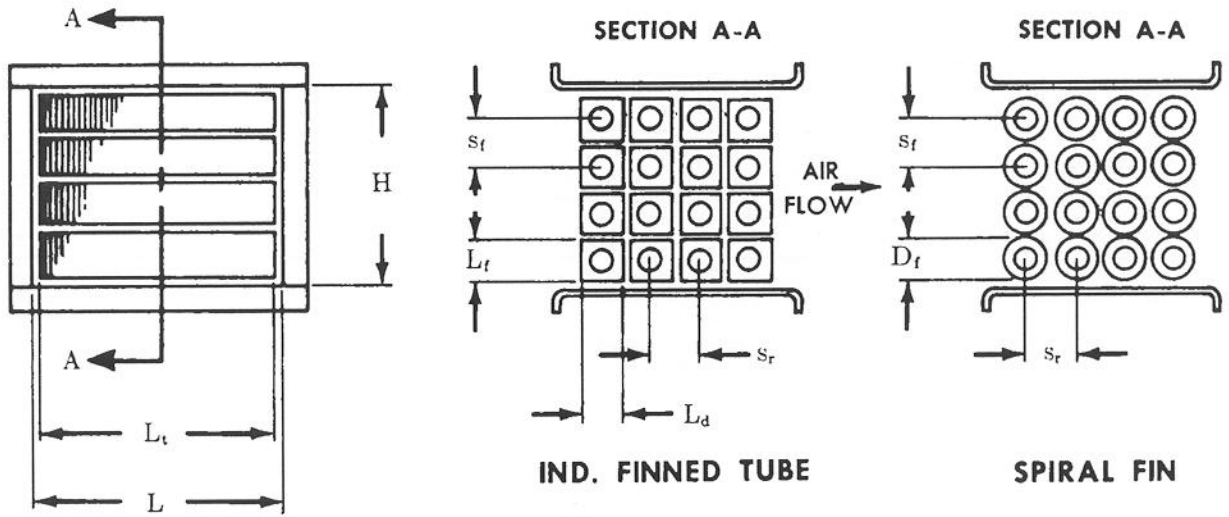

4.1.2.4 Fin-Tube Assemblies.

- a. Plate fins with collars touching adjacent fin

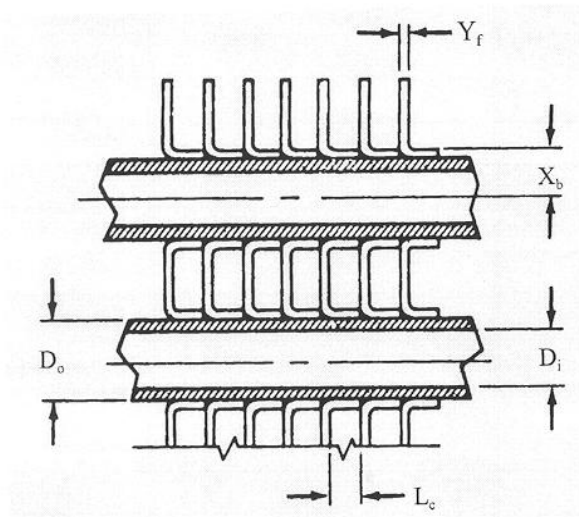

Fin efficiency calculations:

$$x_e = \left(\frac{L_f L_d}{\pi N_t} \right)^{0.5} \text{ for continuous plate fin}$$

$$x_e = \left(\frac{L_f L_d}{\pi} \right)^{0.5} \text{ for individually-finned tube}$$

$$x_b = \frac{D_o + 2Y_f}{2}$$

$$w = x_e - x_b$$

From the curve of $w \left(\frac{f_a}{6k_f Y_f} \right)^{0.5} \left[w \left(\frac{2f_a}{k_f Y_f} \right)^{0.5} \right]$ for various values of x_e/x_b , determine ϕ

(Figure 10)

- b. Plate fins with collars not touching adjacent fin

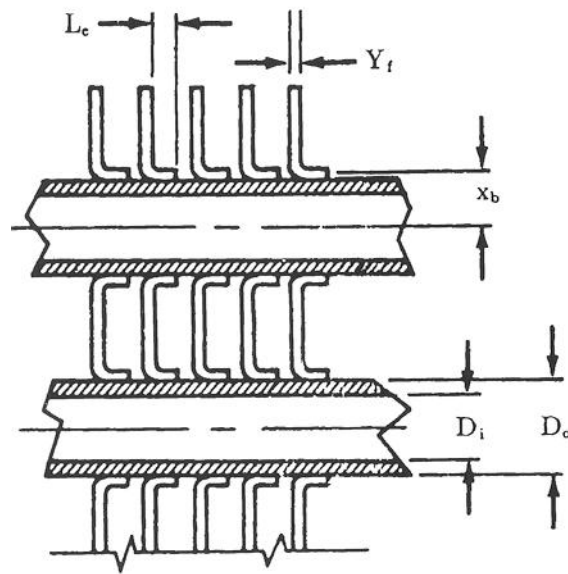

Fin efficiency calculations same as for plate fins with collars touching adjacent fin, except as follows:

$$x_b = \frac{D_o + Y_f}{2}$$

- c. Plate fins without collars

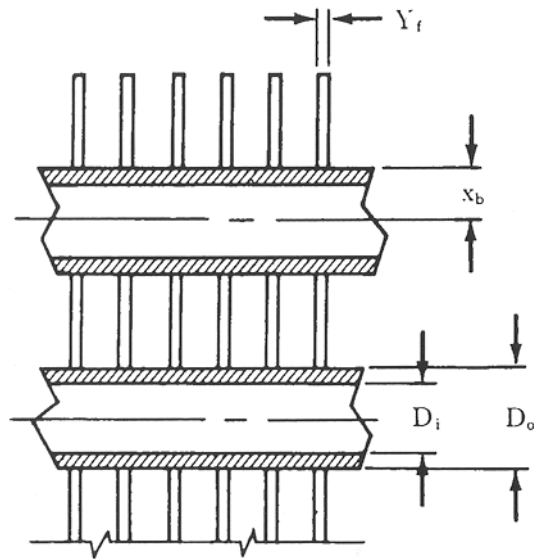

Fin efficiency calculations same as for plate fins with collars touching adjacent fin, except as follows:

$$x_b = \frac{D_o}{2}$$

d. Smooth spiral fins

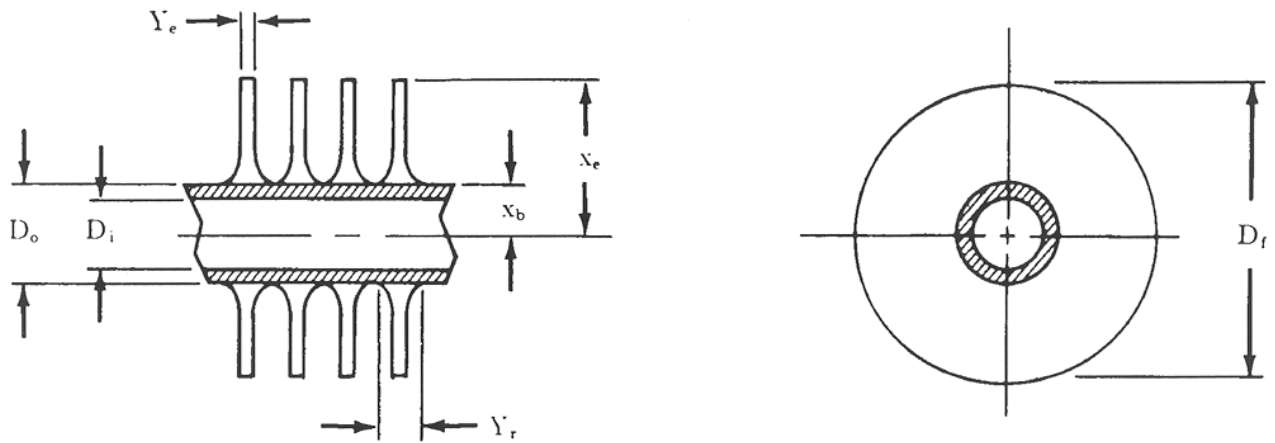

Fin efficiency calculations

$$x_e = \frac{D_f}{2}$$

$$x_b = \frac{D_o}{2}$$

$$w = x_e - x_b$$

From the curve of $w\left(\frac{f_a}{6k_f Y_r}\right)^{0.5} \left[w\left(\frac{2f_a}{k_f Y_r}\right)^{0.5} \right]$ for various values of x_e/x_b , determine ϕ

(Figure 11)

e. Crimped spiral fins

Fin efficiency calculations same as for smooth spiral fins except: $Y_r = \frac{Y_n D_n}{D_o}$

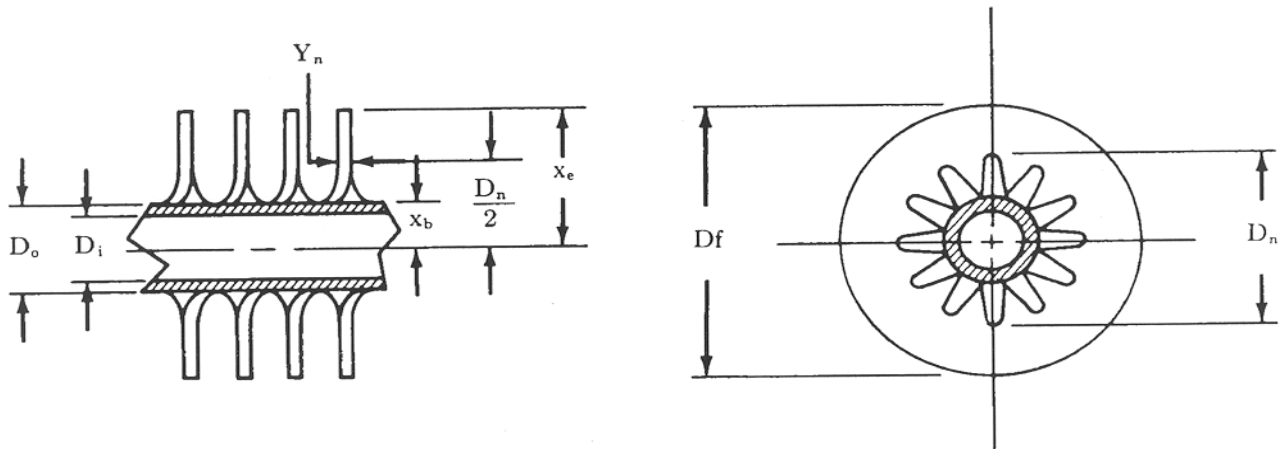

4.1.3 Equations for Determining Coil Areas and Surface Ratio. (Note: Equations in [] are in SI Units)

4.1.3.1 Determination of A_s and A_p

a. Continuous plate fins for staggered and parallel tube arrangements

$$A_s = N_f \left(\frac{L_f L_d}{72} - \frac{N_h (D_o + 2Y_f)^2}{91.68} + \frac{(D_o + 2Y_f)(N_h - N_t)L_c}{45.84} \right)$$

$$= \left[N_f \left(\frac{L_f L_d}{500000} - \frac{N_h (D_o + 2Y_f)^2}{636688} + \frac{(D_o + 2Y_f)(N_h - N_t)L_c}{318344} \right) \right]$$

$$A_p = \frac{N_t D_o L_t - N_t N_f Y_f (D_o - 2L_c)}{45.84}$$

$$= \left[\frac{N_t D_o L_t - N_t N_f Y_f (D_o - 2L_c)}{318344} \right]$$

b. Smooth spiral fins

$$A_s = \frac{N_f N_t}{91.68} (D_f^2 - D_o^2 + 2D_f Y_e) = \left[\frac{N_f N_t}{636688} (D_f^2 - D_o^2 + 2D_f Y_e) \right]$$

$$A_p = \frac{D_o N_t}{45.84} (L_t - N_f Y_r) = \left[\frac{D_o N_t}{318344} (L_t - N_f Y_r) \right]$$

c. Crimped spiral fins

$$A_s = \frac{N_f N_t}{45.84} \left(D_n (D_n - D_o) + \frac{D_f^2 - D_n^2}{2} + D_f Y_e \right) = \left[\frac{N_f N_t}{318344} \left(D_n (D_n - D_o) + \frac{D_f^2 - D_n^2}{2} + D_f Y_e \right) \right]$$

$$A_p = \frac{D_o N_t}{45.84} (L_t - N_f Y_r) = \left[\frac{D_o N_t}{318344} (L_t - N_f Y_r) \right]$$

d. Plate fins on individually-finned tube

$$A_s = N_t N_f \left(\frac{L_f L_d}{72} - \frac{(D_o + 2Y_f)^2}{91.68} + \frac{(L_f + L_d) Y_f}{72} \right) = \left[N_t N_f \left(\frac{L_f L_d}{500000} - \frac{(D_o + 2Y_f)^2}{636688} + \frac{(L_f + L_d) Y_f}{500000} \right) \right]$$

$$A_p = \frac{(D_o + 2Y_f) N_t}{45.84} (L_t - N_f Y_f) = \left[\frac{(D_o + 2Y_f) N_t}{318344} (L_t - N_f Y_f) \right]$$

4.1.3.2 Determination of A_f , A_o , A_i , B , A_{ix} , N_p , N_b and L_e (all cases)

$$A_f = \frac{HL}{144} = \left[\frac{HL}{1000000} \right]$$

$$A_o = A_s + A_p$$

$$A_i = \frac{D_i N_t L_t}{45.84} = \left[\frac{D_i N_t L_t}{318344} \right]$$

$$B = A_o / A_i$$

$$A_{ix} = 0.00545 D_i^2 N_c = [7.85 \times 10^{-7} D_i^2 N_c]$$

$$N_p = N_t / N_c$$

$$N_b = N_p - N_{ih} - 1$$

$$L_e = 0.833(L_s N_p + L_{eb} N_b) \\ = [0.001(L_s N_p + L_{eb} N_b)]$$

Table 2. Required Laboratory Tests

Type of Coil	One Row	Two Rows		Three Rows or More
		In-Line Tubes, Flat Plate Fins	All Other Configurations	
Steam (Distributing tube)	Test	Test	No Test ¹	No Test ¹
Steam (Single tube)	No Test ²	No Test ²	No Test ²	No Test ²
Hot Water	No Test ³	No Test ⁴	No Test ³	No Test ³
All Cooling	Test ⁵	Test	Test ⁵	Test four-row, or five-row, or six-row coil
Aqueous Ethylene Glycol and Aqueous Propylene Glycol Solutions	Test same coil as used for sensible cooling tests			

Where “No Test” is indicated, the manufacturer may, at his option, perform tests to establish performance factors, in which case notes 1-4 below do not apply:

- ¹ Steam ratings may be calculated using data from one-row tests.
- ² The same steam ratings may be used as determined for steam distributing tube coil of same surface geometry.
- ³ The overall thermal resistance, R , may be determined by either of the following procedures:
 - (a) R_{aD} is determined from steam coil tests, assuming a steam-side heat transfer coefficient, f_v , of 2000 Btu / (h·ft²·°F) [11360 W/(m²·°C)]. One-row steam coil tests shall be used to determine R_{aD} for one-row hot water coils. One-row or two-row steam coil tests may be used to determine R_{aD} for two-row hot water coils.
 - (b) R_{aD} is determined from sensible cooling tests. One-row sensible cooling tests shall be used to determine R_{aD} for one-row hot water coils. One-row or two-row sensible cooling tests may be used to determine R_{aD} for two- or more-row hot water coils.
 - (c) For either (a) or (b) above, it is necessary to conduct isothermal water pressure drop tests per 5.4.7.
- ⁴ The air-side thermal resistance, R_{aD} , may be determined as in ³ except that two-row coils shall be used.
- ⁵ A complete set of tests is not required, provided the air-side heat transfer coefficients, f_a , as determined from a sensible cooling water test series, are within 2.5% of those from four- or more-row tests. If this agreement exists for a one-row coil, no test is required for a two-row coil.

Section 5. Test Requirements

5.1 Method for Laboratory Tests of Testing for Rating. Forced-Circulation Air-Cooling and Air-Heating Coils shall be tested in accordance with ANSI/ASHRAE Standard 33.

5.2 Test Coils and Laboratory Tests.

5.2.1 Dimensional Requirements. All cooling and heating coil Laboratory Tests shall be conducted with a representative coil having a face area of 2 to 10 ft² [0.19 to 0.93 m²].

5.2.2 Required Laboratory Tests. See Table 2.

5.2.3 Turbulators. If turbulators are offered as an option to increase the heat transfer coefficient of the fluid inside the coil tubes, only one coil need be tested to establish the correlation between the tube-side heat transfer coefficients, with and without turbulators.

5.2.4 Fin Spacings. Air film heat transfer coefficients and air-side pressure drops for various fin spacings may be determined without testing provided that the interpolated fin spacing is between two spacings previously tested which are not more than 8 fins/in [315 fins/m] apart.

5.2.5 Optional Changes from Test Coil.

5.2.5.1 Changes Requiring No Test. After establishing the original Standard Ratings, one or more of the following changes can be made or offered as an option in a coil line without changing Published Ratings, provided that the calculated influence of any or all of these changes does not reduce the capacity to less than 97.5% of the corresponding Standard Ratings.

- a. Copper fin thickness may be decreased up to 30% below aluminum fin thickness
- b. Fin thickness increase
- c. Tube wall thickness between 0.016 and 0.049 in [0.406 and 1.254 mm]
- d. Tube material, limited to types normally used in comfort air-conditioning, such as copper, red brass, admiralty metal, aluminum and cupro-nickel

If the calculated capacity is less than 97.5%, new ratings shall be calculated and submitted to AHRI for approval.

5.2.5.2 Changes Requiring Tests. After establishing the original Standard Ratings, one or more of the following changes can be made or offered as an option in one or more coil lines with the same surface geometry, provided a sensible cooling or heating Test Series of four face velocities is run and the test capacities are no less than 97.5% of the corresponding Standard Ratings:

- a. Fin material other than copper
- b. Method of bonding
- c. Tube wall thickness outside the range of 5.2.5.1. c
- d. Tube material other than as provided in 5.2.5.1.d
- e. Fin thickness decrease

If the test capacities are less than 97.5% of Standard Ratings, or if other changes such as tube OD, tube spacing, fin configuration or tube arrangement are made, a complete set of Laboratory Tests shall be run and Published Ratings shall be changed accordingly. If the pressure drops are greater than 105% of Standard Ratings, a series of pressure drop tests shall be run and ratings shall be published accordingly.

5.2.6 Refrigerant. Separate Laboratory Tests must be conducted for each refrigerant covered by volatile refrigerant coil ratings.

5.2.7 *Aqueous Ethylene Glycol or Aqueous Propylene Glycol Solutions Coils.* These coils shall have separate Laboratory Tests. Aqueous ethylene glycol or aqueous propylene glycol solution ratings shall not be applied to other fluids.

5.2.8 *Coil Orientations other than Standard.* Information should be available for determining cooling and dehumidifying coil Application Ratings for coil orientations other than the standard orientation (see 3.9). Any such rating shall be substantiated by adequate additional Laboratory Tests.

5.3 *Heat Transfer Rating Variables to be Determined by Laboratory Tests.*

5.3.1 *Range of Heat Transfer Variables.* The range of heat transfer variables over which ratings may be applied shall be limited strictly to the range included in the Laboratory Tests; values shall not be extrapolated outside the range covered in the Laboratory Tests except for the following:

- a. Initial air-to-tube side fluid temperature difference for all coils
- b. Inlet steam pressure for steam coils
- c. Fluid velocity for water and aqueous ethylene glycol or aqueous propylene glycol solution coils
- d. Fluid temperatures for water and aqueous ethylene glycol or aqueous propylene glycol solution coils
- e. Fluid concentrations for aqueous ethylene glycol or aqueous propylene glycol solution coils

5.3.2 The heat transfer variables for the various coil applications covered by this standard, which shall be evaluated for their effect on thermal performance by conducting Laboratory Tests, are described under 5.4.

5.4 *Minimum Requirements for Laboratory Tests.*

5.4.1 *General Scope.*

5.4.1.1 *Air Velocity.* All of the following Test Series for specific coil applications, except under 5.4.3.2.2, 5.4.6.3 and 5.4.7 shall be made with at least four different standard air face velocities, covering the complete rating range of air speed in approximately equally spaced velocity increments on a logarithmic scale.

5.4.1.2 *Fluid Velocity.* For any test with water coils except under 5.4.3.2.2 and 5.4.7, a single fluid velocity should be used in the range from 3 to 6 ft/s [0.9 to 1.8 m/s].

5.4.1.3 *Air-Side Pressure Drop.* The coil air-side pressure drop for all dry and wet surface tests shall be recorded per ANSI/ASHRAE Standard 33.

5.4.2 *Steam Heating Coils.* The purpose of this Test Series is to determine the variation in the overall heat transfer resistance, R , with the standard air face velocity, V_o , and to determine the steam pressure drop through the coil.

5.4.2.1 *Steam Pressure.* For any test, the inlet steam pressure shall be 2 to 10 psig [14 to 69 kPa gage] with an inlet steam superheat as specified in ANSI/ASHRAE Standard 33.

5.4.3 *Water or Aqueous Ethylene Glycol or Aqueous Propylene Glycol Solutions Sensible Cooling Coils.* To assure completely dry air-side surface, the entering fluid temperature, t_{w1} or t_{g1} , for all tests shall be equal to or greater than the entering air dew point temperature, t_{1dp} .

5.4.3.1 *Water Coil with Smooth Internal Tube Walls.* For coil designs with smooth internal tube walls, the water film heat transfer coefficient, f_w , is initially known and shall be calculated from curve fit Equation (8)

shown in Figure 17. Only a single Test Series is required for the purpose of determining the variation in the dry surface air film heat transfer coefficient, f_a , with standard air face velocity, V_a . (See 5.4.1.1 and 5.4.1.2.)

5.4.3.2 Water Coils with Tube Designs Other than Smooth Internal Tube Walls. For coils using tube designs with internal fins, turbulators, etc., both the water and air film heat transfer coefficients, as a function of the respective fluid mass flow rate, are unknown. Two Test Series are required for this type of coil design.

5.4.3.2.1 Test Series Number 1. A single Test Series, as described in 5.4.3.1, shall first be conducted on a heat transfer surface whose design and arrangement are the same in all respects to the rated design except that smooth internal tube walls are used.

5.4.3.2.2 Test Series Number 2. A single Test Series shall be conducted on a heat transfer surface whose design and arrangement are the same as the rated design including internal tube type geometry.

At least four tests with different water velocities are required, covering the complete rating range of water velocity in approximately equally spaced increments on a logarithmic scale. For any test the standard air face velocity may range from 200 to 800 std. ft/min [1 to 4 std. m/s]. Use of high standard air face velocities and close fin spacings is recommended for accuracy reasons.

For this Test Series, knowing the air film heat transfer coefficients, f_a , determined under 5.4.3.2.1, the water film heat transfer coefficients, f_w , may be determined as a function of water velocity and water temperature.

The values of f_w , thus determined, shall be used both for analysis of Laboratory Tests and for rating purposes in lieu of water performance for smooth tube coils from Figure 17.

5.4.3.3 Aqueous Ethylene Glycol or Aqueous Propylene Glycol Solution Coils with Smooth Internal Tube Walls. Two series of tests shall be conducted.

5.4.3.3.1 Test Series Number 1. A single Test Series with water, as described in 5.4.3.1, shall first be conducted on a heat transfer surface whose design and arrangement are the same in all respects to the rated design.

5.4.3.3.2 Test Series Number 2. Test the same coil as in Test Series 1 except that the tube side fluid shall be aqueous ethylene glycol or aqueous propylene glycol solution, 50% ± 5% by mass, at temperatures between 45°F [7.2°C] and 100°F [37.8°C]. A minimum of eleven tests shall be conducted to adequately define a Colburn j-factor versus Re curve as illustrated in Figure 16. Four test points shall be below 2100 Re, three test points between 2100 and 7000 Re and four test points above 7000 Re. All tests shall be conducted at one standard air face velocity between 200 and 800 std. ft/min [1 to 4 std. m/s]. Use of high air velocities and close fin spacings is recommended for accuracy reasons.

For this Test Series, with the air-side heat transfer coefficients, f_a , determined under 5.4.3.3.1, the aqueous ethylene glycol or aqueous propylene glycol solution film heat transfer coefficient, f_g , may be determined. Using the fluid properties in the *ASHRAE Handbook-Fundamentals*, the Colburn j-factor and Re can be calculated and plotted as illustrated in Figure 16. The curve(s) so defined by the test points shall be used for tube-side rating of aqueous ethylene glycol and aqueous propylene glycol solution coils.

The above shall be conducted using a base coil with L_s/D_i ratio between 70 and 90. Ratings for the range of Re between 700 and 7000 shall be based upon the L_s/D_i ratio to the minus 0.4 power in the laminar flow region as shown in Figure 16.

A second coil may be tested at a different length and with a minimum of four test points at Re below 2100 and three test points between 2100 and 7000. The L_s/D_i exponent so determined (laminar region) may then be used for rating purposes. The last three points are used to more clearly define the transition region.

Properties of pure aqueous ethylene glycol and aqueous propylene glycol solutions are representative of most standard industrial inhibited aqueous ethylene glycol solutions, but do not apply to automotive radiator antifreeze solutions.

5.4.3.4 *Aqueous Ethylene Glycol and Aqueous Propylene Glycol Solution Coils with Tube Designs Other Than Smooth Internal Tube Walls.* Two Test Series shall be conducted.

5.4.3.4.1 *Test Series Number 1.* Conduct tests with water identical to those in 5.4.3.3.1.

5.4.3.4.2 *Test Series Number 2.* Proceed identically as in 5.4.3.3.2 except that the coil tubes shall include the internal fins, turbulators, etc. When positive boundary layer interrupters (such as closely spaced wire turbulators or internal ribs at right angle to flow axis, etc.) are used, the L_s/D_i term will not affect the heat transfer coefficient and only the base coil tests are required.

5.4.4 *Hot Water, or Aqueous Ethylene Glycol, or Aqueous Propylene Glycol Solution Heating Coils.* Tests on hot water, or aqueous ethylene glycol, or aqueous propylene glycol solution heating coils are not required (see 5.2.2). Should any be tested, the entering fluid temperature, t_{w1} or t_{g1} , shall be 180°F [82.2°C] or higher and the entering air dry-bulb temperature, t_{1db} , shall not exceed 100°F [37.8°C].

The purpose and minimum testing are the same as given in 5.4.3.1 and 5.4.3.2 for smooth internal tubes and other tube designs, respectively.

5.4.5 *Cold Water Cooling and Dehumidifying Coils.* Two Test Series shall be conducted.

5.4.5.1 *Dry Surface Sensible Heat Tests.* The purpose and minimum testing are identical with those in 5.4.3.1 and 5.4.3.2 for smooth tubes and other tube designs, respectively.

5.4.5.2 *Wet (Dehumidifying) Surface Tests.* The same test coil used for the procedure under 5.4.5.1 shall be employed for these tests.

5.4.5.2.1 *Purpose.* The purpose of this Test Series is to establish whether, under wet surface operating conditions, any adjustments are required in the air film heat transfer coefficients, f_a , as determined for dry surface tests under 5.4.5.1. These adjustments may, or may not, be required, depending upon the particular design and arrangement of the heat transfer surface. Also, the wet surface air-side pressure drop is established by this Test Series.

5.4.5.2.2 *Surface Condition.* To determine air film heat transfer coefficients, f_a , and air-side pressure drop under completely wet surface conditions, each test shall be conducted with the entire air-side surface actively condensing moisture. This operating condition exists when the air-side surface temperature, at all locations throughout the coil, is below the entering air dew point temperature.

5.4.5.2.3 Range of Variables. For each test, the range in each of the following design variables shall fall within the limits listed below:

$$t_{w1} = \text{Entering water temperature: } 35 \text{ to } 55^{\circ}\text{F [1.7 to } 12.8^{\circ}\text{C]}$$

$$t_{1db} - t_{1wb} = \text{Entering wet-bulb depression } \geq 6.0^{\circ}\text{F [3.3}^{\circ}\text{C]}$$

$$q_s/q_t = \text{Air sensible heat ratio } \leq 0.75$$

$$t_{2wb} - t_{w1} \geq 5.0 \text{ F [2.8}^{\circ}\text{C]}$$

5.4.6 Volatile Refrigerant Cooling and Dehumidifying Coils. A complete Test Series, as outlined below, shall be run with each volatile type refrigerant for which tests are required (see 5.2.6). Three series of tests shall be run on the same prototype coil or coils.

5.4.6.1 Dry Surface Tests. Using cold water, the first series of tests shall be conducted as outlined under 5.4.5.1. This requirement may be deleted if tests under 5.4.5.1 were previously completed.

5.4.6.2 Wet Surface Test. Using cold water, a second series of tests shall be conducted as outlined under 5.4.5.2. This requirement may be deleted if tests under 5.4.5.2 were previously completed.

5.4.6.3 Volatile Refrigerant Tests. Using volatile refrigerant, the third series of tests shall be conducted with at least two different lengths of refrigerant circuits for a given coil:

- a. A circuit closely approximating the maximum equivalent length used in the line of rated coils
- b. A circuit whose length is no greater than one-third of the maximum equivalent length used in the line of rated coils

For each of the two refrigerant circuit lengths, a minimum of four tests are required. These are to cover the complete range of refrigerant loading per circuit in approximately equal increments of capacity on a logarithmic scale, and conducted with a constant liquid temperature in the range of 108 to 112°F [42.2 to 44.4°C] entering the control device and up to 55°F [12.8°C] saturated coil outlet refrigerant temperature.

5.4.6.4 Evaluation. The above eight tests shall serve to evaluate the effects of refrigerant loading per circuit on both the coil circuit saturated refrigerant pressure drop and the refrigerant evaporating film heat transfer coefficient.

5.4.6.5 General Recommendations. For any test, the standard air face velocity, V_a , may range from 200 to 800 std. ft/min [1 to 4 std. m/s]. The surface shall be operated either completely dry or completely wet in order to simplify the data reduction procedure.

5.4.6.6 Outlet Superheat. Refrigerant outlet vapor superheat, for any test, is to be maintained per ANSI/ASHRAE Standard 33.

5.4.7 Isothermal Water Pressure Drop For All Water Coils. For each water coil tested, the water pressure drop through the coil shall be determined under isothermal operating conditions. Tests shall be made with at least four different water velocities as specified in 5.4.3.2.2.

5.4.8 Isothermal Pressure Drop for Ethylene Glycol or Aqueous Propylene Glycol Solution Coils. For each ethylene or propylene glycol solution coil tested, the pressure drop through the coil shall be determined under isothermal operating conditions. Conduct at least four tests at Re below 1000 and at least four tests at Re above 4000. To

complete the pressure drop curve, extrapolate the two resulting data curves to find the intersection in the 1000 to 4000 Re region. Additional tests may be run in the 1000 to 4000 Re region to complete the pressure drop curve.

Section 6. Rating Requirements

6.1 Ratings. Ratings for Forced-Circulation Air-Cooling and Air-Heating Coils consist of Standard Ratings and Application Ratings used in the selection or application of coils. They are usually given for a range of conditions encountered in practice, so that the rating at any desired condition may be selected directly or by interpolation.

6.1.1 Ratings shall include pressure drop data and performance characteristics produced under specified conditions, or means for calculating specific coil requirements.

6.1.2 Ratings may be presented in the form of curves, tables, charts or automated rating/selection computer procedures.

6.1.3 Ratings shall be developed using basic performance characteristics obtained from Laboratory Tests in accordance with this standard.

6.2 Heat Transfer Equations for Laboratory Test Reduction and for Ratings. The initial test data reduction procedure and calculations for the determination of:

- a. Both fluid flow rates
- b. The average or rated sensible and/or total heat transfer capacity
- c. Entering and leaving fluid conditions
- d. Both fluid pressure drops

are given in ANSI/ASHRAE Standard 33 both for air sensible heating or cooling and air cooling and dehumidifying coils.

6.2.1 Metal Thermal Resistance of External Fins and Tube Wall for All Applications. The total metal thermal resistance, R_m , to heat flow through the external fins and the prime tube wall is calculated as follows:

$$R_m = R_f + R_t \tag{1}$$

where the constant tube metal thermal resistance, R_t , is,

$$R_t = \frac{BD_i}{24k_t} \left(\ln \frac{D_o}{D_i} \right) = \left[\frac{BD_i}{2k_t} \left(\ln \frac{D_o}{D_i} \right) \right]$$

and where the variable fin metal thermal resistance, R_f , based on total external surface effectiveness, η , is

$$R_f = \left(\frac{1-\eta}{\eta} \right) (R_{aD}) \quad \text{(for dry surface)} \tag{2}$$

$$R_f = \left(\frac{1-\eta}{\eta} \right) \left(R_{aW} \frac{c_p}{m''} \right) \quad \text{(for wet surface)} \tag{2a}$$

$$\eta = \frac{\phi A_s + A_p}{A_o} \quad (3)$$

The influence of m'' on R_{aw} , as shown in Equation (2a), is based on a derivation by Brown (Reference A1.7) which was applied to wet coil theory by Ware-Hacha (Reference A1.18) to determine its implicit effect on R_f .

6.2.2 Sensible Heat Air Coils. Equations relating the average or rated sensible heat capacity, q_s , to both air- and tube-side fluid, by a material heat balance, are given in applicable paragraphs in ANSI/ASHRAE Standard 33.

The identical sensible heat capacity, q_s , corresponding to this material heat balance, in terms of the overall heat transfer rate between fluids is:

$$q_s = \frac{A_o \Delta t_m}{R} \quad (4)$$

where, for clean surfaces,

$$R = R_{aD} + R_m + R_w \text{ (or } R_v \text{ or } R_g \text{ or } R_r) \quad (5)$$

$$R_{aD} + R_m = \frac{R_{aD}}{\eta} + R_t \quad (6)$$

and, for cold and hot water Laboratory Test reduction ($R_{ffa} = 0$) and ratings (manufacturer may chose to use fouling factor allowances, see Reference A.1.2 for typical values):

$$R_w = B \left(\frac{1}{f_w} + R_{ffa} \right) \quad (7)$$

For steam:

$$R_v = \frac{B}{f_v} \quad (7a)$$

For cold and hot aqueous ethylene glycol or aqueous propylene glycol solution Laboratory Test reduction ($R_{ffa} = 0$) and ratings (manufacturer may chose to use fouling factor allowances, see Reference A1.2 for typical values):

$$R_g = B \left(\frac{1}{f_g} + R_{ffa} \right) \quad (7b)$$

For volatile refrigerant:

$$R_r = \frac{B}{f_r} \quad (7c)$$

For all water coils with surface designs employing *smooth internal tube walls*, the tube-side water film heat transfer coefficient, f_w , where the Re exceeds 3100, is determined using the curve fit Equation (8) shown in Figure 17 .

For water coils using tube geometries other than smooth internal walls, the tube-side water film heat transfer coefficient, f_w , is determined by test as in 5.4.3.2.2. For steam coils, the tube-side steam film heat transfer coefficient, f_v , is evaluated as described in Table 2, note 3. For volatile refrigerant coils, the tube-side refrigerant film heat transfer coefficient, f_r , is evaluated as described in 6.3.6. For aqueous ethylene glycol or aqueous propylene glycol solution coils, the tube-side aqueous ethylene glycol or aqueous propylene glycol solution film heat transfer coefficient, f_g , is evaluated as described in 6.4.7.

For water coils:

$$V_w = \frac{w_w}{224500A_{ix}} = \left[\frac{w_w}{998.927A_{ix}} \right] \quad (8)$$

For aqueous ethylene glycol or aqueous propylene glycol solution coils:

$$V_g = \frac{w_g}{3600\rho_g A_{ix}} = \left[\frac{w_g}{\rho_g A_{ix}} \right] \quad (8a)$$

For counterflow cold water coils:

$$\Delta t_m = \frac{(t_{1db} - t_{w2}) - (t_{2db} - t_{w1})}{\ln\left(\frac{t_{1db} - t_{w2}}{t_{2db} - t_{w1}}\right)} \quad (9)$$

For counterflow cold aqueous ethylene glycol or aqueous propylene glycol solution coils:

$$\Delta t_m = \frac{(t_{1db} - t_{g2}) - (t_{2db} - t_{g1})}{\ln\left(\frac{t_{1db} - t_{g2}}{t_{2db} - t_{g1}}\right)} \quad (9a)$$

For counterflow hot water coils:

$$\Delta t_m = \frac{(t_{w2} - t_{1db}) - (t_{w1} - t_{2db})}{\ln\left(\frac{t_{w2} - t_{1db}}{t_{w1} - t_{2db}}\right)} \quad (10)$$

For counterflow hot aqueous ethylene glycol or aqueous propylene glycol solution coils:

$$\Delta t_m = \frac{(t_{g2} - t_{1db}) - (t_{g1} - t_{2db})}{\ln\left(\frac{t_{g2} - t_{1db}}{t_{g1} - t_{2db}}\right)} \quad (10a)$$

For thermal counterflow volatile refrigerant coils:

$$\Delta t_m = \frac{(t_{1db} - t_{r1}) - (t_{2db} - t_{rc2g})}{\ln\left(\frac{t_{1db} - t_{r1}}{t_{2db} - t_{rc2g}}\right)} \quad (11)$$

For steam coils (single-tube):

$$\Delta t_m = \frac{(t_{2db} - t_{1db})}{\ln\left(\frac{t_{vmg} - t_{1db}}{t_{vmg} - t_{2db}}\right)} \quad (12)$$

For steam coils (distributing):

$$\Delta t_m = \frac{(t_{2db} - t_{1db})}{\ln\left(\frac{t_{v2g} - t_{1db}}{t_{v2g} - t_{2db}}\right)} \quad (12a)$$

For other tube circuiting arrangements see 6.4.2.

6.2.3 Cooling and Dehumidifying Air Coils. The method used in this standard to calculate wet surface coil performance is, with some modifications, similar to the method outlined in Technical Standard BCMI-TS4044 (Reference A1.6) with basic theory as presented by McElgin and Wiley (Reference A1.15). Other investigators by converting the basic dual potential, used in the method described in this standard, to an equivalent single potential, have developed other similar rating methods (Reference A1.18 and Appendix B).

6.2.3.1 Sensible Heat Ratio. The ratio of air-side sensible-to-total heat is calculated as follows:

$$q_s/q_t = \frac{c_p(t_{1db} - t_{2db})}{h_1 - h_2} \quad (13)$$

The ratio, q_s/q_t , is used as an index to define the type of procedure required for calculating ratings as follows:

- a. If $q_s/q_t < 0.95$, use the equations listed in the remainder of 6.2.3.
- b. If $q_s/q_t \geq 0.95$, use the conventional dry surface, sensible heat transfer equations listed under 6.2.2.

6.2.3.2 Total Heat Capacity or Total External Surface Area Requirements. Depending upon operating conditions, the coil air-side surface may operate either completely wet or a portion of the coil may operate with dry surface. For the case where all surface is completely wet, all surface temperatures, t_s , of the coil are below the entering air dew-point temperature, t_{1dp} . For the case where the surface temperatures, t_s , of a part of the coil are above the entering air dew-point temperature, t_{1dp} , this portion of the coil surface area, A_D , operates dry with the remainder of the coil surface area, A_W , wet or actively condensing moisture. For

this latter case, the coil surface area requirements are separately calculated for the dry and wet parts of the coil.

For the wet part of the coil, the wet surface area, A_w , or the corresponding total heat capacity, q_{tw} , is calculated by using the mean air enthalpy difference between the air stream and that corresponding to the coil surface temperature.

Equations relating the average or rated total heat capacity, q_t , to both air- and tube-side fluid, by a material heat balance, are given in applicable paragraphs of ANSI/ASHRAE Standard 33. The identical total heat capacity, q_t , corresponding to this material heat balance, for the general case where a portion of the coil surface area operates dry is:

$$q_t = \frac{A_D \Delta t_m}{R} + \frac{A_W \Delta h_m}{c_p R_{aW}} \tag{14}$$

where:

$$\frac{A_D \Delta t_m}{R} = q_{tD} = \text{Dry surface capacity}$$

$$\frac{A_W \Delta h_m}{c_p R_{aW}} = q_{tW} = \text{Wet surface capacity}$$

$$q_{tD} + q_{tW} = q_t = \text{Total heat capacity required}$$

The q_{tD} term in Equation (14) is omitted if the entire air-side surface is actively condensing moisture.

For counterflow water coils:

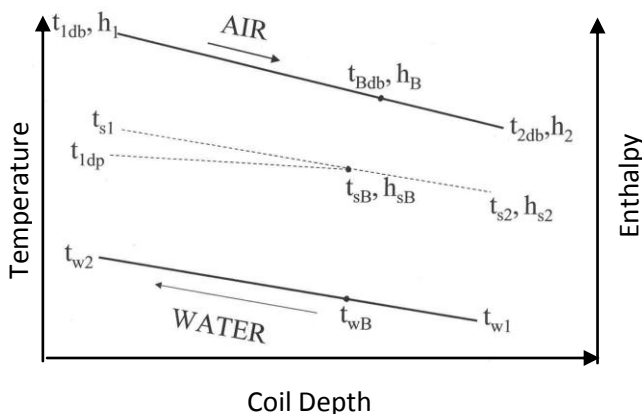

Graphic representation of Equations (15) and (16)

$$\Delta t_m = \frac{(t_{1db} - t_{w2}) - (t_{Bdb} - t_{wB})}{\ln\left(\frac{t_{1db} - t_{w2}}{t_{Bdb} - t_{wB}}\right)} \quad (15)$$

$$\Delta h_m = \frac{(h_B - h_{sB}) - (h_2 - h_{s2})}{\ln\left(\frac{h_B - h_{sB}}{h_2 - h_{s2}}\right)} \quad (16)$$

For thermal counterflow volatile refrigerant coils:

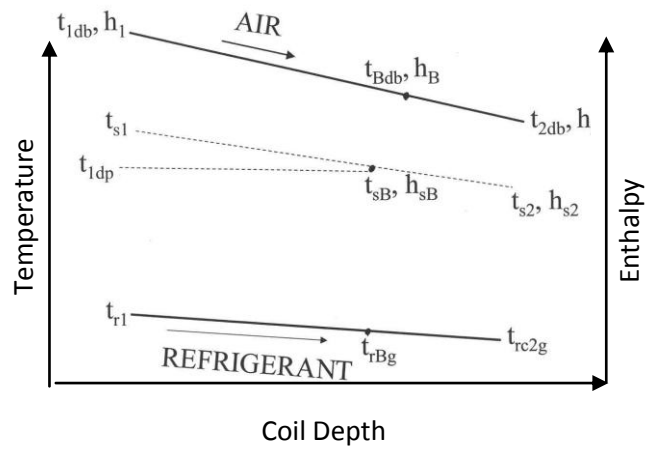

Graphic representation of Equations (15a) and (16a)

$$\Delta t_m = \frac{(t_{1db} - t_{r1}) - (t_{Bdb} - t_{rBg})}{\ln\left(\frac{t_{1db} - t_{r1}}{t_{Bdb} - t_{rBg}}\right)} \quad (15a)$$

$$\Delta h_m = \frac{(h_B - h_{sB}) - (h_2 - h_{s2})}{\ln\left(\frac{h_B - h_{sB}}{h_2 - h_{s2}}\right)} \quad (16a)$$

For aqueous ethylene glycol or aqueous propylene glycol solution coils:

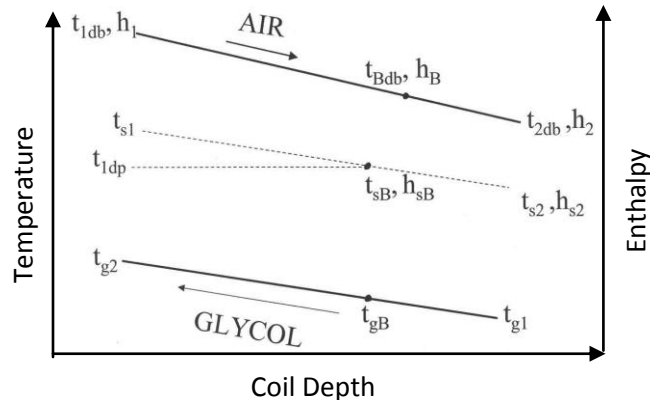

Graphic representation of Equations (15b) and (16b)

$$\Delta t_m = \frac{(t_{1db} - t_{g2}) - (t_{Bdb} - t_{gB})}{\ln\left(\frac{t_{1db} - t_{g2}}{t_{Bdb} - t_{gB}}\right)} \tag{15b}$$

$$\Delta h_m = \frac{(h_B - h_{sB}) - (h_2 - h_{s2})}{\ln\left(\frac{h_B - h_{sB}}{h_2 - h_{s2}}\right)} \tag{16b}$$

In the above equations, h_{s2} refers to the enthalpy of saturated air at the surface temperature for the leaving air-side of the coil.

6.2.3.3 The Coil Characteristic. The coil characteristic is in terms of the individual thermal resistances:

$$C = \frac{R_m + R_w}{c_p R_{aW}} \text{ (for water)} \tag{17}$$

$$C = \frac{R_m + R_r}{c_p R_{aW}} \text{ (for volatile refrigerant)} \tag{17a}$$

$$C = \frac{R_m + R_g}{c_p R_{aW}} \text{ (for aqueous ethylene glycol or aqueous propylene glycol solution)} \tag{17b}$$

And also, for any point condition within the wet surface region, such as the terminal differences, the coil characteristic is used to obtain the correct division between the air-side enthalpy difference, $h-h_s$, and tube-side temperature difference, t_s-t_w , t_s-t_{rg} , or t_s-t_g , as follows:

$$C = \frac{t_s - t_w}{h - h_s} \text{ (for water)} \tag{18}$$

$$C = \frac{t_s - t_{rg}}{h - h_s} \text{ (for volatile refrigerant)} \quad (18a)$$

$$C = \frac{t_s - t_g}{h - h_s} \text{ (for aqueous ethylene glycol or aqueous propylene glycol solution)} \quad (18b)$$

C is calculated from Equations (17), (17a) or (17b) using known values of R_{aw} , R_m and R_w , R_r or R_g . Then with known values of h and t_w , t_r or t_g at a given position within the wet surface region, the corresponding values of t_s and h_s may be exactly calculated from Equations (18), (18a) or (18b) by trial and error using air enthalpy tables. A direct method for finding t_s and h_s , to closely approximate the exact solution given by Equations (18), (18a) or (18b) may be obtained by use of a universal Surface Temperature Chart, such as shown in Figure 9.

6.2.3.4 Dry-Wet Boundary Determination for Partially Dry Surface. Under operating conditions where a portion of the coil is operating dry, the boundary condition between the dry and wet surface regions is established by calculating the air stream enthalpy, h_B , at this point.

For counterflow water coils:

$$h_B = \frac{t_{1dp} - t_{w2} + yh_1 + Ch_{1dp}}{C + y} \quad (19)$$

For thermal counterflow volatile refrigerant coils:

$$h_B = \frac{t_{1dp} - t_{r1} + yh_1 + Ch_{1dp}}{C + y} \quad (19a)$$

For aqueous ethylene glycol or aqueous propylene glycol coils:

$$h_B = \frac{t_{1dp} - t_{g2} + yh_1 + Ch_{1dp}}{C + y} \quad (19b)$$

where:

$$y = \frac{t_{w2} - t_{w1}}{h_1 - h_2} \text{ (for water coils)} \quad (20)$$

$$y = \frac{t_{r1} - t_{rc2g}}{h_1 - h_2} \text{ (for volatile refrigerant coils)} \quad (20a)$$

$$y = \frac{t_{g2} - t_{g1}}{h_1 - h_2} \text{ (for aqueous ethylene glycol or aqueous propylene glycol solution coils)} \quad (20b)$$

If $h_B \geq h_1$, the entire coil surface area is wet and $A_D = 0$. Only the wet surface area, A_W , is calculated for this condition. If $h_B < h_1$, part of the surface is operating dry. For this condition, the dry, A_D , and wet, A_W , surface areas are separately calculated.

The air dry-bulb temperature at the dry-wet boundary is:

$$t_{Bdb} = t_{1db} - \left(\frac{h_1 - h_B}{c_p} \right) \quad (21)$$

The total heat load for the dry surface region is:

$$q_{tD} = 60w_a(h_1 - h_B) = [1000w_a(h_1 - h_B)] \quad (22)$$

The total heat load for the wet surface region is:

$$q_{tW} = q_t - q_{tD} \quad (23)$$

The cold water temperature at the dry-wet boundary with counterflow coils is:

$$t_{wB} = t_{w2} - \left(\frac{q_{tD}}{w_w c_{pw}} \right) \quad (24)$$

The cold aqueous ethylene glycol or aqueous propylene glycol solution temperature with counterflow coils is:

$$t_{gB} = t_{g2} - \left(\frac{q_{tD}}{w_g c_{pg}} \right) \quad (24a)$$

6.2.3.5 Determination of Leaving Air Dry-Bulb Temperature. If $t_{\square} \geq t_{1dp}$, the coil surface is dry and the leaving air dry-bulb temperature shall be calculated using the method described in 6.2.2. For wet or partially wet coil surface, the leaving air dry-bulb temperature, t_{2db} , shall be calculated as follows:

$$c = \frac{A_o}{60c_p w_a R_{aD}} = \frac{A_o}{14.58w_a R_{aD}} = \left[\frac{A_o}{1000c_p w_a R_{aD}} \right] = \left[\frac{A_o}{1017w_a R_{aD}} \right] \quad (25)$$

and also:

$$e^{-c} = \frac{h_2 - h_{\bar{s}}}{h_1 - h_{\bar{s}}} = \frac{t_{2db} - t_{\bar{s}}}{t_{1db} - t_{\bar{s}}} \quad (26)$$

The saturated air enthalpy, $h_{\bar{s}}$ corresponding to the effective coil surface temperature, $t_{\bar{s}}$ is:

$$h_{\bar{s}} = h_1 - \left(\frac{h_1 - h_2}{1 - e^{-c}} \right) \tag{27}$$

The leaving air dry-bulb temperature, t_{2db} , is then calculated as follows:

$$t_{2db} = t_{\bar{s}} + (t_{1db} - t_{\bar{s}})e^{-c} \tag{28}$$

6.2.3.6 Determination of Sensible and Latent Heat Capacities. The air-side sensible, q_s , and total, q_t , heat capacities are calculated from applicable equations in ANSI/ASHRAE Standard 33.

6.3 Reduction of Laboratory Test Data to Determine Parameters for Ratings. The Forms referenced herein are contained in AHRI OM-410 Addendum (Reference A1.3).

6.3.1 Coil Physical Data Calculations. Procedure for calculation of coil physical data and fin efficiency upon which both analysis of Laboratory Tests and preparation of ratings are based, is detailed in AHRI OM-410 Addendum Form 410-1 and is based on equations listed under 4.1.

Table 3. Metal Thermal Conductivities		
Material	Temperature	Thermal Conductivity, k Btu·ft/(h·ft ² ·°F) [10 ³ W·mm/(m ² ·°C)]
	°F [°C]	
Aluminum Alloy 1100 Temper O	77 [25]	128.3 [221.7]
Aluminum Alloy 3003 Temper O	77 [25]	111.7 [193.0]
Aluminum Alloy 3003 Temper H18	77 [25]	89.2 [154.1]
Copper (C11000)	68 [20]	226.0 [390.5]
Copper (C12200)	68 [20]	196.0 [338.7]
Red Brass (85-15%, C23000)	68 [20]	92.0 [159.0]
Cupronickel (90-10%, C70600)	68 [20]	26.0 [44.9]
Cupronickel (70-30%, C71500)	68 [20]	17.0 [29.4]
Admiralty (C44300, C44400, C44500)	68 [20]	64.0 [110.6]
Steel-Carbon (SAE 1020)	212 [100]	30.0 [51.8]
Stainless Steel 304, 304L, 316, 316L	212 [100]	9.4 [16.2]
Stainless Steel 410 and 420	212 [100]	14.4 [24.9]
Stainless Steel 347 and 321	212 [100]	9.3 [16.1]
See References A1.9 and A1.11.		

6.3.2 Calculation of Metal Thermal Resistance for Fin and Tube Assembly. Calculation procedure for establishing the metal thermal resistance, R_m , is detailed in Form 410-1, and is based on equations listed under 6.2.1. No experimental data are required for these calculations. Metal thermal conductivities for use in Form 410-1 are contained in Table 3.

R_m consists of two resistances in series: (a) the variable thermal resistance, R_f , of the external fins based on total surface effectiveness for either dry or wet surface, and (b) the constant thermal resistance, R_t , of the prime tube wall. Depending upon tube design, R_t may or may not be negligible.

An illustrative plot of $(R_{oD} + R_{mD})$ vs. R_{oD} is shown in Figure 1 and is for dry surface application only. This plot is used for analysis of either Laboratory Test results or ratings of sensible heat coils.

An illustrative plot of R_m vs. f_{oD} for dry surface coils or R_m vs. f_{oW} for wet surface coils is shown in Figure 2.

For wet surface, the term, m''/c_p , is determined from Figure 8. The data illustrated in Figure 2 are used to determine R_m in either the analysis of Laboratory Test results or for ratings of all coil types.

All calculations of the fin thermal resistance, R_f , shall be based on the fin efficiencies, ϕ , as developed in Reference A1.10. This data by Gardner for annular shaped fins with both constant fin thickness and constant fin cross-sectional area designs are shown, respectively, in Figure 10 and Figure 11.

For non-circular shaped fins, the fin segmentation method, described in References A1.8 and A1.16, may be used to compute the fin thermal resistance, R_f . The fin efficiency of the individual fin segments shall be based on data by Gardner from Figure 10 or Figure 11.

6.3.3 Air Sensible Heat Steam Coils. Calculation procedure for determining the performance factors for steam coil ratings derived from Laboratory Tests, is detailed in Form 410-2. This analysis is based on the applicable heat transfer equations under 6.2.2. This procedure also includes parameters, based on experimental results, used to determine coil air-side pressure drop. The steam pressure drop inside tubes is determined by the calculation procedure as detailed in Form 410-3.

From analysis of Laboratory Tests on steam coils as outlined in Forms 410-2 and 410-3, the following plots of experimental data are used for ratings as illustrated in Figure 3:

- a. R vs. V_a
- b. $\frac{\Delta p_{st}}{N_r}$ vs. V_a
- c. $\frac{\Delta p_{rv}}{L_e v_{mg}}$ vs. $\frac{w_v}{N_c}$

A typical thermal diagram for steam coils with fluid temperature designations is shown on the last page of Form 410-2.

6.3.4 Air Sensible Heat Hot and Cold Water Coils. Calculation procedure for determining the performance factors for both air sensible heat hot and cold water coil ratings derived from Laboratory Tests, is detailed in Form 410-2. This analysis is based on the applicable heat transfer equations under 6.2.2. This procedure also includes parameters, based on experimental results, used to determine coil air-side pressure drop. The water pressure drop inside tubes is determined by the calculation procedure as detailed in Form 410-3.

From analysis of Laboratory Tests on air sensible heat hot or cold water coils as outlined in Form 410-2 and 410-3, the following plots of experimental data are used for ratings as illustrated in Figure 4 along with water performance for smooth internal tube coils from Figure 17.

- a. R_{aD} vs. V_a
- b. $(R_{aD} + R_{mD})$ vs. V_a
- c. $\frac{\Delta p_{st}}{N_r}$ vs. V_a
- d. $\frac{h_{Lt}}{L_e F_t}$ vs. V_w

For tube designs other than smooth internal tube walls, water performance from 5.4.3.2 shall be used.

The factors, F_t and F_h , shown in Figure 7, are used to correct the tube circuit and header pressure drop, respectively, for other average water temperatures at constant mass flow.

Typical thermal counterflow diagrams for hot and cold water coils with fluid temperature designations are shown on the last page of Form 410-2.

6.3.5 Cold Water Cooling and Dehumidifying Coils. Calculation procedure for determining the performance factors for cold water cooling and dehumidifying coil ratings, derived from Laboratory Tests, is detailed in Form 410-2. This analysis is based on the applicable heat transfer equations under 6.2.3. Separate procedures are included for conditions where the coil surface is either completely wet or completely dry. A parameter, based on test results, is included to determine wet surface coil air-side pressure drop. Besides wet surface air-side pressure drop, the basic purpose of this series of tests is to determine values of the wet surface air film thermal resistance, R_{aW} , over the rated range of coil standard air face velocity, V_a , and to establish whether R_{aW} differs from the corresponding dry surface value, R_{aD} , at a given standard air face velocity. R_{aW} and R_{aD} at a given value of V_a may or may not be the same depending upon the particular coil surface design and arrangement.

From analysis of Laboratory Tests on cold water cooling and dehumidifying coils as outlined in Forms 410-2 and 410-3, the following plots of experimental data are used for ratings as illustrated in Figure 5 along with water performance for smooth tube coils from Figure 17:

- a. R_{aW} vs. V_a
- b. $\frac{\Delta p_{sw}}{N_r}$ vs. V_a

Also shown in Figure 5 are the following data from Figure 4 (see 6.3.4) based on dry surface tests which are also applicable for partially wet surface operation:

- c. R_{aD} vs. V_a
- d. $\frac{\Delta p_{st}}{N_r}$ vs. V_a

e. $\frac{h_{Lt}}{L_e F_t}$ vs. V_w

For tube designs other than smooth internal tube walls, water performance from 5.4.3.2 shall be used.

The factors, F_t and F_h , shown in Figure 7, are used to correct the tube circuit and header pressure drop, respectively, for other average water temperatures at constant mass flow.

A typical thermal counterflow diagram for cold water cooling and dehumidifying coils is shown on the last page of Form 410-6. This diagram illustrates the condition where a part of the coil surface is operating dry. Air enthalpies, the temperature conditions of fluids and surface, and the dry-wet boundary conditions are illustrated as used in the analysis given in Forms 410-2 and 410-3.

6.3.6 Volatile Refrigerant Cooling and Dehumidifying Coils. Calculation procedure for determining the performance factors for volatile refrigerant cooling and dehumidifying coil ratings, derived from Laboratory Tests, is detailed in Form 410-4. This analysis is based on the applicable heat transfer equations under 6.2.3. Separate procedures are included for conditions where the coil surface is either completely wet or completely dry. The basic purpose of this series of tests is to determine the refrigerant evaporating film heat transfer coefficients, f_r , and the refrigerant pressure drops, Δp_{rc} , through the coil tube circuit.

From analysis of Laboratory Tests on volatile refrigerant cooling and dehumidifying coils as outlined in Forms 410-4, the following plots of experimental data are used for ratings as illustrated in Figure 6.

a. R_r vs. $\frac{q_t}{N_c}$

b. $\frac{\Delta p_{rc}}{L_e v_{rc2g}}$ vs. $\frac{w_r}{N_c}$

Also shown in Figure 6 are the following data from Figure 5 determined from water coil tests and previous calculations.

c. $\frac{\Delta p_{st}}{N_r}$ vs. V_a

d. $\frac{\Delta p_{sw}}{N_r}$ vs. V_a

e. R_{aD} vs. V_a

f. R_{aW} vs. V_a

A typical thermal counterflow diagram for volatile refrigerant cooling and dehumidifying coils is shown on the last page of Form 410-6. This diagram illustrates the condition where a part of the coil surface is operating dry. Air

enthalpies, the temperature conditions of fluids and surface, and the dry-wet boundary conditions are illustrated as used in the analysis given in Form 410-4.

6.3.7 Aqueous Ethylene Glycol or Aqueous Propylene Glycol Solution Coils. Calculation procedure for determining the performance factors for aqueous ethylene glycol or aqueous propylene glycol solution coil ratings, derived from Laboratory Tests, is detailed in Form 410-7. This analysis is based on the applicable heat transfer equations of Figure 16. The procedure is for conditions where the coil surface is completely dry. The basic purpose of this series of tests is to determine the aqueous ethylene glycol or aqueous propylene glycol solutions tube-side heat transfer performance (j and f_g) and friction factor, f' .

From analysis of Laboratory Tests on aqueous ethylene glycol or aqueous propylene glycol solution coils as outlined in Forms 410-7, the following plots of experimental data are used for ratings as illustrated in Figure 16.

a. j vs. Re

b. f' vs. Re

Also used for aqueous ethylene glycol and aqueous propylene glycol solutions coil ratings are the following data from Figure 5 determined from water coil tests and previous calculations.

c. R_{aD} vs. V_a

d. R_{aW} vs. V_a

e. $(R_{aD} + R_{mD})$ vs. V_a

f. $\frac{\Delta p_{st}}{N_r}$ vs. V_a

g. $\frac{\Delta p_{sw}}{N_r}$ vs. V_a

A typical thermal counterflow diagram for aqueous ethylene glycol or aqueous propylene glycol solution coils is shown on the last page of Form 410-9. This diagram illustrates the condition where a part of the coil surface is operating dry. Air enthalpies, the temperature conditions of fluids and surface, and the dry-wet boundary conditions are illustrated as used in the analysis given in Forms 410-7.

6.4 Standard Ratings.

6.4.1 Tolerances. Standard Ratings shall be such that any coil selected at random will have a total capacity, when tested, not less than 95% of its published total capacity. Published values of air-side pressure drop, under test, shall not be exceeded by more than 10%, or 0.05 in H₂O [5 Pa], whichever is greater. ~~Published values of air side pressure drop, under test, shall not be exceeded by more than 10% or 0.02 in H₂O [5 Pa], whichever is greater.~~ Published values of tube-side pressure drop, under test, shall not be exceeded by more than 10%, or 1.0 ft of fluid [0.3048 m of fluid], whichever is greater.

6.4.2 Computations. Computations for Standard Ratings shall be based on heat transfer coefficients and coil characteristics obtained by Laboratory Tests.

In this standard, expressions for logarithmic mean effective differences, Δt_m and Δh_m , are only illustrated for the case of thermal counterflow between the air- and tube-side fluids, as defined under 6.2.2 and 6.2.3.2. It shall be the responsibility of the manufacturer to include appropriate allowances to these logarithmic mean effective differences for those coil designs where the tube circuiting arrangement causes deviations from the thermal counterflow relationships described in this standard.

In publishing Standard Ratings, it shall be the responsibility of the manufacturer to include appropriate allowances for the effects of tube pressure drop, condensate accumulation, etc., on coil capacity.

6.4.3 *Air Sensible Heat Steam Coils.* A suggested method for rating air sensible heat steam coils is shown on Form 410-5.

Standard Ratings for determining either number of rows, N_r , requirements or sensible heat capacity, q_s , for specific job conditions may be obtained by use of the following data:

- a. Performance factors as illustrated in Figure 3
- b. Applicable heat transfer equations in 6.2.2
- c. Manufacturer established steam pressure drop parameters (headers, nozzles, tube entrance and exit, and equivalent length of coil circuit per return bend)

6.4.4 *Air Sensible Heat Hot and Cold Water Coils.* This method of rating the sensible cooling coils is for application where the air sensible heat ratio, $q_s/q_t \geq 0.95$. For conditions where, $q_s/q_t < 0.95$, use the wet surface, total heat method described in 6.4.5. A suggested method for rating air sensible heat hot and cold water coils is shown on Form 410-5.

Standard Ratings for determining either number of rows, N_r , requirements or sensible heat capacity, q_s , for specific job conditions may be obtained by use of the following data:

- a. Performance factors as illustrated in Figure 4
- b. Water performance for smooth internal tube wall coils from Figure 17. For tube designs other than smooth internal tube walls, water performance from 5.4.3.2 shall be used.
- c. Applicable heat transfer equations in 6.2.2
- d. F_t and F_h in Figure 7
- e. Manufacturer established water pressure drop parameters (headers, nozzles, tube entrance and exit, and equivalent length of coil circuit per return bend)

6.4.5 *Cold Water Cooling and Dehumidifying Coils.* This method of rating is for application where the air sensible heat ratio, $q_s/q_t < 0.95$. For conditions where $q_s/q_t \geq 0.95$, use the dry surface, sensible heat method described in 6.4.4. A suggested method for rating cold water cooling and dehumidifying coils is shown on Form 410-6.

Standard Ratings for determining either total external surface area, A_o , requirements or total heat capacity, q_t , for specific job conditions may be obtained by use of the following data:

- a. Performance factors as illustrated in Figure 5
- b. Water performance for smooth internal tube wall coils from Figure 17. For tube designs other than smooth internal tube walls, water performance from 5.4.3.2 shall be used.
- c. Applicable heat transfer equations in 6.2.2 and 6.2.3
- d. m''/c_p in Figure 8 for wet surface
- e. R_m for dry and wet surface as illustrated in Figure 2
- f. F_t and F_h in Figure 7

- g. Universal surface temperature chart in Figure 9
- h. Manufacturer established water pressure drop parameters (headers, nozzles, tube entrance and exit, and equivalent length of coil circuit per return bend)

6.4.6 *Volatile Refrigerant Cooling and Dehumidifying Coils.* This method of rating is for application where the air sensible heat ratio, $q_s/q_t < 0.95$.

For conditions where $q_s/q_t \geq 0.95$, use the dry surface, sensible heat method described in 6.4.4 except for the following change of data

- a. Use the plot for R_r as illustrated in Figure 6 instead of Figure 17.
- b. Use the plot for $\Delta p_r / (L_e v_{rc2g})$ as illustrated in Figure 6 instead of the plot for $h_{L,t} / (L_e F_t)$ in Figure 4.
- c. Use manufacturer established refrigerant instead of water pressure drop parameters (headers, nozzles, tube entrance and exit, and equivalent length of coil circuit per return bend)

Standard Ratings for determining either total external surface area, A_o , requirements or total heat capacity, q_o , for specific job conditions may be obtained by use of the following data:

- a. Performance factors as illustrated in Figure 6
- b. Applicable heat transfer equations in 6.2.2 and 6.2.3
- c. m''/c_p in Figure 8 for wet surface
- d. R_m for dry and wet surface as illustrated in Figure 2
- e. Universal surface temperature chart in Figure 9
- f. Manufacturer established refrigerant pressure drop parameters (headers, nozzles, tube entrance and exit, and equivalent length of coil circuit per return bend)

6.4.7 *Aqueous Ethylene Glycol and Aqueous Propylene Glycol Solution Coils.* The method of rating aqueous ethylene glycol and aqueous propylene glycol solution coils is identical to that described in 6.4.4 and 6.4.5 for water coils except the j and f factors in Figure 16 must be used to determine the tube-side performance data. Suggested methods for rating sensible heat coils and cooling and dehumidifying coils are shown on Forms 410-8 and 410-9, respectively.

Section 7. Minimum Data Requirements for Published Ratings

7.1 *Minimum Data Requirements for Published Ratings.* As a minimum, Published Ratings shall include all Standard Ratings. All claims to ratings within the scope of this standard shall include the statement "Rated in accordance with AHRI Standard 410". All claims to ratings outside the scope of this standard shall include the statement "Outside the scope of AHRI Standard 410". Wherever Application Ratings are published or printed, they shall include a statement of the conditions at which the ratings apply.

Where applicable, the following information, or the means for determining it, based on tests, shall be published or made available through an automated rating/selection computer procedure within the range of rating conditions specified in Table 1.

- a. Manufacturer's name and address
- b. Model, size and/or type
- c. Heating/cooling medium
- d. All applicable input information specified in Table 1
- e. Standard air volumetric flow rate, scfm [std. m³/s]
- f. Air pressure drop through coil at standard air density (dry and wet surface), in H₂O [kPa]

- g. Total cooling capacity (dehumidifying coils only), Btu/h [W]
- h. Sensible heating/cooling capacity, Btu/h [W]
- i. Leaving air dry-bulb temperature, °F [°C] or for heating coils, air dry-bulb temperature rise, °F [°C]
- j. Leaving air wet-bulb temperature, °F [°C]
- k. Standard water, ~~or~~ aqueous ethylene glycol, ~~or~~ aqueous propylene glycol solution volumetric flow rate, sgpm [std. m³/s]
- l. Water, ~~or~~ aqueous ethylene glycol, ~~or~~ aqueous propylene glycol solution fouling factor allowance, h·ft²·°F/Btu [m²·°C/W]
- m. Leaving water, ~~or~~ aqueous ethylene glycol, ~~or~~ aqueous propylene glycol solution temperature or, ~~or~~ aqueous ethylene glycol, ~~or~~ aqueous propylene glycol solution temperature difference, °F [°C]
- n. Water, ~~or~~ aqueous ethylene glycol, ~~or~~ aqueous propylene glycol solution pressure drop through coil (including headers) at average fluid density, ft of fluid [m of fluid]
- o. Subcooled refrigerant liquid temperature entering liquid control device, °F [°C]

The preceding information shall be published or made available at a barometric pressure of 29.92 in Hg [101.3 kPa] and may also be published or made available at other barometric pressures, providing these pressures are clearly identified.

Section 8. Symbols and Units (Dimensionless unless otherwise noted)

8.1 Letter Symbols.

- A - Area, ft² [m²]
 - A_i - Total internal surface area, ft² [m²]
 - A_o - Total external surface area, ft² [m²]
 - A_p - Primary surface area, which consists of the exposed external tube area (if any) plus the external fin collar area, if used, less the area under the fins corresponding to the fin root thickness, ft² [m²]
 - A_s - Secondary surface area (net fin area), ft² [m²]
1. *Flat Plate Fins.* The secondary surface area is the sum of the areas of the fin sheets minus the areas of the tube holes. Any fin collar areas are excluded (see 4.1.3.1).
 2. *Configurated Plate Fins.* The secondary surface area is determined in the same way as for a flat plate except the area dimensions, L_f and L_d, are determined, at the option of the manufacturer, from the blank fin sheet size prior to forming the configuration provided no edge trimming is performed after forming, or from the finished fin size after forming (see 4.1.2).
 3. *Spiral Fins.* The secondary surface area consists of the exposed lateral and outside fin edge areas, calculated on the basis of an annular type fin, which neglects the helical fin pitch. For crimped fins, the lateral area is composed of the actual developed area of the crimped fin portion plus any smooth annular area at the outer extremities of the fin (see 4.1.3.1).
- B - Ratio of total external coil surface area to the total internal surface area, A_o/A_i
 - C - Coil characteristic, lb·°F/Btu [kg·°C/kJ] [as defined in Equations (17), (17a), (17b), (18), (18a) and (18b) in 6.2.3.3]
 - c - Heat transfer exponent (as defined in Equation (25) in 6.2.3.5)
 - c_o - Heat transfer exponent (as defined in Figures 13, 14 and 15)
 - c_p - Specific heat at constant pressure of air-water vapor mixture, 0.240 + 0.444W, Btu/(lb dry air·°F) [1.005 + 1.859W, kJ/(kg dry air·°C)]. To simplify calculation and rating procedures, a constant value of c_p = 0.243 [1.017] may be used for cooling calculations and a constant value of c_p = 0.241 [1.009] may be used for heating calculations.

- c_{pg} - Specific heat at constant pressure of aqueous ethylene glycol or aqueous propylene glycol solutions, Btu/(lb·°F) [kJ/(kg·°C)]
- c_{pw} - Specific heat at constant pressure of water, Btu/(lb·°F) [kJ/(kg·°C)]. To simplify calculation and rating procedures, a constant value of $c_{pw} = 1.000$ [4.187] may be used.
- D - Diameter, in [mm]
- E - Air-side effectiveness (as defined in Figures 13, 14 and 15)
- F_a - Air-side pressure drop correction factor
- F_t - Temperature correction factor for water pressure drop inside smooth tubes at mean temperature, t_{wm} , of operating condition
- F_h - Temperature correction factor for header water pressure drop at mean temperature, t_{wm} , of operating condition
- f - Heat transfer coefficient (air-side is referred to total external area, A_o ; all others are referred to total internal area, A_i), Btu/(h·ft²·°F) [W/(m²·°C)]
- f' - Friction factor for aqueous ethylene glycol and aqueous propylene glycol solution coils
- G - Mass velocity lb/(h·ft²) [kg/(s·m²)]
- H - Coil face height (as illustrated in 4.1.2), in [mm]
- h - Enthalpy, Btu/lb [kJ/kg] (when applied to air, Btu/lb dry air [kJ/kg dry air])
- h_L - head loss at average liquid density, ft of liquid [m of liquid]
- Δh - Enthalpy difference, Btu/lb dry air [kJ/kg dry air]
- j - Colburn heat transfer factor
- k - Material thermal conductivity, Btu·ft/(h·ft²·°F) [W·mm/(m²·°C)] (see Table 3)
- L - Length, in [mm]
- L_e - Total equivalent length of tube circuit, ft [m]
- L_{eb} - Equivalent length of tube circuit per return bend, in [mm]
- M - Air-to-fluid heat capacity ratio (as defined in Figures 13, 14, and 15)
- m'' - Slope of saturated air temperature-enthalpy curve at the coil surface temperature, t_s , Btu/(lb·°F) [kJ/(kg·°C)]
- N - Number of
- P - Absolute pressure (psia or in Hg abs) [kPa abs]
- p - Gage pressure (psi or in Hg or in H₂O) [kPa gage]
- Δp - Difference in pressure (psi or in H₂O) [kPa]
- Pr - Prandtl number
- Q_{aSTD} - Standard air volumetric flow rate (standard air density = 0.075 lb/ft³ [1.2 kg/m³]) which approximates dry air density at 70°F [21.1°C] and 14.696 psia [101.325 kPa abs], scfm [std. m³/s]
- Q_{wSTD} - Standard water volumetric flow rate (standard water density = 62.361 lb/ft³ [998.927 kg/m³]) which approximates water density at 60°F [15.6°C] and 14.7 psia [101.325 kPa abs], sgpm [std. m³/s]
- Q_{gSTD} - Standard aqueous glycol or aqueous propylene glycol solutions volumetric flow rate (standard aqueous glycol solution density = 62.361 lb/ft³ [998.927 kg/m³]) which approximates water density at 60°F [15.6°C] and 14.696 psia [101.325 kPa abs], sgpm [std. m³/s]
- q - Heat transfer capacity, Btu/h [W]
- R - Thermal resistance, referred to total external area, A_o , h·ft²·°F/Btu [m²·°C/W]
- Re - Reynolds Number
- s_{hf} - Continuous plate fin hole spacing across coil face, in [mm]
- s_{hr} - Continuous plate fin hole spacing in direction of air flow, in [mm]
- s_{tf} - Tube spacing across coil face, in [mm]
- s_{tr} - Tube spacing in direction of air flow, in [mm]
- St - Stanton Number
- t - Temperature, °F [°C]
- Δt - Temperature difference, °F [°C]
- U - Overall heat transfer coefficient, referred to the total external surface area, A_o , Btu/(h·ft²·°F) [W/(m²·°C)]
- V_a - Standard air face velocity, std. ft/min [std. m/s]
- V_g - Average aqueous ethylene glycol or aqueous propylene glycol solutions velocity inside tubes at average aqueous ethylene glycol or aqueous propylene glycol solutions density, ft/s [m/s]
- V_w - Standard water velocity inside tubes, std. ft/s [std. m/s]

- v - Specific volume, ft³/lb [m³/kg]
- W - Humidity ratio of air-water vapor mixture, lb water vapor/lb dry air [kg water vapor/kg dry air]
- w - Height of equivalent annular fin, x_e-x_b , in [mm] (when no subscript is used)
 - Mass flow rate (when used with subscript), for air lb dry air/min [kg dry air/s], for water, refrigerant and aqueous ethylene glycol or aqueous propylene glycol solutions- lb/h [kg/s]
- x - Radius, in [mm]
- x_g - Composition by mass of aqueous ethylene glycol or aqueous propylene glycol solutions, %
- x_r - Mass fraction of volatile refrigerant vapor
- Y - Fin thickness, in [mm]
- y - Ratio of fluid temperature rise to air enthalpy drop, lb·°F/Btu [kg·°C/kJ] (see Equations (20), (20a) and (20b))
- η - Total external surface effectiveness
- ϕ - Fin efficiency
- ρ - Density, lb/ft³ [kg/m³]
- μ - Dynamic viscosity at mean bulk temperature, lb/(ft·h) [mPa·s]
- μ_{tw} - Dynamic viscosity at mean tube wall temperature, lb/(ft·h) [mPa·s]

8.2 Subscripts.

8.2.1 Numerical subscripts:

- 0 - Refers to conditions entering liquid control device
- 1 - Refers to conditions entering coil
- 2 - Refers to conditions leaving coil

8.2.2 Letter subscripts are used to further identify the letter symbols. They are:

- a - Air-side
- B - Conditions at dry-wet boundary
- b - Fin root (when used with symbol, x)
 - Return bends (when used with symbol, N)
- c - Assumed value (when used with symbol, A)
 - Plate fin external collar (when used with symbol, L)
 - Tube circuits (when used with symbol, N)
- D - Dry surface
- d - Plate fin depth in direction of air flow (when used with symbol, L)
 - At outer edge of spiral fin at D_f (when used with symbol, Y)
- db - Dry-bulb
- dp - Dew point (when used with symbol, t)
 - Saturated air at t_{1dp} (when used with symbol, h)
- e - Outside edge of spiral fin (when used with symbol, Y)
 - Outside, or equivalent annular area of non-circular fin or of annular or spiral fin (when used with symbol, x)
- f - Across coil face (when used with symbol, s)
 - Coil face (when used with symbol, A)
 - Outside diameter of spiral fin (when used with symbol, D)
 - Fins in net finned tube length (when used with symbol, N)
 - Plate fin length perpendicular to direction of tubes exposed to the air flow (when used with symbol, L)
 - Plate fins of constant thickness (when used with symbol, Y)
 - Saturated liquid (when used with symbols, h_r , t_c , t_r , and t_v)
- ffa - Fouling factor allowance for water, and aqueous ethylene glycol or aqueous propylene glycol solutions coil ratings. See Reference A1.2 for typical values.
- g - Aqueous ethylene glycol or aqueous propylene glycol solutions

- Saturated vapor (when used with symbols h_r , t_r , t_v , v_r , and v_v)
- h - Holes in plate fin
- i - Inside tube
- ih - intermediate headers
- m - Logarithmic mean (when used with Δh or Δt)
 - Mean or average (may be combined with other subscripts)
 - Metal (when used with symbol, R)
- n - Crimped spiral fin neutral diameter (when used with symbol, D)
 - Crimped spiral fin thickness at neutral diameter (when used with symbol, Y)
- o - Outside tube (when used with symbol, D)
- p - Tube passes per tube circuit
- r - Coil rows in direction of air flow (when used with symbols, N)
 - Fin root for spiral fins with constant metal area for heat flow (when used with symbol, Y)
 - Refrigerant (all other symbols)
- rc - Volatile refrigerant coil circuit
- rh - Volatile refrigerant coil suction header
- s - Coil surface (when used with symbol, t)
 - Saturated air at coil surface temperature, t_s , (when used with symbol, h)
 - Sensible heat (when used with symbol, q)
 - Straight tube (when used with symbol, L)
 - Static (when used with symbol, P)
- \square - Effective coil surface (when used with symbol, t)
 - Saturated air at effective coil surface temperature, t_{\square} (when used with symbol, h)
- st - Isothermal dry surface air-side, at standard air density
- sw - Wet surface air-side, at standard air density
- t - Net finned tube (when used with symbol, L)
 - Total (when used with symbol, q)
 - Tube (when used with symbols h_L , k , R , N and s)
- tw - Tube wall
- v - Steam
- W - Wet surface
- w - Water
- wb - Wet-bulb
- x - Cross section

Where no letter subscript follows c_p , h or t these symbols designate air-water vapor mixture properties.

8.3 Superscripts.

8.3.1 Numerical superscripts denote the power to which a number or symbol is raised.

Section 9. Reference Properties and Conversion Factors

9.1 *Reference Properties.* The thermodynamic properties of water and steam shall be obtained from References A1.13 or A1.14. All other properties shall be obtained from the *ASHRAE Handbook - Fundamentals*.

9.2 *Metric Conversion Factors.* For conversion factors from I-P to SI units of measure, see Table 1 of ANSI/ASHRAE Standard 33 and Table 4 in this standard. **(Note: Equations in [] are in SI Units)**

Section 10. Marking and Nameplate Data

10.1 *Marking and Nameplate Data.* As a minimum, nameplate shall display the manufacturer's name and identify designation, such as model or type.

Section 11. Conformance Conditions

11.1 *Conformance.* While conformance with this standard is voluntary, conformance shall not be claimed or implied for products or equipment within its *Purpose* (Section 1) and *Scope* (Section 2) unless such claims meet all of the requirements of the standard

Table 4. Conversion Factors				
Item	I-P	SI	Conversion Unit Name	Conversion Factor I-P x Factor = SI
Dynamic Viscosity	lb/(h·ft)	mPa·s	millipascal second	0.41338
Heat Transfer Capacity	Btu/h	kW	kilowatt	0.00029307
Heat Transfer Coefficient	Btu/(h·ft ² ·°F)	W/(m ² ·°C)	watt per square meter degree Celsius	5.6783
Mass Flow Rate	lb/h	kg/s	kilogram per second	0.000126
Mass Velocity	lb/(h·ft ²)	kg/(m ² ·s)	kilogram per square meter second	0.0013562
Pressure Drop Parameter	lb ² /(in ² ·ft ⁴)	kPa·kg/m ⁴	kilopascal kilogram per meter ⁴	362.35
Thermal Conductivity	Btu·ft/(h·ft ² ·°F)	W·mm/(m ² ·°C)	watt millimeter per square meter degree Celsius	1730.7
Thermal Resistance	h·ft ² ·°F/Btu	m ² ·°C/W	square meter degree Celsius per watt	0.17611

$R_{AD} + R_{mD} = R_{AD} / \eta + R_r = \text{Combined Air Film and Metal Thermal Resistance for Dry Surface, } h \cdot \text{ft}^2 \cdot \text{F} / \text{Btu}$

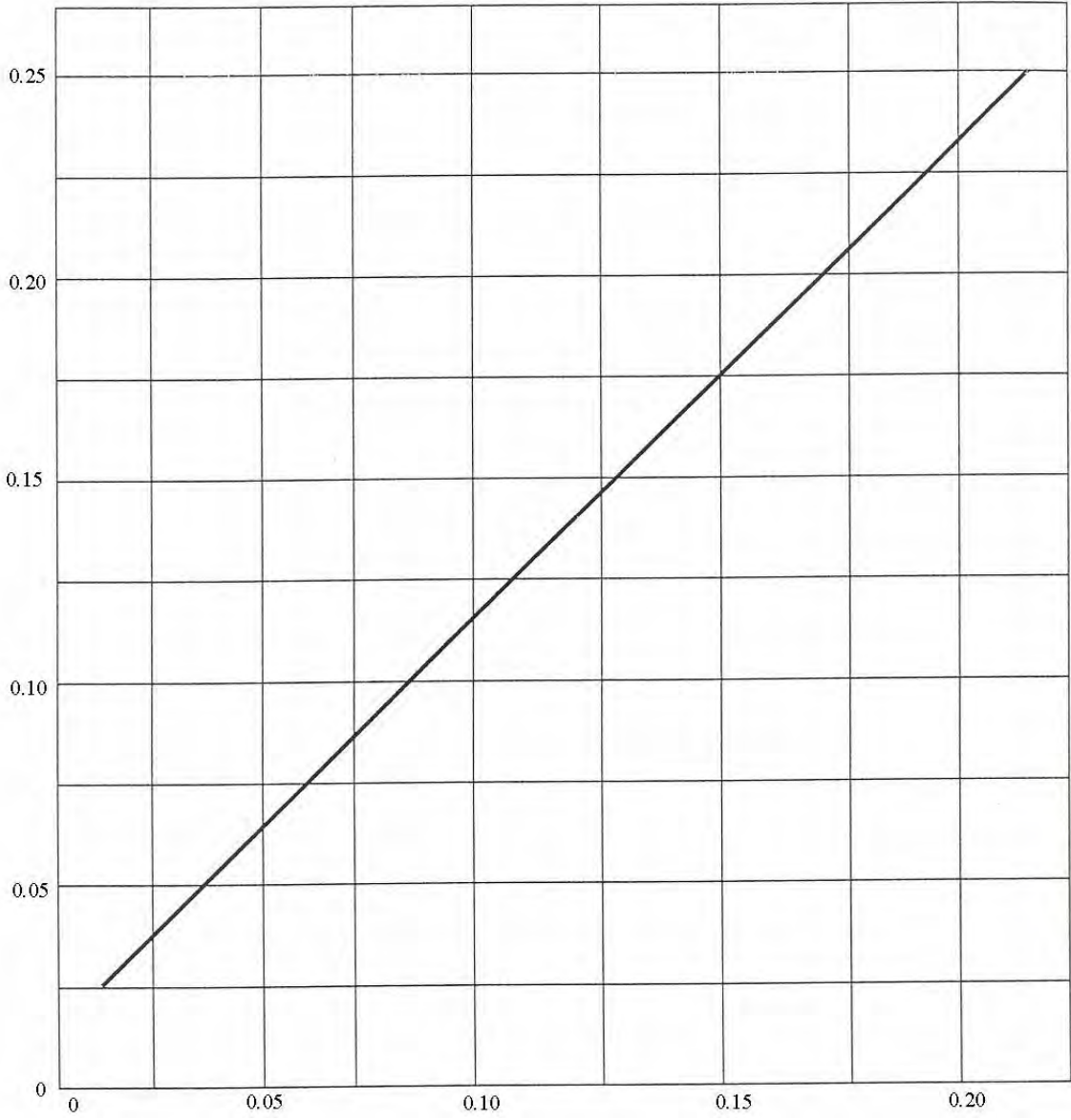

R_{AD} = Air Film Thermal Resistance for Dry Surface,

$h \cdot \text{ft}^2 \cdot \text{F} / \text{Btu}$

Figure 1.

Combined Air Film and Metal Thermal Resistance for Dry Surface

vs.

Air Film Thermal Resistance for Dry Surface

Illustrating performance factors as determined from laboratory tests

Dry Surface Area: $f_a = f_{aD} = 1 / R_{aD}$

For Wet Surface Area: $f_a = f_{aW} = \left(\frac{1}{R_{aW}} \right) \left(\frac{m''}{c_p} \right)$

Note: Determine $\left(\frac{m''}{c_p} \right)$ from Figure 8

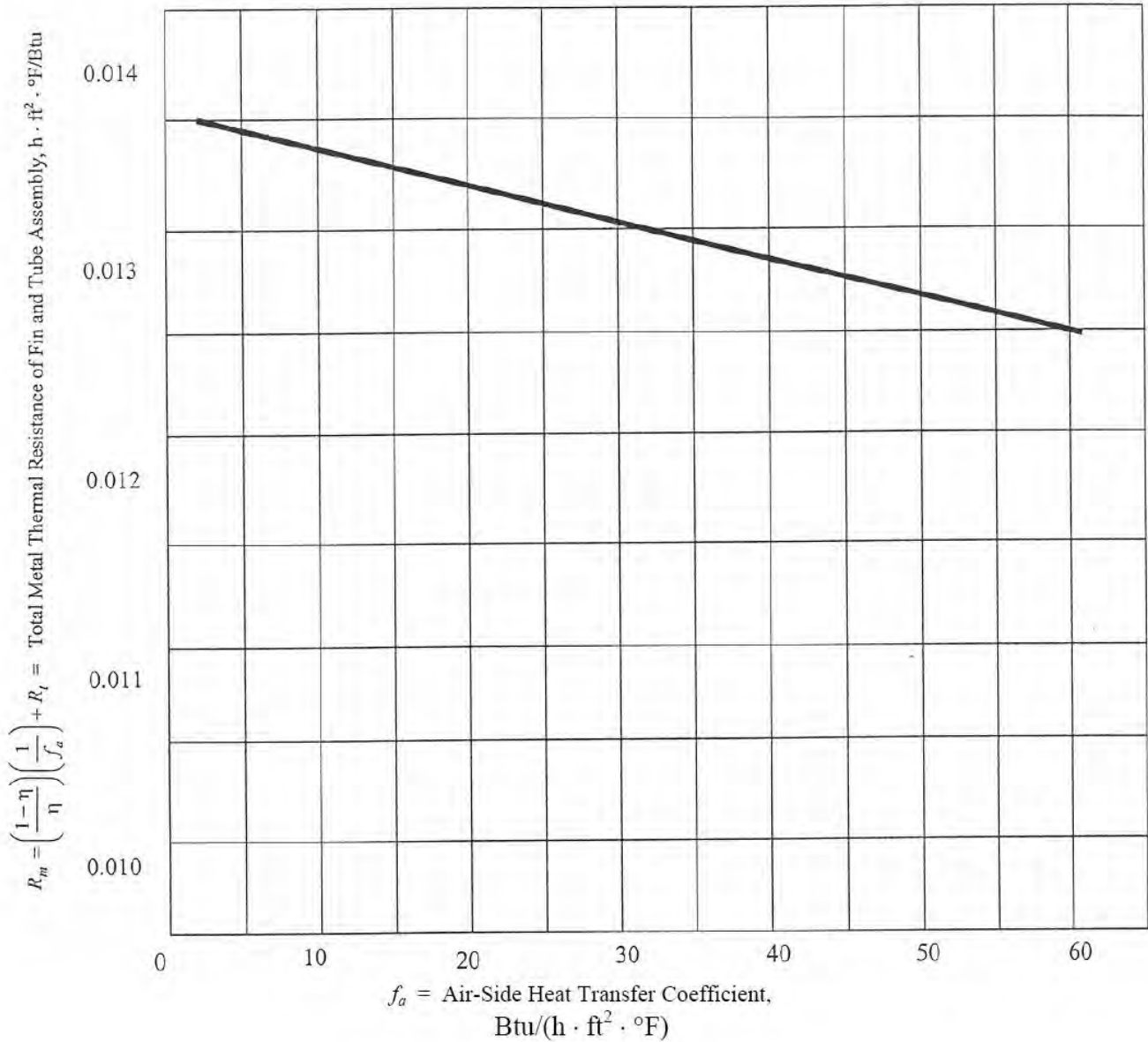

Figure 2. Total Metal Thermal Resistance of Fin and Tube Assembly Based on Total Surface Effectiveness
 Illustrating performance factors as determined from laboratory tests

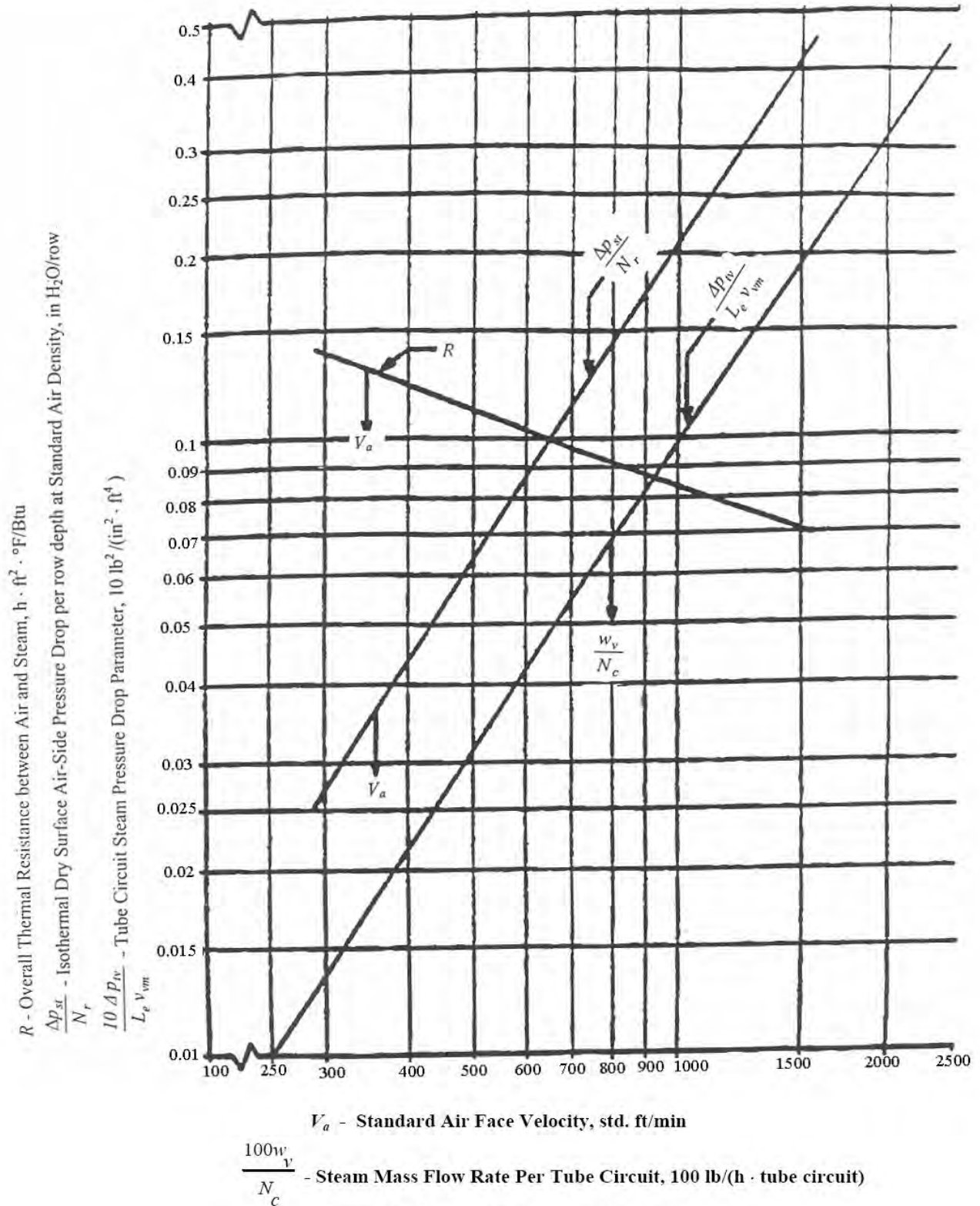

Figure 3. Rating Data for Steam Coils
 Illustrating performance factors as determined from laboratory tests

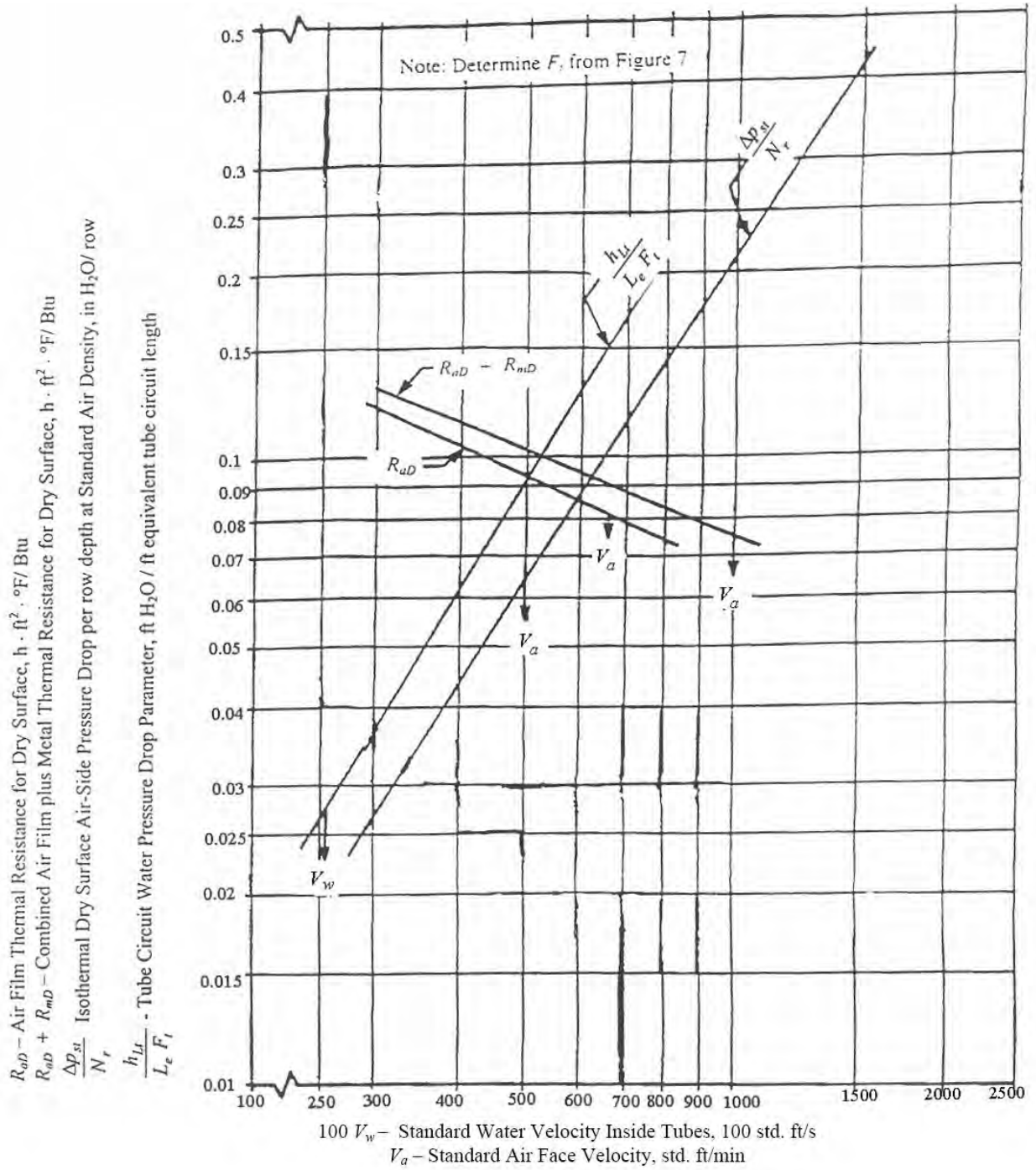

Figure 4. Rating Data for Hot or Cold Water Sensible Heat Coils
 Illustrating performance factors as determined from laboratory tests

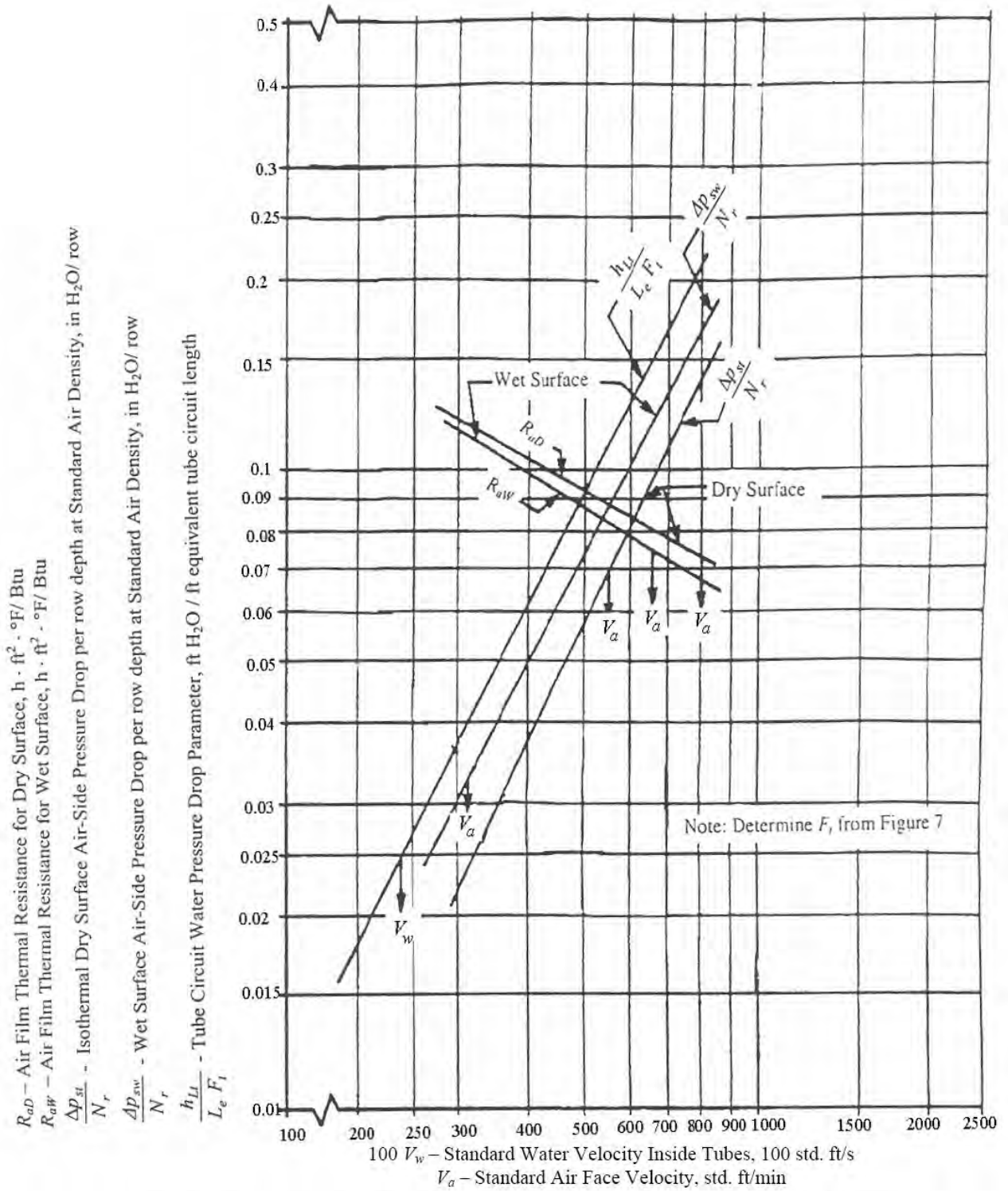
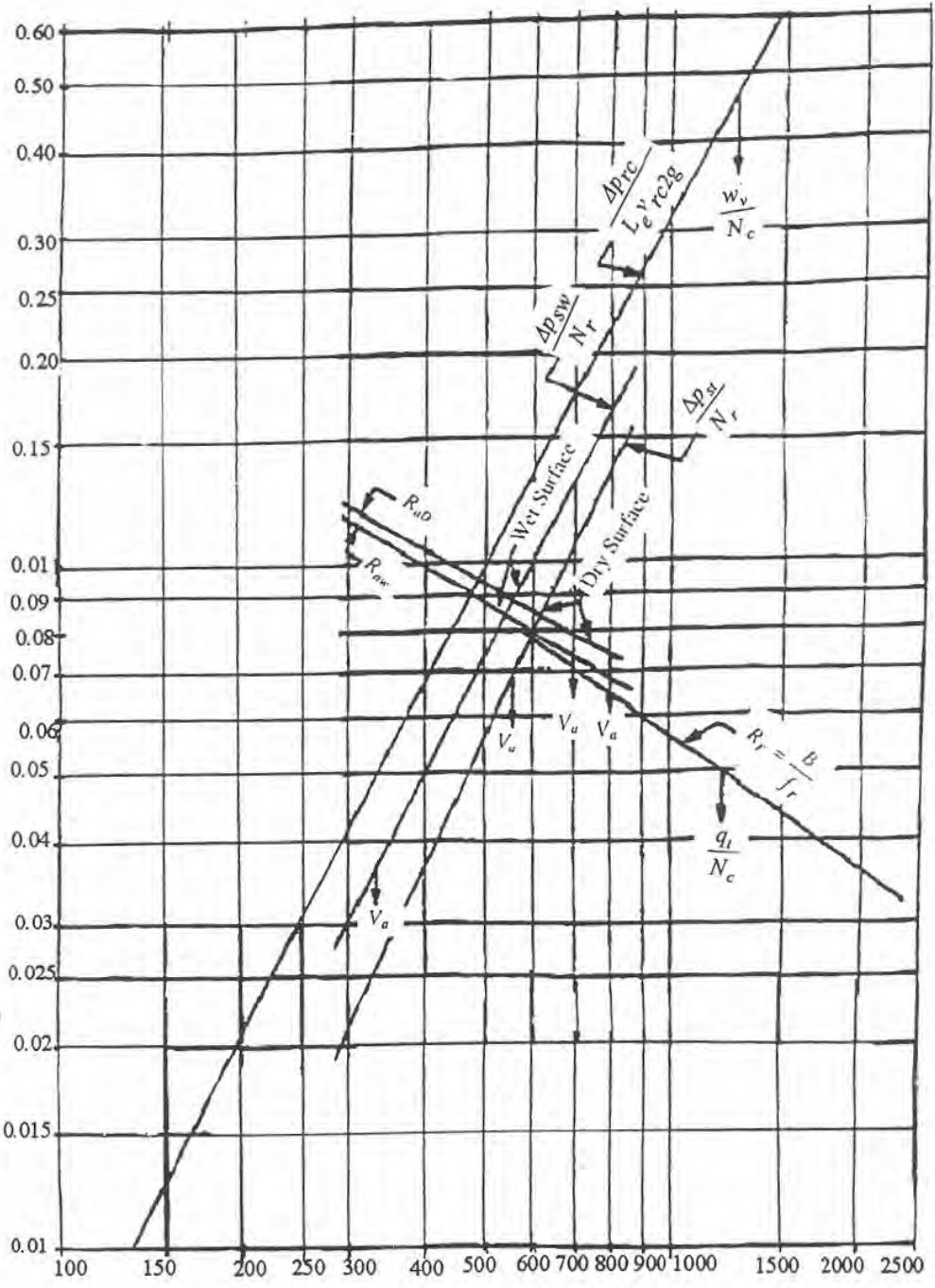

Figure 5. Rating Data for Cold Water Cooling and Dehumidifying Coils
 Illustrating performance factors as determined from laboratory tests.

R_{ad} - Air Film Thermal Resistance for Dry Surface, $h \cdot ft^2 \cdot ^\circ F/Btu$
 R_{aw} - Air Film Thermal Resistance for Wet Surface, $h \cdot ft^2 \cdot ^\circ F/Btu$
 $\frac{\Delta p_{sl}}{N_r}$ - Isothermal Dry Surface Air-Side Pressure Drop per row depth at Standard Air Density, in H_2O/row
 $\frac{\Delta p_{sw}}{N_r}$ - Wet Surface Air-Side Pressure Drop per row depth at Standard Air Density, in H_2O/row
 R_r - Refrigerant Film Thermal Resistance, $h \cdot ft^2 \cdot ^\circ F/Btu$
 $\frac{\Delta p_{rc}}{L_e v_{rc} 2g}$ - Tube Circuit Refrigerant Pressure Drop Parameter, $lb^2/(in^2 \cdot ft^4)$



$\frac{10^{-1} q_t}{N_c}$ - Refrigerant Loading Rate per Tube Circuit, $10^{-1} Btu / (h \cdot tube\ circuit)$
 $\frac{w_r}{N_c}$ - Refrigerant Mass Flow Rate per Tube Circuit, $lb / (h \cdot tube\ circuit)$
 V_a - Standard Air Face Velocity, std. ft/min

Figure 6. Rating Data for Volatile Refrigerant Cooling and Dehumidifying Coils
 Illustrating performance factors as determined from laboratory tests

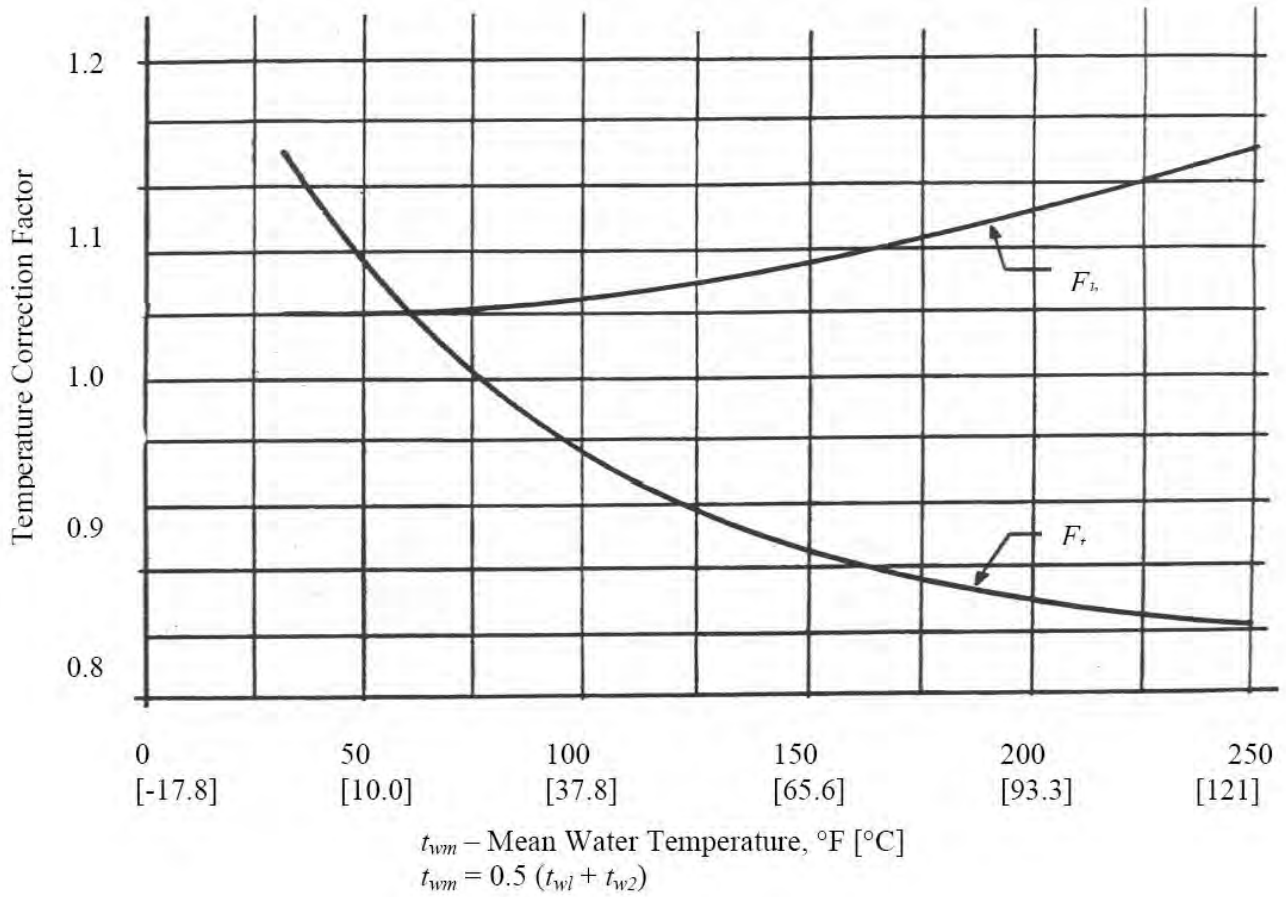

Figure 7. Temperature Correction Factor for Water Pressure Drop

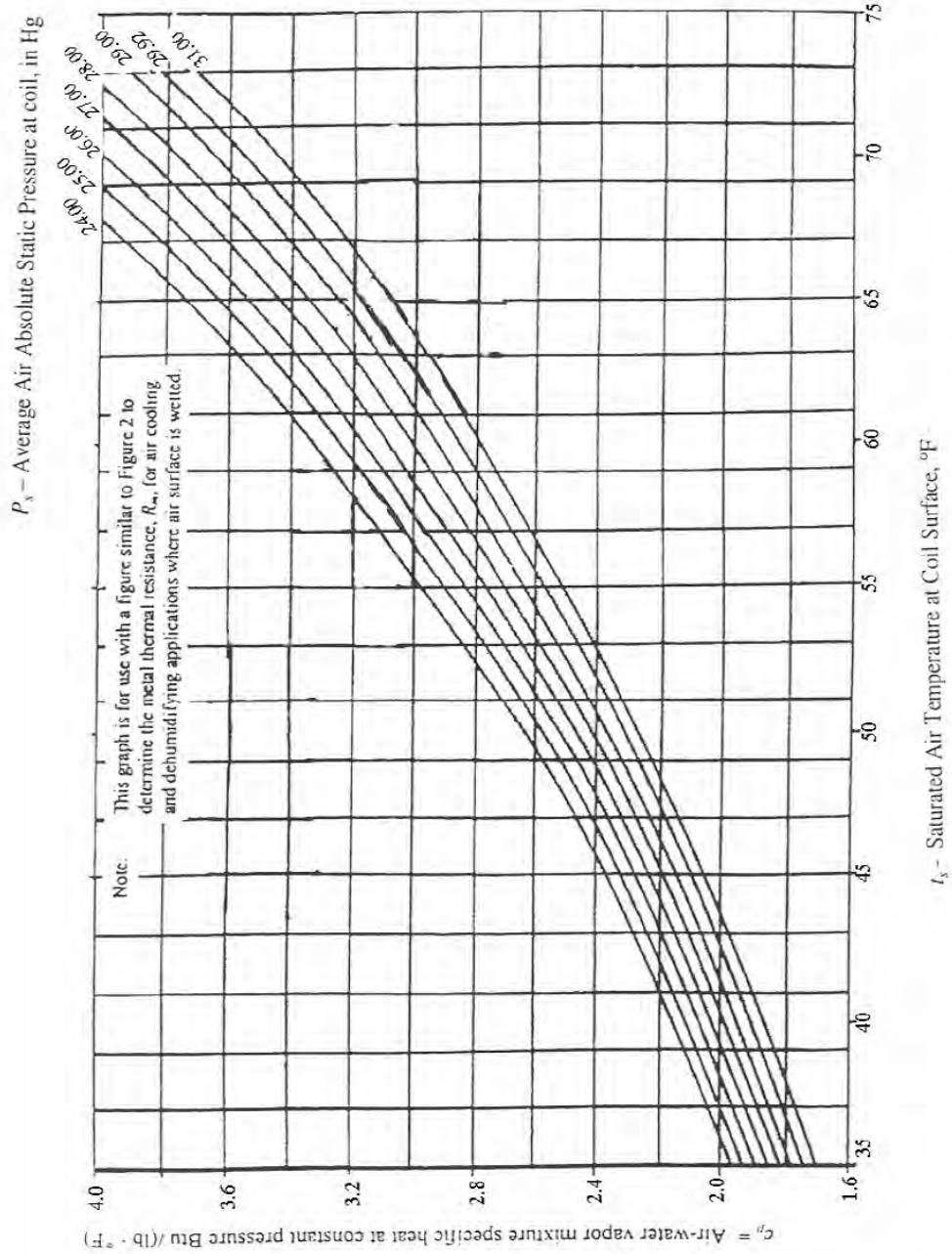

Figure 8. Air-Side Heat Transfer Coefficient Multiplier for Wet Surface

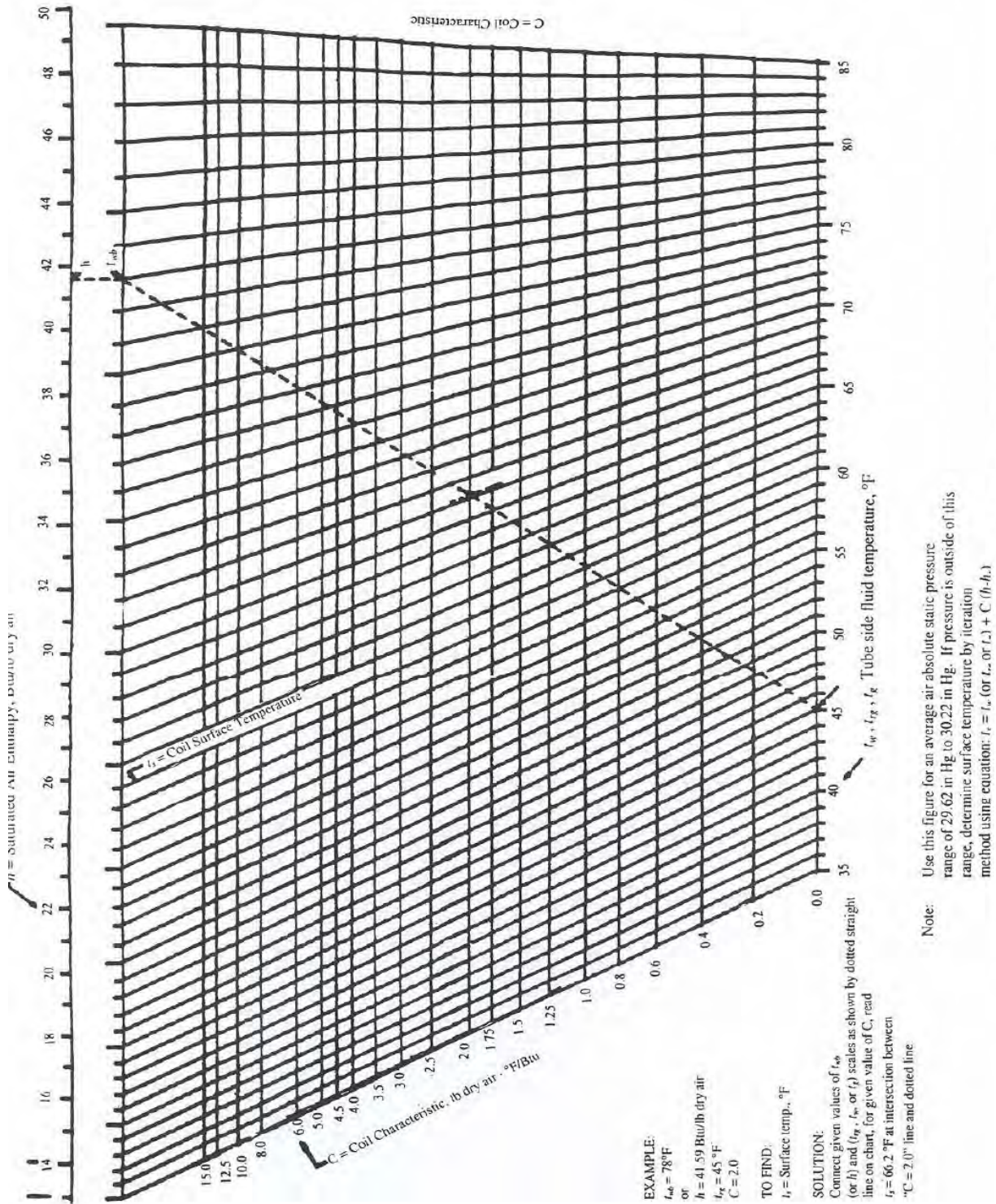

Figure 9. Surface Temperature Chart for Air Cooling and Dehumidifying Coil Application

Nomenclature:

- ϕ - Fin efficiency
- x_b - Fin root radius, in [mm]
- x_e - Fin tip radius, in [mm]
- w - Fin height = $x_e - x_b$, in [mm]
- Y_f - Fin thickness, in [mm]
- f_a - Film coefficient,
Btu/(h · ft² · °F) [W/(m² · °C)]
- k_f - Fin material thermal conductivity
Btu · ft / (h · ft² · °F) [W · mm / (m² · °C)]
- η - Surface effectiveness = $\frac{\phi A_s + A_p}{A_o}$
- A_o - Total external surface area, ft² [m²]
- A_p - Primary surface area, ft² [m²]
- A_s - Secondary surface area, ft² [m²]
- $f_a \eta$ - Effective film coefficient,
Btu/(h · ft² · °F) [W/(m² · °C)]

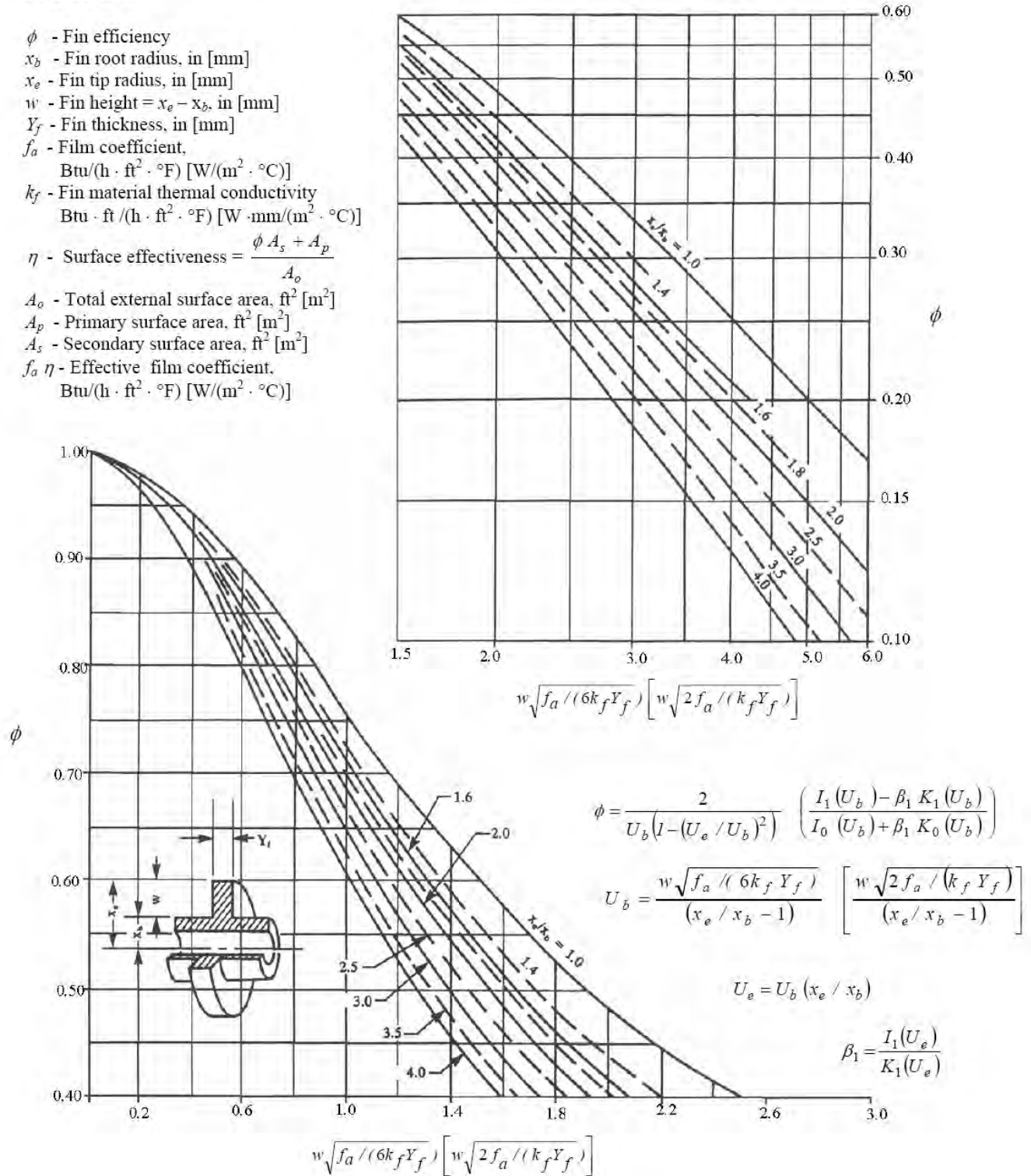

Figure 10. Efficiency of Annular Fins of Constant Thickness

Nomenclature:

- ϕ - Fin efficiency
- x_b - Fin root radius, in [mm]
- x_e - Fin tip radius, in [mm]
- w - Fin height = $x_e - x_b$, in [mm]
- Y_r - Fin thickness at root, in [mm]
- f_a - Film coefficient,
Btu / (h · ft² · °F) [W/(m² · °C)]
- k_f - Fin material thermal conductivity,
Btu · ft / (h · ft² · °F) [W · mm / (m² · °C)]

- η - Surface effectiveness = $\frac{\phi A_s + A_p}{A_o}$
- A_o - Total external surface area, ft² [m²]
- A_p - Primary surface area, ft² [m²]
- A_s - Secondary surface area, ft² [m²]
- $f_a \eta$ - Effective film coefficient,

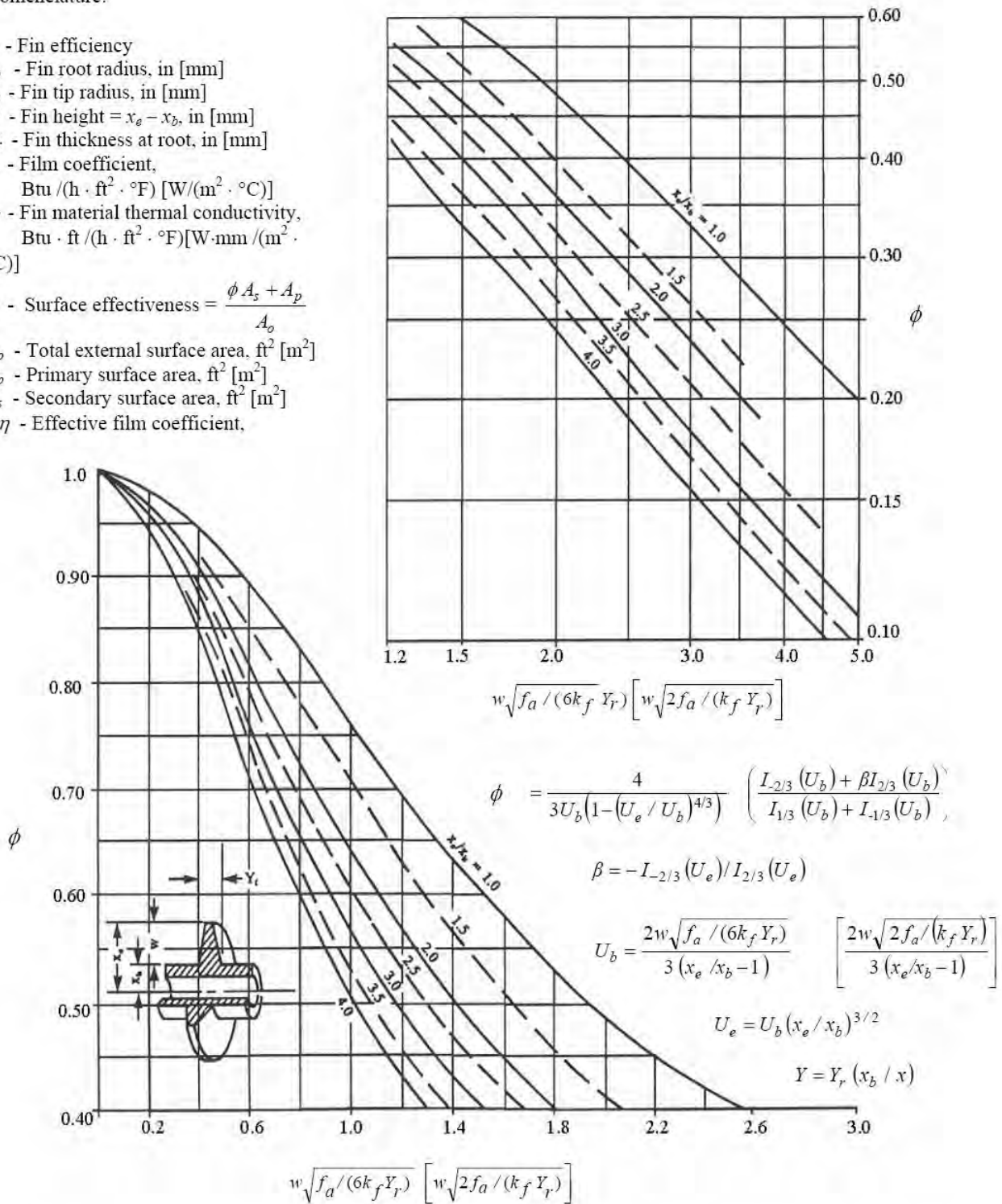

Figure 11. Efficiency of Annular Fins of Constant Area for Heat Flow and Spiral Fins

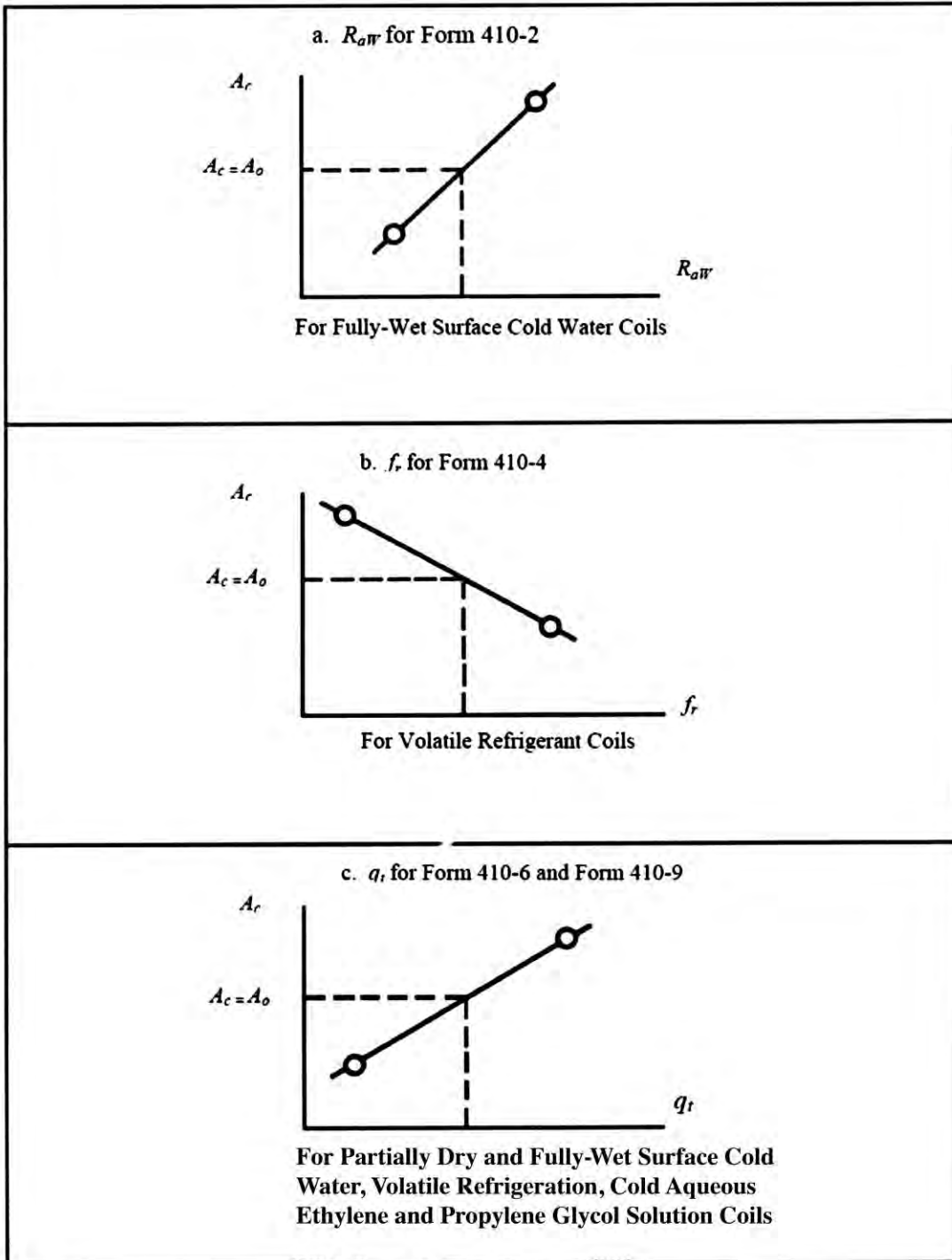
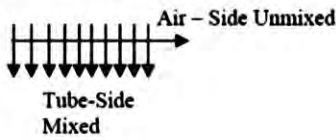

Figure 12. Determination of R_{aW} , f_r and q_t

When $M > 0$: $E = \frac{1 - e^{-M} (1 - e^{-c_o})}{M}$

When $M = 0$: $E = 1 - e^{-c_o}$
 $(t_{w1} - t_{1db}), (t_{g1} - t_{1db}),$ or $(t_{vg} - t_{1db}) =$ Initial Air-to-Fluid Temperature Difference, °F [°C]

Δt_w - Water Temperature Difference, °F [°C]
 Δt_g - Aqueous Ethylene or Propylene Glycol Solutions Temperature Difference, °F [°C]
 Δt_{adb} - Air Dry Bulb Temperature Difference, °F [°C]
 Reference A1.12
 Reference A1.6



Also for H₂O:
 $M = \frac{\Delta t_w}{\Delta t_{adb}} = \frac{4.5 Q_{aSTD} c_p}{W_w c_{pw}} \left[\frac{1.2 Q_{aSTD} c_p}{W_w c_{pw}} \right]$

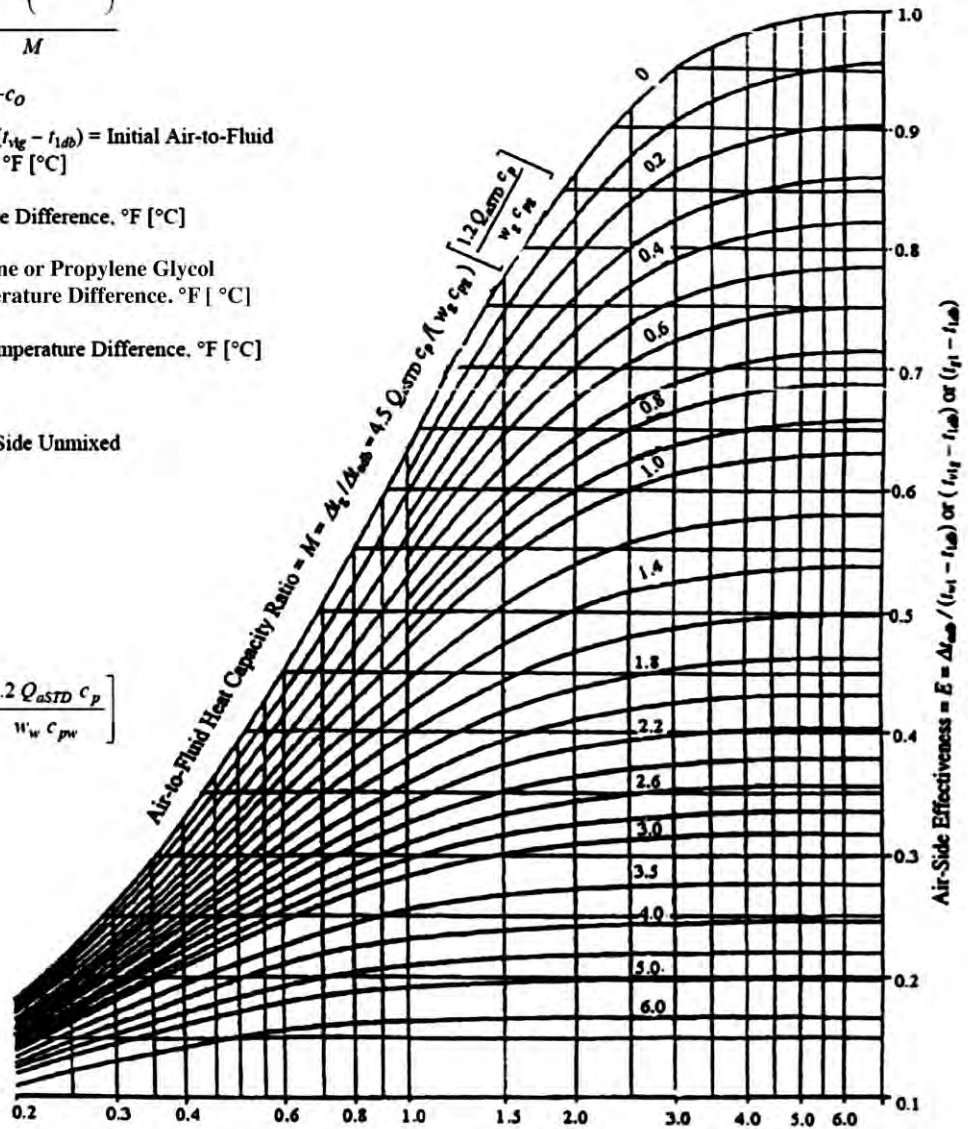

Sensible Heat Transfer Exponent = $c_o = A_o / (4.5 c_p Q_{aSTD} R) = \frac{\Delta t_{adb}}{\Delta t_m}$
 $= [A_o / (1.2 c_p Q_{aSTD} R)]$

Figure 13. Crossflow Air-Side Effectiveness

Δt_w - Water Temperature Difference, °F [°C]
 Δt_g - Aqueous Ethylene or Propylene Glycol Solutions Temperature Difference, °F [°C]
 Δt_{adb} - Air Dry-Bulb Temperature Difference, °F [°C]

When $M > 0$:

$$E = \frac{1}{M} \left(1 - \left(\frac{e^{-M(1-e^{-c_o/2})}}{\cosh(M(1-e^{-c_o/2}))} + e^{(c_o/2)} \sinh(M(1-e^{-c_o/2}))} \right) \right)$$

When $M = 0$: $E = 1 - e^{-c_o}$

$(t_{w1} - t_{1db}), (t_{g1} - t_{1db}),$ or $(t_{wg} - t_{1db}) =$
 Initial Air-to-Fluid Temperature Difference, °F [°C]

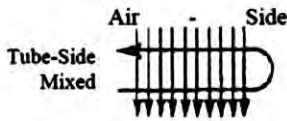

Reference A1.17

Also for H₂O:

$$M = \Delta t_w / \Delta t_{adb} = \frac{4.5 Q_{aSTD} c_p}{W_w c_{pw}} \left[\frac{1.2 Q_{aSTD} c_p}{W_g c_{pg}} \right]$$

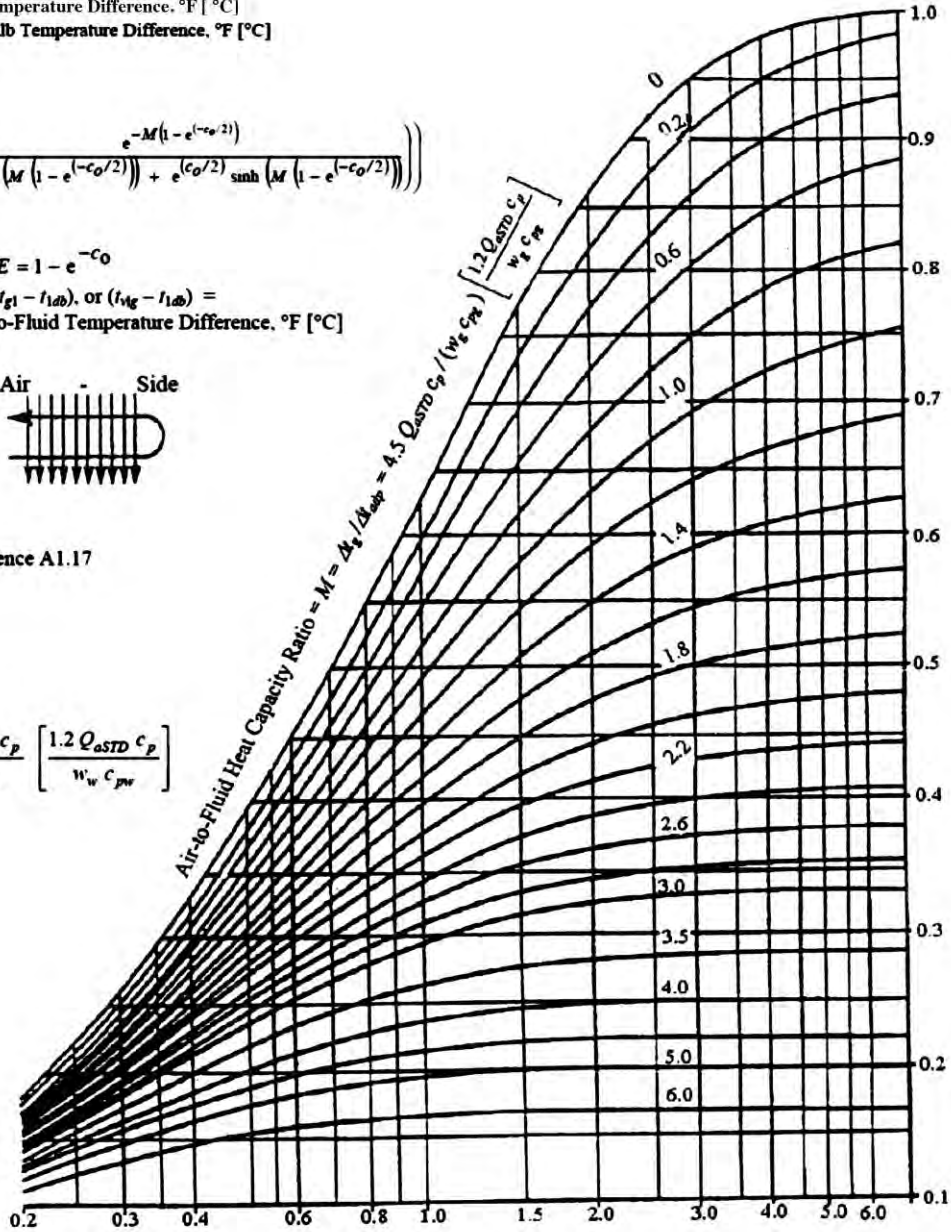

Air-Side Effectiveness = $E = \Delta t_{adb} / (t_{w1} - t_{1db})$ or $(t_{g1} - t_{1db})$ or $(t_{wg} - t_{1db})$

$$\text{Sensible Heat Transfer Exponent } = c_o = A_o / (4.5 c_p Q_{aSTD} R) = \frac{\Delta t_{adb}}{\Delta t_m} = [A_o / (1.2 c_p Q_{aSTD} R)]$$

Figure 14. Cross-Counterflow Air-Side Effectiveness

When $M \neq 1$: $E = \frac{1 - e^{-c_o(1-M)}}{1 - Me^{-c_o(1-M)}}$

When $M = 1$: $E = \frac{c_o}{c_o + 1}$

$(t_{w1} - t_{1db}), (t_{g1} - t_{1db}),$ or $(t_{vg1} - t_{1db}) =$ Initial Air-to-Fluid Temperature Difference, °F [°C]

Δt_w - Water Temperature Difference, °F [°C]

Δt_g - Aqueous Ethylene or Propylene Glycol Solutions Temperature Difference, °F [°C]

Δt_{adb} - Air Dry-Bulb Temperature Difference, °F [°C]

Reference A1.12

Also for H₂O:

$$M = \frac{\Delta t_w}{\Delta t_{adb}} = \frac{4.5 Q_{aSTD} c_p}{w_w c_{pw}} \left[\frac{1.2 Q_{aSTD} c_p}{w_g c_{pg}} \right]$$

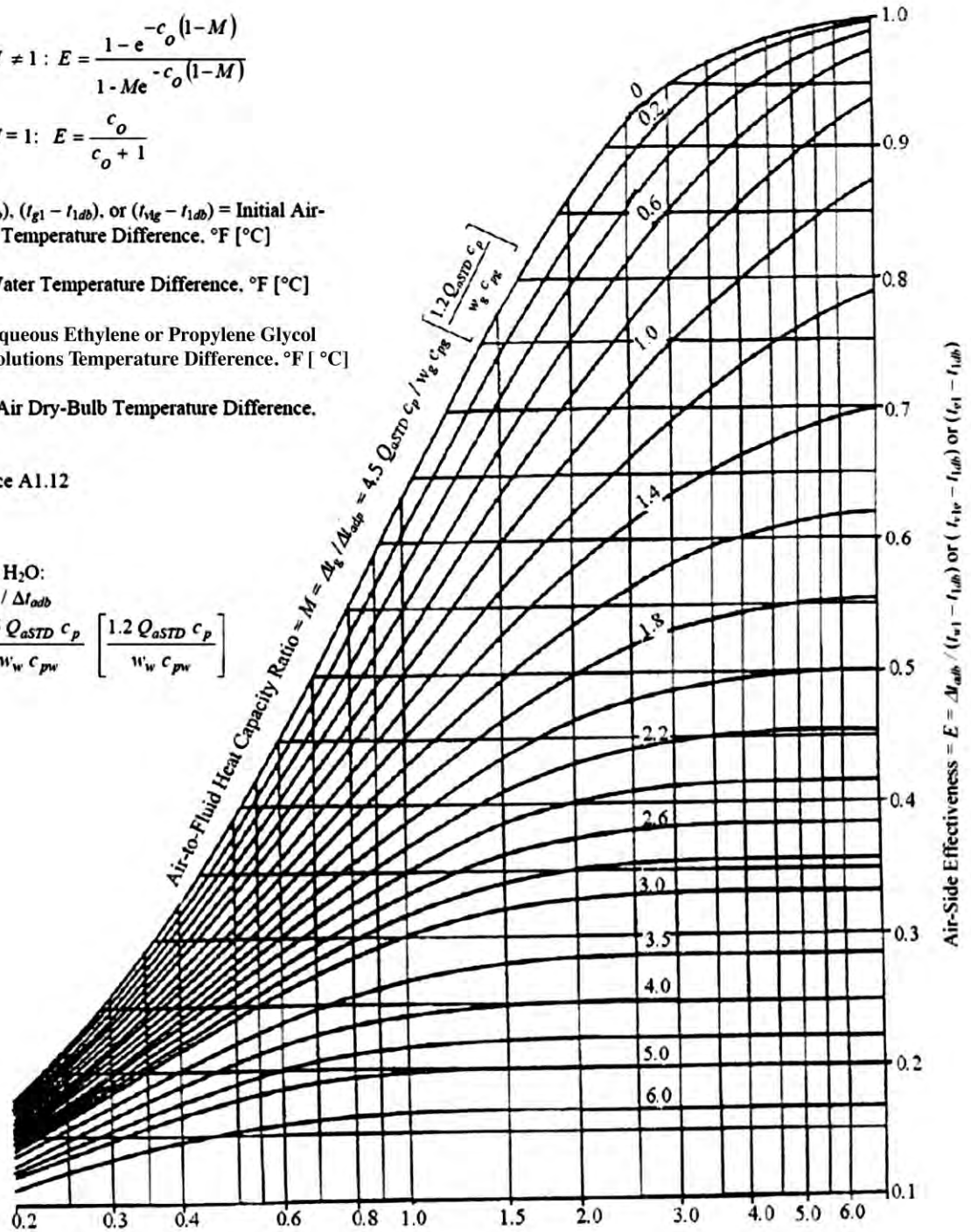

$$\begin{aligned} \text{Sensible Heat Transfer Exponent} = c_o &= A_o / (4.5 c_p Q_{aSTD} R) = \frac{\Delta t_{adb}}{\Delta t_m} \\ &= [A_o / (1.2 c_p Q_{aSTD} R)] \end{aligned}$$

Figure 15. Counterflow Air-Side Effectiveness

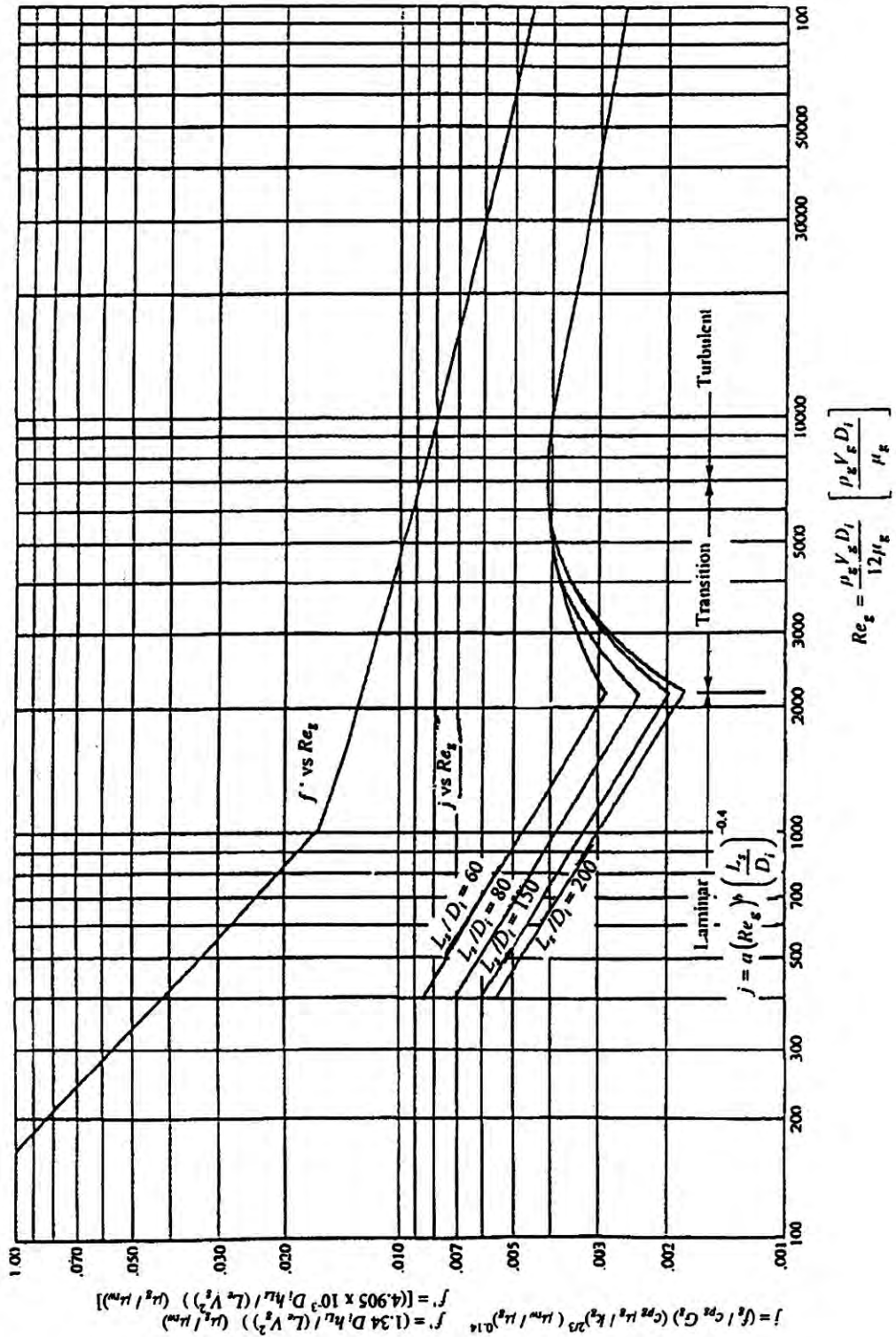

Figure 16. Aqueous Ethylene and Propylene Glycol Solutions Performance for Smooth Internal Wall Tube Coils

Illustrating performance factors as calculated

Nomenclature:

All H₂O properties evaluated @ mean H₂O bulk temperature inside tubes except as noted.

c_{pw} - Specific Heat of H₂O at constant pressure, Btu/(lb °F) [kJ/(kg · °C)]

D_i - Tube Inside Diameter, in [mm]

f_w - H₂O Film Heat Transfer Coefficient, Btu/(h · ft² · °F) [W/(m² · °C)]

G_w - Mass Velocity of H₂O = 224,500 V_w lb/(h · ft²) = 998.927 V_w kg/(s · m²)

k_w - Thermal Conductivity of H₂O, Btu · ft/(h · ft² · °F) [W · mm/(m² · °C)]

L_t - Straight Tube Length per Tube Pass, in [mm]

Pr_w - Prandtl Number = *c_{pw}* *μ_w* / *k_w*

St_w - Stanton Number = *f_w* / (*c_{pw}* · *G_w*)

V_w - Standard H₂O Velocity Inside Tubes, std ft/s [std m/s]

μ_w - Dynamic Viscosity of H₂O, lb/(h · ft) [mPa · s]

μ_w - Dynamic Viscosity of H₂O @ Average Tube Wall Temp, lb/(h · ft) [mPa · s]

Curve Equation 8

$$\ln f_w = A1 + A2 \ln Re_w + A3 (\ln Re_w)^2 + [A4 + A5 \ln Re_w + A6 (\ln Re_w)^2] \cdot \ln (L_t/D_i)$$

Re _w < 2100	A1 = 0.620576	A2 = -0.666666	A3 = 0.0	A4 = -0.333333	A5 = 0.0	A6 = 0.0
2100 ≤ Re _w < 10000	A1 = 23.9147	A2 = -6.2352	A3 = 0.329875	A4 = -1.359	A5 = 2.46100	A6 = -0.13330
10000 ≤ Re _w	A1 = -5.2036	A2 = 0.073562	A3 = -0.01184	A4 = 0.0	A5 = 0.0	A6 = 0.0

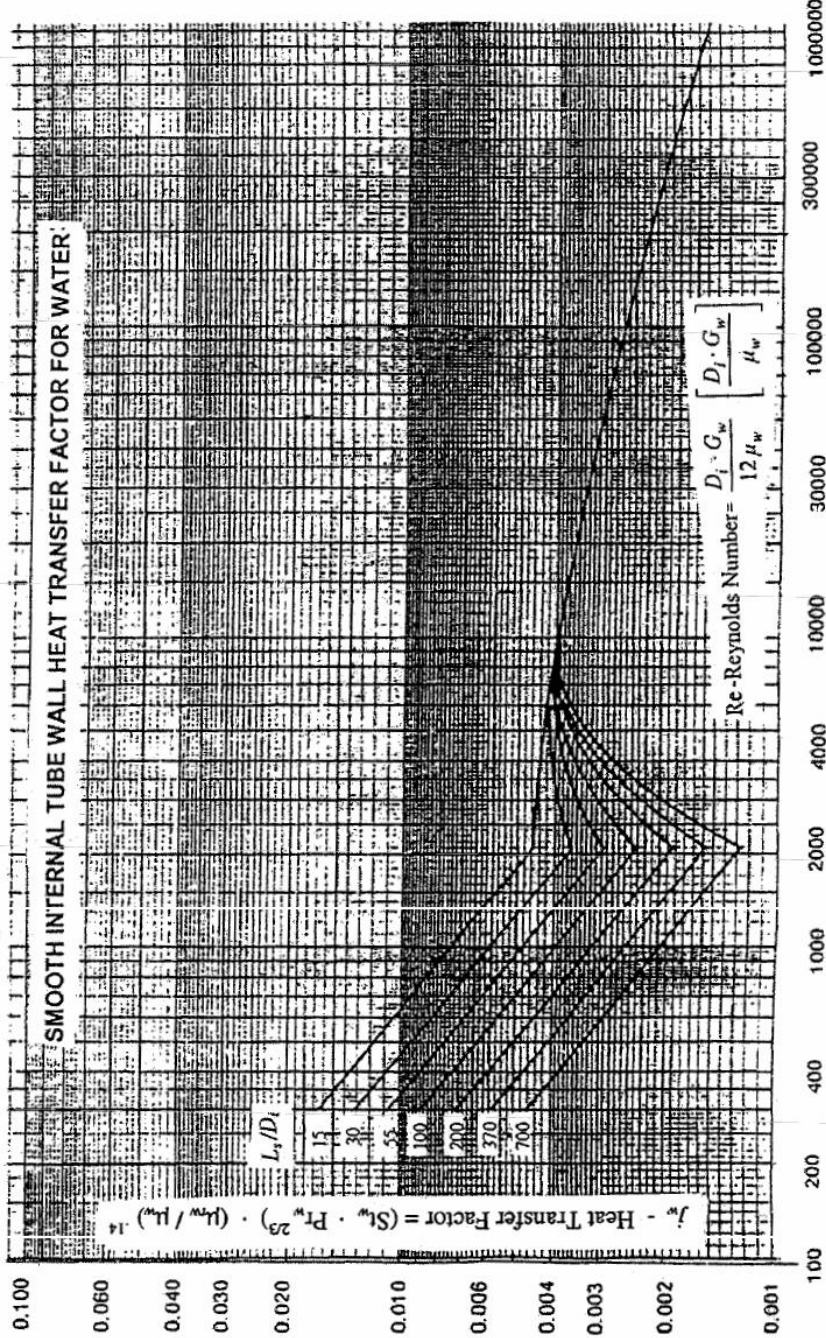

Figure 17. Smooth Internal Tube Wall Heat Transfer Factor for Water

APPENDIX A. REFERENCES – NORMATIVE

A1 Listed here are all standards, handbooks and other publications essential to the formation and implementation of the standard. All references in this appendix are considered as part of the standard.

A1.1 AHRI Guideline E, *Fouling Factors: A Survey of Their Application in Today's Air-Conditioning and Refrigeration Industry*, 1997 (formerly ARI Guideline E), Air Conditioning Heating and Refrigeration Institute, 2111 Wilson Blvd., Suite 500, Arlington, VA 22201, U.S.A.

A1.2 AHRI OM-410 Addendum, *Certification Program Operational Manual for Forced-Circulation Air-Cooling and Air-Heating Coils*, 1981 (formerly ARI OM-410), Air-Conditioning Heating and Refrigeration Institute, 2111 Wilson Blvd., Suite 500, Arlington, VA 22201, U.S.A.

A1.3 ANSI/ASHRAE Standard 33-2000, *Methods of Testing Forced Circulation Air Cooling and Air Heating Coils*, 2000, American Society of Heating, Refrigerating and Air Conditioning Engineers, Inc., 1791 Tullie Circle, N.E., Atlanta, GA 30329, U.S.A.

A1.4 ASHRAE Handbook – Fundamentals, Chapter 6, "Psychrometrics", Chapter 20, "Thermophysical Properties of Refrigerants" and Chapter 21 "Physical Properties of Secondary Coolants (Brines)", 2001, American Society of Heating, Refrigerating and Air-Conditioning Engineers, Inc., 1791 Tullie Circle, N.E., Atlanta, GA 30329, U.S.A.

A1.5 ASHRAE Terminology of Heating Ventilation, Air Conditioning and Refrigeration, Second Edition, 1991, American Society of Heating, Refrigerating, and Air-Conditioning Engineers, Inc., 1791 Tullie Circle, N.E., Atlanta, GA, 30329, U.S.A.

A1.6 Blast Coil Manufacturers Institute, *Proposed Commercial Standard for Rating and Testing Air Cooling Coils Using Non-Volatile Refrigerant*, 1945, BCMI Code TS-4044.

A1.7 Brown, Gosta, *Theory of Moist Air Heat Exchangers*, 1954, Trans. Royal Institute of Technology, Stockholm, Sweden, Pages 12-15, Nr 77.

A1.8 Carrier, W.H. & Anderson S.W., *The Resistance to Heat Flow Through Finned Tubing*, 1944, ASHVE Transactions, Pages 117-152, Vol. 50, American Society of Heating, Refrigeration, and Air-Conditioning Engineers, Inc., 1791 Tullie Circle, N.E., Atlanta, GA, 30329, U.S.A.

A1.9 Copper Development Association, Inc., *Standards Handbook, Part 2-Alloy Data*, 1985, 260 Madison Ave., New York, NY 10016, U.S.A.

A1.10 Gardner, K.A., *Efficiency of Extended Surface*, 1945, ASME Transactions, Pages 621-631, Vol. 67, American Society of Mechanical Engineers, Three Park Ave., New York, NY 10016, U.S.A.

A1.11 International Nickel Co. Inc., *Properties of Some Metals and Alloys*, 1982, Suffern, NY 10901, U.S.A.

A1.12 Kays, W.M., London, A.L., & Johnson D.W., *Gas Turbine Plant Heat Exchangers*, 1951, American Society of Mechanical Engineers, Three Park Ave., New York, NY 10016, U.S.A.

A1.13 Keenan, J.H., Keyes, F.G., Hill, P.G., & Moore, J.G., *Thermodynamic Properties of Water Including Vapor, Liquid, and Solid Phases*, 1969 I-P version, John Wiley & Sons, Inc.

A1.14 Keenan, J.H., Keyes, F.G., Hill, P.G., & Moore, J.G., *Thermodynamic Properties of Water Including Vapor, Liquid, and Solid Phases*, 1978 SI version, John Wiley & Sons, Inc.

A1.15 McElgin, John & Wiley, D.C., *Calculation of Coil Surface Areas for Air Cooling and Dehumidification*, March 1940, Heating, Piping and Air Conditioning, Pages 195-201.

A1.16 Rich, D.G., *The Efficiency and Thermal Resistance of Annular Fins*, 1966, Proceedings of the Third International Heat Transfer Conference, Vol. III, Pages 281-289, American Institute of Chemical Engineers, 345 East 47th Street, New York, NY 10017, U.S.A.

A1.17 Stevens, R.A., Fernandez, J., & Woolf, J.R., *Mean Temperature Difference in One, Two and Three-Pass Crossflow Heat Exchangers*, 1957, ASME Transactions, Pages 287-297, Vol. 79, American Society of Mechanical Engineers, Three Park Ave., New York, NY 10016, U.S.A.

A1.18 Ware, C.D. & Hacha, T.H., *Heat Transfer From Humid Air to Fin and Tube Extended Surface Cooling Coils*, 1960, ASME Paper No. 60-HT-17, American Society of Mechanical Engineers, Three Park Ave., New York, NY 10016, U.S.A.

APPENDIX B. REFERENCES – INFORMATIVE

B1 Listed here are standards, handbooks and other publications which may provide useful information and background, but are not considered essential. References in this appendix are not considered part of the standard.

B1.1 Goodman, W., *Performance of Coils for Dehumidifying Air*, 1938 & 1939, Heating, Piping and Air Conditioning, Vol. 10 (Nov.-Dec. 1938), Vol. 11 (Jan.-May 1939).

B1.2 Wile, D.D., *Air Cooling Coil Performance*, July 1953, Refrigerating Engineering, Pages 727-732, 794, 796, Vol. 61. American Society of Heating, Refrigeration, and Air-Conditioning Engineers, Inc., 1791 Tullie Circle, N.E., Atlanta, GA, 30329, U.S.A.